

**技术特性/Specifications:**

额定电压 Rated voltage: 50V AC, DC  
额定电流 Rated current: 1A AC, DC  
接触电阻 Contact resistance: 20m $\Omega$  max  
绝缘电阻 Insulation resistance: 100M $\Omega$  min  
耐压 Withstand voltage: 250V AC/minute  
环境温度 Ambient temperature: -40 $^{\circ}$ C~+105 $^{\circ}$ C  
适用线规 Wire range: AWG#32~#28

REV.	REVISION DESCRIPTION	DATE	APPD

NOTES

Available in 02 through 15 Circuits.  
Mates with DL10002-Y Series Housing.  
Material :LCP UL94V-0.  
Material : Phosphor Bronze.  
Finish : Tin-plated.

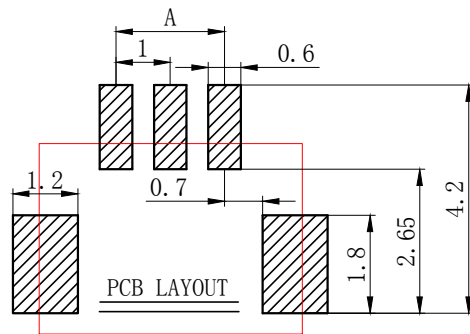
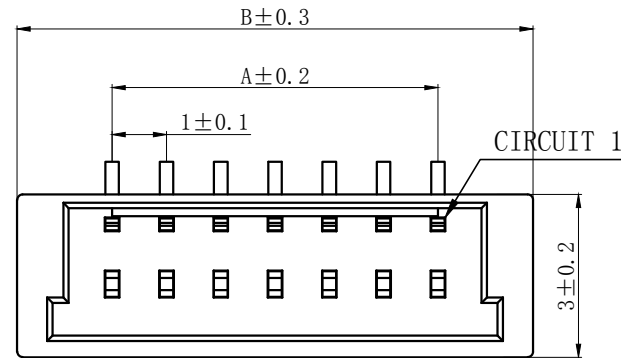
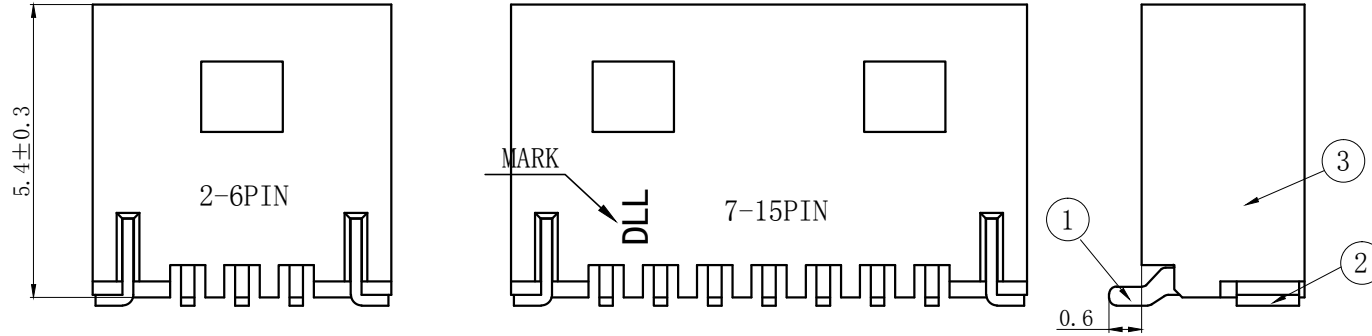

3	③	基座	LCP	1	UL94V-0
2	②	焊片	黄铜	2	镀锡
1	①	接触件	磷青铜	N*	镀锡
序号	图号	名称	材料	数量	附件

Circuits	Product name	Dimension mm		Circuits	Product name	Dimension mm	
		A	B			A	B
2	501330-2AB	1.0	4.5	9	501330-9AB	8.0	11.5
3	501330-3AB	2.0	5.5	10	501330-10AB	9.0	12.5
4	501330-4AB	3.0	6.5	11	501330-11AB	10.0	13.5
5	501330-5AB	4.0	7.5	12	501330-12AB	11.0	14.5
6	501330-6AB	5.0	8.5	13	501330-13AB	12.0	15.5
7	501330-7AB	6.0	9.5	14	501330-14AB	13.0	16.5
8	501330-8AB	7.0	10.5	15	501330-15AB	14.0	17.5

GENERAL TOLERANCES (UNLESS SPECIFIED)		ZHE JIANG DELI CONNECTORS CO., LTD			
.X: ± 0.25	X°: ± 3.0°	PRODUCT NAME: DL10002 (501330)-AB		TITLE: 1.0mm Pitch Wire To Board SMT Wafer	
.XX: ± 0.15	.X°: ± 2.0°	DR:Chen Quan Long	DATE:20.10.12	PART NO:	
.XXX: ± 0.01	.XX°: ± 1.0°	CHKD: Wu Hui	DATE:20.10.12	SCALE: N/A	PAGE: 1/1
DRAWING NO:		APPD:Ren An De	DATE:20.10.12	UNITS: mm	REV.: A

REV.	REVISION DESCRIPTION	DATE	APPD

### NOTES

Available in 02 through 15 Circuits.  
 Mates with DL10002-Y Series Housing.  
 Material :LCP UL94V-0.  
 Material : Phosphor Bronze.  
 Finish : Tin-plated.

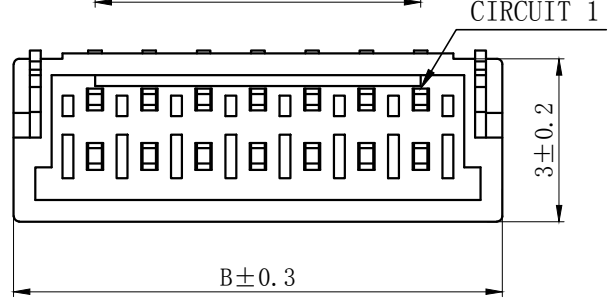
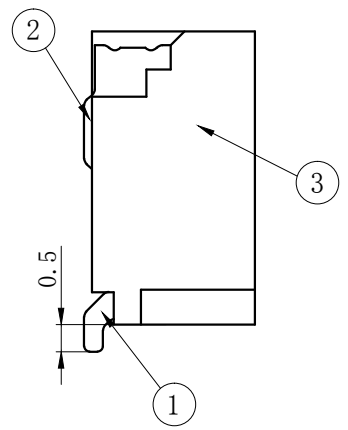
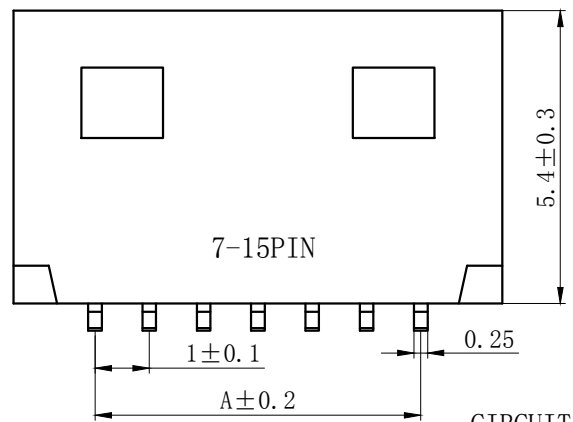
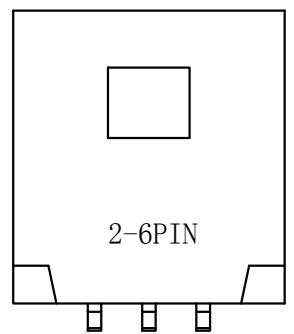

3	③	基座	LCP	1	UL94-V0
2	②	焊片	黄铜	2	镀锡
1	①	接触件	磷青铜	N*	镀锡
序号	图号	名称	材料	数量	附件

Circuits	Product name	Dimension mm		Circuits	Product name	Dimension mm	
		A	B			A	B
2	501330-2AWB	1.0	4.0	9	501330-9AWB	8.0	11.0
3	501330-3AWB	2.0	5.0	10	501330-10AWB	9.0	12.0
4	501330-4AWB	3.0	6.0	11	501330-11AWB	10.0	13.0
5	501330-5AWB	4.0	7.0	12	501330-12AWB	11.0	14.0
6	501330-6AWB	5.0	8.0	13	501330-13AWB	12.0	15.0
7	501330-7AWB	6.0	9.0	14	501330-14AWB	13.0	16.0
8	501330-8AWB	7.0	10.0	15	501330-15AWB	14.0	17.0

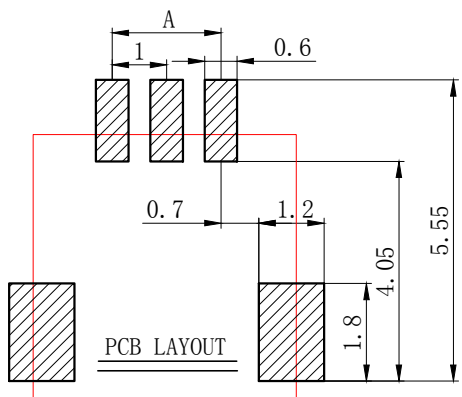

GENERAL TOLERANCES (UNLESS SPECIFIED)		ZHE JIANG DELI CONNECTORS CO., LTD			
.X: ± 0.25	X°: ± 3.0°	PRODUCT NAME: DL10002(501330)-AWB		TITLE: 1.0mm Pitch Wire To Board SMT Wafer	
.XX: ± 0.15	.X°: ± 2.0°	DR: Chen Quan Long	DATE:20.10.12	PART NO:	
.XXX: ± 0.01	.XX°: ± 1.0°	CHKD: Wu Hui	DATE:20.10.12	SCALE: N/A	PAGE: 1/1
DRAWING NO:		APPD: Ren An De	DATE:20.10.12	UNITS: mm	REV.: A

REV.	REVISION DESCRIPTION	DATE	APPD

### NOTES

Available in 02 through 15 Circuits.

Match with DL10002 series housing.

Material : Nylon UL94V-0(2).

Accepts DL10002-T Crimp Terminal.

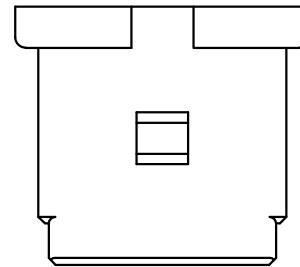
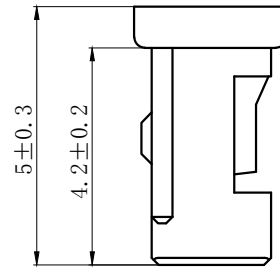
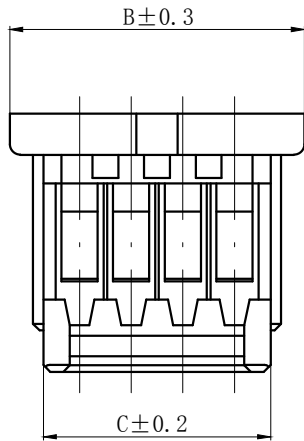
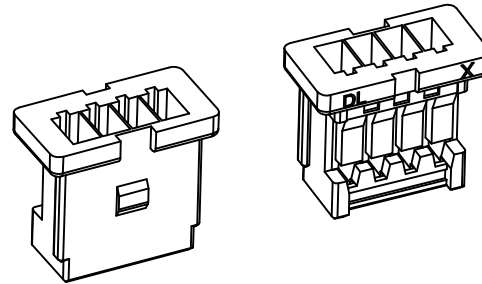
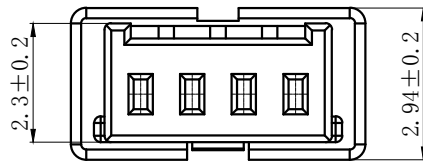

2-6PIN

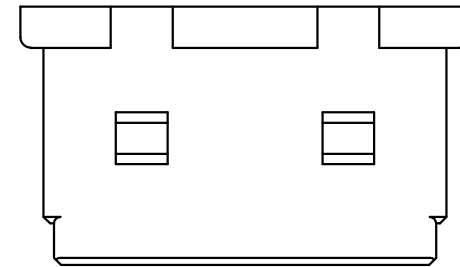

7-15PIN

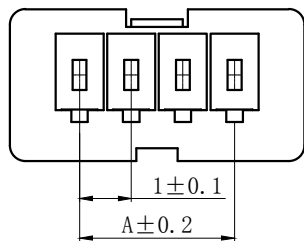

Circuits	Product name	Dimension mm			Circuits	Product name	Dimension mm		
		A	B	C			A	B	C
2	501330-2Y	1.0	3.7	2.4	10	501330-10Y	9.0	11.7	10.4
3	501330-3Y	2.0	4.7	3.4	11	501330-11Y	10.0	12.7	11.4
4	501330-4Y	3.0	5.7	4.4	12	501330-12Y	11.0	13.7	12.4
5	501330-5Y	4.0	6.7	5.4	13	501330-13Y	12.0	14.7	13.4
6	501330-6Y	5.0	7.7	6.4	14	501330-14Y	13.0	15.7	14.4
7	501330-7Y	6.0	8.7	7.4	15	501330-15Y	14.0	16.7	15.4
8	501330-8Y	7.0	9.7	8.4	-	-	-	-	-
9	501330-9Y	8.0	10.7	9.4	-	-	-	-	-

GENERAL TOLERANCES (UNLESS SPECIFIED)		ZHE JIANG DELI CONNECTORS CO., LTD			
.X: ± 0.25	X°: ± 3.0°	PRODUCT NAME: DL10002 (501330)-Y		TITLE: 1.0mm Pitch Housing	
.XX: ± 0.15	.X°: ± 2.0°	DR: Chen Quan Long		DATE: 20/10/12	
.XXX: ± 0.01	.XX°: ± 1.0°	CHKD: Wu Hui		DATE: 20/10/12	
DRAWING NO:		APPD: Ren An De		DATE: 20/10/12	
FINISH:		SCALE: N/A		PAGE: 1/1	
UNITS: mm		REV.: A		PART NO:	

REV.	REVISION DESCRIPTION	DATE	APPD

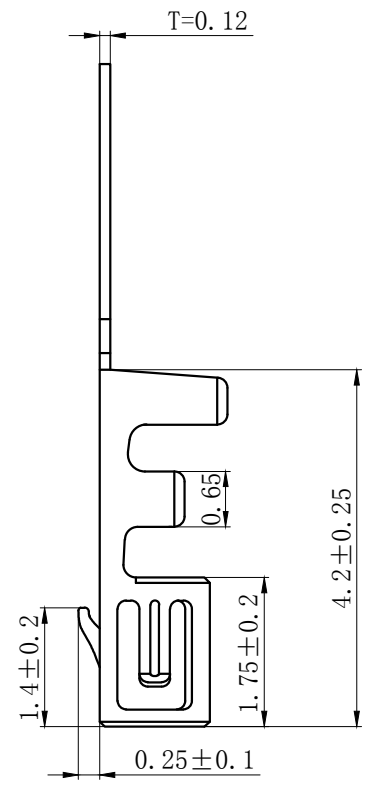
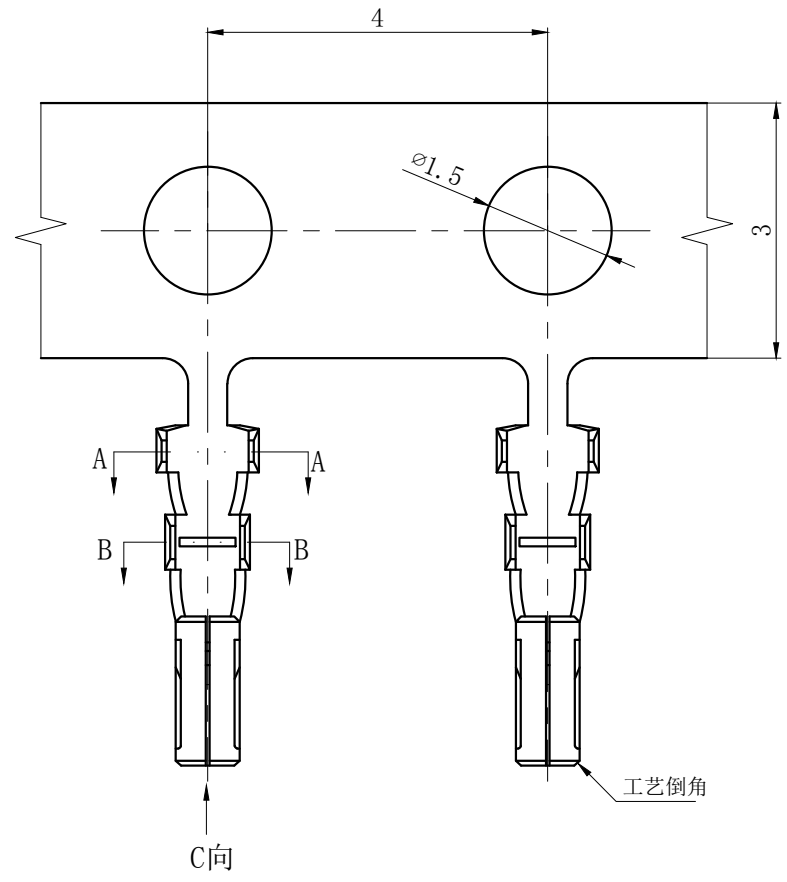

### NOTES

Used in DL10002-Y Series Housing.  
 Accepts AWG #32~28 Wire Range.  
 Insulation O.D.=0.4~0.8 mm.  
 Material : Phosphor Bronze .  
 Finish: Tin plated.  
 Thickness: 0.12 mm.

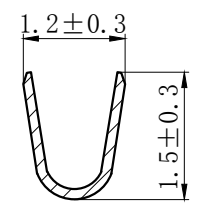

SECTION A-A

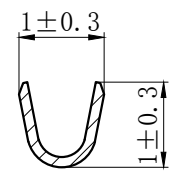

SECTION B-B

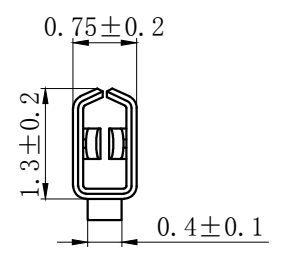

SECTION C-C

GENERAL TOLERANCES (UNLESS SPECIFIED)		ZHE JIANG DELI CONNECTORS CO., LTD	
.X: ± 0.25	X° : ± 3.0°	PRODUCT NAME: <b>DL10002(501330)-T</b>	TITLE: 1.0mm Pitch Crimp Terminal
.XX: ± 0.15	.X° : ± 2.0°	DR: Chen Quan Long	DATE:20/10/12
.XXX: ± 0.01	.XX° : ± 1.0°	CHKD: Wu Hui	DATE:20/10/12
FINISH:		APPD: Ren An De	DATE:20/10/12
DRAWING NO:		SCALE: N/A	PAGE: 1/1
		UNITS: mm	REV.: A

## X-ON Electronics

Largest Supplier of Electrical and Electronic Components

*Click to view similar products for [Headers & Wire Housings](#) category:*

*Click to view products by [DLL](#) manufacturer:*

Other Similar products are found below :

[0015917161](#) [0022155065](#) [57102-F02-18ULF](#) [58102-G61-06LF](#) [582553-1](#) [01.001.5753.1](#) [0050291907](#) [02.125.8002.8](#) [609-3404](#) [61062-3](#)  
[CSU011177004](#) [622-0430](#) [622-3653LF](#) [63453-116](#) [636-1030](#) [636-1427](#) [636-3427](#) [636-4007](#) [641938-9](#) [65495-038](#) [65692-001LF](#) [65781-018](#)  
[65781-047](#) [65817-010LF](#) [65817-015LF](#) [67095-007LF](#) [67601157](#) [68631-112](#) [68645-018](#) [699319-000](#) [70.362.1628.0](#) [70-4210](#) [70-4226B](#) [70-](#)  
[4853B](#) [71.350.2428.0](#) [733-134](#) [733-162](#) [MHR-64-VUAL](#) [80.063.4001.1](#) [800-90-001-10-001000](#) [801-43-002-10-013000](#) [801-43-006-10-](#)  
[002000](#) [803-43-024-10-001000](#) [803-93-012-10-001000](#) [8-1437020-4](#) [819-22-004-30-001101](#) [820-22-006-30-001101](#) [820-22-008-30-001101](#)  
[821-22-002-10-001101](#) [821-22-003-10-002101](#)