

技术特性/Specifications:

额定电压 Rated voltage: 250V AC, DC
额定电流 Rated current: 3A AC, DC
接触电阻 Contact resistance: 20m Ω max
绝缘电阻 Insulation resistance: 1000M Ω min
耐压 Withstand voltage: 1000V AC/minute
环境温度 Ambient temperature: -40 $^{\circ}$ C~+105 $^{\circ}$ C
适用线规 Wire range: AWG#28~#22

REV.	REVISION DESCRIPTION	DATE	APPD



NOTES

Available in 02 through 20 Circuits.
 Mates with DL25013-Y Series Housing.
 Material : Nylon UL94V-0(2).
 0.7mm Square Pin.
 Pin Material : Brass / Tin-Plated.



Circuits	Type	Dimensino (mm)			Circuits	Type	Dimensino (mm)		
		A	B	C			A	B	C
2	5264-2A	2.5	7.4	6.1	12	5264-12A	27.5	32.4	31.1
3	5264-3A	5.0	9.9	8.6	13	5264-13A	30.0	34.9	33.6
4	5264-4A	7.5	12.4	11.1	14	5264-14A	32.5	37.4	36.1
5	5264-5A	10.0	14.9	13.6	15	5264-15A	35.0	39.9	38.6
6	5264-6A	12.5	17.4	16.1	16	5264-16A	37.5	42.4	41.1
7	5264-7A	15.0	19.9	18.6	17	5264-17A	40.0	44.9	43.6
8	5264-8A	17.5	22.4	21.1	18	5264-18A	42.5	47.4	46.1
9	5264-9A	20.0	24.9	23.6	19	5264-19A	45.0	49.9	48.6
10	5264-10A	22.5	27.4	26.1	20	5264-20A	47.5	52.4	51.1
11	5264-11A	25.0	29.9	28.6					

GENERAL TOLERANCES (UNLESS SPECIFIED)		ZHE JIANG DELI CONNECTORS CO., LTD			
.X: ±0.25	X°: ±3.0°	PRODUCT NAME: DL25013(5264)-A		TITLE: 2.50 mm Pitch Wire To Board Wafer	
.XX: ±0.15	.X°: ±2.0°	DR: Yuan Jun Rong	DATE:21/03/05	PART NO:	
.XXX: ±0.01	.XX°: ±1.0°	CHKD: Liu Bing	DATE:21/03/05	SCALE: N/A	PAGE: 1/1
DRAWING NO:		APPD:Ren An De	DATE:21/03/05	UNITS: mm	REV.: A

REV.	REVISION DESCRIPTION	DATE	APPD

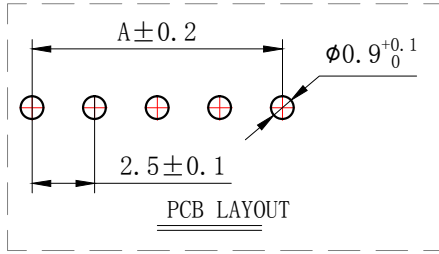
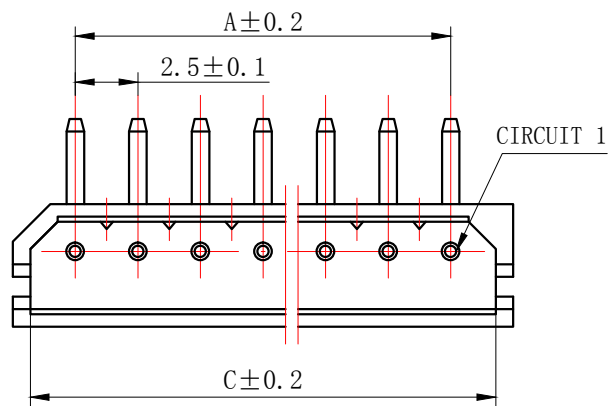

NOTES

Available in 02 through 20 Circuits.
 Mates with DL25013-Y Series Housing.
 Material : Nylon UL94V-0(2).
 0.7mm Square Pin.
 Pin Material : Brass / Tin-Plated.

Circuits	Type	Dimensino (mm)			Circuits	Type	Dimensino (mm)		
		A	B	C			A	B	C
2	5264-2AW	2.5	7.4	6.1	12	5264-12AW	27.5	32.4	31.1
3	5264-3AW	5.0	9.9	8.6	13	5264-13AW	30.0	34.9	33.6
4	5264-4AW	7.5	12.4	11.1	14	5264-14AW	32.5	37.4	36.1
5	5264-5AW	10.0	14.9	13.6	15	5264-15AW	35.0	39.9	38.6
6	5264-6AW	12.5	17.4	16.1	16	5264-16AW	37.5	42.4	41.1
7	5264-7AW	15.0	19.9	18.6	17	5264-17AW	40.0	44.9	43.6
8	5264-8AW	17.5	22.4	21.1	18	5264-18AW	42.5	47.4	46.1
9	5264-9AW	20.0	24.9	23.6	19	5264-19AW	45.0	49.9	48.6
10	5264-10AW	22.5	27.4	26.1	20	5264-20AW	47.5	52.4	51.1
11	5264-11AW	25.0	29.9	28.6					

GENERAL TOLERANCES (UNLESS SPECIFIED)		ZHE JIANG DELI CONNECTORS CO., LTD	
.X: ±0.25	X°: ±3.0°	PRODUCT NAME: DL25013 (5264)-AW	TITLE: 2.50 mm Pitch Wire To Board Wafer
.XX: ±0.15	.X°: ±2.0°	DR: Yuan Jun Rong	DATE: 21/03/05
.XXX: ±0.01	.XX°: ±1.0°	CHKD: Liu Bing	DATE: 21/03/05
FINISH:		APPD: Ren An De	DATE: 21/03/05
DRAWING NO:		PART NO:	
		SCALE: N/A	PAGE: 1/1
		UNITS: mm	REV.: A

REV.	REVISION DESCRIPTION	DATE	APPD

NOTES

Available in 02 through 20 Circuits.
 Mates with DL25013-Y Series Housing.
 Material : Nylon UL94V-0(2).
 0.7mm Square Pin.
 Pin Material : Brass / Tin-Plated.

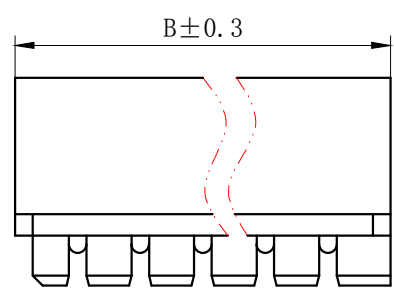

Circuits	Type	Dimensino (mm)			Circuits	Type	Dimensino (mm)		
		A	B	C			A	B	C
2	5264-2AWD	2.5	7.4	6.1	12	5264-12AWD	27.5	32.4	31.1
3	5264-3AWD	5.0	9.9	8.6	13	5264-13AWD	30.0	34.9	33.6
4	5264-4AWD	7.5	12.4	11.1	14	5264-14AWD	32.5	37.4	36.1
5	5264-5AWD	10.0	14.9	13.6	15	5264-15AWD	35.0	39.9	38.6
6	5264-6AWD	12.5	17.4	16.1	16	5264-16AWD	37.5	42.4	41.1
7	5264-7AWD	15.0	19.9	18.6	17	5264-17AWD	40.0	44.9	43.6
8	5264-8AWD	17.5	22.4	21.1	18	5264-18AWD	42.5	47.4	46.1
9	5264-9AWD	20.0	24.9	23.6	19	5264-19AWD	45.0	49.9	48.6
10	5264-10AWD	22.5	27.4	26.1	20	5264-20AWD	47.5	52.4	51.1
11	5264-11AWD	25.0	29.9	28.6					



GENERAL TOLERANCES (UNLESS SPECIFIED)		ZHE JIANG DELI CONNECTORS CO., LTD			
.X: ±0.25	X°: ±3.0°	PRODUCT NAME: DL25013 (5264)-AWD		TITLE: 2.50 mm Pitch Wire To Board Wafer	
.XX: ±0.15	.X°: ±2.0°	DR: Yuan Jun Rong	DATE: 21/03/05	PART NO:	
.XXX: ±0.01	.XX°: ±1.0°	CHKD: Liu Bing	DATE: 21/03/05	SCALE: N/A	PAGE: 1/1
DRAWING NO:		APPD: Ren An De	DATE: 21/03/05	UNITS: mm	REV.: A

REV.	7	REVISION DESCRIPTION	8	DATE	APPD

NOTES

Available in 02 through 20 Circuits.
 Mates with DL25013-A or
 DL25013-AW or DL25013-AWD Series WAFER.

Material : Nylon UL94V-0(2).

Accepts DL25013-T Crimp Terminal.

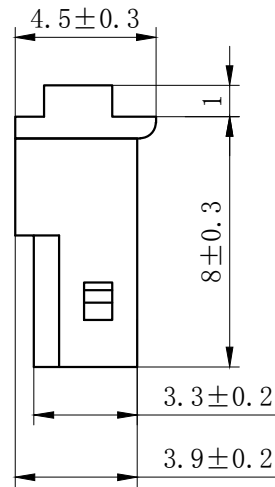
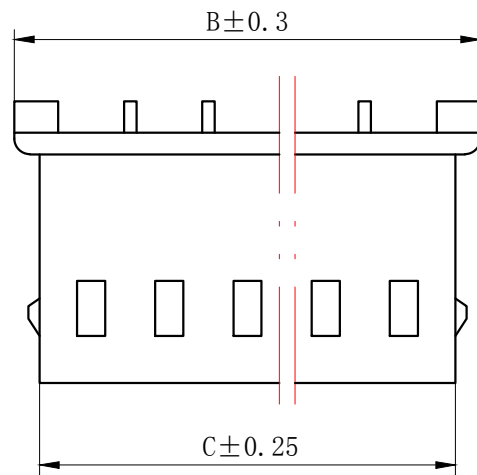
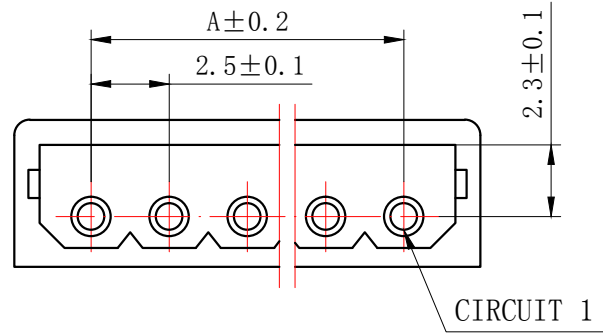

Circuits	Type	Dimensino (mm)			Circuits	Type	Dimensino (mm)		
		A	B	C			A	B	C
2	5264-2Y	2.50	7.50	5.80	12	5264-12Y	27.50	32.50	30.80
3	5264-3Y	5.00	10.00	8.30	13	5264-13Y	30.00	35.00	33.30
4	5264-4Y	7.50	12.50	10.80	14	5264-14Y	32.50	37.50	35.80
5	5264-5Y	10.00	15.00	13.30	15	5264-15Y	35.00	40.00	38.30
6	5264-6Y	12.50	17.50	15.80	16	5264-16Y	37.50	42.50	40.80
7	5264-7Y	15.00	20.00	18.30	17	5264-17Y	40.00	45.00	43.30
8	5264-8Y	17.50	22.50	20.80	18	5264-18Y	42.50	47.50	45.80
9	5264-9Y	20.00	25.00	23.30	19	5264-19Y	45.00	50.00	48.30
10	5264-10Y	22.50	27.50	25.80	20	5264-20Y	47.50	52.50	50.80
11	5264-11Y	25.00	30.00	28.30					

GENERAL TOLERANCES (UNLESS SPECIFIED)		ZHE JIANG DELI CONNECTORS CO., LTD			
.X: ±0.25	X°: ±3.0°	PRODUCT NAME: DL25013(5264)-Y		TITLE: 2.50 mm Pitch Housing	
.XX: ±0.15	.X°: ±2.0°	DR: Yuan Jun Rong	DATE: 21/03/05	PART NO:	
.XXX: ±0.01	.XX°: ±1.0°	CHKD: Liu Bing	DATE: 21/03/05	SCALE: N/A	PAGE: 1/1
FINISH:		APPD: Ren An De	DATE: 21/03/05	UNITS: mm	REV.: A
DRAWING NO:					

REV.	REVISION DESCRIPTION	DATE	APPD

NOTES

Used in DL25013-Y Series Housing.
 Accepts AWG #28~22 Wire Range.
 0.06~ 0.33 mm² .
 Insulation O.D.=1.2~1.9 mm.
 Material : Phosphor Bronze .
 Finish: Tin plated.
 Thickness: 0.2 mm.

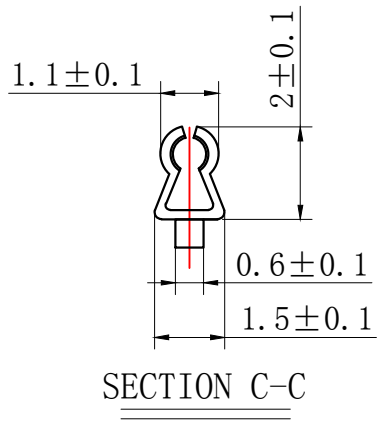
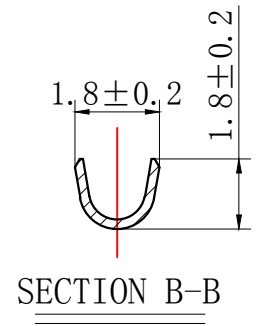
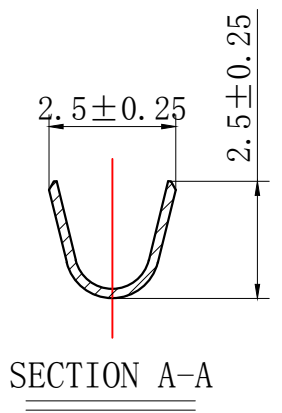

GENERAL TOLERANCES (UNLESS SPECIFIED)		ZHE JIANG DELI CONNECTORS CO., LTD	
.X: ± 0.25	X°: ± 3.0°	PRODUCT NAME: DL25013 (5264)-T	TITLE: 2.50 mm Pitch Crimp Terminal
.XX: ± 0.15	.X°: ± 2.0°	DR: Yuan Jun Rong	DATE: 21/08/01
.XXX: ± 0.01	.XX°: ± 1.0°	CHKD: Wu Hui	DATE: 21/08/01
DRAWING NO:		APPD: Ren An De	DATE: 21/08/01
		SCALE: N/A	PAGE: 1/1
		UNITS: mm	REV.: A

X-ON Electronics

Largest Supplier of Electrical and Electronic Components

Click to view similar products for [Headers & Wire Housings](#) category:

Click to view products by [DLL](#) manufacturer:

Other Similar products are found below :

[0015917161](#) [0022155065](#) [57102-F02-18ULF](#) [58102-G61-06LF](#) [582553-1](#) [01.001.5753.1](#) [0050291907](#) [02.125.8002.8](#) [609-3404](#) [61062-3](#)
[CSU011177004](#) [622-0430](#) [622-3653LF](#) [63453-116](#) [636-1030](#) [636-1427](#) [636-3427](#) [636-4007](#) [641938-9](#) [65495-038](#) [65692-001LF](#) [65781-018](#)
[65781-047](#) [65817-010LF](#) [65817-015LF](#) [67095-007LF](#) [67601157](#) [68631-112](#) [68645-018](#) [699319-000](#) [70.362.1628.0](#) [70-4210](#) [70-4226B](#) [70-](#)
[4853B](#) [71.350.2428.0](#) [733-134](#) [733-162](#) [MHR-64-VUAL](#) [80.063.4001.1](#) [800-90-001-10-001000](#) [801-43-002-10-013000](#) [801-43-006-10-](#)
[002000](#) [803-43-024-10-001000](#) [803-93-012-10-001000](#) [8-1437020-4](#) [819-22-004-30-001101](#) [820-22-006-30-001101](#) [820-22-008-30-001101](#)
[821-22-002-10-001101](#) [821-22-003-10-002101](#)