

技术特性/Specifications:

额定电压 Rated voltage: 300V AC, DC
额定电流 Rated current: 9A AC, DC
接触电阻 Contact resistance: 20m Ω max
绝缘电阻 Insulation resistance: 1000M Ω min
耐压 Withstand voltage: 1500V AC/minute
环境温度 Ambient temperature: -40 $^{\circ}$ C~+105 $^{\circ}$ C
适用线规 Wire range: AWG#28~#16

REV.	REVISION DESCRIPTION	DATE	APPD

NOTES

Available in 02 through 12 Circuits.
 Mates with DL42008-YM Series Housing.
 Material : Nylon UL94V-0 (2) .
 1.14mm Square Pin.
 Pin Material : Brass / Tin-Plated.

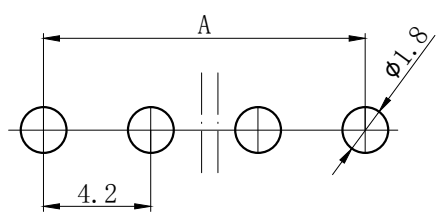
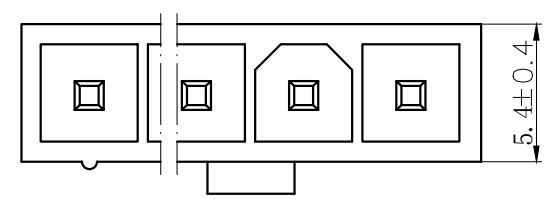
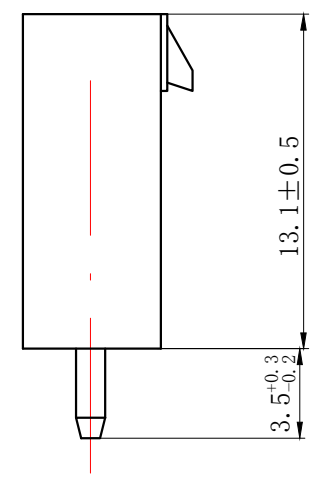
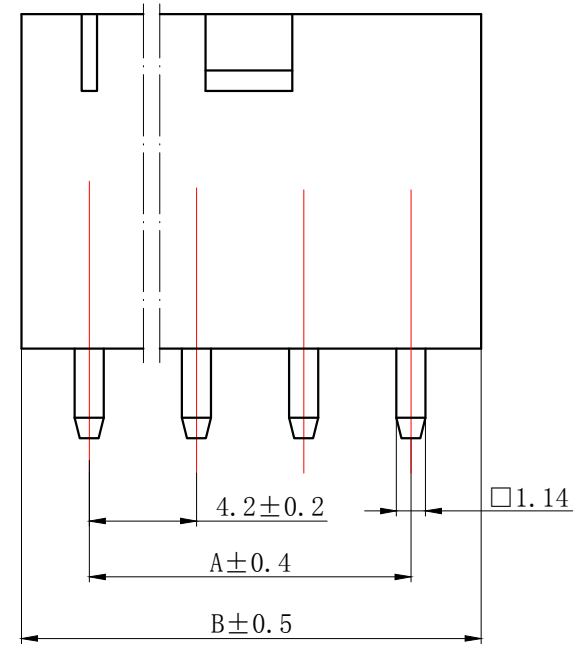

PCB LAYOUT

Circuits	Product name	Dimension mm	
		A	B
2	5569-2AM	4.20	9.60
3	5569-3AM	8.40	13.80
4	5569-4AM	12.60	18.00
5	5569-5AM	16.80	22.20
6	5569-6AM	21.00	26.40
7	5569-7AM	25.20	30.60
8	5569-8AM	29.40	34.80
9	5569-9AM	33.60	39.00
10	5569-10AM	37.80	43.20
11	5569-11AM	42.00	47.40
12	5569-12AM	46.20	51.60

GENERAL TOLERANCES (UNLESS SPECIFIED)		ZHE JIANG DELI CONNECTORS CO ., LTD	
.X: ± 0.25	X° : ± 3.0°	PRODUCT NAME:	TITLE:
.XX: ± 0.15	.X° : ± 2.0°	DL42007 (5569) -AM	4.20 mm Pitch Wire To Board Wafer
.XXX: ± 0.01	.XX° : ± 1.0°	DR: Chen Quan Long	DATE:20/10/10
FINISH:		CHKD: Wu Hui	DATE:20/10/10
DRAWING NO:		APPD:Ren An De	DATE:20/10/10
		SCALE: N/A	PAGE: 1/1
		UNITS: mm	REV.: A

REV.	REVISION DESCRIPTION	DATE	APPD

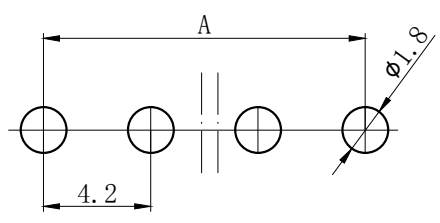
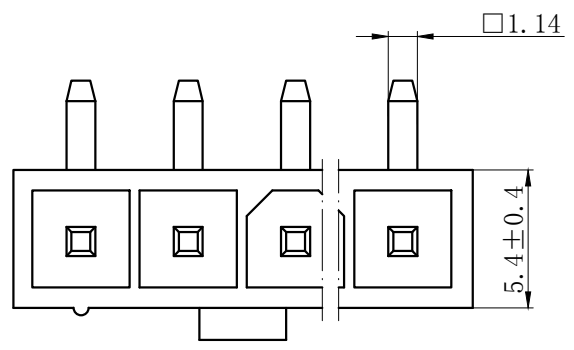
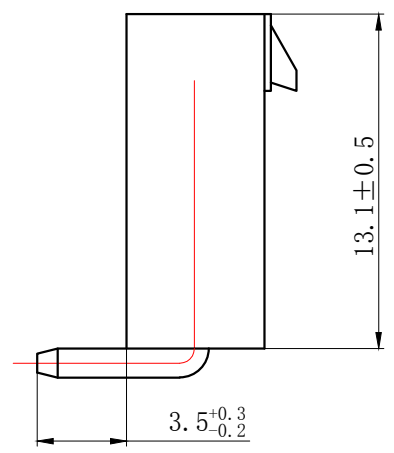
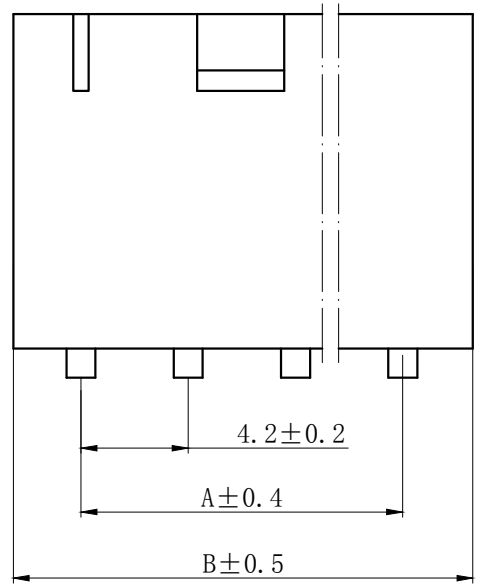

PCB LAYOUT

NOTES

Available in 02 through 12 Circuits.
 Mates with DL42008-YM Series Housing.
 Material : Nylon UL94V-0 (2) .
 1.14mm Square Pin.
 Pin Material : Brass / Tin-Plated.

Circuits	Product name	Dimension mm	
		A	B
2	5569-2AWM	4.20	9.60
3	5569-3AWM	8.40	13.80
4	5569-4AWM	12.60	18.00
5	5569-5AWM	16.80	22.20
6	5569-6AWM	21.00	26.40
7	5569-7AWM	25.20	30.60
8	5569-8AWM	29.40	34.80
9	5569-9AWM	33.60	39.00
10	5569-10AWM	37.80	43.20
11	5569-11AWM	42.00	47.40
12	5569-12AWM	46.20	51.60

GENERAL TOLERANCES (UNLESS SPECIFIED)		ZHE JIANG DELI CONNECTORS CO ., LTD	
.X: ± 0.25	X° : ± 3.0°	PRODUCT NAME: DL42007 (5569)-AWM	TITLE: 4.20 mm Pitch Wire To Board Wafer
.XX: ± 0.15	.X° : ± 2.0°	DR: Chen Quan Long	DATE:20/10/10
.XXX: ± 0.01	.XX° : ± 1.0°	CHKD: Wu Hui	DATE:20/10/10
FINISH:		APPD: Ren An De	DATE:20/10/10
DRAWING NO:		SCALE: N/A	PAGE: 1/1
		UNITS: mm	REV.: A

REV.	7	8
REVISION	DESCRIPTION	DATE

NOTES

Available in 02 through 12 Circuits.
 Mates with DL42008-YM Series Housing.
 Material : Nylon UL94V-0 (2) .
 1.14mm Square Pin.
 Pin Material : Brass / Tin-Plated.

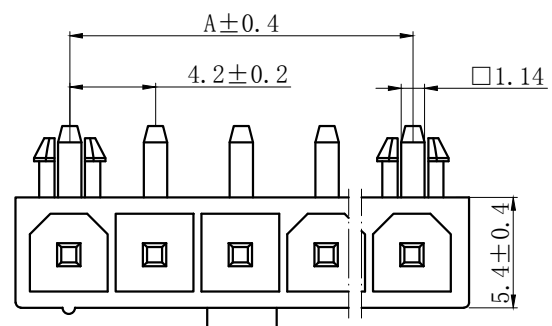
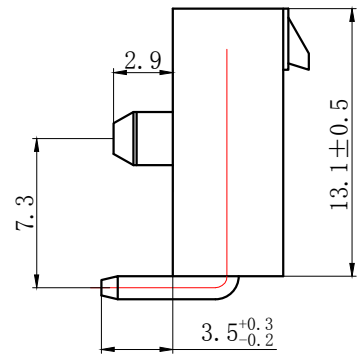
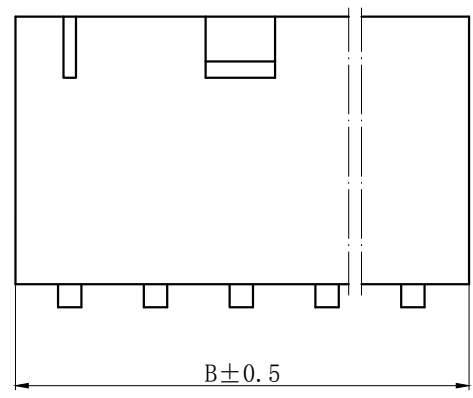

2PIN

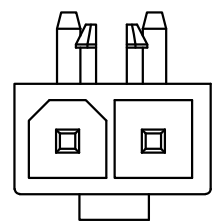

3PIN以上

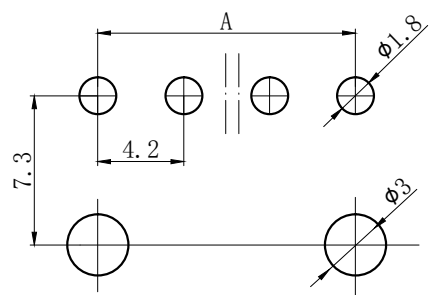

PCB LAYOUT

2PIN

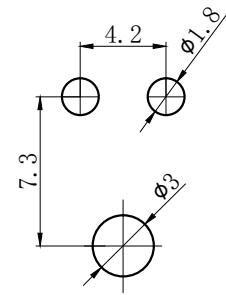

Circuits	Product name	Dimension mm	
		A	B
2	5569-2AWSM	4.20	9.60
3	5569-3AWSM	8.40	13.80
4	5569-4AWSM	12.60	18.00
5	5569-5AWSM	16.80	22.20
6	5569-6AWSM	21.00	26.40
7	5569-7AWSM	25.20	30.60
8	5569-8AWSM	29.40	34.80
9	5569-9AWSM	33.60	39.00
10	5569-10AWSM	37.80	43.20
11	5569-11AWSM	42.00	47.40
12	5569-12AWSM	46.20	51.60

GENERAL TOLERANCES (UNLESS SPECIFIED)		ZHE JIANG DELI CONNECTORS CO., LTD	
.X: ± 0.25	X°: ± 3.0°	PRODUCT NAME:	TITLE: 4.20 mm Pitch Wire To Board Wafer
.XX: ± 0.15	.X°: ± 2.0°	DL42007 (5569)-AWSM	
.XXX: ± 0.01	.XX°: ± 1.0°	DR: Chen Quan Long	DATE:20/10/10
FINISH:		CHKD: Wu Hui	DATE:20/10/10
DRAWING NO:		APPD: Ren An De	DATE:20/10/10
		SCALE: N/A	PAGE: 1/1
		UNITS: mm	REV.: A

REV.	REVISION DESCRIPTION	DATE	APPD

NOTES

Available in 02 through 12 Circuits.

Mates with DL42007 Series Housing.

Material : Nylon UL94V-0(2).

Accepts DL42002-T Crimp Terminal.

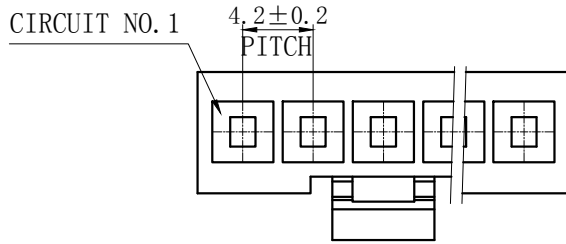
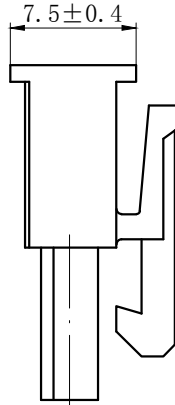
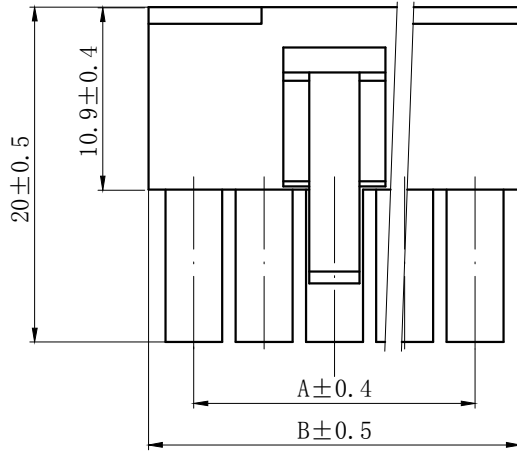
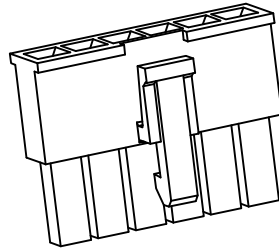
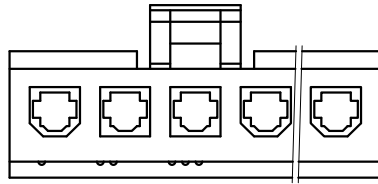

Circuits	Product name	Dimension mm	
		A	B
2	5557-2YM	4.20	9.60
3	5557-3YM	8.40	13.80
4	5557-4YM	12.60	18.00
5	5557-5YM	16.80	22.20
6	5557-6YM	21.00	26.40
7	5557-7YM	25.20	30.60
8	5557-8YM	29.40	34.80
9	5557-9YM	33.60	39.00
10	5557-10YM	37.80	43.20
11	5557-11YM	42.00	47.40
12	5557-12YM	46.20	51.60

GENERAL TOLERANCES (UNLESS SPECIFIED)		ZHE JIANG DELI CONNECTORS CO., LTD	
.X: ± 0.25	X° : ± 3.0°	PRODUCT NAME:	TITLE:
.XX: ± 0.15	.X° : ± 2.0°	DL42008 (5557)-YM	4.20 mm Pitch Housing
.XXX: ± 0.01	.XX° : ± 1.0°	DR: Chen Quan Long	DATE:20/10/10
FINISH:		CHKD: Wu Hui	DATE:20/10/10
DRAWING NO:		APPD: Ren An De	DATE:20/10/10
			PART NO:
			SCALE: N/A
			PAGE: 1/1
			UNITS: mm
			REV.: A

REV.	REVISION DESCRIPTION	DATE	APPD
△	3.2改2.6	2010.10.26	LIU BING
△	2.6改2.9	2016.6.27	Wuhui

NOTES

Used in DL42002-Y Series Housing.

Accepts AWG #28~14 Wire Range.

Insulation O.D.=0.9~3.1mm.

Material : Phosphor Bronze .

Finish: Tin plated.

Thickness: 0.2 mm.

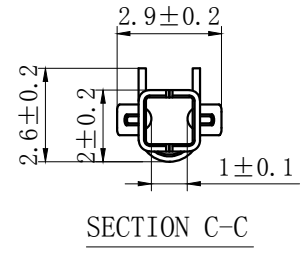
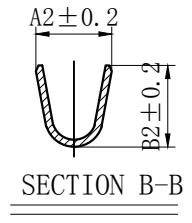
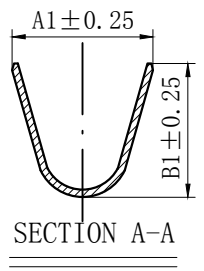
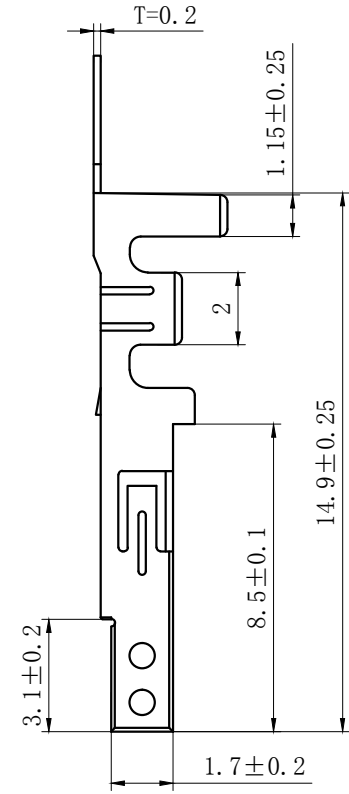
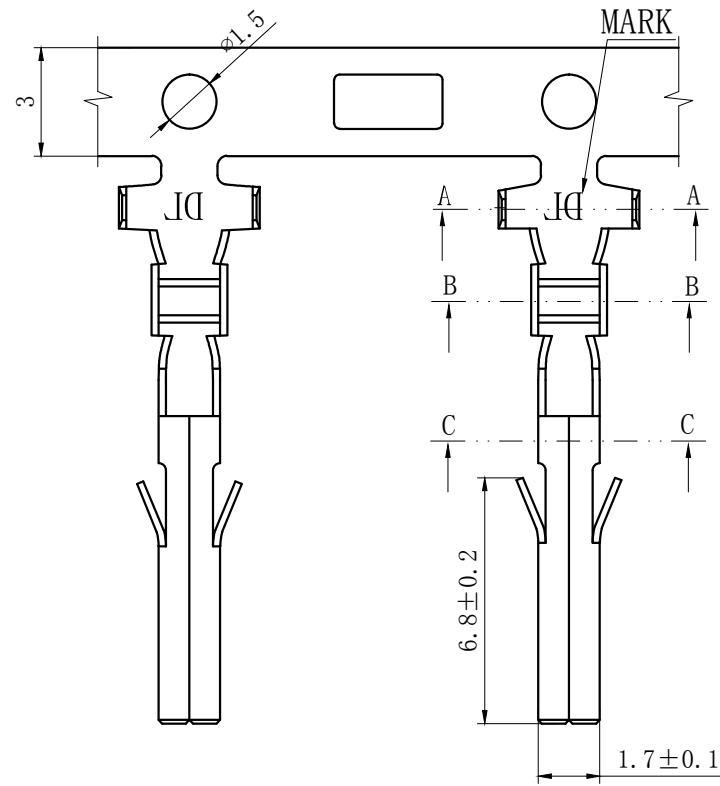

TYPE	Dimension mm				适用线规 AWG#
	A1	B1	A2	B2	
5556-T-04	4.1	4.4	3.1	3.5	14-18
5556-T-03	3.9	4.4	2.1	2.7	16-20
5556-T-02	2.0	2.5	1.5	1.5	24-28

GENERAL TOLERANCES (UNLESS SPECIFIED)		ZHE JIANG DELI CONNECTORS CO., LTD			
.X: ± 0.25	X°: ± 3.0°	PRODUCT NAME: DL42002 (5556) -T		TITLE: 4.20 mm Pitch Crimp Terminal	
.XX: ± 0.15	.X°: ± 2.0°	DR: Chen Quan Long		DATE: 2021/9/27	
.XXX: ± 0.01	.XX°: ± 1.0°	FINISH: _____		PART NO:	
DRAWING NO:		CHKD: Wu Hui	DATE: 2021/9/27	SCALE: N/A	PAGE: 2/2
		APPD: Ren An De	DATE: 2021/9/27	UNITS: mm	REV.: A

REV.	REVISION DESCRIPTION	DATE	APPD
△	3.2改2.6	2010.10.26	LIU BING
△	2.6改2.9	2016.6.27	Wuhui

NOTES

Used in DL42002-Y Series Housing.

Accepts AWG #28~14 Wire Range.

Insulation O.D.=0.9~3.1mm.

Material : Phosphor Bronze .

Finish: Tin plated.

Thickness: 0.2 mm.

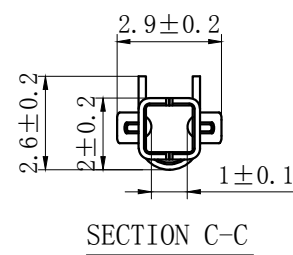
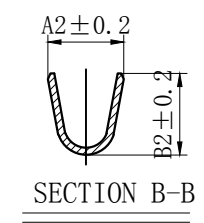
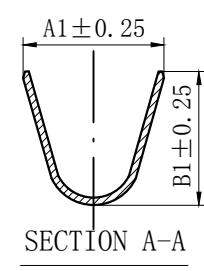
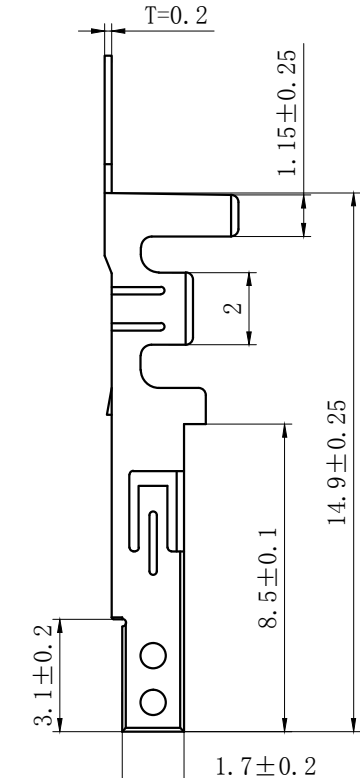
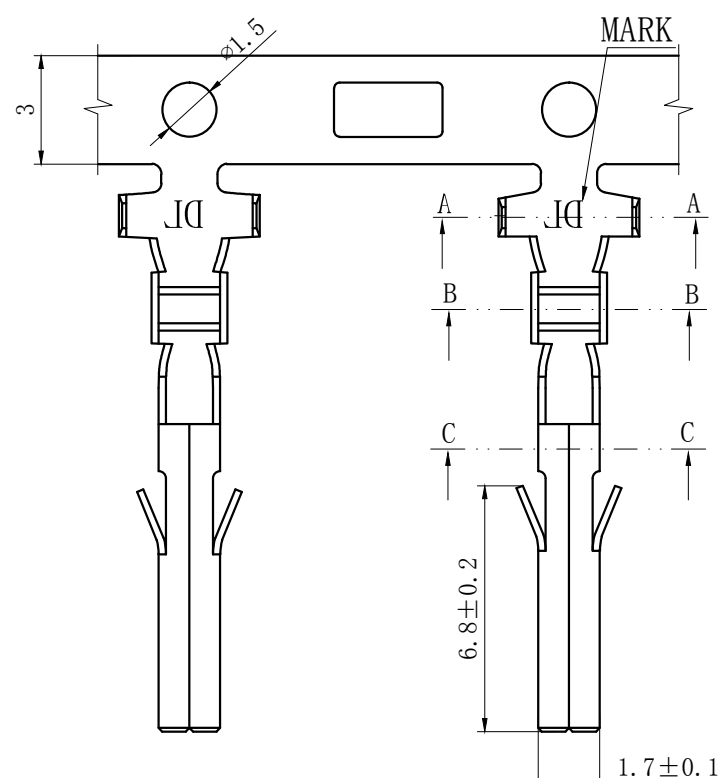

TYPE	Dimension mm				适用线规 AWG#
	A1	B1	A2	B2	
5556-T-04	4.1	4.4	3.1	3.5	14-18
5556-T-03	3.9	4.4	2.1	2.7	16-20
5556-T-02	2.0	2.5	1.5	1.5	24-28

GENERAL TOLERANCES (UNLESS SPECIFIED)		ZHE JIANG DELI CONNECTORS CO., LTD			
.X: ± 0.25	X°: ± 3.0°	PRODUCT NAME: DL42002 (5556)-T		TITLE: 4.20 mm Pitch Crimp Terminal	
.XX: ± 0.15	.X°: ± 2.0°	DR: Chen Quan Long		DATE: 2021/9/27	
.XXX: ± 0.01	.XX°: ± 1.0°	CHKD: Wu Hui		DATE: 2021/9/27	
FINISH:		APPD: Ren An De		DATE: 2021/9/27	
DRAWING NO:		SCALE: N/A		PAGE: 2/2	
		UNITS: mm		REV.: A	

X-ON Electronics

Largest Supplier of Electrical and Electronic Components

Click to view similar products for [Headers & Wire Housings](#) category:

Click to view products by [DLL](#) manufacturer:

Other Similar products are found below :

[0015917161](#) [0022155065](#) [57102-F02-18ULF](#) [58102-G61-06LF](#) [582553-1](#) [01.001.5753.1](#) [0050291907](#) [02.125.8002.8](#) [609-3404](#) [61062-3](#)
[CSU011177004](#) [622-0430](#) [622-3653LF](#) [63453-116](#) [636-1030](#) [636-1427](#) [636-3427](#) [636-4007](#) [641938-9](#) [65495-038](#) [65692-001LF](#) [65781-018](#)
[65781-047](#) [65817-010LF](#) [65817-015LF](#) [67095-007LF](#) [67601157](#) [68631-112](#) [68645-018](#) [699319-000](#) [70.362.1628.0](#) [70-4210](#) [70-4226B](#) [70-](#)
[4853B](#) [71.350.2428.0](#) [733-134](#) [733-162](#) [MHR-64-VUAL](#) [80.063.4001.1](#) [800-90-001-10-001000](#) [801-43-002-10-013000](#) [801-43-006-10-](#)
[002000](#) [803-43-024-10-001000](#) [803-93-012-10-001000](#) [8-1437020-4](#) [819-22-004-30-001101](#) [820-22-006-30-001101](#) [820-22-008-30-001101](#)
[821-22-002-10-001101](#) [821-22-003-10-002101](#)