

技术特性/Specifications:

额定电压 Rated voltage: 125V AC, DC
额定电流 Rated current: 1A AC, DC
接触电阻 Contact resistance: 20m Ω max
绝缘电阻 Insulation resistance: 100M Ω min
耐压 Withstand voltage: 500V AC/minute
环境温度 Ambient temperature: -40 $^{\circ}$ C~+105 $^{\circ}$ C
适用线规 Wire range: AWG#32~#28

REV.	REVISION DESCRIPTION	DATE	APPD
B.	焊片材质磷青铜改为黄铜	2024.1.17	Wu Hui

NOTES

Available in 02 through 20 Circuits.
 Mates with DL12508-Y Series Housing.
 Material : LCP UL94V-0.
 Pin Material : Phosphor bronze.
 Matte-plated .

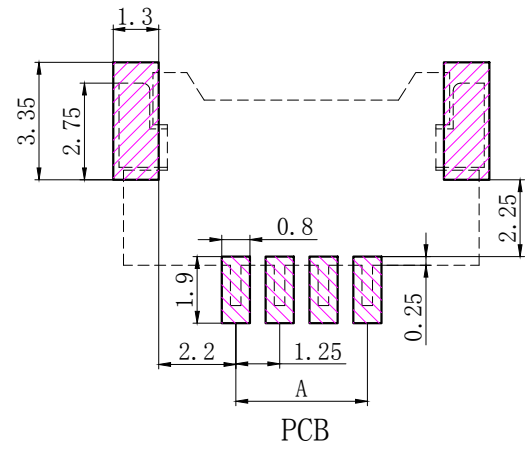
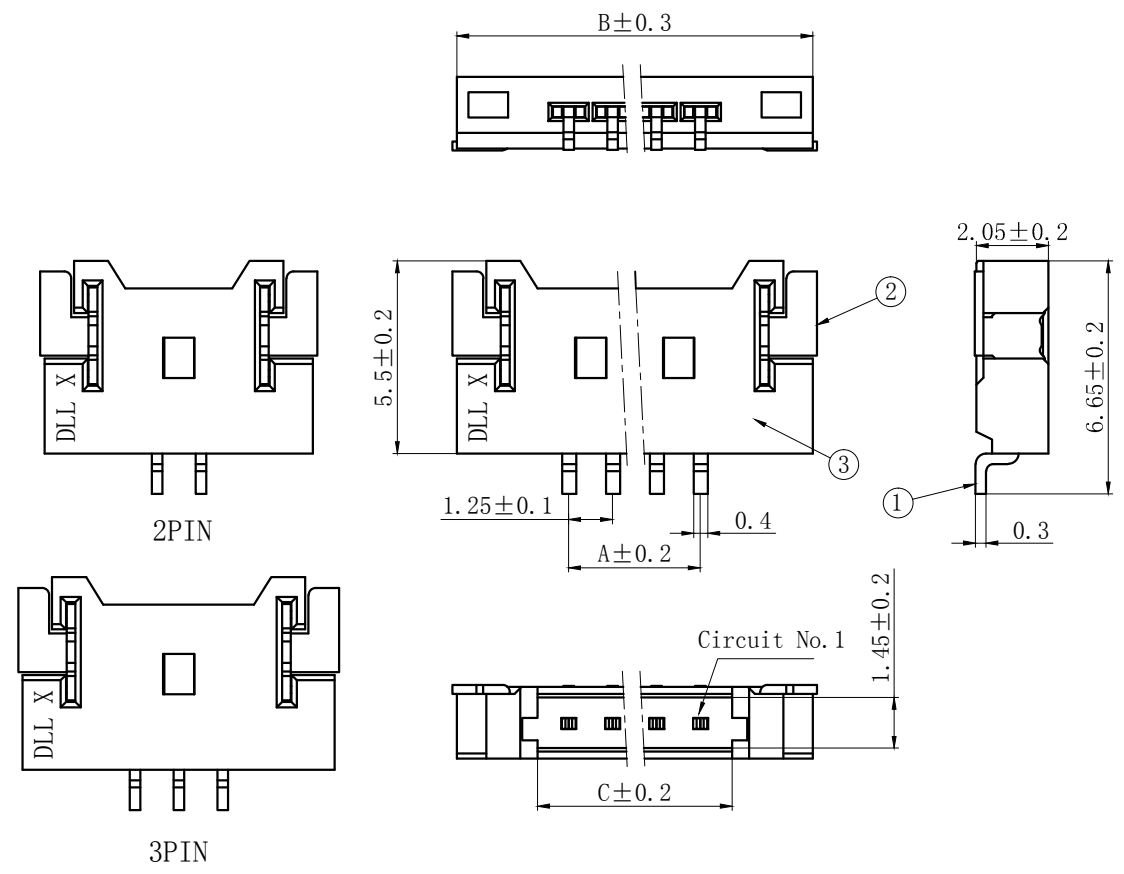

Circuits	Product name	Dimensino (mm)		
		A	B	C
2	DL12508-2AWB	1.25	7.65	3.05
3	DL12508-3AWB	2.50	8.90	4.30
4	DL12508-4AWB	3.75	10.15	5.55
5	DL12508-5AWB	5.00	11.40	6.80
6	DL12508-6AWB	6.25	12.65	8.05
7	DL12508-7AWB	7.50	13.90	9.30
8	DL12508-8AWB	8.75	15.15	10.55
9	DL12508-9AWB	10.00	16.40	11.80
10	DL12508-10AWB	11.25	17.65	13.05
11	DL12508-11AWB	12.50	18.90	14.30
12	DL12508-12AWB	13.75	20.15	15.55
13	DL12508-13AWB	15.00	21.40	16.80
~	~	~	~	~
20	DL12508-20AWB	23.75	30.15	25.55

3	③	基座	LCP	1	UL94V-0
2	②	焊片	黄铜	2	镀亚光
1	①	接触件	磷青铜	N*	镀亚光
序号	图号	名称	材料	数量	附件

GENERAL TOLERANCES (UNLESS SPECIFIED)		ZHE JIANG DELI CONNECTORS CO., LTD			
.X: ± 0.25	X° : ± 3.0°	PRODUCT NAME: DL12508-AWB		TITLE: 1.25 mm Pitch Wire To Board Wafer	
.XX: ± 0.15	.X° : ± 2.0°	DR:Chen Quan Long		DATE:21/04/03	
.XXX: ± 0.01	.XX° : ± 1.0°	DATE:21/04/03		PART NO:	
FINISH: _____		CHKD: Wu Hui	DATE:21/04/03	SCALE: N/A	
DRAWING NO:		APPD:Ren An De	DATE:21/04/03	UNITS: mm	PAGE: 1/1
				REV.: B	

REV.	REVISION DESCRIPTION	DATE	APPD
B	优化加宽隔栅	23.8.4	WH

NOTES

Available in 02 through 20 Circuits.

Material : Nylon UL94V-0(2).

Accepts DL12508-T Crimp Terminal.

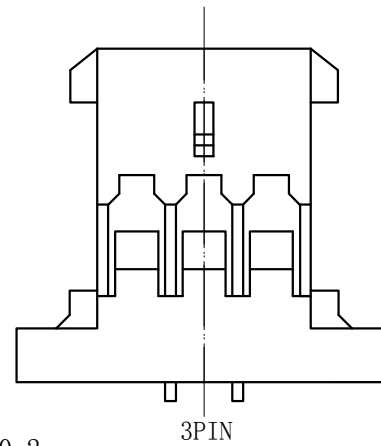
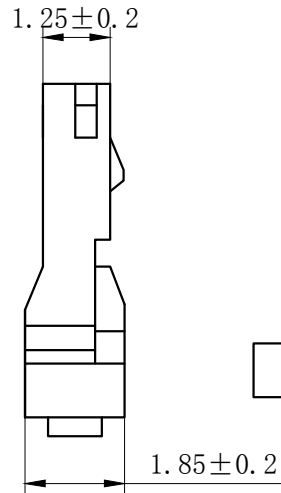
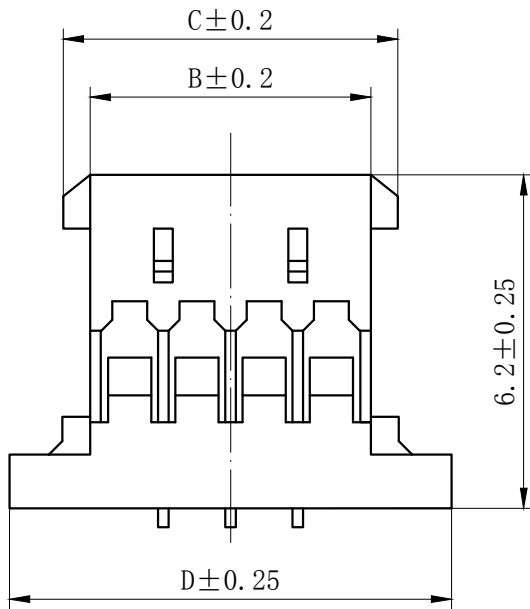
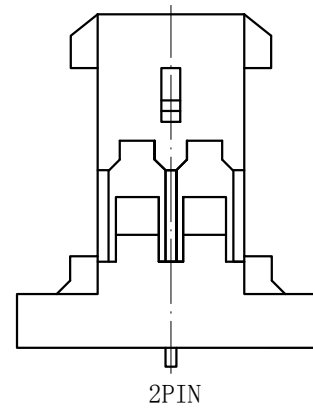
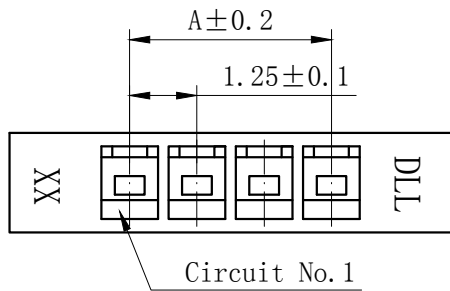

Circuits	Product name	Dimension mm				Circuits	Product name	Dimension mm			
		A	B	C	D			A	B	C	D
2	DL12508-2Y	1.25	2.72	3.72	5.72	10	DL12508-10Y	11.25	12.72	13.72	15.72
3	DL12508-3Y	2.50	3.97	4.97	6.97	11	DL12508-11Y	12.50	13.97	14.97	16.97
4	DL12508-4Y	3.75	5.22	6.22	8.22	12	DL12508-12Y	13.75	15.22	16.22	18.22
5	DL12508-5Y	5.00	6.47	7.47	9.47	13	DL12508-13Y	15.00	16.47	17.47	19.47
6	DL12508-6Y	6.25	7.72	8.72	10.72	14	DL12508-14Y	16.25	17.72	18.72	20.72
7	DL12508-7Y	7.50	8.97	9.97	11.97	15	DL12508-15Y	17.50	18.97	19.97	21.97
8	DL12508-8Y	8.75	10.22	11.22	13.22	-	-	-	-	-	-
9	DL12508-9Y	10.00	11.47	12.47	14.47	20	DL12508-20Y	23.75	25.22	26.22	28.22

GENERAL TOLERANCES (UNLESS SPECIFIED)		ZHE JIANG DELI CONNECTORS CO., LTD	
.X: ± 0.25	X°: ± 3.0°	PRODUCT NAME: DL12508-Y	TITLE: 1.25 mm Pitch W To B Housing
.XX: ± 0.15	.X°: ± 2.0°	DR: Chen Quan Long	DATE: 21/01/25
.XXX: ± 0.01	.XX°: ± 1.0°	DATE: 21/01/25	PART NO:
FINISH:		CHKD: Wu Hui	SCALE: N/A
DRAWING NO:		APPD: Ren An De	PAGE: 1/1
		DATE: 21/01/25	UNITS: mm
			REV.: B

REV.	REVISION DESCRIPTION	DATE	APPD

NOTES

Used in DL12508-Y Series Housing.
 Accepts AWG #32~#28 Wire Range.
 Insulation O.D.=0.5~1.0 mm.
 Material : Phosphor Bronze .
 Finish: Tin plated.
 Thickness: 0.15mm.

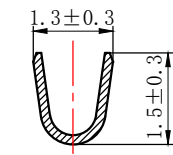
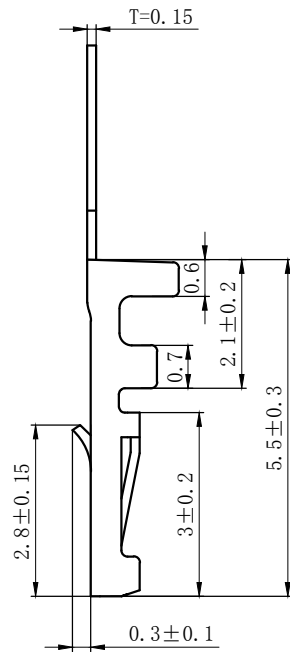
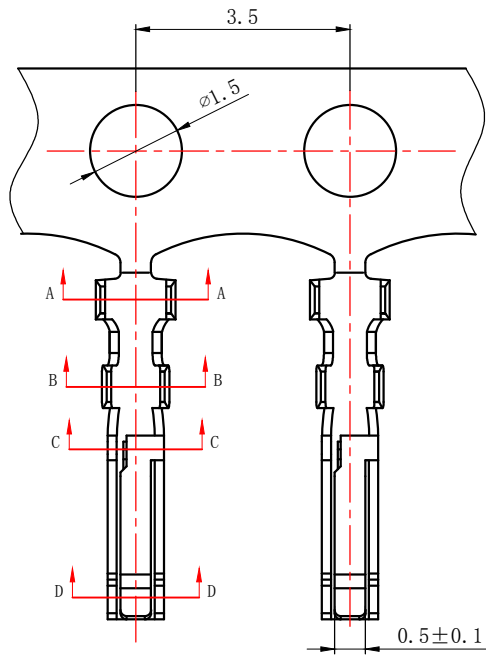
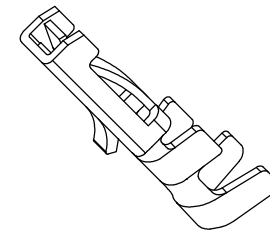

SECTION A-A

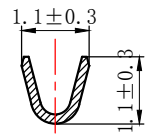

SECTION B-B

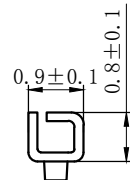

SECTION C-C

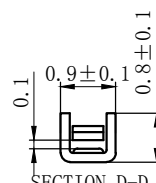

SECTION D-D

GENERAL TOLERANCES (UNLESS SPECIFIED)		ZHE JIANG DELI CONNECTORS CO., LTD	
.X: ± 0.25	X° : ± 3.0°	PRODUCT NAME: DL12508-T	TITLE: 1.25mm Pitch Wire To Board Crimp Terminal
.XX: ± 0.15	.X° : ± 2.0°	DR: Yuan Jun Rong	DATE:21.10.7
.XXX: ± 0.01	.XX° : ± 1.0°	CHKD: Wu Hui	DATE:21.10.7
FINISH:		APPD: Ren An De	DATE:21.10.7
DRAWING NO:		UNITS: mm	PART NO: SCALE: N/A PAGE: 1/1 REV. : A

X-ON Electronics

Largest Supplier of Electrical and Electronic Components

Click to view similar products for [Headers & Wire Housings](#) category:

Click to view products by [DLL](#) manufacturer:

Other Similar products are found below :

[0015917161](#) [0022155065](#) [57102-F02-18ULF](#) [58102-G61-06LF](#) [582553-1](#) [01.001.5753.1](#) [0050291907](#) [02.125.8002.8](#) [609-3404](#) [61062-3](#)
[CSU011177004](#) [622-0430](#) [622-3653LF](#) [63453-116](#) [636-1030](#) [636-1427](#) [636-3427](#) [636-4007](#) [641938-9](#) [65495-038](#) [65692-001LF](#) [65781-018](#)
[65781-047](#) [65817-010LF](#) [65817-015LF](#) [67095-007LF](#) [67601157](#) [68631-112](#) [68645-018](#) [699319-000](#) [70.362.1628.0](#) [70-4210](#) [70-4226B](#) [70-](#)
[4853B](#) [71.350.2428.0](#) [733-134](#) [733-162](#) [MHR-64-VUAL](#) [80.063.4001.1](#) [800-90-001-10-001000](#) [801-43-002-10-013000](#) [801-43-006-10-](#)
[002000](#) [803-43-024-10-001000](#) [803-93-012-10-001000](#) [8-1437020-4](#) [819-22-004-30-001101](#) [820-22-006-30-001101](#) [820-22-008-30-001101](#)
[821-22-002-10-001101](#) [821-22-003-10-002101](#)