

## 技术特性/Specifications:

额定电压 Rated voltage: 100V AC, DC  
额定电流 Rated current: 3A AC, DC  
接触电阻 Contact resistance: 20m $\Omega$  max  
绝缘电阻 Insulation resistance: 1000M $\Omega$  min  
耐压 Withstand voltage: 1000V AC/minute  
环境温度 Ambient temperature: -40 $^{\circ}$ C~+105 $^{\circ}$ C  
适用线规 Wire range: AWG#26~#22

REV.	REVISION DESCRIPTION	DATE	APPD
B	外形尺寸作调整	22.7.4	Wuhui

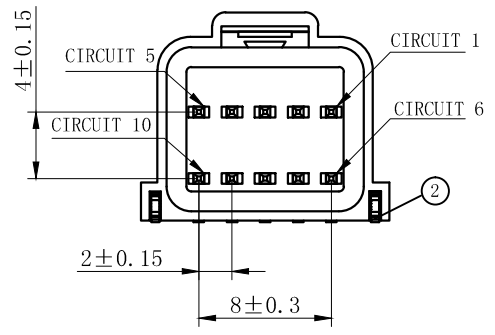

**NOTES**

Available in 10 Circuits.  
 Mates with DL20023-Y Series Housing.  
 Material : LCP UL94V-0.  
 Pin Material : Brass.Tin-plated .  
 Green Material RoHS Compliant.

序号	图号	名称	材料	数量	附件
3	③	基座	LCP	1	UL94V-0
2	②	焊片	黄铜	2	镀锡
1	①	接触件	黄铜	N*	镀锡

GENERAL TOLERANCES (UNLESS SPECIFIED)		ZHE JIANG DELI CONNECTORS CO ., LTD	
.X: ± 0.30	X° : ± 3.0°	PRODUCT NAME: DL20023-10AWB	
.XX: ± 0.15	.X° : ± 2.0°	TITLE: 2.00 mm Pitch Wire To Board SMT Wafer	
.XXX: ± 0.01	.XX° : ± 1.0°	DR:Chen Quan Long	DATE:22.05.19
FINISH: _____		CHKD: Wu Hui	DATE:22.05.19
DRAWING NO: GC-DL20023-XXWB-XXX-XX-X-XX		APPD: Ren An De	DATE:22.05.19
		SCALE: N/A	PAGE:1/1
		UNITS: mm	REV. : B

REV.	REVISION DESCRIPTION	DATE	APPD

### DL20023-2AS

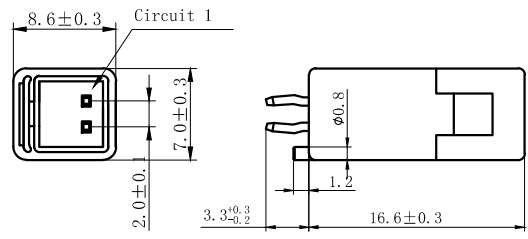

### DL20023-6AS

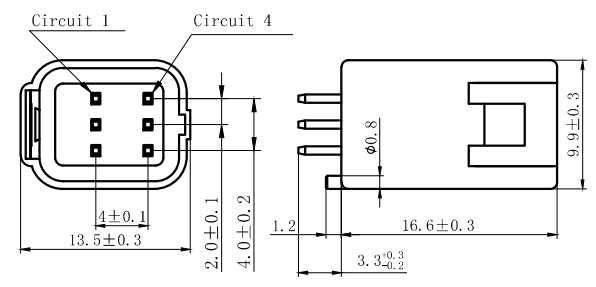

### DL20023-3AS

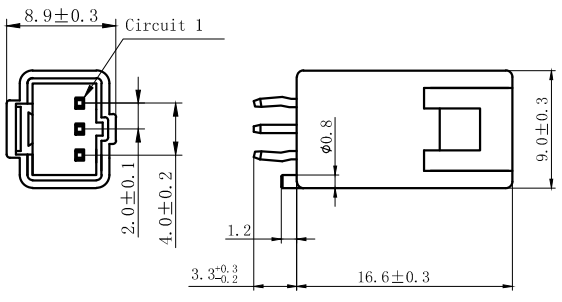

### DL20023-8AS

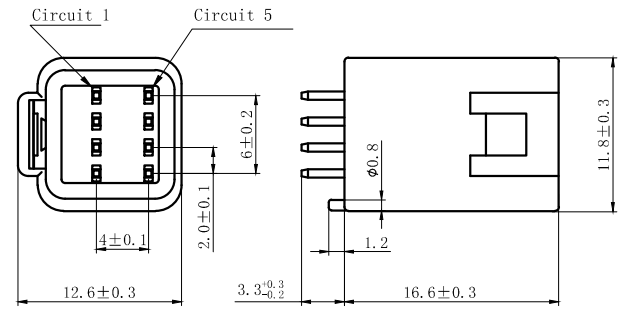

### DL20023-4AS

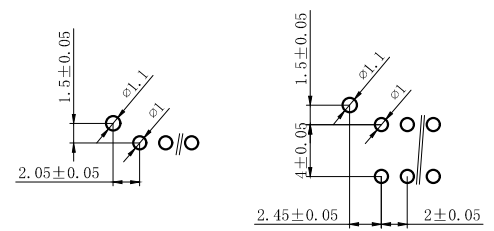
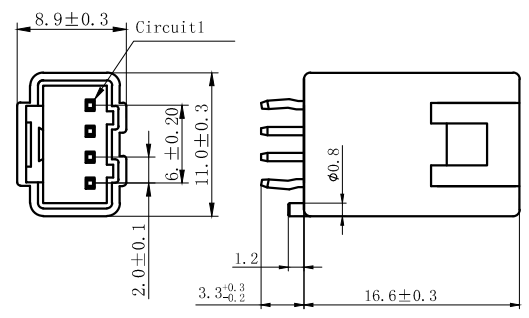

P. C. B LATOUT

NORES:

1. Rated voltage: 100V AC/DC
2. Rated current: 3A AC/DC
3. Contact resistance:  $\leq 15 \text{ m}\Omega$
4. Insulation resistance:  $\geq 1000 \text{ M}\Omega$
5. Withstand voltage: 1000V AC/minute
6. Ambient temperature:  $-40^\circ\text{C} \sim 105^\circ\text{C}$
7. Materials: PBT UL94V-0(2).
8. Matched RoHS criteria

GENERAL TOLERANCES (UNLESS SPECIFIED)		ZHE JIANG DELI CONNECTORS CO., LTD	
.X: $\pm 0.30$	X°: $\pm 3.0^\circ$	PRODUCT NAME: DL20023-AS	TITLE: 2.0 mm Pitch Wire To Board Wafer
.XX: $\pm 0.15$	.X°: $\pm 2.0^\circ$	DR: Yuan Jun Rong	DATE: 20.10.12
.XXX: $\pm 0.01$	.XX°: $\pm 1.0^\circ$	CHKD: Wu Hui	DATE: 20.10.12
DRAWING NO:		APPD: Ren An De	DATE: 20.10.12
FINISH:		SCALE: N/A	PAGE: 1/2
		UNITS: mm	REV.: A

REV.	REVISION DESCRIPTION	DATE	APPD

DL20023-10AS

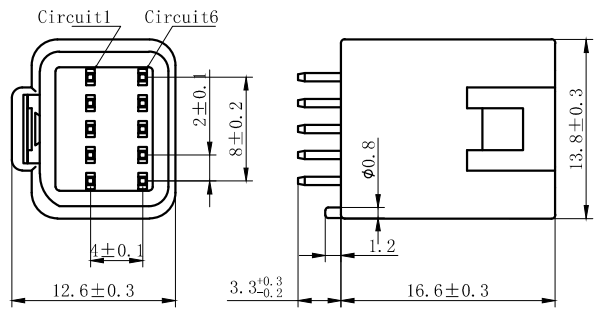

DL20023-12AS

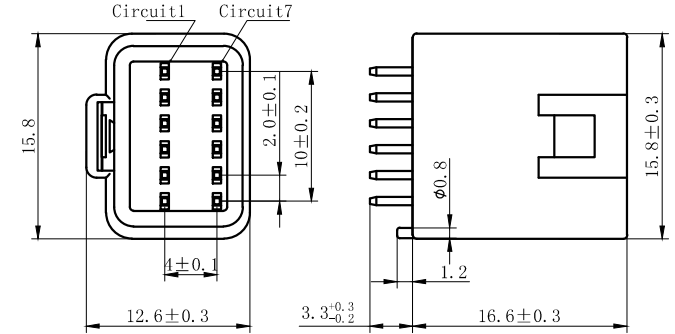

- NORES:
1. Rated voltage: 100V AC/DC
  2. Rated current: 3A AC/DC
  3. Contact resistance: ≤15 mΩ
  4. Insulation resistance: ≥1000MΩ
  5. Withstand voltage: 1000V AC/minute
  6. Ambient temperature: -40°C~105°C
  7. Materials: PBT UL94V-0(2).
  8. Matched RoHS criteria

DL20023-14AS

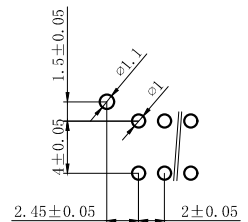
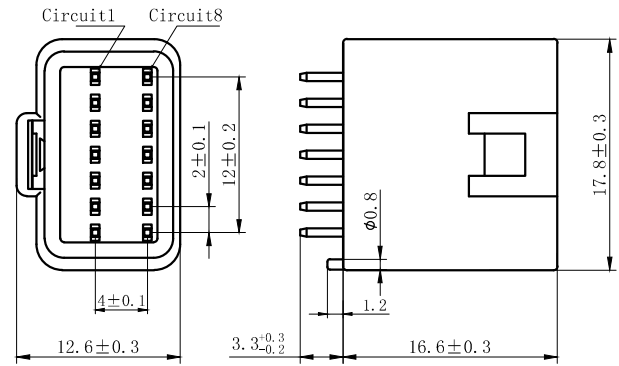

P. C. B LATOUT

GENERAL TOLERANCES (UNLESS SPECIFIED)		ZHE JIANG DELI CONNECTORS CO., LTD	
.X: ± 0.30	X°: ± 3.0°	PRODUCT NAME:	TITLE: 2.0 mm Pitch Wire To Board Wafer
.XX: ± 0.15	.X°: ± 2.0°	DL20023-AS	
.XXX: ± 0.01	.XX°: ± 1.0°	DR: Yuan Jun Rong	DATE: 20.10.12
FINISH:		CHKD: Wu Hui	DATE: 20.10.12
DRAWING NO:		APPD: Ren An De	DATE: 20.10.12
			PART NO:
			SCALE: N/A
			PAGE: 2/2
			UNITS: mm
			REV.: A

REV.	REVISION DESCRIPTION	DATE	APPD

### DL20023-2AWS

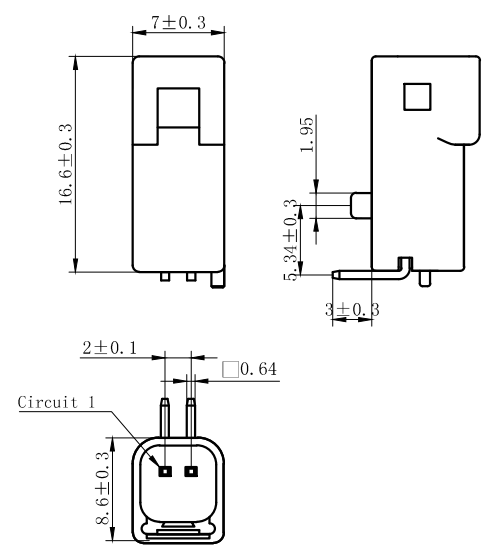

### DL20023-3AWS

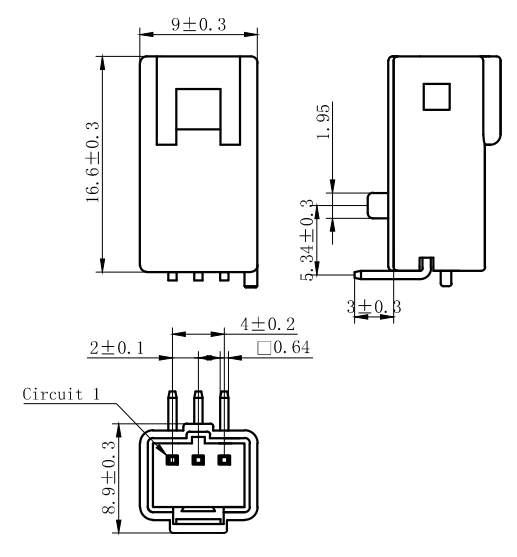

- NORES:
1. Rated voltage: 100V AC.DC
  2. Rated current: 3A AC DC
  3. Contact resistance:  $\leq 15 \text{ m}\Omega$
  4. Insulation resistance:  $\geq 1000 \text{ M}\Omega$
  5. Withstand voltage: 1000V AC/minute
  6. Ambient temprature:  $-40^\circ\text{C} \sim 105^\circ\text{C}$
  7. Materials: PBT UL94V-0(2).
  8. Matched RoHS criteria

### DL20023-4AWS

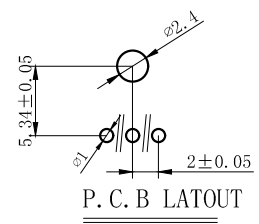
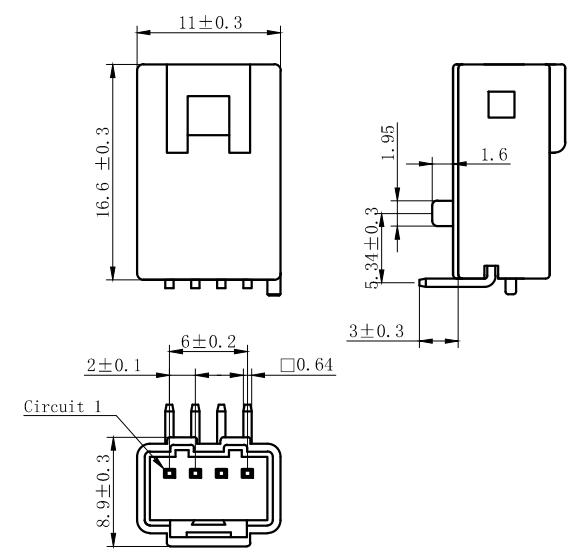

GENERAL TOLERANCES (UNLESS SPECIFIED)		ZHE JIANG DELI CONNECTORS CO., LTD			
.X: $\pm 0.30$	X°: $\pm 3.0^\circ$	PRODUCT NAME: DL20023-AWS		TITLE: 2.0 mm Pitch Wire To Board Wafer	
.XX: $\pm 0.15$	.X°: $\pm 2.0^\circ$	DR: Yuan Jun Rong	DATE: 20.10.12	PART NO:	
.XXX: $\pm 0.01$	.XX°: $\pm 1.0^\circ$	CHKD: Wu Hui	DATE: 20.10.12	SCALE: N/A	PAGE: 1/3
DRAWING NO:		APPD: Ren An De	DATE: 20.10.12	UNITS: mm	REV.: A

### DL20023-6AWS

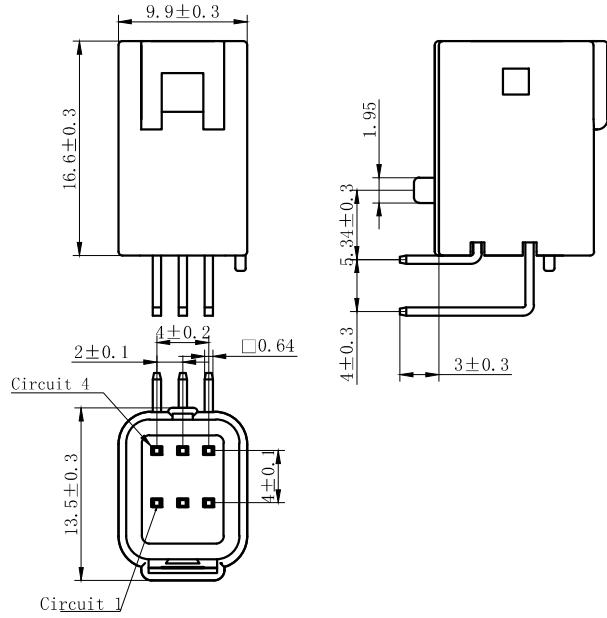

### DL20023-8AWS

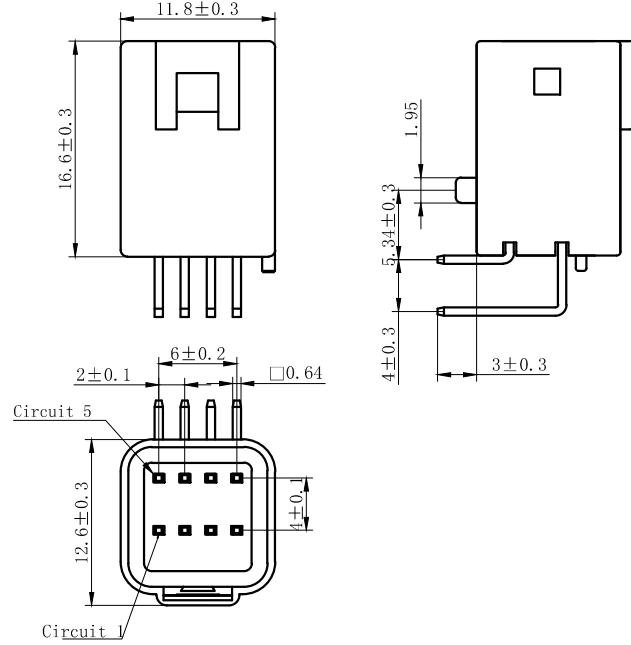

### DL20023-10AWS

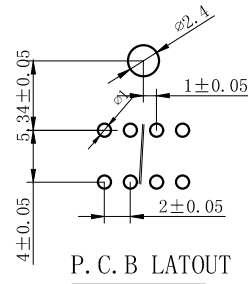
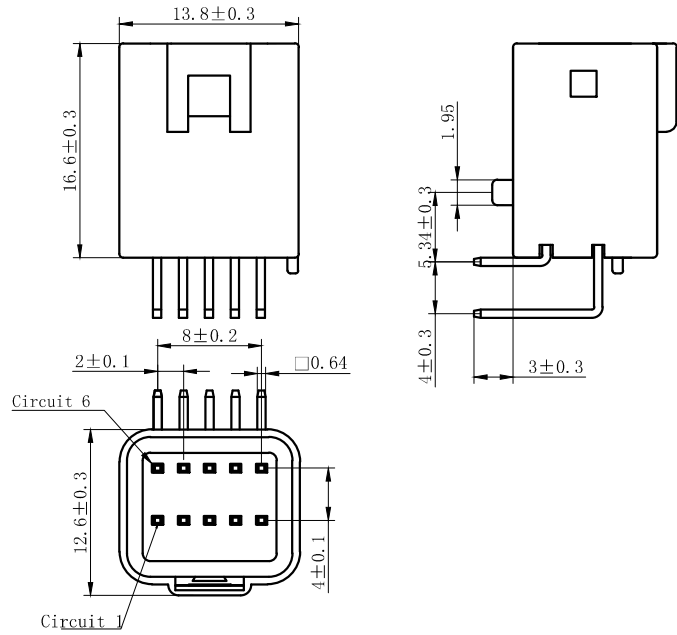

#### NORES:

1. Rated voltage: 100V AC/DC
2. Rated current: 3A AC/DC
3. Contact resistance:  $\leq 15 \text{ m}\Omega$
4. Insulation resistance:  $\geq 1000 \text{ M}\Omega$
5. Withstand voltage: 1000V AC/minute
6. Ambient temperature:  $-40^\circ\text{C} \sim 105^\circ\text{C}$
7. Materials: PBT UL94V-0(2).
8. Matched RoHS criteria

GENERAL TOLERANCES (UNLESS SPECIFIED)		ZHE JIANG DELI CONNECTORS CO., LTD			
.X: $\pm 0.30$	X°: $\pm 3.0^\circ$	PRODUCT NAME: DL20023-AWS		TITLE: 2.0 mm Pitch Wire To Board Wafer	
.XX: $\pm 0.15$	.X°: $\pm 2.0^\circ$	DR: Yuan Jun Rong	DATE: 20.10.12	PART NO:	
.XXX: $\pm 0.01$	.XX°: $\pm 1.0^\circ$	FINISH:	CHKD: Wu Hui	DATE: 20.10.12	SCALE: N/A
DRAWING NO:		APPD: Ren An De	DATE: 20.10.12	UNITS: mm	PAGE: 2/3
				REV.: A	

REV.	REVISION DESCRIPTION	DATE	APPD

### DL20023-12AWS

### DL20023-14AWS

**NORES:**

1. Rated voltage: 100V AC.DC
2. Rated current: 3A AC DC
3. Contact resistance:  $\leq 15 \text{ m}\Omega$
4. Insulation resistance:  $\geq 1000 \text{ M}\Omega$
5. Withstand voltage: 1000V AC/minute
6. Ambient temperature:  $-40^{\circ}\text{C} \sim 105^{\circ}\text{C}$
7. Materials: PBT UL94V-0(2).
8. Matched RoHS criteria

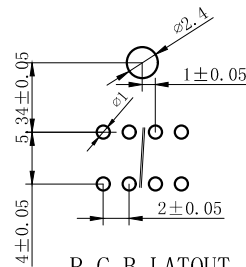
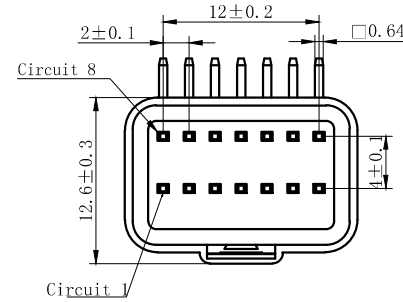
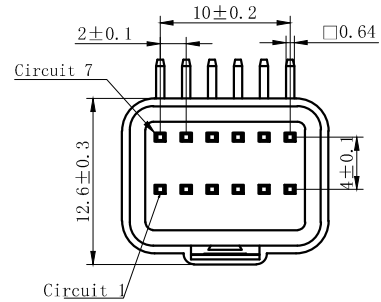
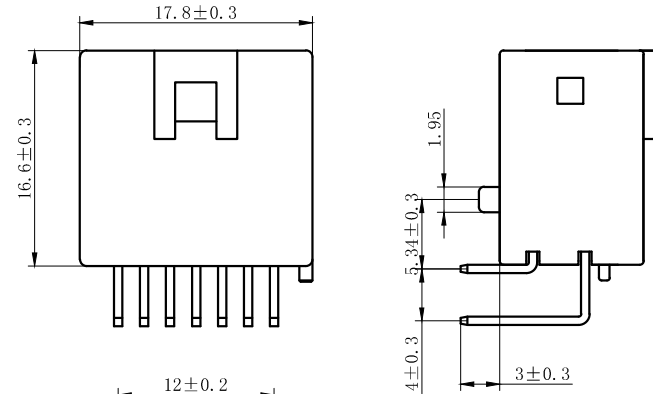
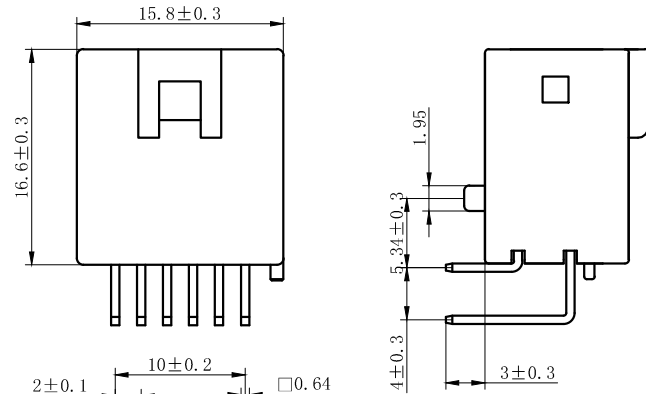

P. C. B LATOUT

GENERAL TOLERANCES (UNLESS SPECIFIED)		ZHE JIANG DELI CONNECTORS CO., LTD	
.X: ± 0.30	X°: ± 3.0°	PRODUCT NAME: DL20023-AWS	TITLE: 2.0 mm Pitch Wire To Board Wafer
.XX: ± 0.15	.X°: ± 2.0°	DR: Yuan Jun Rong	DATE: 20.10.12
.XXX: ± 0.01	.XX°: ± 1.0°	CHKD: Wu Hui	DATE: 20.10.12
DRAWING NO:		APPD: Ren An De	DATE: 20.10.12
		PART NO:	SCALE: N/A
			PAGE: 3/3
		UNITS: mm	REV.: A

DL20023-2Y

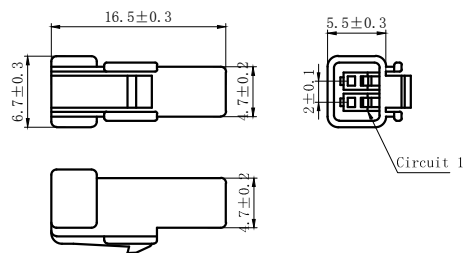

DL20023-3Y

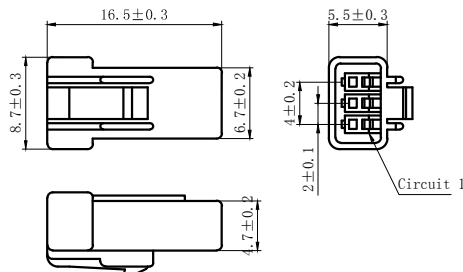

DL20023-8Y

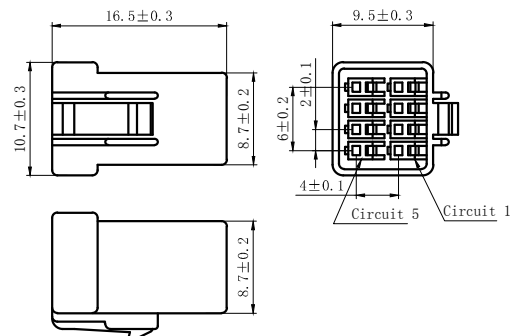

REV.	REVISION DESCRIPTION	DATE	APPD

DL20023-4Y

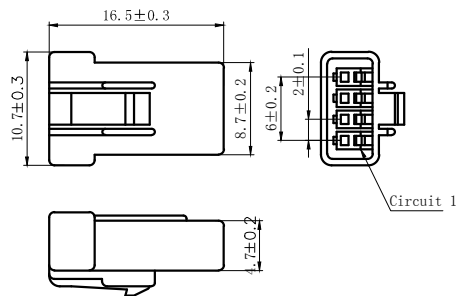

DL20023-6Y

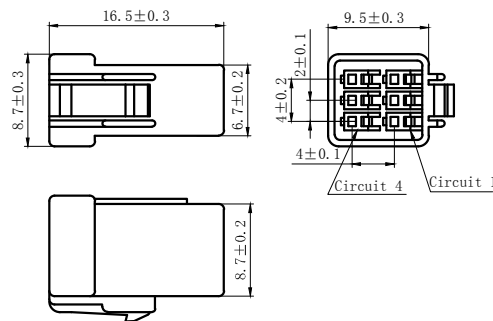

NOTES

Available in 02.03.04.06.08 Circuits.  
 Mates with DL20023 Series Housing.  
 Material : PBT UL94V-0(2).  
 Accepts DL20023-T Crimp Terminal.  
 Green Material RoHS Compliant.

GENERAL TOLERANCES (UNLESS SPECIFIED)		ZHE JIANG DELI CONNECTORS CO.,LTD	
. X: ± 0.30	X° ± 3.0°	PRODUCT NAME:	TITLE:
. XX: ± 0.15	. X° ± 2.0°	DL20023-Y	
. XXX: ± 0.01	. X° ± 1.0°	DR:Chen Quan Long	DATE:21/08/01
FINISH:		CHKD:Wu Hui	DATE:21/08/01
DRAWING NO:		APPD:Ren An De	DATE:21/08/01
		PART NO:	
		2.0 mm Pitch Housing	
		SCALE: N/A	PAGE:1/2
		UNITS: mm	REV.: A



REV.	REVISION DESCRIPTION	DATE	APPD

DL20023-10Y

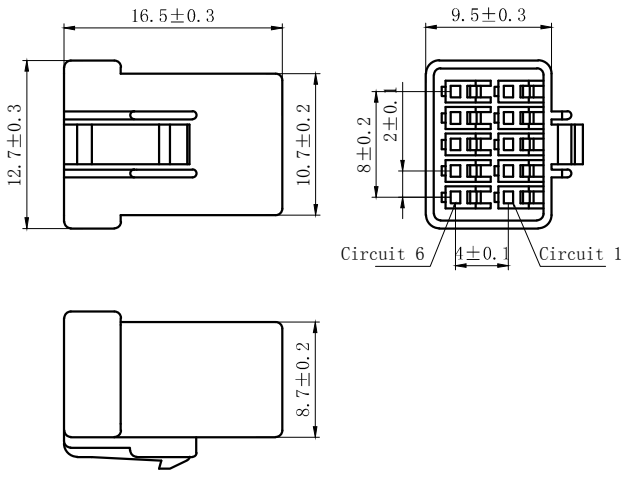

DL20023-12Y

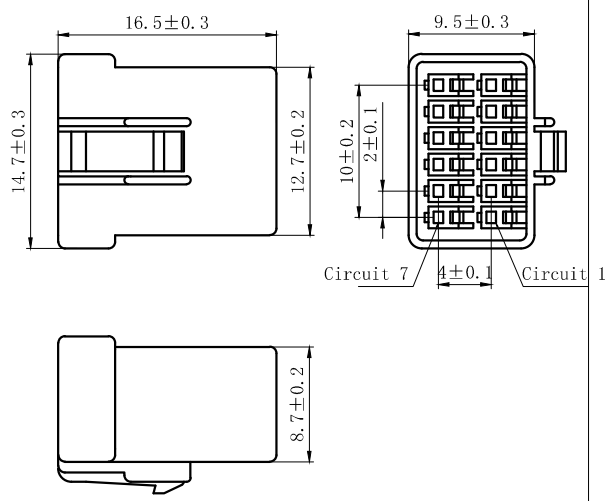

NOTES

Available in 10.12.14 Circuits.  
 Mates with DL20023 Series Housing.  
 Material : PBT UL94V-0(2).  
 Accepts DL20023-T Crimp Terminal.  
 Green Material RoHS Compliant.

DL20023-14Y

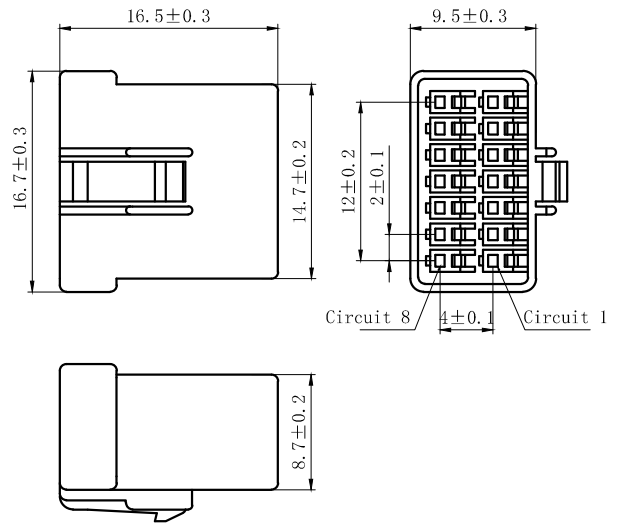

GENERAL TOLERANCES (UNLESS SPECIFIED)		ZHE JIANG DELI CONNECTORS CO., LTD	
.X: ± 0.30	X° ± 3.0°	PRODUCT NAME: DL20023-Y	TITLE: 2.0 mm Pitch Housing
.XX: ± 0.15	.X° ± 2.0°	DR: Chen Quan Long	DATE: 21/08/01
.XXX: ± 0.01	.X° ± 1.0°	CHKD: Wu Hui	DATE: 21/08/01
FINISH:		APPD: Ren An De	DATE: 21/08/01
DRAWING NO:			

A

B

C

D

E

F

A

B

C

D

E

F

1

2

3

4

5

6

7

8

1

2

3

4

5

6

7

8

DL20023-2Y-0.75

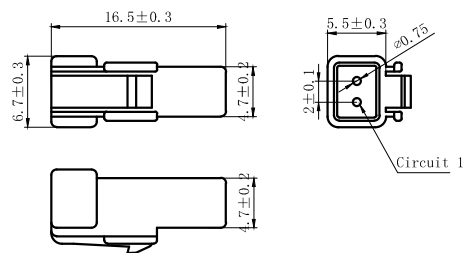

DL20023-3Y-0.75

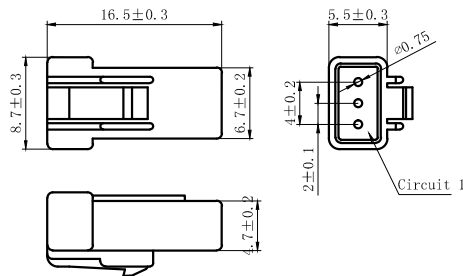

DL20023-8Y-0.75

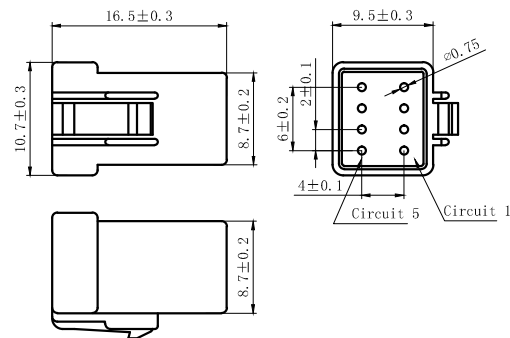

REV.	REVISION DESCRIPTION	DATE	APPD

DL20023-4Y-0.75

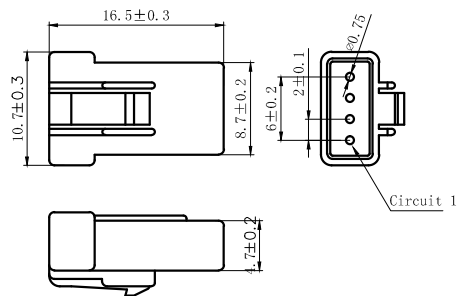

DL20023-6Y-0.75

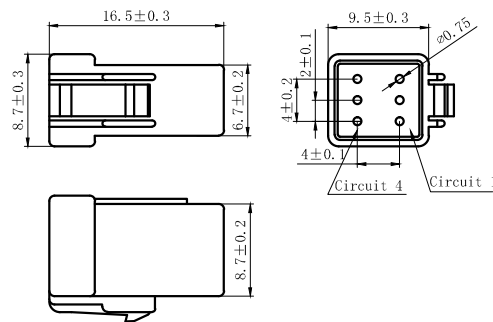

NOTES

Available in 02.03.04.06.08 Circuits.  
 Mates with DL20023 Series Housing.  
 Material : PBT UL94V-0(2).  
 Accepts DL20023-T Crimp Terminal.  
 Green Material RoHS Compliant.

GENERAL TOLERANCES (UNLESS SPECIFIED)		ZHE JIANG DELI CONNECTORS CO.,LTD	
.X: ± 0.30	X° ± 3.0°	PRODUCT NAME: DL20023-Y-0.75	TITLE: 2.0 mm Pitch Housing
.XX: ± 0.15	.X° ± 2.0°	DR:Chen Quan Long	DATE:21/08/01
.XXX: ± 0.01	.X° ± 1.0°	CHKD:Wu Hui	DATE:21/08/01
FINISH:		APPD:Ren An De	DATE:21/08/01
DRAWING NO:			

PART NO:	
SCALE: N/A	PAGE:1/2
UNITS: mm	REV.: A

REV.	REVISION DESCRIPTION	DATE	APPD

DL20023-10R-0.75

DL20023-12R-0.75

DL20023-14R-0.75

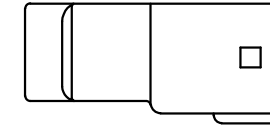
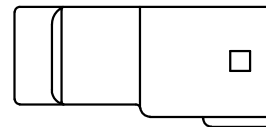
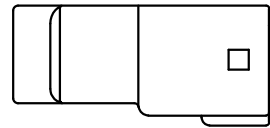
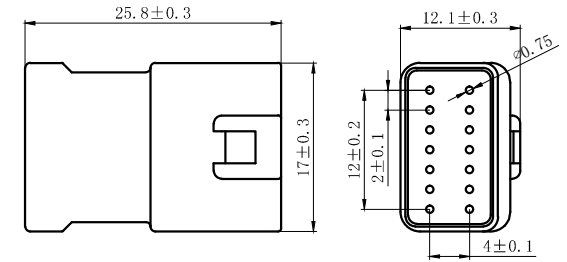
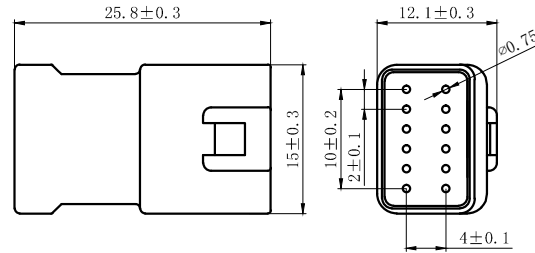
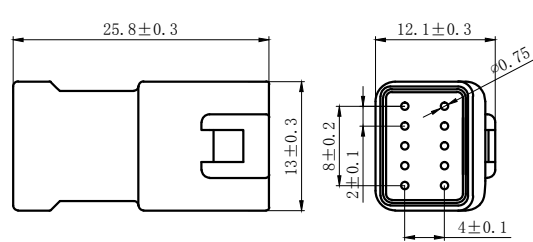

## NOTES

- Available in 10.12.14 Circuits.
- Mates with DL20023-Y Series Housing.
- Material : PBT UL94V-0(2).
- Accepts DL20023-RT Crimp Terminal.
- Green Material RoHS Compliant.

GENERAL TOLERANCES (UNLESS SPECIFIED)		ZHE JIANG DELI CONNECTORS CO., LTD	
.X: ± 0.30	X° : ± 3.0°	PRODUCT NAME: DL20023-R-0.75	TITLE: 2.0 mm Pitch Wire To Wire Receptacle Housing
.XX: ± 0.15	.X° : ± 2.0°	DR:Chen Quan Long	DATE:21/08/01
.XXX: ± 0.01	.XX° : ± 1.0°	CHKD:Wu Hui	DATE:21/08/01
DRAWING NO:		APPD:Ren An De	DATE:21/08/01
FINISH:		SCALE: N/A	PAGE:2/2
		UNITS: mm	REV. : A

REV.	REVISION DESCRIPTION	DATE	APPD

DL20023-2R

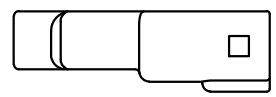
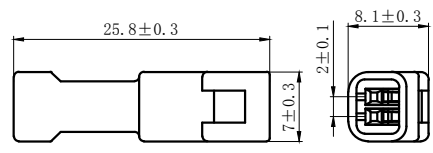

DL20023-3R

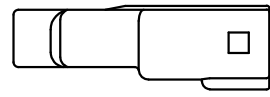
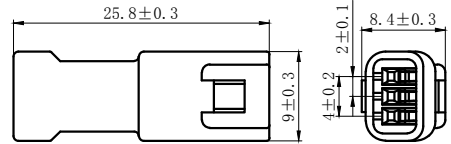

DL20023-8R

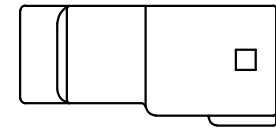
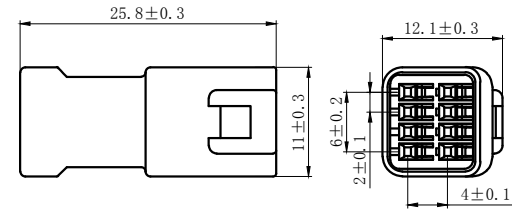

DL20023-4R

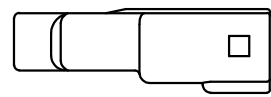
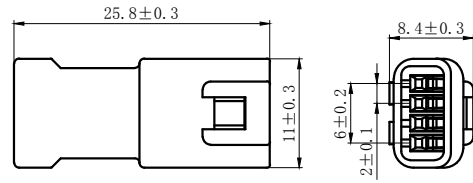

DL20023-6R

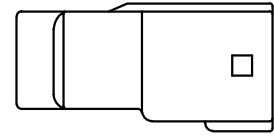
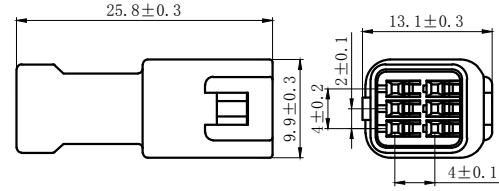

NOTES

Available in 02.03.04.06.08 Circuits.  
 Mates with DL20023-Y Series Housing.  
 Material : PBT UL94V-0(2).  
 Accepts DL20023-RT Crimp Terminal.  
 Green Material RoHS Compliant.

GENERAL TOLERANCES (UNLESS SPECIFIED)		ZHE JIANG DELI CONNECTORS CO., LTD	
.X: ± 0.30	X°: ± 3.0°	PRODUCT NAME: DL20023-R	TITLE: 2.0 mm Pitch Wire To Wire Receptacle Housing
.XX: ± 0.15	.X°: ± 2.0°	DR:Chen Quan Long	DATE:21/08/01
.XXX: ± 0.01	.XX°: ± 1.0°	CHKD:Wu Hui	DATE:21/08/01
FINISH: _____		APPD:Ren An De	DATE:21/08/01
DRAWING NO:		SCALE: N/A	PAGE:1/2
		UNITS: mm	REV.: A

REV.	REVISION DESCRIPTION	DATE	APPD

DL20023-10R

DL20023-12R

DL20023-14R

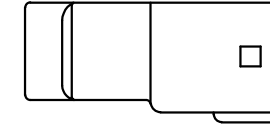
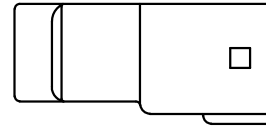
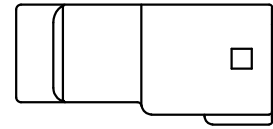
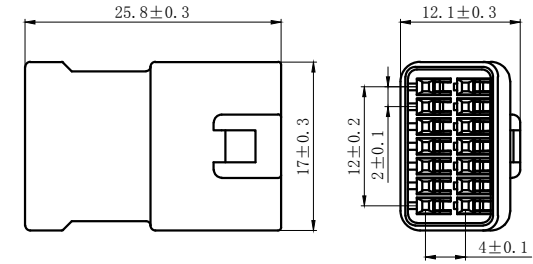
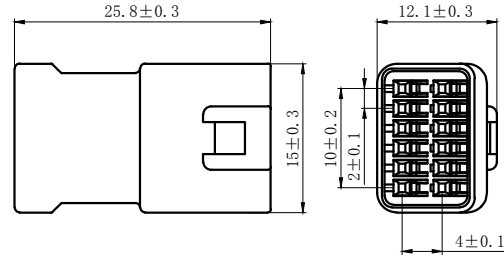
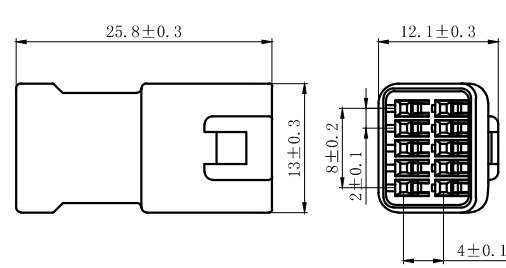

### NOTES

- Available in 10.12.14 Circuits.
- Mates with DL20023-Y Series Housing.
- Material : PBT UL94V-0(2).
- Accepts DL20023-RT Crimp Terminal.
- Green Material RoHS Compliant.

GENERAL TOLERANCES (UNLESS SPECIFIED)		ZHE JIANG DELI CONNECTORS CO., LTD	
.X: ± 0.30	X° : ± 3.0°	PRODUCT NAME: DL20023-R	TITLE: 2.0 mm Pitch Wire To Wire Receptacle Housing
.XX: ± 0.15	.X° : ± 2.0°	DR:Chen Quan Long	DATE:21/08/01
.XXX: ± 0.01	.XX° : ± 1.0°	CHKD:Wu Hui	DATE:21/08/01
FINISH: _____		APPD:Ren An De	DATE:21/08/01
DRAWING NO:		UNITS: mm	REV. : A

REV.	REVISION DESCRIPTION	DATE	APPD

DL20023-2R-0.75

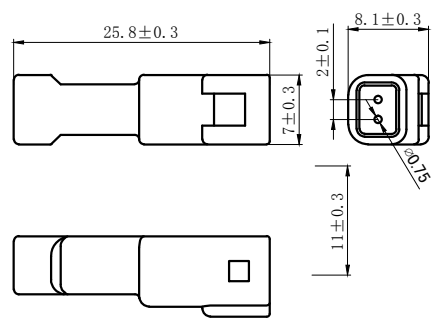

DL20023-3R-0.75

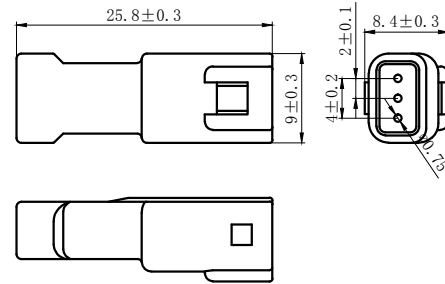

DL20023-8R-0.75

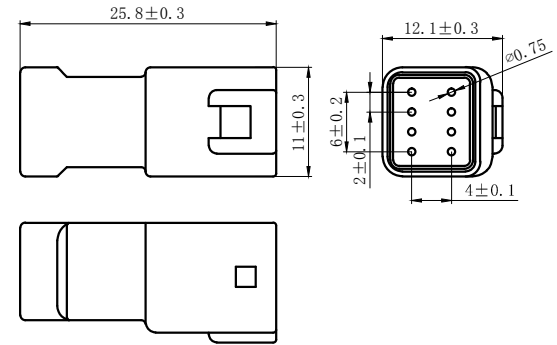

DL20023-4R-0.75

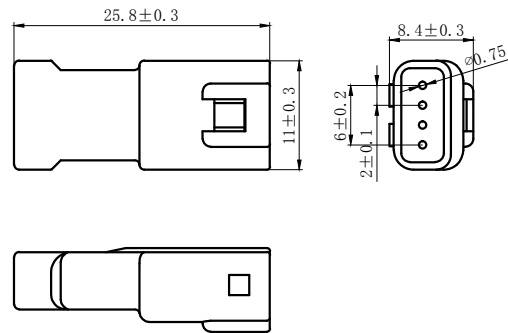

DL20023-6R-0.75

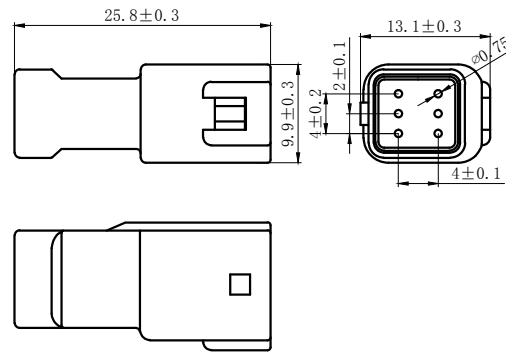

### NOTES

Available in 02.03.04.06.08 Circuits.  
 Mates with DL20023-Y Series Housing.  
 Material : PBT UL94V-0(2).  
 Accepts DL20023-RT Crimp Terminal.  
 Green Material RoHS Compliant.

GENERAL TOLERANCES (UNLESS SPECIFIED)		ZHE JIANG DELI CONNECTORS CO., LTD	
.X: ± 0.30	X° : ± 3.0°	PRODUCT NAME: DL20023-R-0.75	TITLE: 2.0 mm Pitch Wire To Wire Receptacle Housing
.XX: ± 0.15	.X° : ± 2.0°	DR:Chen Quan Long	DATE:21/08/01
.XXX: ± 0.01	.XX° : ± 1.0°	CHKD:Wu Hui	DATE:21/08/01
FINISH: _____		APPD:Ren An De	DATE:21/08/01
DRAWING NO:		SCALE: N/A	PAGE:1/2
		UNITS: mm	REV.: A

DL20023-10Y-0.75

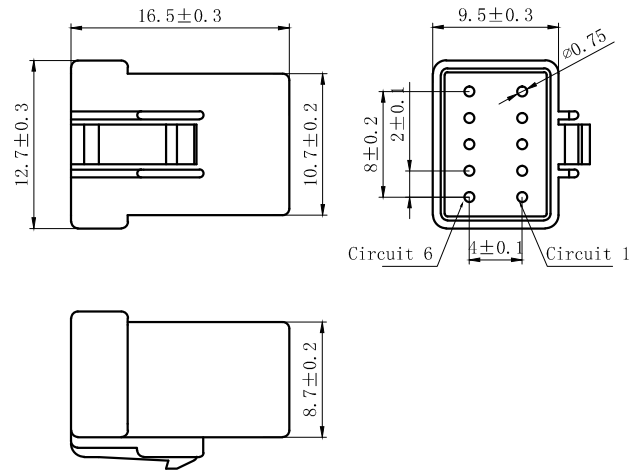

DL20023-12Y-0.75

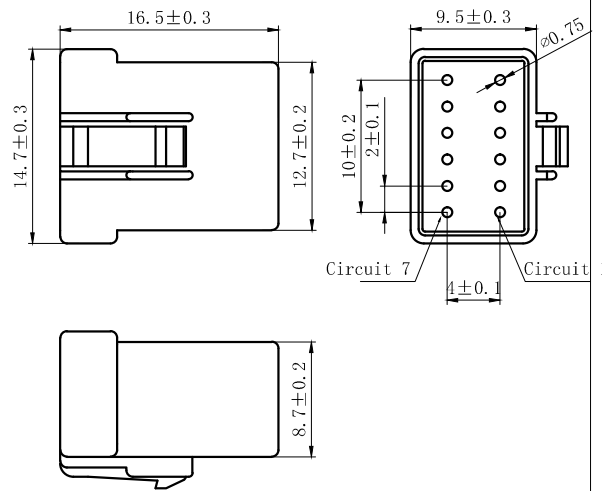

DL20023-14Y-0.75

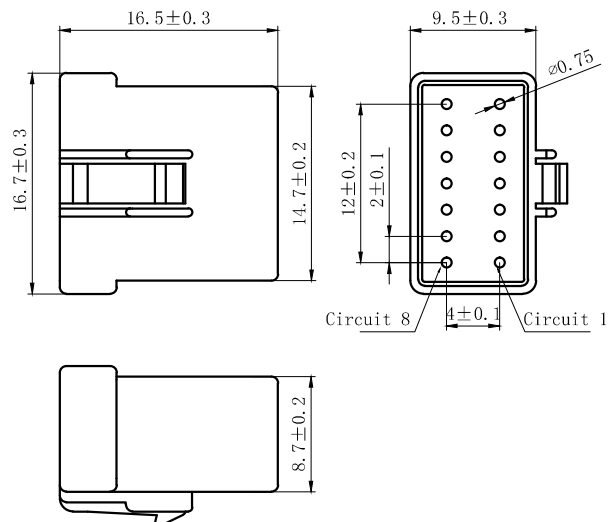

REV.	REVISION DESCRIPTION	DATE	APPD

NOTES

Available in 10.12.14 Circuits.  
 Mates with DL20023 Series Housing.  
 Material : PBT UL94V-0(2).  
 Accepts DL20023-T Crimp Terminal.  
 Green Material RoHS Compliant.

GENERAL TOLERANCES (UNLESS SPECIFIED)		ZHE JIANG DELI CONNECTORS CO.,LTD	
.X: ± 0.30	X° ± 3.0°	PRODUCT NAME: DL20023-Y-0.75	TITLE: 2.0 mm Pitch Housing
.XX: ± 0.15	.X° ± 2.0°	DR:Chen Quan Long	DATE:21/08/01
.XXX: ± 0.01	.X° ± 1.0°	CHKD:Wu Hui	DATE:21/08/01
FINISH: _____		APPD:Ren An De	DATE:21/08/01
DRAWING NO:			

REV.	REVISION DESCRIPTION	DATE	APPD

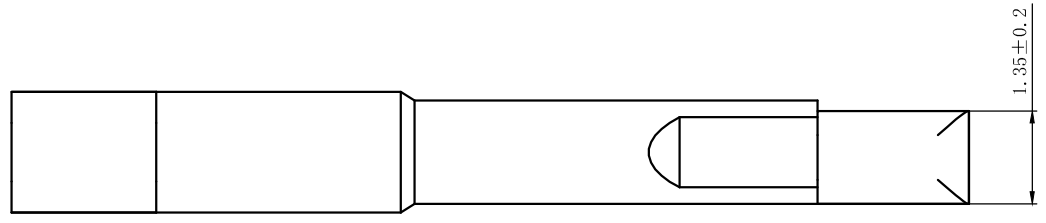
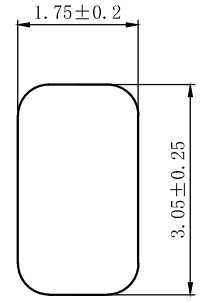
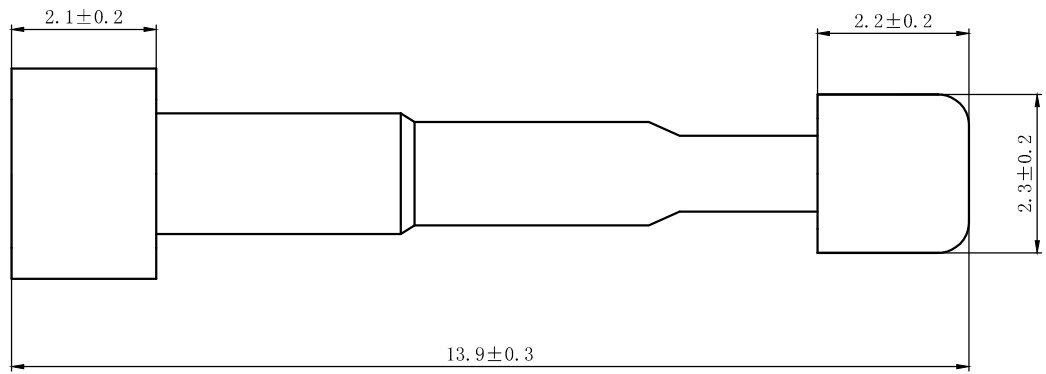

### NOTES

Mates with DL20023-Y or DL20023-R Series Housing.  
 Material : PBT UL94V-0 (2).  
 Green Material RoHS Compliant.

GENERAL TOLERANCES (UNLESS SPECIFIED)		ZHE JIANG DELI CONNECTORS CO., LTD	
.X: ± 0.30	X° : ± 3.0°	PRODUCT NAME: DL20023-1E	TITLE: 2.0 mm Pitch Wire To Wire Receptacle Stopper
.XX: ± 0.15	.X° : ± 2.0°	DR:KeXianQiang	DATE:17.10.12
.XXX: ± 0.01	.XX° : ± 1.0°	CHKD: Liu Bing	DATE:17.10.12
FINISH: _____		APPD:Ren An De	DATE:17.10.12
DRAWING NO:		SCALE: N/A	PAGE:1/1
		UNITS: mm	REV. : A



REV.	REVISION DESCRIPTION	DATE	APPD

### NOTES

Used in DL20023-Y Series Housing.  
 Accepts AWG #26~22 Wire Range.  
 0.13~ 0.33 mm<sup>2</sup> .  
 Insulation O. D. =1.4~1.7mm.  
 Material : Phosphor Bronze .  
 Finish: Tin plated.  
 Qty/Reel: 10,000 PCS.  
 Thickness: 0.25 mm.

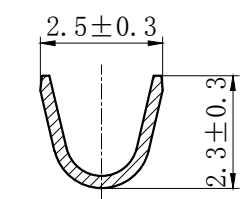
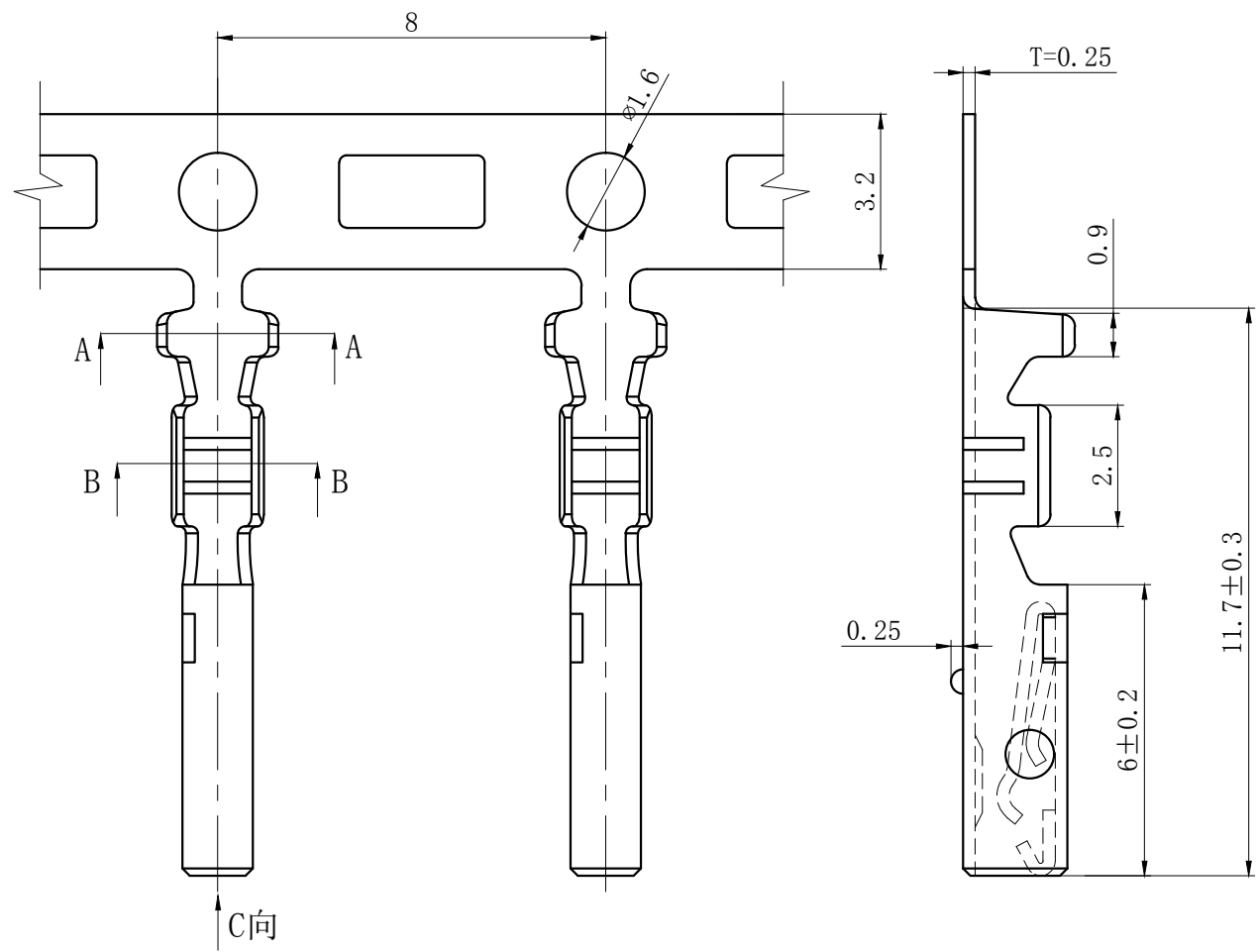

SECTION A-A

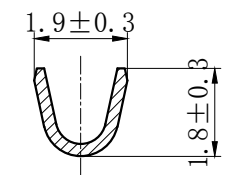

SECTION B-B

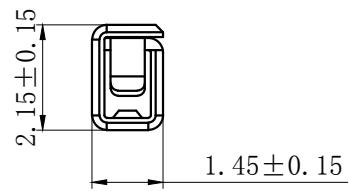

SECTION C-C

GENERAL TOLERANCES (UNLESS SPECIFIED)		ZHE JIANG DELI CONNECTORS CO., LTD	
.X: $\pm 0.25$	X°: $\pm 3.0^\circ$	PRODUCT NAME: DL20023-T	TITLE: 2.00 mm Pitch Crimp Terminal
.XX: $\pm 0.15$	.X°: $\pm 2.0^\circ$	DR: Chen Quan Long	DATE: 20/12/23
.XXX: $\pm 0.01$	.XX°: $\pm 1.0^\circ$	CHKD: Wu Hui	DATE: 20/12/23
DRAWING NO:		APPD: Ren An De	DATE: 20/12/23
		SCALE: N/A	PAGE: 1/1
		UNITS: mm	REV.: A

REV.	REVISION DESCRIPTION	DATE	APPD

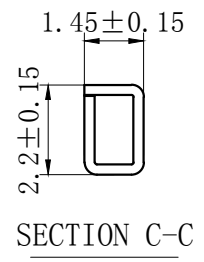
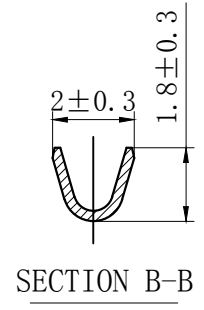
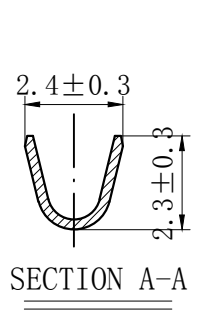
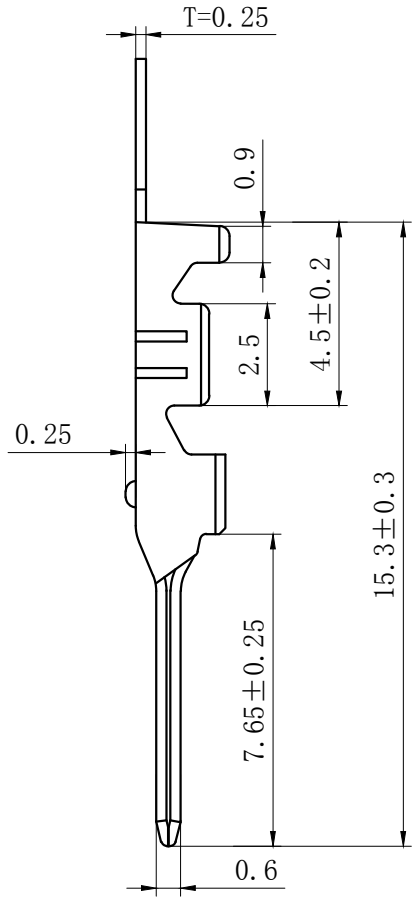
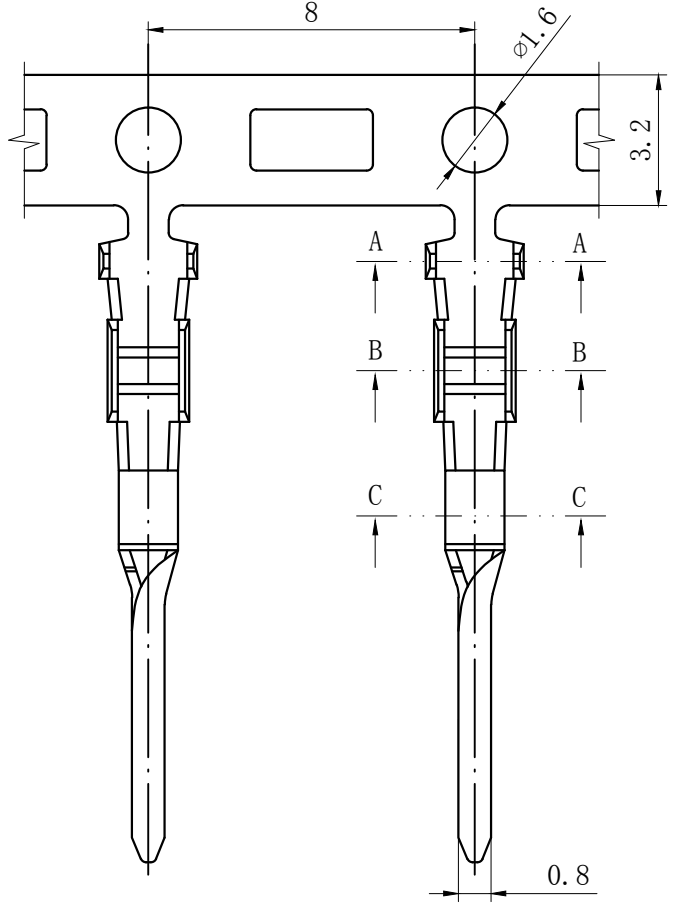

**NOTES**

Used in DL20023-R Series Housing.  
 Accepts AWG #26~22 Wire Range.  
 0.13~ 0.33 mm<sup>2</sup> .  
 Insulation O.D.=1.4~1.7mm.  
 Material : Phosphor Bronze .  
 Finish: Tin plated.  
 Qty/Reel: 10,000 PCS.  
 Thickness: 0.25 mm.

GENERAL TOLERANCES (UNLESS SPECIFIED)		ZHE JIANG DELI CONNECTORS CO., LTD	
.X: ± 0.25	X° : ± 3.0°	PRODUCT NAME: DL20023-RT	TITLE: 2.00 mm Pitch Wire To Wire Crimp Terminal
.XX: ± 0.15	.X° : ± 2.0°	DR:Chen Quan Long	DATE:20/12/23
.XXX: ± 0.01	.XX° : ± 1.0°	CHKD:Wu Hui	DATE:20/12/23
DRAWING NO:		APPD:Ren An De	DATE:20/12/23
		SCALE: N/A	PAGE: 1/1
		UNITS: mm	REV.: A

## X-ON Electronics

Largest Supplier of Electrical and Electronic Components

*Click to view similar products for [Headers & Wire Housings](#) category:*

*Click to view products by [DLL](#) manufacturer:*

Other Similar products are found below :

[0015917161](#) [0022155065](#) [57102-F02-18ULF](#) [58102-G61-06LF](#) [582553-1](#) [01.001.5753.1](#) [0050291907](#) [02.125.8002.8](#) [609-3404](#) [61062-3](#)  
[CSU011177004](#) [622-0430](#) [622-3653LF](#) [63453-116](#) [636-1030](#) [636-1427](#) [636-3427](#) [636-4007](#) [641938-9](#) [65495-038](#) [65692-001LF](#) [65781-018](#)  
[65781-047](#) [65817-010LF](#) [65817-015LF](#) [67095-007LF](#) [67601157](#) [68631-112](#) [68645-018](#) [699319-000](#) [70.362.1628.0](#) [70-4210](#) [70-4226B](#) [70-](#)  
[4853B](#) [71.350.2428.0](#) [733-134](#) [733-162](#) [MHR-64-VUAL](#) [80.063.4001.1](#) [800-90-001-10-001000](#) [801-43-002-10-013000](#) [801-43-006-10-](#)  
[002000](#) [803-43-024-10-001000](#) [803-93-012-10-001000](#) [8-1437020-4](#) [819-22-004-30-001101](#) [820-22-006-30-001101](#) [820-22-008-30-001101](#)  
[821-22-002-10-001101](#) [821-22-003-10-002101](#)