

技术特性/Specifications:

额定电压 Rated voltage: 100V AC, DC
额定电流 Rated current: 3A AC, DC
接触电阻 Contact resistance: 20m Ω max
绝缘电阻 Insulation resistance: 1000M Ω min
耐压 Withstand voltage: 1000V AC/minute
环境温度 Ambient temperature: -40 $^{\circ}$ C~+105 $^{\circ}$ C
适用线规 Wire range: AWG#26~#22

| REV. | REVISION DESCRIPTION | DATE | APPD |
|------|----------------------|--------|-------|
| B | 外形尺寸作调整 | 22.7.4 | Wuhui |

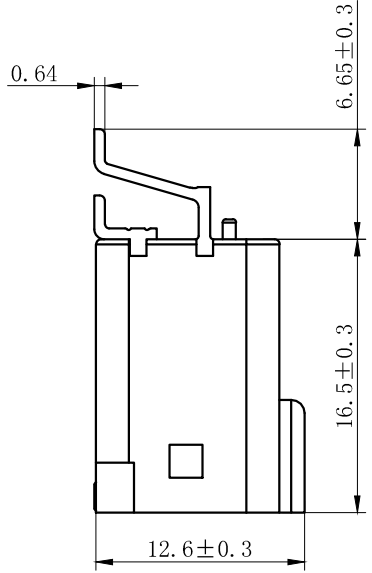
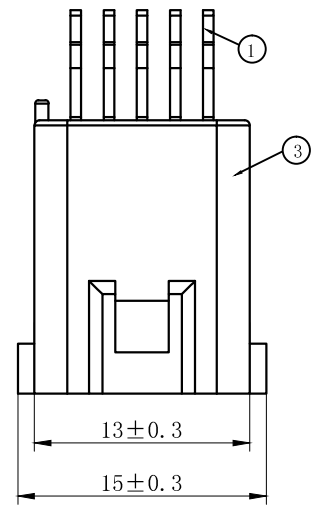
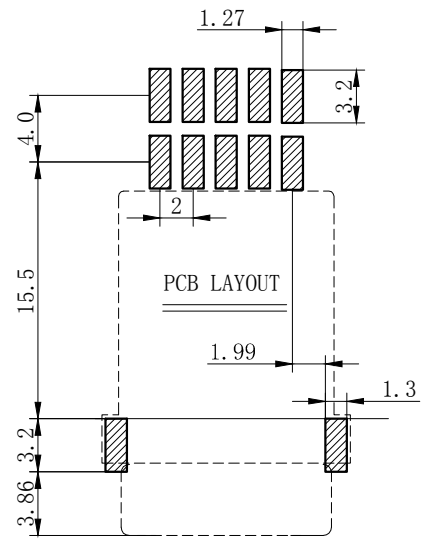
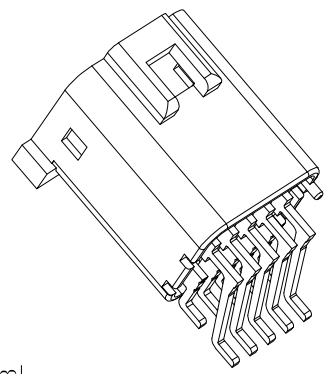
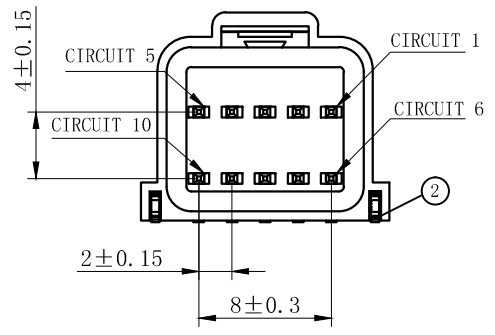

NOTES

Available in 10 Circuits.
 Mates with DL20023-Y Series Housing.
 Material : LCP UL94V-0.
 Pin Material : Brass.Tin-plated .
 Green Material RoHS Compliant.

| 序号 | 图号 | 名称 | 材料 | 数量 | 附件 |
|----|----|-----|-----|----|---------|
| 3 | ③ | 基座 | LCP | 1 | UL94V-0 |
| 2 | ② | 焊片 | 黄铜 | 2 | 镀锡 |
| 1 | ① | 接触件 | 黄铜 | N* | 镀锡 |

| GENERAL TOLERANCES (UNLESS SPECIFIED) | | ZHE JIANG DELI CONNECTORS CO ., LTD | |
|-----------------------------------------|---------------|----------------------------------------------|---------------|
| .X: ± 0.30 | X° : ± 3.0° | PRODUCT NAME: DL20023-10AWB | |
| .XX: ± 0.15 | .X° : ± 2.0° | TITLE: 2.00 mm Pitch Wire To Board SMT Wafer | |
| .XXX: ± 0.01 | .XX° : ± 1.0° | DR:Chen Quan Long | DATE:22.05.19 |
| FINISH: _____ | | CHKD: Wu Hui | DATE:22.05.19 |
| DRAWING NO: GC-DL20023-XXWB-XXX-XX-X-XX | | APPD: Ren An De | DATE:22.05.19 |
| | | SCALE: N/A | PAGE:1/1 |
| | | UNITS: mm | REV. : B |

| | | | |
|------|----------------------|------|------|
| REV. | REVISION DESCRIPTION | DATE | APPD |
|------|----------------------|------|------|

DL20023-2AS

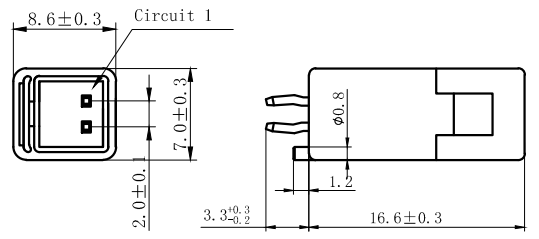

DL20023-6AS

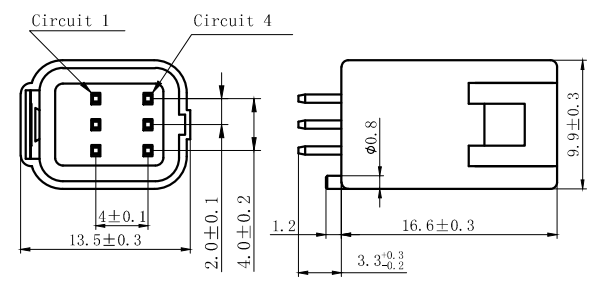

DL20023-3AS

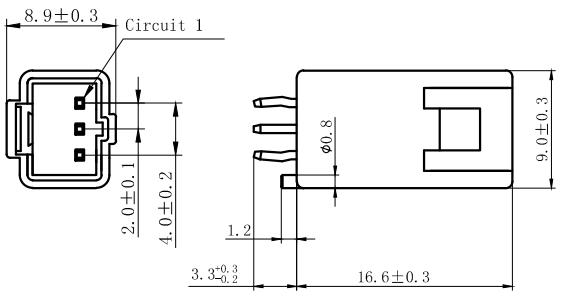

DL20023-8AS

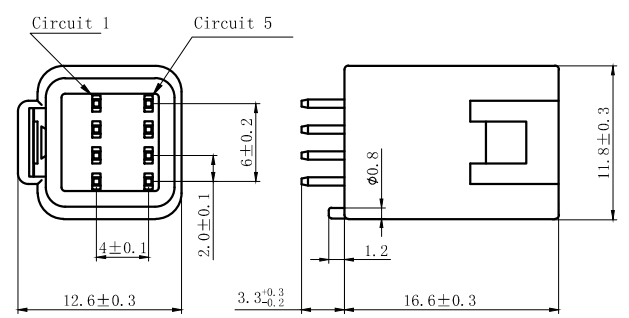

DL20023-4AS

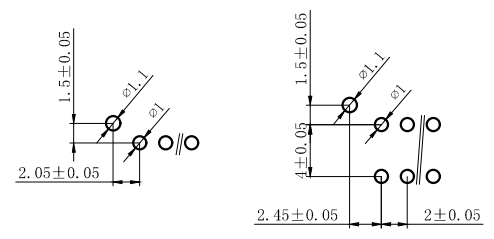
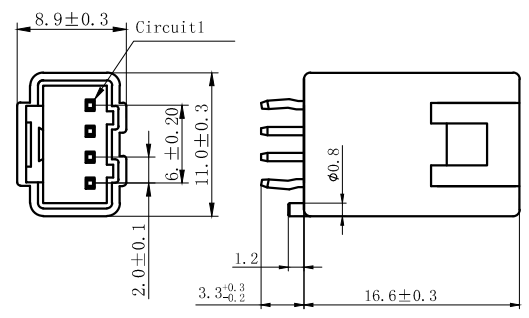

P. C. B LATOUT

NORES:

1. Rated voltage: 100V AC/DC
2. Rated current: 3A AC/DC
3. Contact resistance: $\leq 15 \text{ m}\Omega$
4. Insulation resistance: $\geq 1000 \text{ M}\Omega$
5. Withstand voltage: 1000V AC/minute
6. Ambient temperature: $-40^{\circ}\text{C} \sim 105^{\circ}\text{C}$
7. Materials: PBT UL94V-0(2).
8. Matched RoHS criteria

| | | | |
|---------------------------------------|-------------------------|------------------------------------|--------------------------------------------|
| GENERAL TOLERANCES (UNLESS SPECIFIED) | | ZHE JIANG DELI CONNECTORS CO., LTD | |
| .X: ± 0.30 | X°: $\pm 3.0^{\circ}$ | PRODUCT NAME: DL20023-AS | TITLE: 2.0 mm Pitch Wire To Board Wafer |
| .XX: ± 0.15 | .X°: $\pm 2.0^{\circ}$ | DR: Yuan Jun Rong | DATE: 20.10.12 |
| .XXX: ± 0.01 | .XX°: $\pm 1.0^{\circ}$ | DATE: 20.10.12 | PART NO: |
| FINISH: | | CHKD: Wu Hui | DATE: 20.10.12 |
| DRAWING NO: | | APPD: Ren An De | DATE: 20.10.12 |
| | | SCALE: N/A | PAGE: 1/2 |
| | | UNITS: mm | REV.: A |

| REV. | REVISION DESCRIPTION | DATE | APPD |
|------|----------------------|------|------|
| | | | |

DL20023-10AS

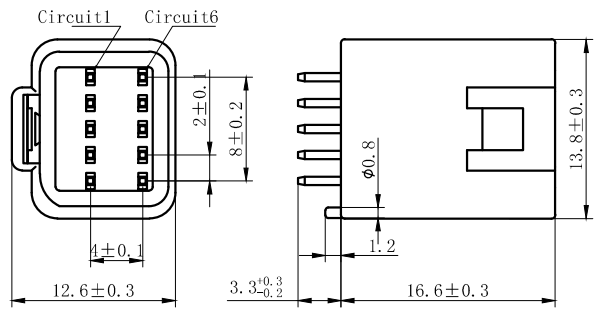

DL20023-12AS

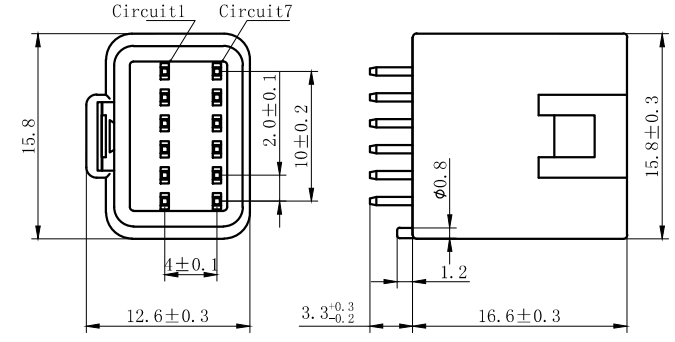

- NOES:
1. Rated voltage: 100V AC/DC
 2. Rated current: 3A AC/DC
 3. Contact resistance: $\leq 15 \text{ m}\Omega$
 4. Insulation resistance: $\geq 1000 \text{ M}\Omega$
 5. Withstand voltage: 1000V AC/minute
 6. Ambient temperature: $-40^\circ\text{C} \sim 105^\circ\text{C}$
 7. Materials: PBT UL94V-0(2).
 8. Matched RoHS criteria

DL20023-14AS

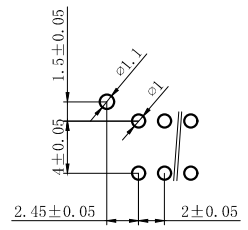
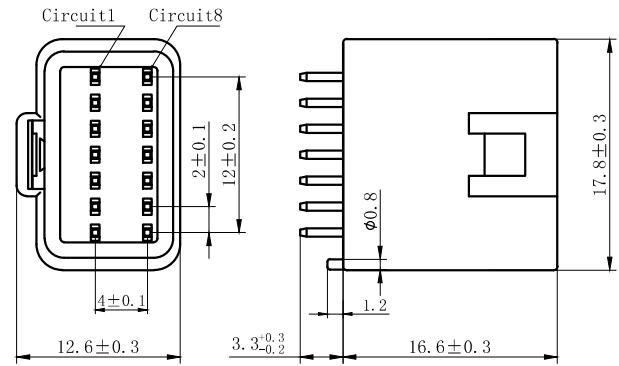

P. C. B LAYOUT

| GENERAL TOLERANCES (UNLESS SPECIFIED) | | ZHE JIANG DELI CONNECTORS CO., LTD | | | |
|---------------------------------------|-----------------------|------------------------------------|----------------|--------------------------------------------|-----------|
| .X: ± 0.30 | X°: $\pm 3.0^\circ$ | PRODUCT NAME: DL20023-AS | | TITLE: 2.0 mm Pitch Wire To Board Wafer | |
| .XX: ± 0.15 | .X°: $\pm 2.0^\circ$ | DR: Yuan Jun Rong | DATE: 20.10.12 | PART NO: | |
| .XXX: ± 0.01 | .XX°: $\pm 1.0^\circ$ | CHKD: Wu Hui | DATE: 20.10.12 | SCALE: N/A | PAGE: 2/2 |
| DRAWING NO: | | APPD: Ren An De | DATE: 20.10.12 | UNITS: mm | REV.: A |

DL20023-2AWS

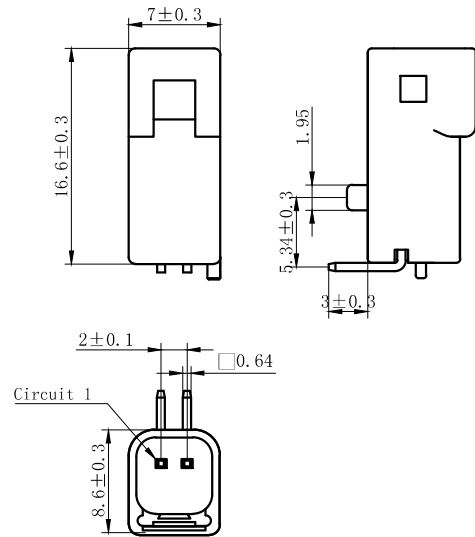

DL20023-3AWS

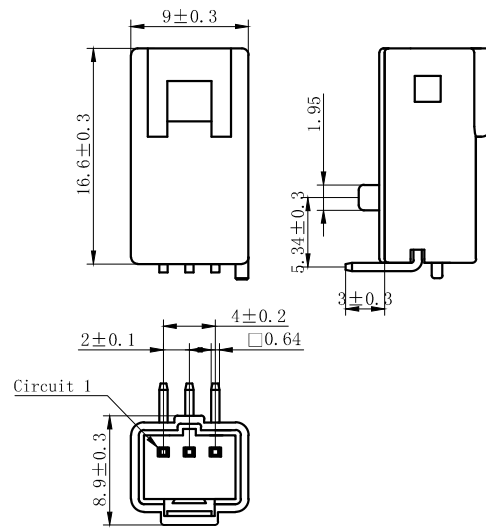

NORES:

1. Rated voltage: 100V AC/DC
2. Rated current: 3A AC/DC
3. Contact resistance: $\leq 15 \text{ m}\Omega$
4. Insulation resistance: $\geq 1000 \text{ M}\Omega$
5. Withstand voltage: 1000V AC/minute
6. Ambient temperature: $-40^\circ\text{C} \sim 105^\circ\text{C}$
7. Materials: PBT UL94V-0(2).
8. Matched RoHS criteria

DL20023-4AWS

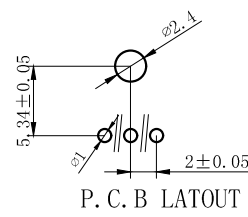
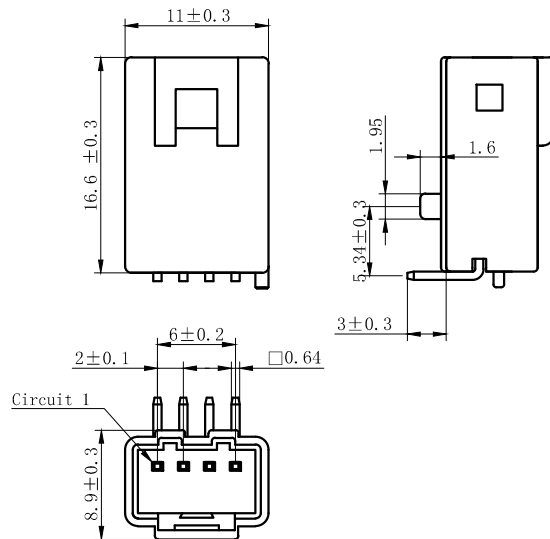

| | | | |
|---------------------------------------|-----------------------|------------------------------------|--------------------------------------------|
| GENERAL TOLERANCES (UNLESS SPECIFIED) | | ZHE JIANG DELI CONNECTORS CO., LTD | |
| .X: ± 0.30 | X°: $\pm 3.0^\circ$ | PRODUCT NAME: DL20023-AWS | TITLE: 2.0 mm Pitch Wire To Board Wafer |
| .XX: ± 0.15 | .X°: $\pm 2.0^\circ$ | DR: Yuan Jun Rong | DATE: 20.10.12 |
| .XXX: ± 0.01 | .XX°: $\pm 1.0^\circ$ | FINISH: | PART NO: |
| DRAWING NO: | | CHKD: Wu Hui | DATE: 20.10.12 |
| | | APPD: Ren An De | DATE: 20.10.12 |
| | | SCALE: N/A | PAGE: 1/3 |
| | | UNITS: mm | REV.: A |

| REV. | REVISION DESCRIPTION | DATE | APPD |
|------|----------------------|------|------|
| | | | |

DL20023-6AWS

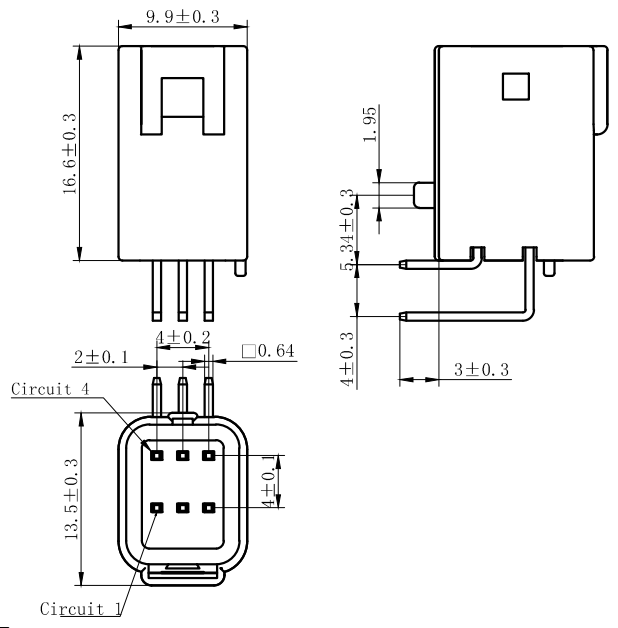

DL20023-8AWS

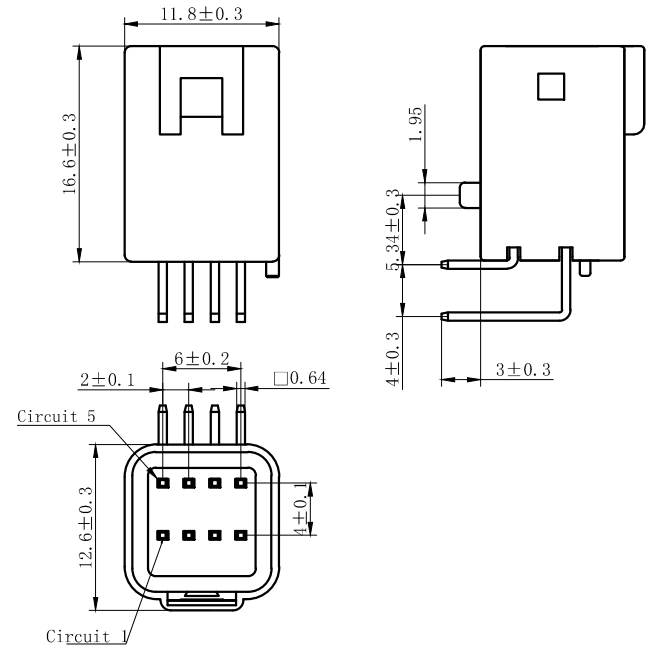

NORES:

1. Rated voltage: 100V AC/DC
2. Rated current: 3A AC/DC
3. Contact resistance: $\leq 15 \text{ m}\Omega$
4. Insulation resistance: $\geq 1000 \text{ M}\Omega$
5. Withstand voltage: 1000V AC/minute
6. Ambient temperature: $-40^\circ\text{C} \sim 105^\circ\text{C}$
7. Materials: PBT UL94V-0(2).
8. Matched RoHS criteria

DL20023-10AWS

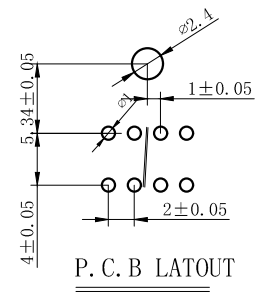
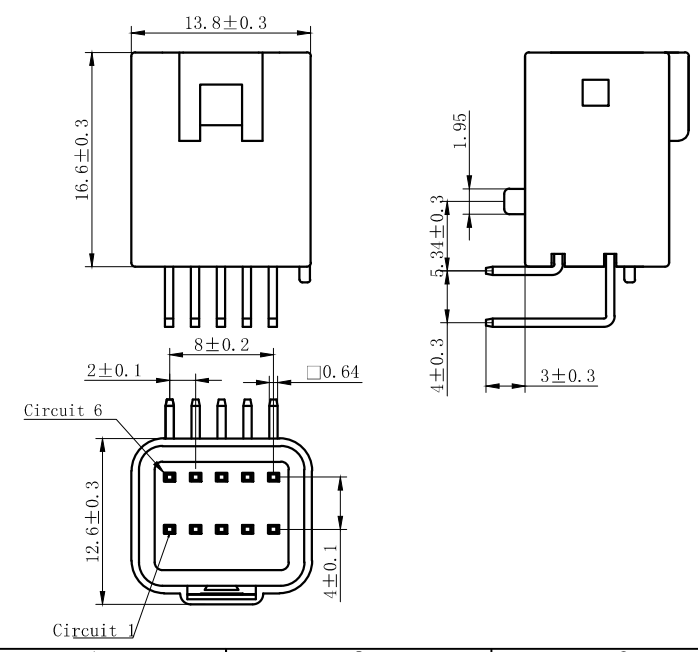

| GENERAL TOLERANCES (UNLESS SPECIFIED) | | ZHE JIANG DELI CONNECTORS CO., LTD | | | |
|---------------------------------------|-----------------------|------------------------------------|----------------|--------------------------------------------|------------|
| .X: ± 0.30 | X°: $\pm 3.0^\circ$ | PRODUCT NAME: DL20023-AWS | | TITLE: 2.0 mm Pitch Wire To Board Wafer | |
| .XX: ± 0.15 | .X°: $\pm 2.0^\circ$ | DR: Yuan Jun Rong | DATE: 20.10.12 | PART NO: | |
| .XXX: ± 0.01 | .XX°: $\pm 1.0^\circ$ | FINISH: _____ | CHKD: Wu Hui | DATE: 20.10.12 | SCALE: N/A |
| DRAWING NO: | | APPD: Ren An De | DATE: 20.10.12 | UNITS: mm | PAGE: 2/3 |
| | | | | REV.: A | |

DL20023-12AWS

DL20023-14AWS

NORES:

1. Rated voltage: 100V AC.DC
2. Rated current: 3A AC DC
3. Contact resistance: $\leq 15 \text{ m}\Omega$
4. Insulation resistance: $\geq 1000 \text{ M}\Omega$
5. Withstand voltage: 1000V AC/minute
6. Ambient temperature: $-40^{\circ}\text{C} \sim 105^{\circ}\text{C}$
7. Materials: PBT UL94V-0(2).
8. Matched RoHS criteria

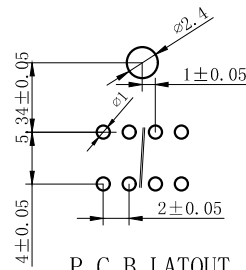
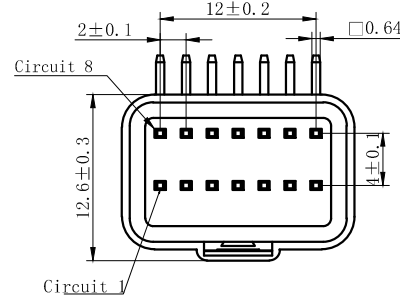
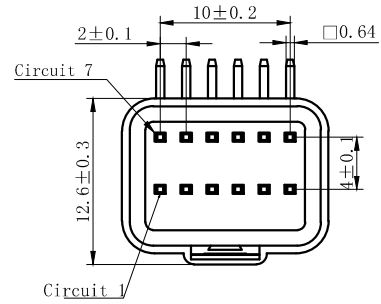
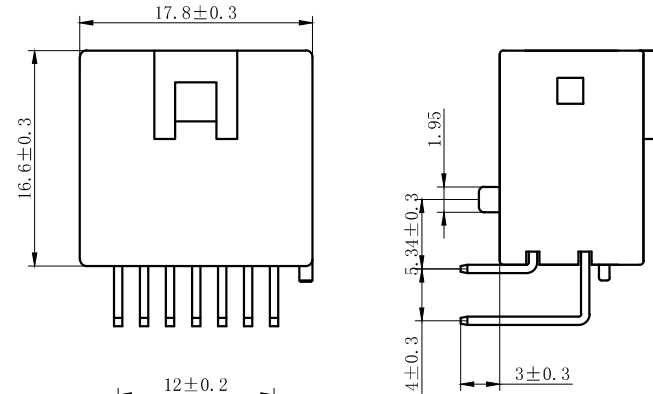
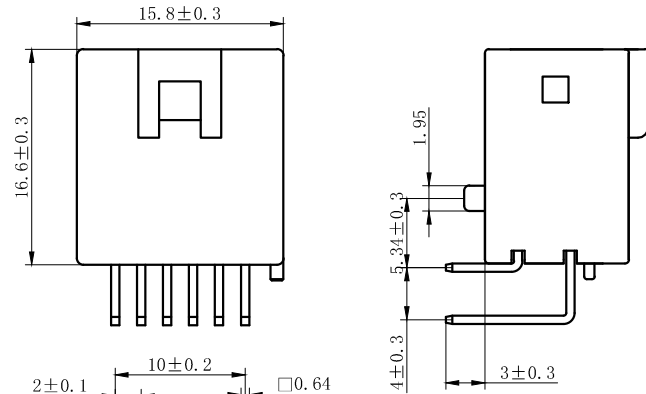

P. C. B LATOUT

| GENERAL TOLERANCES (UNLESS SPECIFIED) | | ZHE JIANG DELI CONNECTORS CO., LTD | |
|---------------------------------------|-------------------------|------------------------------------|--------------------------------------------|
| .X: ± 0.30 | X°: $\pm 3.0^{\circ}$ | PRODUCT NAME: DL20023-AWS | TITLE: 2.0 mm Pitch Wire To Board Wafer |
| .XX: ± 0.15 | .X°: $\pm 2.0^{\circ}$ | DR: Yuan Jun Rong | DATE: 20.10.12 |
| .XXX: ± 0.01 | .XX°: $\pm 1.0^{\circ}$ | CHKD: Wu Hui | DATE: 20.10.12 |
| DRAWING NO: | | APPD: Ren An De | DATE: 20.10.12 |
| | | PART NO: | SCALE: N/A |
| | | | PAGE: 3/3 |
| | | UNITS: mm | REV.: A |

DL20023-2Y

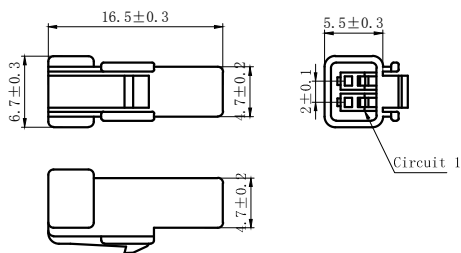

DL20023-3Y

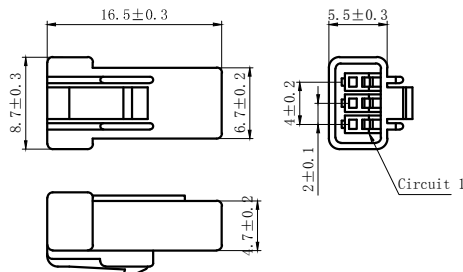

DL20023-8Y

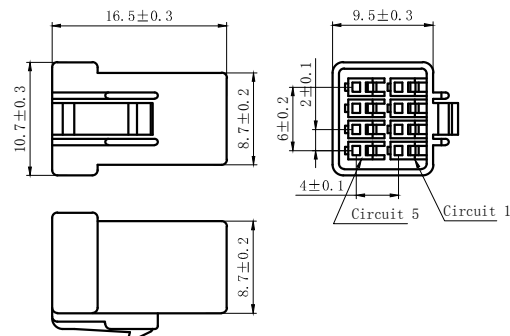

| REV. | REVISION DESCRIPTION | DATE | APPD |
|------|----------------------|------|------|
| | | | |

DL20023-4Y

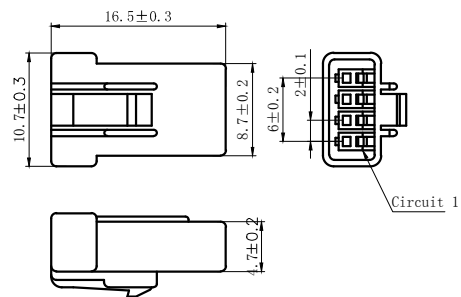

DL20023-6Y

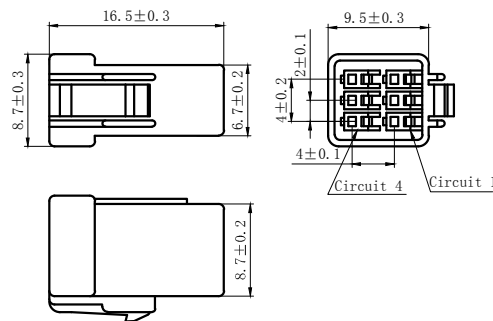

NOTES

Available in 02.03.04.06.08 Circuits.
 Mates with DL20023 Series Housing.
 Material : PBT UL94V-0(2).
 Accepts DL20023-T Crimp Terminal.
 Green Material RoHS Compliant.

| | | | |
|---------------------------------------|-------------|-----------------------------------|--------------------------------|
| GENERAL TOLERANCES (UNLESS SPECIFIED) | | ZHE JIANG DELI CONNECTORS CO.,LTD | |
| . X: ± 0.30 | X° ± 3.0° | PRODUCT NAME: DL20023-Y | TITLE: 2.0 mm Pitch Housing |
| . XX: ± 0.15 | . X° ± 2.0° | DR:Chen Quan Long | DATE:21/08/01 |
| . XXX: ± 0.01 | . X° ± 1.0° | CHKD:Wu Hui | DATE:21/08/01 |
| FINISH: | | APPD:Ren An De | DATE:21/08/01 |
| DRAWING NO: | | | |

| REV. | REVISION DESCRIPTION | DATE | APPD |
|------|----------------------|------|------|
| | | | |

DL20023-10Y

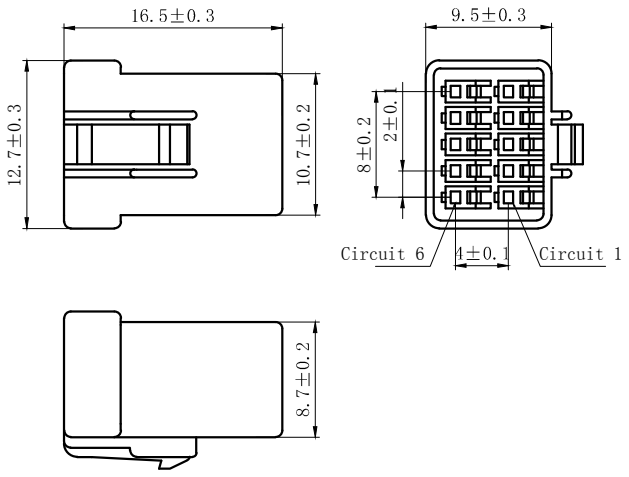

DL20023-12Y

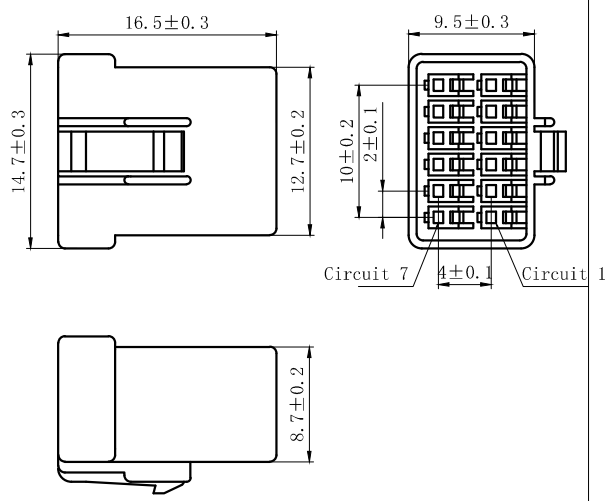

DL20023-14Y

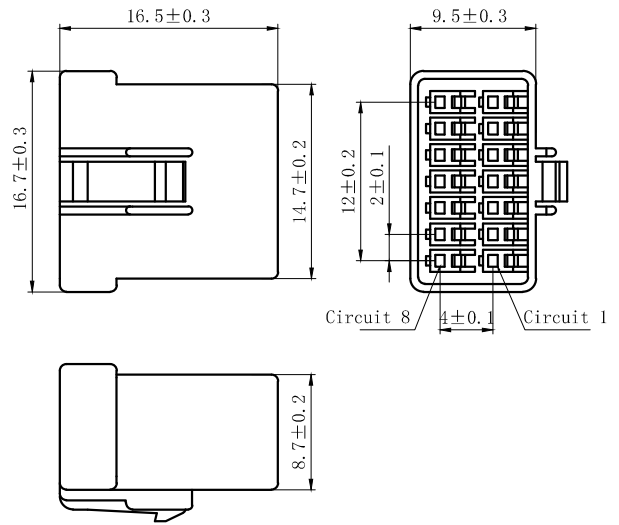

NOTES

Available in 10.12.14 Circuits.
 Mates with DL20023 Series Housing.
 Material : PBT UL94V-0(2).
 Accepts DL20023-T Crimp Terminal.
 Green Material RoHS Compliant.

| | | | |
|---------------------------------------|------------|------------------------------------|----------------|
| GENERAL TOLERANCES (UNLESS SPECIFIED) | | ZHE JIANG DELI CONNECTORS CO., LTD | |
| .X: ± 0.30 | X° ± 3.0° | PRODUCT NAME: | TITLE: |
| .XX: ± 0.15 | .X° ± 2.0° | DL20023-Y | |
| .XXX: ± 0.01 | .X° ± 1.0° | DR: Chen Quan Long | DATE: 21/08/01 |
| FINISH: | | CHKD: Wu Hui | DATE: 21/08/01 |
| DRAWING NO: | | APPD: Ren An De | DATE: 21/08/01 |
| | | PART NO: 2.0 mm Pitch Housing | |
| | | SCALE: N/A | PAGE: 2/2 |
| | | UNITS: mm | REV.: A |

DL20023-2Y-0.75

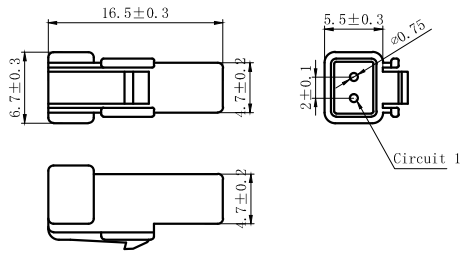

DL20023-3Y-0.75

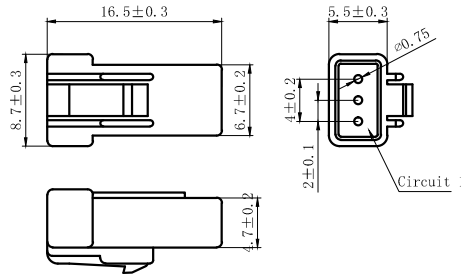

DL20023-8Y-0.75

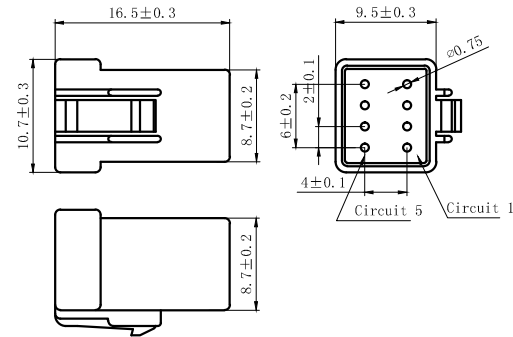

| REV. | REVISION DESCRIPTION | DATE | APPD |
|------|----------------------|------|------|
| | | | |

DL20023-4Y-0.75

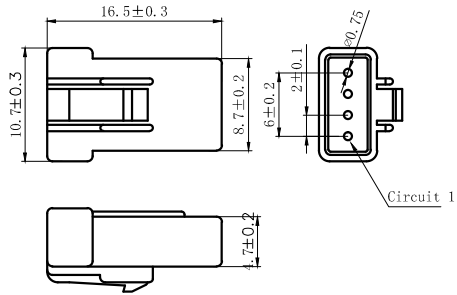

DL20023-6Y-0.75

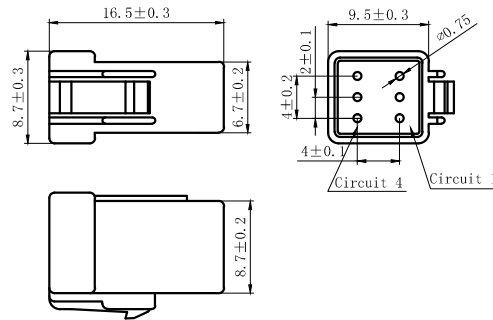

NOTES

Available in 02.03.04.06.08 Circuits.
 Mates with DL20023 Series Housing.
 Material : PBT UL94V-0(2).
 Accepts DL20023-T Crimp Terminal.
 Green Material RoHS Compliant.

| | | | |
|---------------------------------------|------------|-----------------------------------|--------------------------------|
| GENERAL TOLERANCES (UNLESS SPECIFIED) | | ZHE JIANG DELI CONNECTORS CO.,LTD | |
| .X: ± 0.30 | X° ± 3.0° | PRODUCT NAME: DL20023-Y-0.75 | TITLE: 2.0 mm Pitch Housing |
| .XX: ± 0.15 | .X° ± 2.0° | DR:Chen Quan Long | DATE:21/08/01 |
| .XXX: ± 0.01 | .X° ± 1.0° | CHKD:Wu Hui | DATE:21/08/01 |
| FINISH: | | APPD:Ren An De | DATE:21/08/01 |
| DRAWING NO: | | | |

| | |
|------------|----------|
| PART NO: | |
| SCALE: N/A | PAGE:1/2 |
| UNITS: mm | REV.: A |

| REV. | REVISION DESCRIPTION | DATE | APPD |
|------|----------------------|------|------|
| | | | |

DL20023-10R-0.75

DL20023-12R-0.75

DL20023-14R-0.75

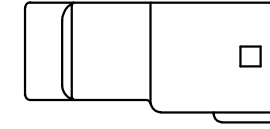
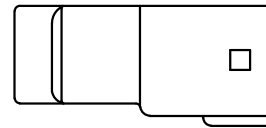
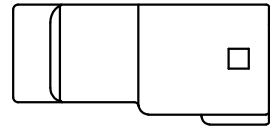
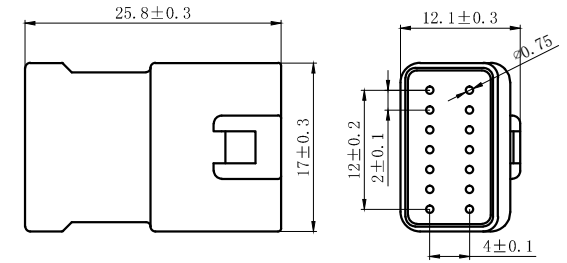
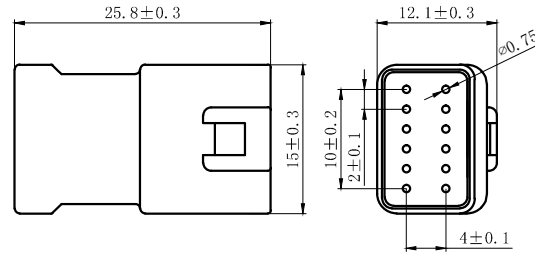
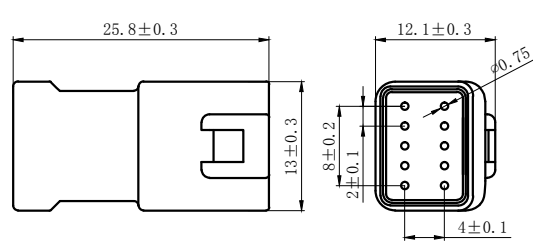

NOTES

- Available in 10.12.14 Circuits.
- Mates with DL20023-Y Series Housing.
- Material : PBT UL94V-0(2).
- Accepts DL20023-RT Crimp Terminal.
- Green Material RoHS Compliant.

| | | | |
|---------------------------------------|---------------|------------------------------------|-------------------------------------------------|
| GENERAL TOLERANCES (UNLESS SPECIFIED) | | ZHE JIANG DELI CONNECTORS CO., LTD | |
| .X: ± 0.30 | X° : ± 3.0° | PRODUCT NAME: | TITLE: |
| .XX: ± 0.15 | .X° : ± 2.0° | DL20023-R-0.75 | 2.0 mm Pitch Wire To Wire Receptacle Housing |
| .XXX: ± 0.01 | .XX° : ± 1.0° | DR:Chen Quan Long | DATE:21/08/01 |
| FINISH: | | CHKD:Wu Hui | DATE:21/08/01 |
| DRAWING NO: | | APPD:Ren An De | DATE:21/08/01 |
| | | | SCALE: N/A |
| | | | PAGE:2/2 |
| | | | UNITS: mm |
| | | | REV. : A |

| REV. | REVISION DESCRIPTION | DATE | APPD |
|------|----------------------|------|------|
| | | | |

DL20023-2R

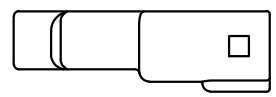
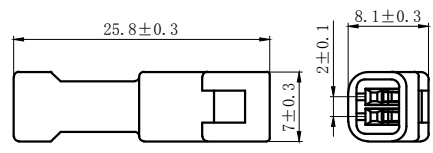

DL20023-3R

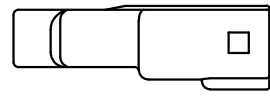
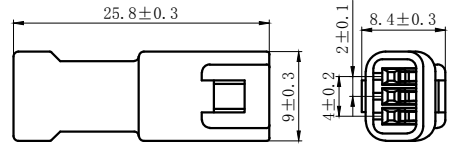

DL20023-8R

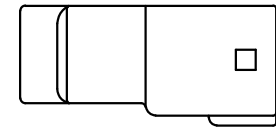
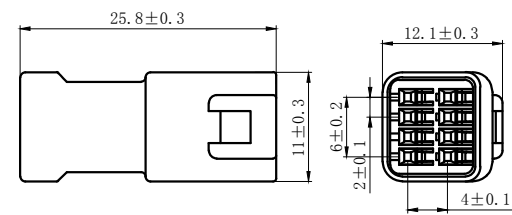

DL20023-4R

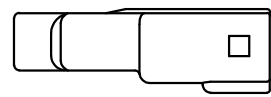
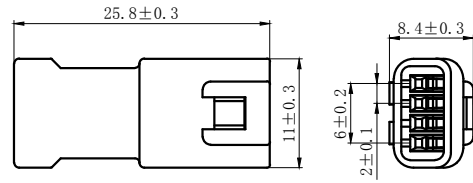

DL20023-6R

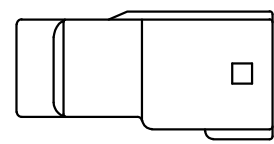
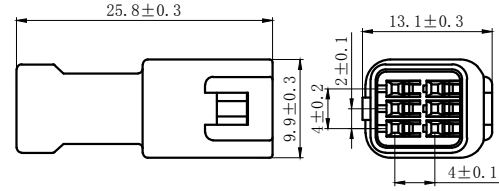

NOTES

Available in 02.03.04.06.08 Circuits.
Mates with DL20023-Y Series Housing.
Material : PBT UL94V-0(2).
Accepts DL20023-RT Crimp Terminal.
Green Material RoHS Compliant.

| | | | |
|---------------------------------------|---------------|------------------------------------|-------------------------------------------------|
| GENERAL TOLERANCES (UNLESS SPECIFIED) | | ZHE JIANG DELI CONNECTORS CO., LTD | |
| .X: ± 0.30 | X° : ± 3.0° | PRODUCT NAME: | TITLE: |
| .XX: ± 0.15 | .X° : ± 2.0° | DL20023-R | 2.0 mm Pitch Wire To Wire Receptacle Housing |
| .XXX: ± 0.01 | .XX° : ± 1.0° | DR:Chen Quan Long | DATE:21/08/01 |
| FINISH: | | CHKD:Wu Hui | DATE:21/08/01 |
| DRAWING NO: | | APPD:Ren An De | DATE:21/08/01 |
| | | SCALE: N/A | PAGE:1/2 |
| | | UNITS: mm | REV.: A |

| REV. | REVISION DESCRIPTION | DATE | APPD |
|------|----------------------|------|------|
| | | | |

DL20023-10R

DL20023-12R

DL20023-14R

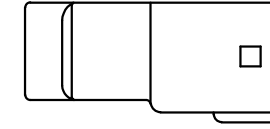
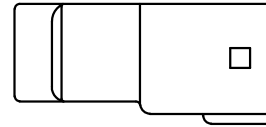
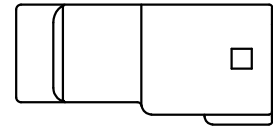
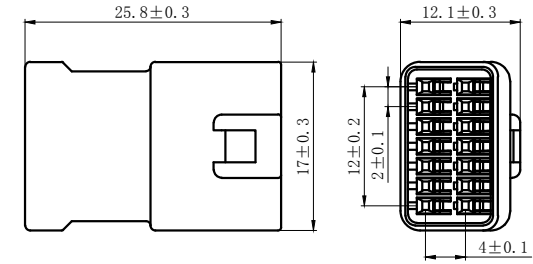
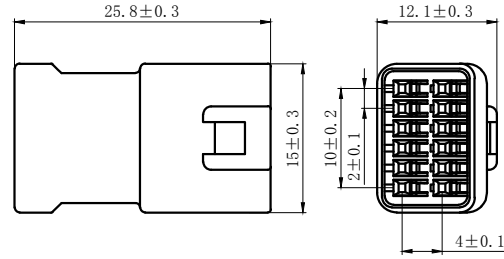
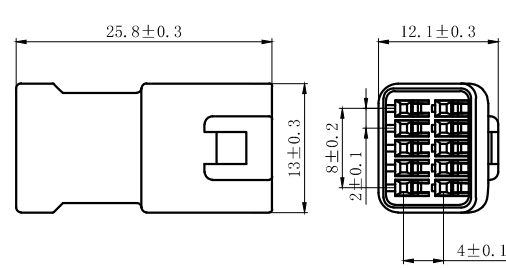

NOTES

- Available in 10.12.14 Circuits.
- Mates with DL20023-Y Series Housing.
- Material : PBT UL94V-0(2).
- Accepts DL20023-RT Crimp Terminal.
- Green Material RoHS Compliant.

| | | | |
|---------------------------------------|---------------|------------------------------------|-----------------------------------------------------------|
| GENERAL TOLERANCES (UNLESS SPECIFIED) | | ZHE JIANG DELI CONNECTORS CO., LTD | |
| .X: ± 0.30 | X° : ± 3.0° | PRODUCT NAME: DL20023-R | TITLE: 2.0 mm Pitch Wire To Wire Receptacle Housing |
| .XX: ± 0.15 | .X° : ± 2.0° | DR:Chen Quan Long | DATE:21/08/01 |
| .XXX: ± 0.01 | .XX° : ± 1.0° | CHKD:Wu Hui | DATE:21/08/01 |
| FINISH: _____ | | APPD:Ren An De | DATE:21/08/01 |
| DRAWING NO: | | UNITS: mm | REV. : A |

| REV. | REVISION DESCRIPTION | DATE | APPD |
|------|----------------------|------|------|
| | | | |

DL20023-2R-0.75

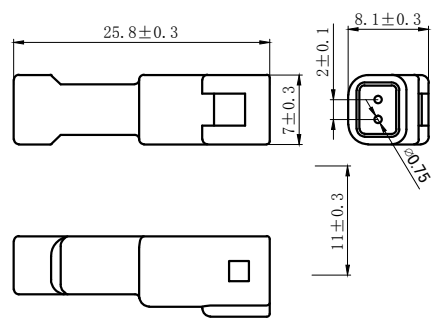

DL20023-3R-0.75

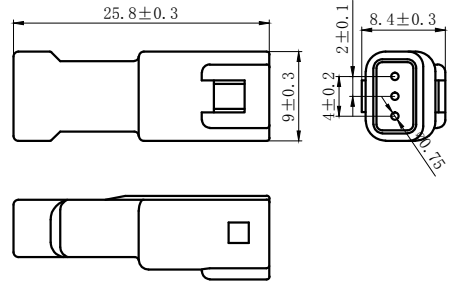

DL20023-8R-0.75

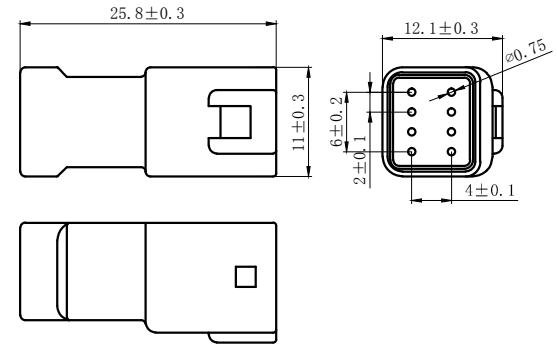

DL20023-4R-0.75

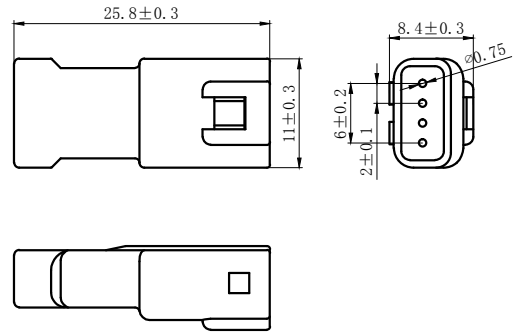

DL20023-6R-0.75

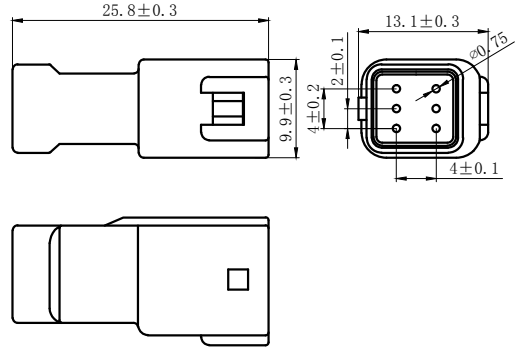

NOTES

Available in 02.03.04.06.08 Circuits.
Mates with DL20023-Y Series Housing.
Material : PBT UL94V-0(2).
Accepts DL20023-RT Crimp Terminal.
Green Material RoHS Compliant.

| | | | |
|---------------------------------------|---------------|------------------------------------|-----------------------------------------------------------|
| GENERAL TOLERANCES (UNLESS SPECIFIED) | | ZHE JIANG DELI CONNECTORS CO., LTD | |
| .X: ± 0.30 | X° : ± 3.0° | PRODUCT NAME: DL20023-R-0.75 | TITLE: 2.0 mm Pitch Wire To Wire Receptacle Housing |
| .XX: ± 0.15 | .X° : ± 2.0° | DR:Chen Quan Long | DATE:21/08/01 |
| .XXX: ± 0.01 | .XX° : ± 1.0° | CHKD:Wu Hui | DATE:21/08/01 |
| FINISH: _____ | | APPD:Ren An De | DATE:21/08/01 |
| DRAWING NO: | | SCALE: N/A | PAGE:1/2 |
| | | UNITS: mm | REV.: A |

DL20023-10Y-0.75

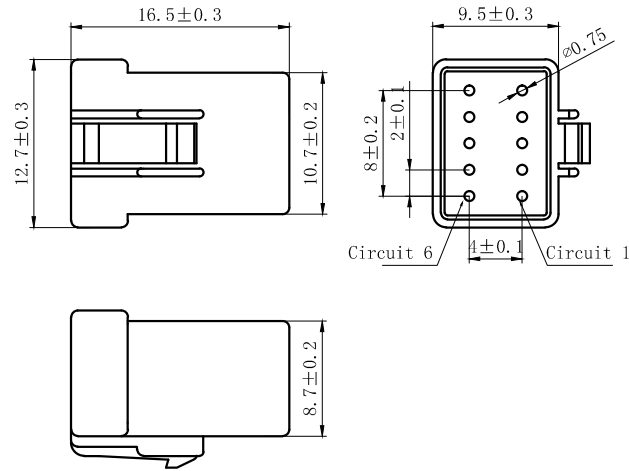

DL20023-12Y-0.75

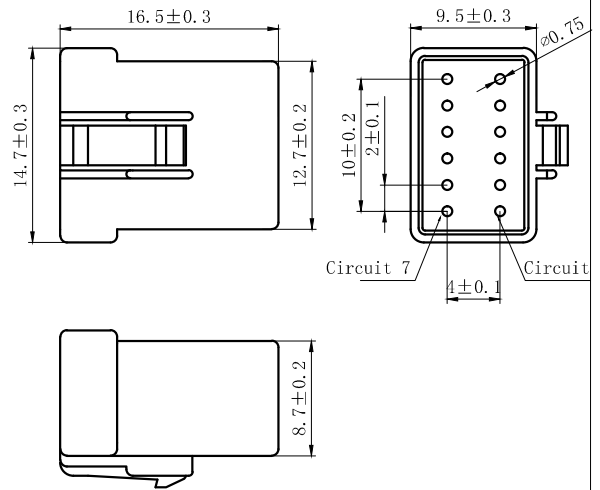

DL20023-14Y-0.75

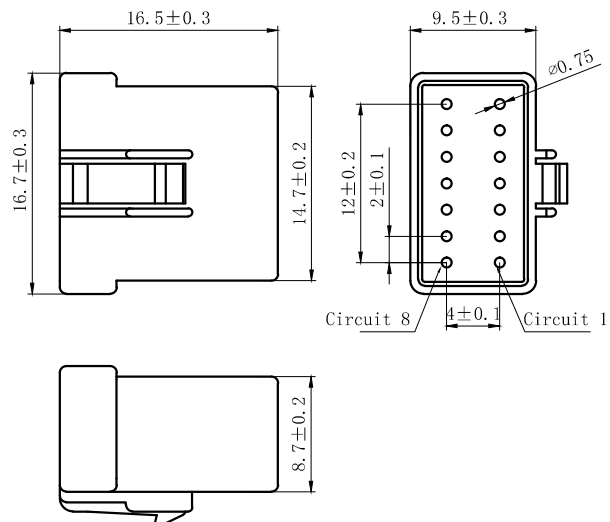

| REV. | REVISION DESCRIPTION | DATE | APPD |
|------|----------------------|------|------|
| | | | |

NOTES

Available in 10.12.14 Circuits.
 Mates with DL20023 Series Housing.
 Material : PBT UL94V-0(2).
 Accepts DL20023-T Crimp Terminal.
 Green Material RoHS Compliant.

| | | | |
|------------------------------------------|------------|-----------------------------------|--------------------------------|
| GENERAL TOLERANCES (UNLESS SPECIFIED) | | ZHE JIANG DELI CONNECTORS CO.,LTD | |
| .X: ± 0.30 | X° ± 3.0° | PRODUCT NAME: DL20023-Y-0.75 | TITLE: 2.0 mm Pitch Housing |
| .XX: ± 0.15 | .X° ± 2.0° | DR:Chen Quan Long | DATE:21/08/01 |
| .XXX: ± 0.01 | .X° ± 1.0° | CHKD:Wu Hui | DATE:21/08/01 |
| FINISH: _____ | | APPD:Ren An De | DATE:21/08/01 |
| DRAWING NO: | | | |

1 2 3 4 5 6 7 8

| REV. | REVISION DESCRIPTION | DATE | APPD |
|------|----------------------|------|------|
| | | | |

A

A

B

B

C

C

D

D

E

E

F

F

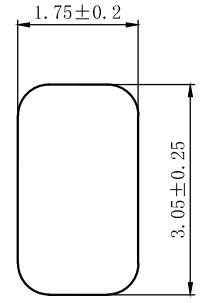
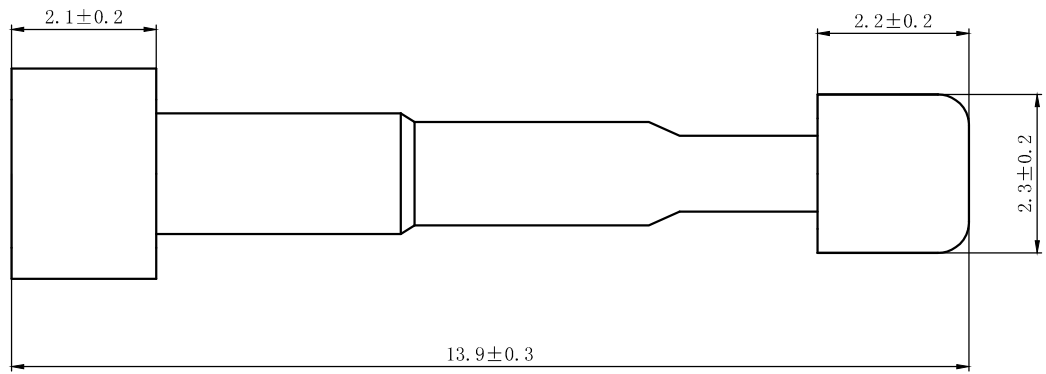

NOTES

Mates with DL20023-Y or DL20023-R Series Housing.
 Material : PBT UL94V-0 (2).
 Green Material RoHS Compliant.

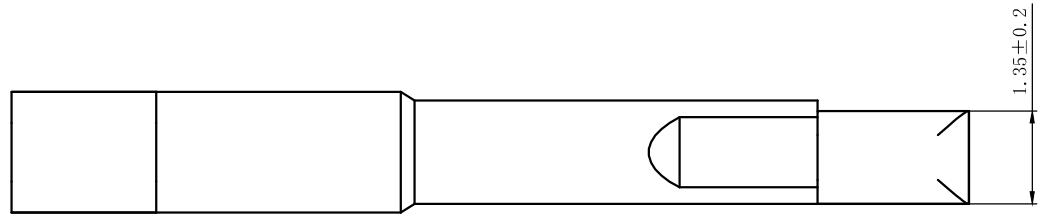

| | | | |
|---------------------------------------|---------------|------------------------------------|-----------------------------------------------------------|
| GENERAL TOLERANCES (UNLESS SPECIFIED) | | ZHE JIANG DELI CONNECTORS CO., LTD | |
| .X: ± 0.30 | X° : ± 3.0° | PRODUCT NAME: DL20023-1E | TITLE: 2.0 mm Pitch Wire To Wire Receptacle Stopper |
| .XX: ± 0.15 | .X° : ± 2.0° | DR:KeXianQiang | DATE:17.10.12 |
| .XXX: ± 0.01 | .XX° : ± 1.0° | CHKD: Liu Bing | DATE:17.10.12 |
| FINISH: _____ | | APPD:Ren An De | DATE:17.10.12 |
| DRAWING NO: | | SCALE: N/A | PAGE:1/1 |
| | | UNITS: mm | REV. : A |

1 2 3 4 5 6 7 8

| REV. | REVISION DESCRIPTION | DATE | APPD |
|------|----------------------|------|------|
| | | | |

NOTES

Used in DL20023-Y Series Housing.
 Accepts AWG #26~22 Wire Range.
 0.13~ 0.33 mm² .
 Insulation O. D. =1.4~1.7mm.
 Material : Phosphor Bronze .
 Finish: Tin plated.
 Qty/Reel: 10,000 PCS.
 Thickness: 0.25 mm.

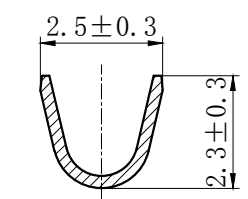
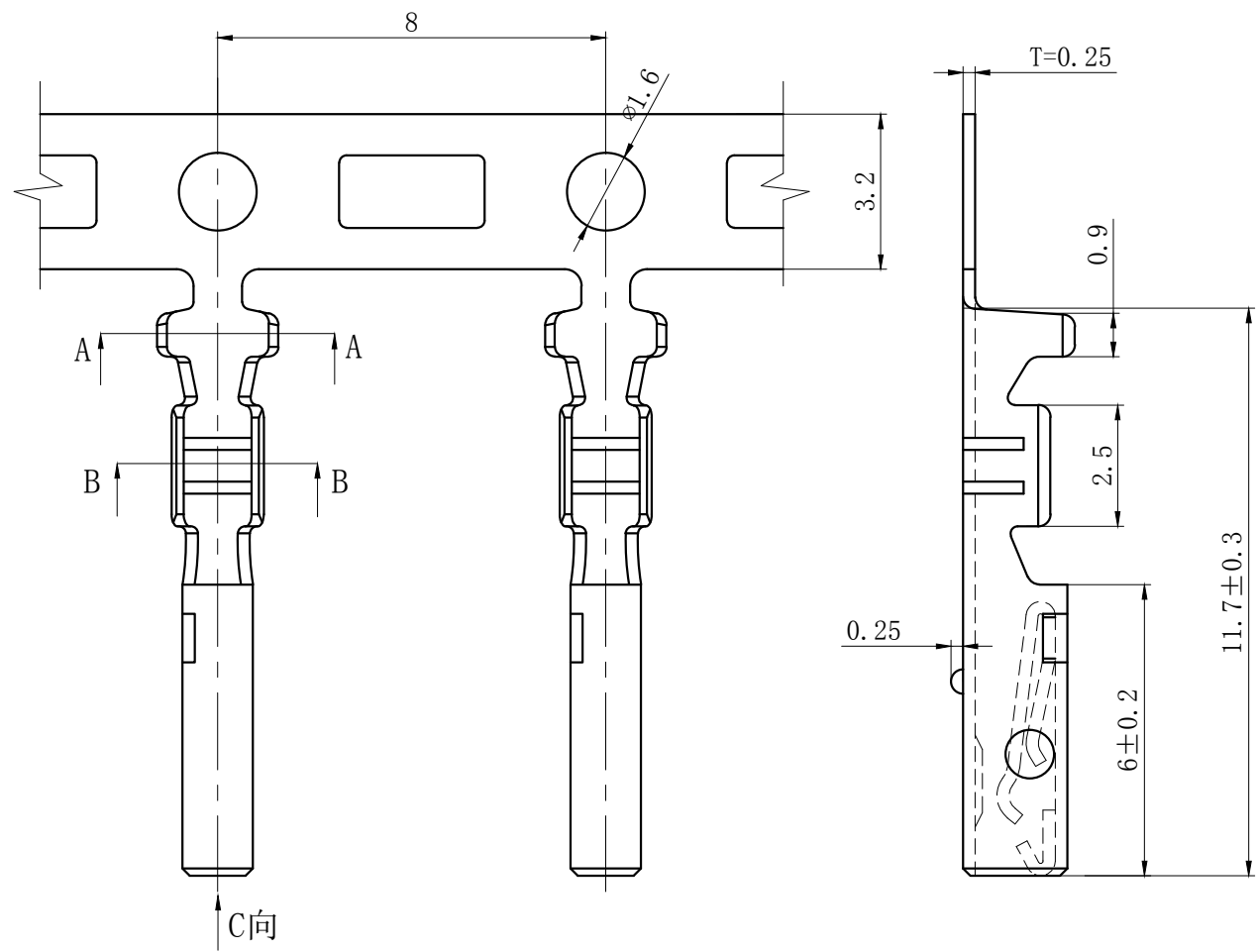

SECTION A-A

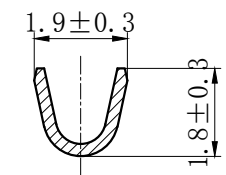

SECTION B-B

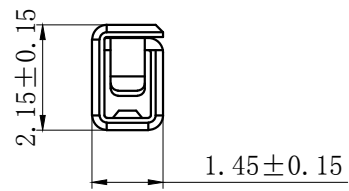

SECTION C-C

| GENERAL TOLERANCES (UNLESS SPECIFIED) | | ZHE JIANG DELI CONNECTORS CO., LTD | |
|------------------------------------------|---------------|------------------------------------|-------------------------------------------|
| .X: ± 0.25 | X° : ± 3.0° | PRODUCT NAME: DL20023-T | TITLE: 2.00 mm Pitch Crimp Terminal |
| .XX: ± 0.15 | .X° : ± 2.0° | DR:Chen Quan Long | DATE:20/12/23 |
| .XXX: ± 0.01 | .XX° : ± 1.0° | CHKD:Wu Hui | DATE:20/12/23 |
| DRAWING NO: | | APPD:Ren An De | DATE:20/12/23 |
| | | SCALE: N/A | PAGE: 1/1 |
| | | UNITS: mm | REV.: A |

| REV. | REVISION DESCRIPTION | DATE | APPD |
|------|----------------------|------|------|
| | | | |
| | | | |

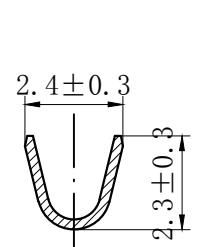
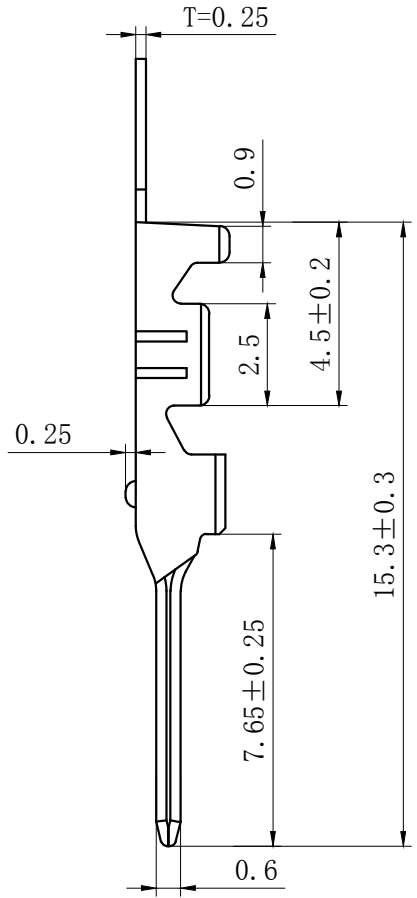
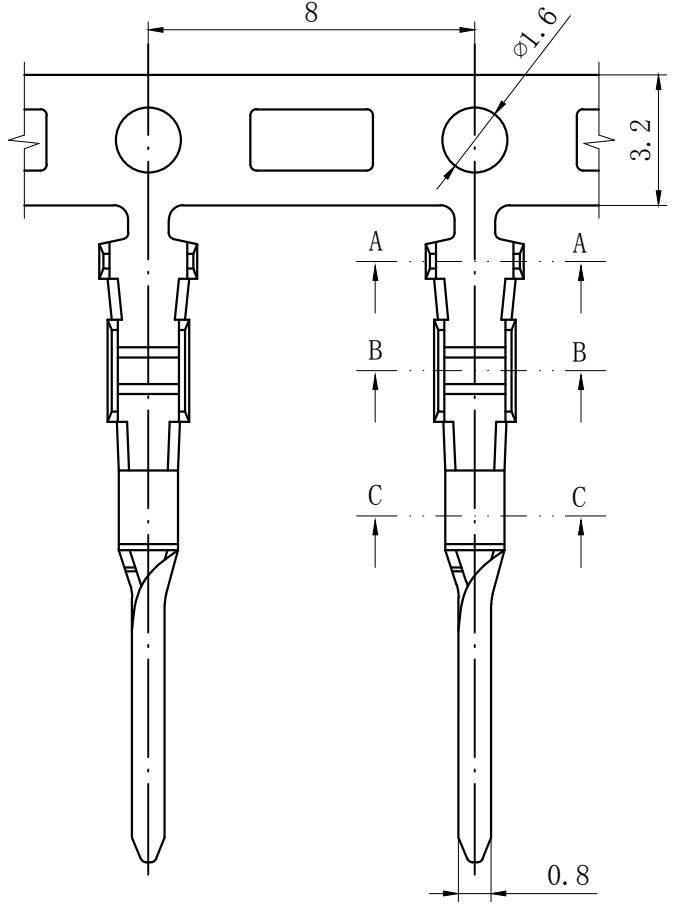

SECTION A-A

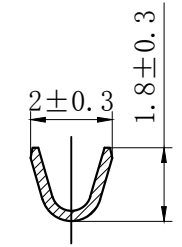

SECTION B-B

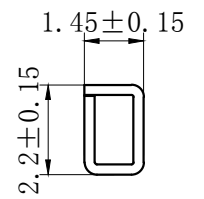

SECTION C-C

NOTES

- Used in DL20023-R Series Housing.
- Accepts AWG #26~22 Wire Range.
0.13~ 0.33 mm².
- Insulation O.D.=1.4~1.7mm.
- Material : Phosphor Bronze .
- Finish: Tin plated.
- Qty/Reel: 10,000 PCS.
- Thickness: 0.25 mm.

| GENERAL TOLERANCES (UNLESS SPECIFIED) | | ZHE JIANG DELI CONNECTORS CO., LTD | |
|------------------------------------------|---------------|------------------------------------|--------------------------------------------------------|
| .X: ± 0.25 | X° : ± 3.0° | PRODUCT NAME: DL20023-RT | TITLE: 2.00 mm Pitch Wire To Wire Crimp Terminal |
| .XX: ± 0.15 | .X° : ± 2.0° | DR:Chen Quan Long | DATE:20/12/23 |
| .XXX: ± 0.01 | .XX° : ± 1.0° | CHKD:Wu Hui | DATE:20/12/23 |
| DRAWING NO: | | APPD:Ren An De | DATE:20/12/23 |
| | | SCALE: N/A | PAGE: 1/1 |
| | | UNITS: mm | REV.: A |

X-ON Electronics

Largest Supplier of Electrical and Electronic Components

Click to view similar products for [Headers & Wire Housings](#) category:

Click to view products by [DLL](#) manufacturer:

Other Similar products are found below :

[0015917161](#) [0022155065](#) [57102-F02-18ULF](#) [58102-G61-06LF](#) [582553-1](#) [01.001.5753.1](#) [0050291907](#) [02.125.8002.8](#) [609-3404](#) [61062-3](#)
[CSU011177004](#) [622-0430](#) [622-3653LF](#) [63453-116](#) [636-1030](#) [636-1427](#) [636-3427](#) [636-4007](#) [641938-9](#) [65495-038](#) [65692-001LF](#) [65781-018](#)
[65781-047](#) [65817-010LF](#) [65817-015LF](#) [67095-007LF](#) [67601157](#) [68631-112](#) [68645-018](#) [699319-000](#) [70.362.1628.0](#) [70-4210](#) [70-4226B](#) [70-](#)
[4853B](#) [71.350.2428.0](#) [733-134](#) [733-162](#) [MHR-64-VUAL](#) [80.063.4001.1](#) [800-90-001-10-001000](#) [801-43-002-10-013000](#) [801-43-006-10-](#)
[002000](#) [803-43-024-10-001000](#) [803-93-012-10-001000](#) [8-1437020-4](#) [819-22-004-30-001101](#) [820-22-006-30-001101](#) [820-22-008-30-001101](#)
[821-22-002-10-001101](#) [821-22-003-10-002101](#)