

## 技术特性/Specifications:

额定电压 Rated voltage: 100V AC, DC  
额定电流 Rated current: 3A AC, DC  
接触电阻 Contact resistance: 20m $\Omega$  max  
绝缘电阻 Insulation resistance: 1000M $\Omega$  min  
耐压 Withstand voltage: 1000V AC/minute  
环境温度 Ambient temperature: -40 $^{\circ}$ C~+105 $^{\circ}$ C  
适用线规 Wire range: AWG#26~#22

| REV. | REVISION DESCRIPTION | DATE   | APPD  |
|------|----------------------|--------|-------|
| B    | 外形尺寸作调整              | 22.7.4 | Wuhui |

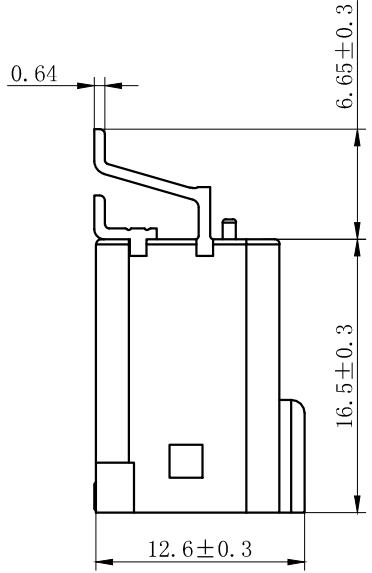
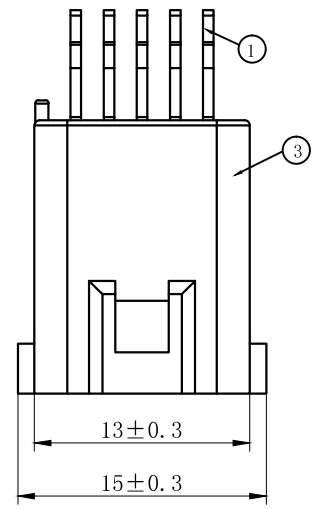
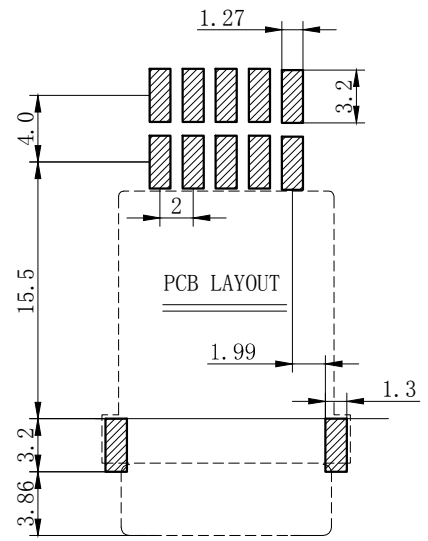
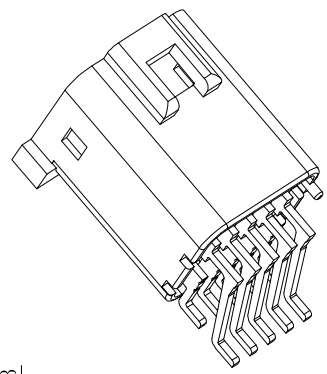
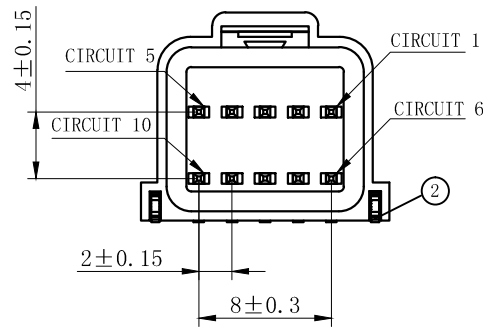

**NOTES**

Available in 10 Circuits.  
 Mates with DL20023-Y Series Housing.  
 Material : LCP UL94V-0.  
 Pin Material : Brass.Tin-plated .  
 Green Material RoHS Compliant.

|    |    |     |     |    |         |
|----|----|-----|-----|----|---------|
| 3  | ③  | 基座  | LCP | 1  | UL94V-0 |
| 2  | ②  | 焊片  | 黄铜  | 2  | 镀锡      |
| 1  | ①  | 接触件 | 黄铜  | N* | 镀锡      |
| 序号 | 图号 | 名称  | 材料  | 数量 | 附件      |

| GENERAL TOLERANCES (UNLESS SPECIFIED)   |               | ZHE JIANG DELI CONNECTORS CO ., LTD          |               |
|---|---------------|--|---------------|
| .X: ± 0.30                              | X° : ± 3.0°   | PRODUCT NAME: DL20023-10AWB                  |               |
| .XX: ± 0.15                             | .X° : ± 2.0°  | TITLE: 2.00 mm Pitch Wire To Board SMT Wafer |               |
| .XXX: ± 0.01                            | .XX° : ± 1.0° | DR:Chen Quan Long                            | DATE:22.05.19 |
| FINISH: _____                           |               | CHKD: Wu Hui                                 | DATE:22.05.19 |
| DRAWING NO: GC-DL20023-XXWB-XXX-XX-X-XX |               | APPD: Ren An De                              | DATE:22.05.19 |
|   |               | SCALE: N/A                                   | PAGE:1/1      |
|   |               | UNITS: mm                                    | REV. : B      |

| REV. | REVISION DESCRIPTION | DATE | APPD |
|------|----------------------|------|------|
|      |                      |      |      |

### DL20023-2AS

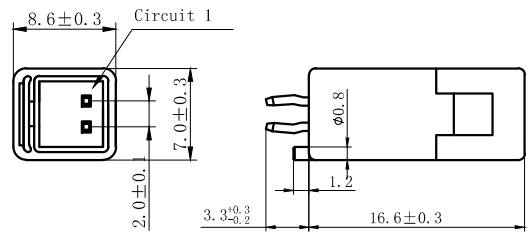

### DL20023-6AS

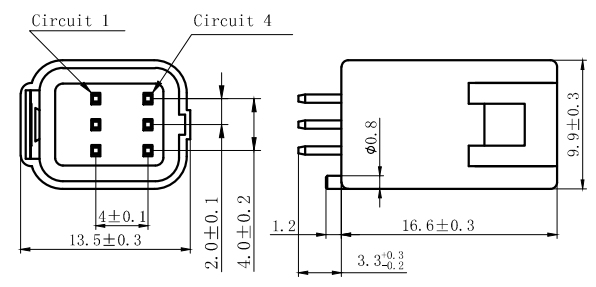

### DL20023-3AS

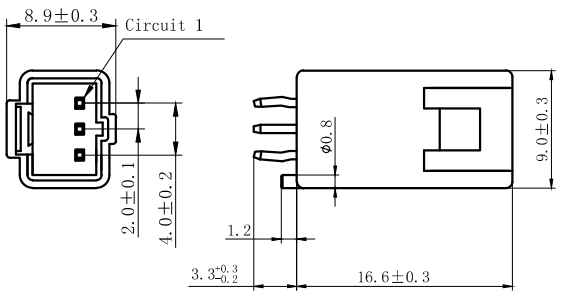

### DL20023-8AS

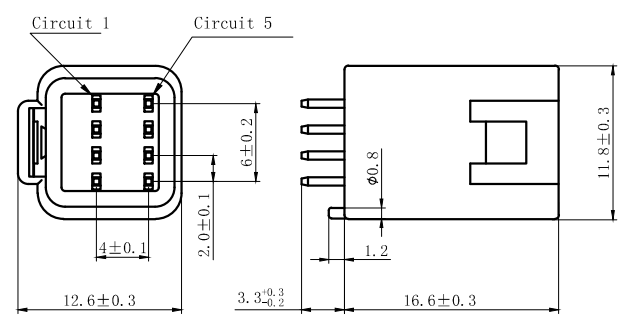

### DL20023-4AS

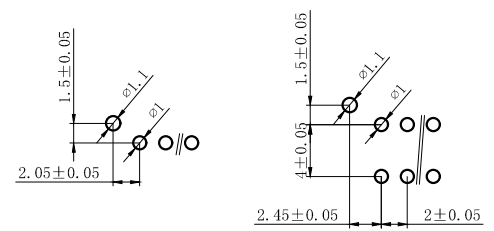
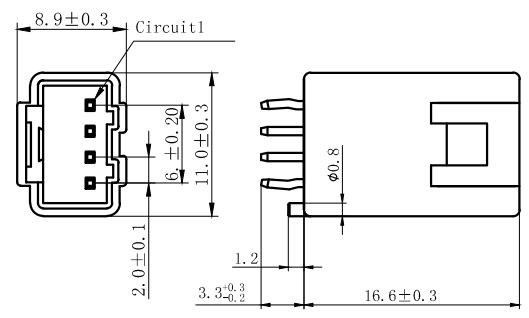

P. C. B LAYOUT

NORES:

1. Rated voltage: 100V AC/DC
2. Rated current: 3A AC/DC
3. Contact resistance:  $\leq 15 \text{ m}\Omega$
4. Insulation resistance:  $\geq 1000 \text{ M}\Omega$
5. Withstand voltage: 1000V AC/minute
6. Ambient temperature:  $-40^\circ\text{C} \sim 105^\circ\text{C}$
7. Materials: PBT UL94V-0(2).
8. Matched RoHS criteria

| GENERAL TOLERANCES (UNLESS SPECIFIED) |                       | ZHE JIANG DELI CONNECTORS CO., LTD |  |
|---------------------------------------|-----------------------|------------------------------------|--|
| .X: $\pm 0.30$                        | X°: $\pm 3.0^\circ$   | PRODUCT NAME:<br>DL20023-AS        | TITLE: 2.0 mm Pitch<br>Wire To Board Wafer |
| .XX: $\pm 0.15$                       | .X°: $\pm 2.0^\circ$  | DR: Yuan Jun Rong                  | DATE: 20.10.12                             |
| .XXX: $\pm 0.01$                      | .XX°: $\pm 1.0^\circ$ | CHKD: Wu Hui                       | DATE: 20.10.12                             |
| DRAWING NO:                           |                       | APPD: Ren An De                    | DATE: 20.10.12                             |
| FINISH:                               |                       | SCALE: N/A                         | PAGE: 1/2                                  |
|                                       |                       | UNITS: mm                          | REV.: A                                    |

| REV. | REVISION DESCRIPTION | DATE | APPD |
|------|----------------------|------|------|
|      |                      |      |      |

DL20023-10AS

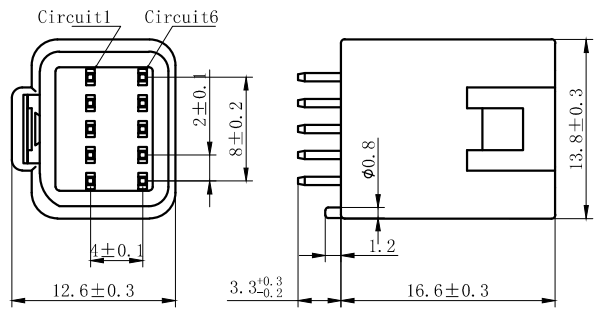

DL20023-12AS

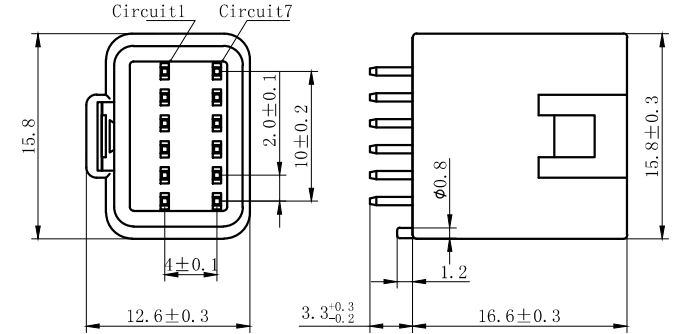

- NORES:
1. Rated voltage: 100V AC/DC
  2. Rated current: 3A AC/DC
  3. Contact resistance:  $\leq 15 \text{ m}\Omega$
  4. Insulation resistance:  $\geq 1000 \text{ M}\Omega$
  5. Withstand voltage: 1000V AC/minute
  6. Ambient temperature:  $-40^{\circ}\text{C} \sim 105^{\circ}\text{C}$
  7. Materials: PBT UL94V-0(2).
  8. Matched RoHS criteria

DL20023-14AS

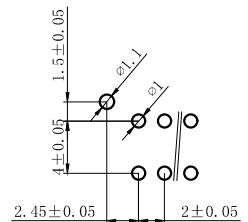
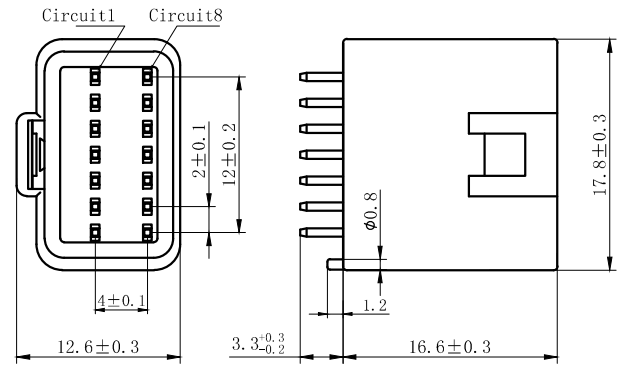

P. C. B LAYOUT

| GENERAL TOLERANCES (UNLESS SPECIFIED) |                         | ZHE JIANG DELI CONNECTORS CO., LTD |  |
|---------------------------------------|-------------------------|------------------------------------|--|
| .X: $\pm 0.30$                        | X°: $\pm 3.0^{\circ}$   | PRODUCT NAME:<br>DL20023-AS        | TITLE: 2.0 mm Pitch<br>Wire To Board Wafer |
| .XX: $\pm 0.15$                       | .X°: $\pm 2.0^{\circ}$  | DR: Yuan Jun Rong                  | DATE: 20.10.12                             |
| .XXX: $\pm 0.01$                      | .XX°: $\pm 1.0^{\circ}$ | CHKD: Wu Hui                       | DATE: 20.10.12                             |
| DRAWING NO:                           |                         | APPD: Ren An De                    | DATE: 20.10.12                             |
|                                       |                         | SCALE: N/A                         | PAGE: 2/2                                  |
|                                       |                         | UNITS: mm                          | REV.: A                                    |

|      |                      |      |      |
|------|----------------------|------|------|
| REV. | REVISION DESCRIPTION | DATE | APPD |
|------|----------------------|------|------|

### DL20023-2AWS

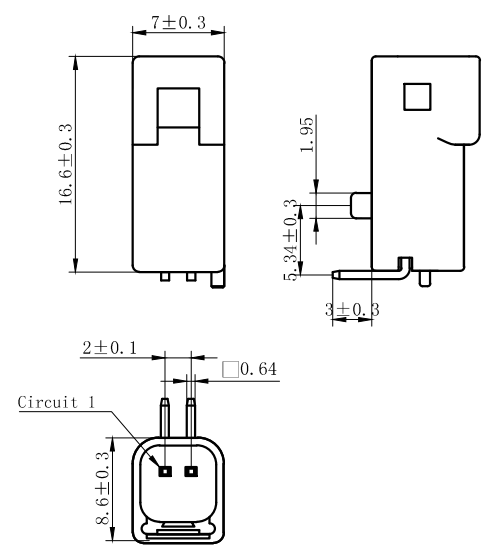

### DL20023-3AWS

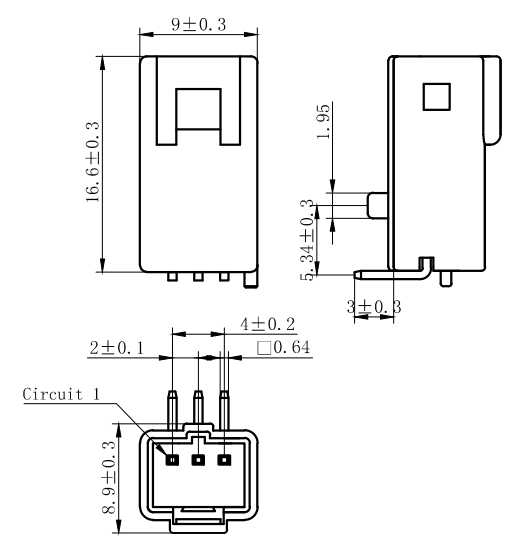

#### NORES:

1. Rated voltage: 100V AC/DC
2. Rated current: 3A AC/DC
3. Contact resistance:  $\leq 15$  m $\Omega$
4. Insulation resistance:  $\geq 1000$  M $\Omega$
5. Withstand voltage: 1000V AC/minute
6. Ambient temperature:  $-40^{\circ}\text{C} \sim 105^{\circ}\text{C}$
7. Materials: PBT UL94V-0(2).
8. Matched RoHS criteria

### DL20023-4AWS

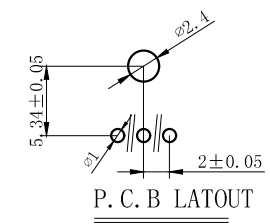
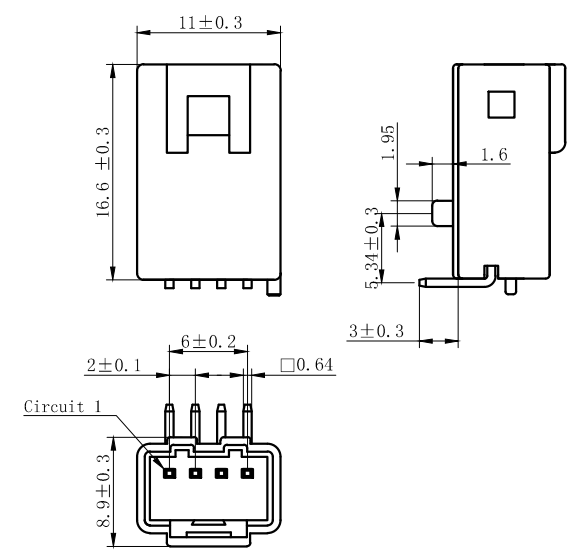

|                                       |                         |                                    |  |
|---------------------------------------|-------------------------|------------------------------------|--|
| GENERAL TOLERANCES (UNLESS SPECIFIED) |                         | ZHE JIANG DELI CONNECTORS CO., LTD |  |
| .X: $\pm 0.30$                        | X°: $\pm 3.0^{\circ}$   | PRODUCT NAME:<br>DL20023-AWS       | TITLE: 2.0 mm Pitch<br>Wire To Board Wafer |
| .XX: $\pm 0.15$                       | .X°: $\pm 2.0^{\circ}$  | DR: Yuan Jun Rong                  | DATE: 20.10.12                             |
| .XXX: $\pm 0.01$                      | .XX°: $\pm 1.0^{\circ}$ | CHKD: Wu Hui                       | DATE: 20.10.12                             |
| DRAWING NO:                           |                         | APPD: Ren An De                    | DATE: 20.10.12                             |
|                                       |                         | PART NO:                           | SCALE: N/A                                 |
|                                       |                         | UNITS: mm                          | PAGE: 1/3                                  |
|                                       |                         | REV.: A                            |  |

### DL20023-6AWS

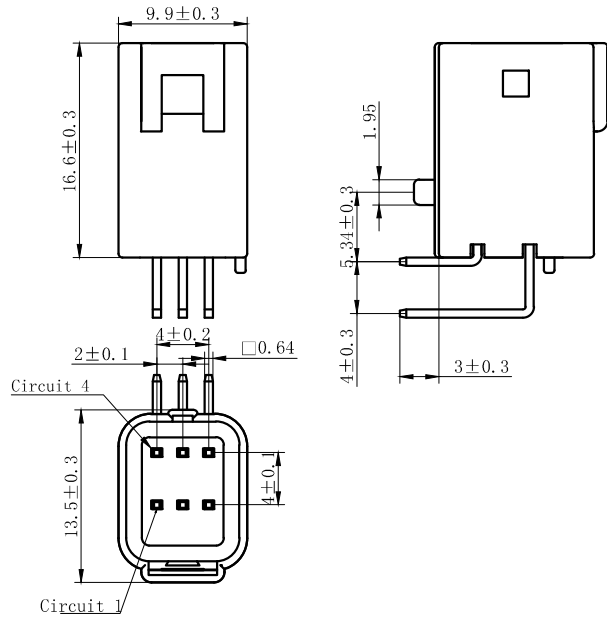

### DL20023-8AWS

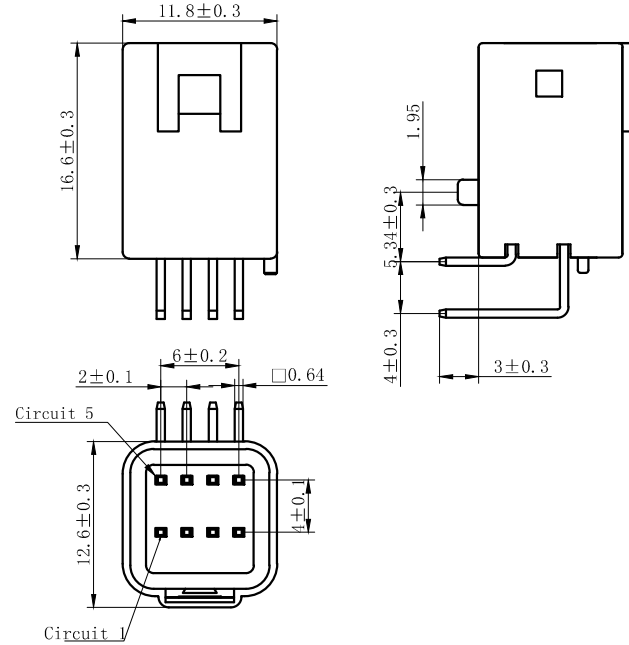

### DL20023-10AWS

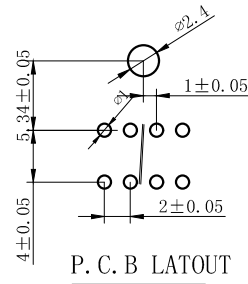
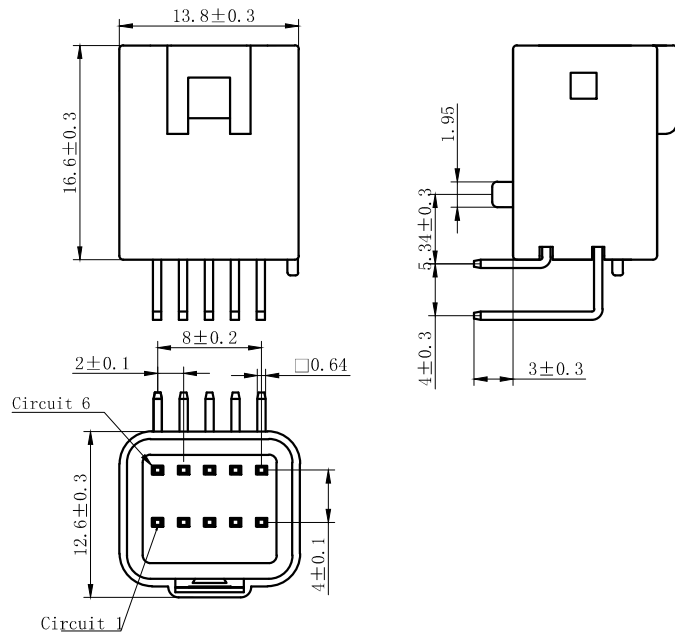

#### NORES:

1. Rated voltage: 100V AC/DC
2. Rated current: 3A AC/DC
3. Contact resistance:  $\leq 15 \text{ m}\Omega$
4. Insulation resistance:  $\geq 1000 \text{ M}\Omega$
5. Withstand voltage: 1000V AC/minute
6. Ambient temperature:  $-40^\circ\text{C} \sim 105^\circ\text{C}$
7. Materials: PBT UL94V-0(2).
8. Matched RoHS criteria

| GENERAL TOLERANCES (UNLESS SPECIFIED) |                       | ZHE JIANG DELI CONNECTORS CO., LTD |  |
|---------------------------------------|-----------------------|------------------------------------|--|
| .X: $\pm 0.30$                        | X°: $\pm 3.0^\circ$   | PRODUCT NAME:<br>DL20023-AWS       | TITLE: 2.0 mm Pitch<br>Wire To Board Wafer |
| .XX: $\pm 0.15$                       | .X°: $\pm 2.0^\circ$  | DR: Yuan Jun Rong                  | DATE: 20.10.12                             |
| .XXX: $\pm 0.01$                      | .XX°: $\pm 1.0^\circ$ | FINISH:                            | PART NO:                                   |
| DRAWING NO:                           |                       | CHKD: Wu Hui                       | DATE: 20.10.12                             |
|                                       |                       | APPD: Ren An De                    | DATE: 20.10.12                             |
|                                       |                       | UNITS: mm                          | SCALE: N/A                                 |
|                                       |                       |                                    | PAGE: 2/3                                  |
|                                       |                       |                                    | REV.: A                                    |

| REV. | REVISION DESCRIPTION | DATE | APPD |
|------|----------------------|------|------|
|      |                      |      |      |

### DL20023-12AWS

### DL20023-14AWS

**NORES:**

1. Rated voltage: 100V AC.DC
2. Rated current: 3A AC DC
3. Contact resistance:  $\leq 15 \text{ m}\Omega$
4. Insulation resistance:  $\geq 1000 \text{ M}\Omega$
5. Withstand voltage: 1000V AC/minute
6. Ambient temperature:  $-40^{\circ}\text{C} \sim 105^{\circ}\text{C}$
7. Materials: PBT UL94V-0(2).
8. Matched RoHS criteria

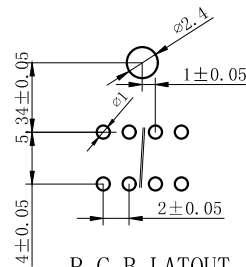
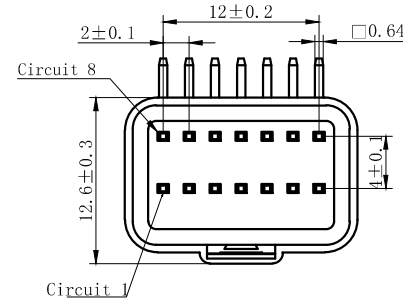
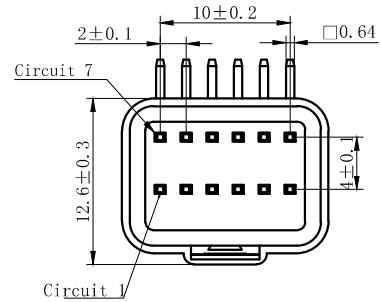
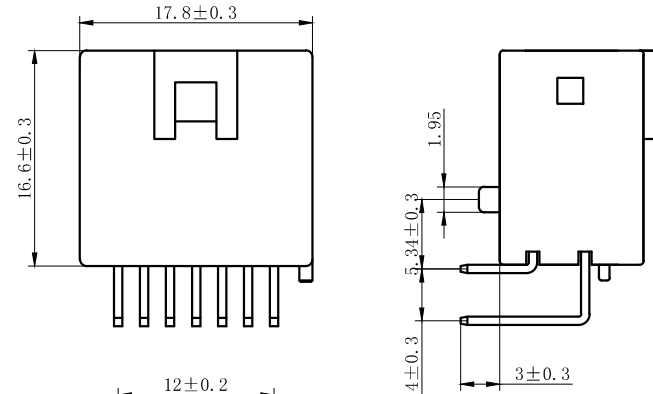
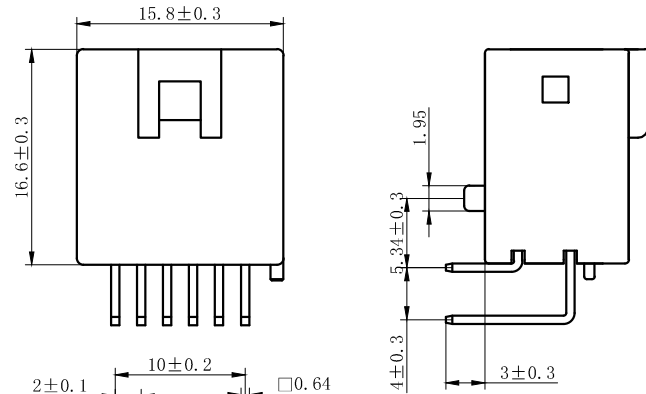

P. C. B LATOUT

| GENERAL TOLERANCES (UNLESS SPECIFIED) |                         | ZHE JIANG DELI CONNECTORS CO., LTD |  |
|---------------------------------------|-------------------------|------------------------------------|--|
| .X: $\pm 0.30$                        | X°: $\pm 3.0^{\circ}$   | PRODUCT NAME:<br>DL20023-AWS       | TITLE: 2.0 mm Pitch<br>Wire To Board Wafer |
| .XX: $\pm 0.15$                       | .X°: $\pm 2.0^{\circ}$  | DR: Yuan Jun Rong                  | DATE: 20.10.12                             |
| .XXX: $\pm 0.01$                      | .XX°: $\pm 1.0^{\circ}$ | CHKD: Wu Hui                       | DATE: 20.10.12                             |
| DRAWING NO:                           |                         | APPD: Ren An De                    | DATE: 20.10.12                             |
|                                       |                         | PART NO:                           | SCALE: N/A                                 |
|                                       |                         |                                    | PAGE: 3/3                                  |
|                                       |                         | UNITS: mm                          | REV.: A                                    |

DL20023-2Y

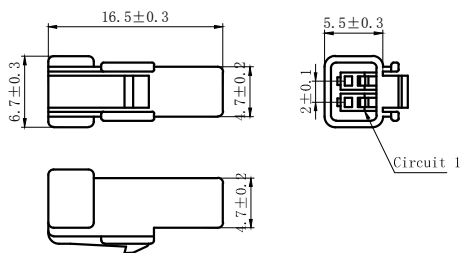

DL20023-3Y

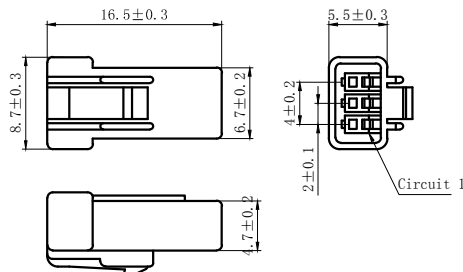

DL20023-8Y

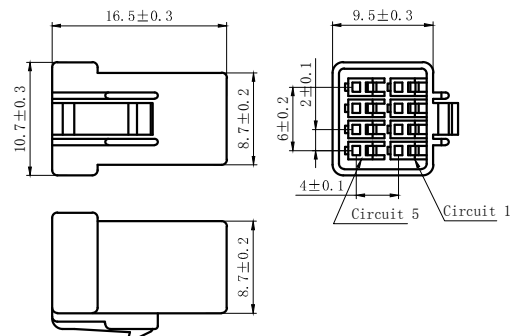

| REV. | REVISION DESCRIPTION | DATE | APPD |
|------|----------------------|------|------|
|      |                      |      |      |

DL20023-4Y

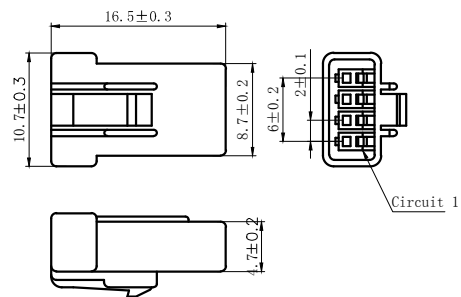

DL20023-6Y

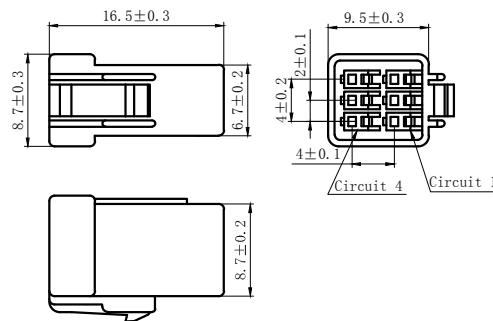

NOTES

Available in 02.03.04.06.08 Circuits.  
 Mates with DL20023 Series Housing.  
 Material : PBT UL94V-0(2).  
 Accepts DL20023-T Crimp Terminal.  
 Green Material RoHS Compliant.

|                                       |             |                                   |                                |
|---------------------------------------|-------------|-----------------------------------|--------------------------------|
| GENERAL TOLERANCES (UNLESS SPECIFIED) |             | ZHE JIANG DELI CONNECTORS CO.,LTD |                                |
| . X: ± 0.30                           | X° ± 3.0°   | PRODUCT NAME:<br>DL20023-Y        | TITLE:<br>2.0 mm Pitch Housing |
| . XX: ± 0.15                          | . X° ± 2.0° | DR:Chen Quan Long                 | DATE:21/08/01                  |
| . XXX: ± 0.01                         | . X° ± 1.0° | CHKD:Wu Hui                       | DATE:21/08/01                  |
| FINISH:                               |             | APPD:Ren An De                    | DATE:21/08/01                  |
| DRAWING NO:                           |             |                                   |                                |

A

B

C

D

E

F

A

B

C

D

E

F

1 2 3 4 5 6 7 8

1 2 3 4 5 6 7 8



| REV. | REVISION DESCRIPTION | DATE | APPD |
|------|----------------------|------|------|
|      |                      |      |      |

DL20023-10Y

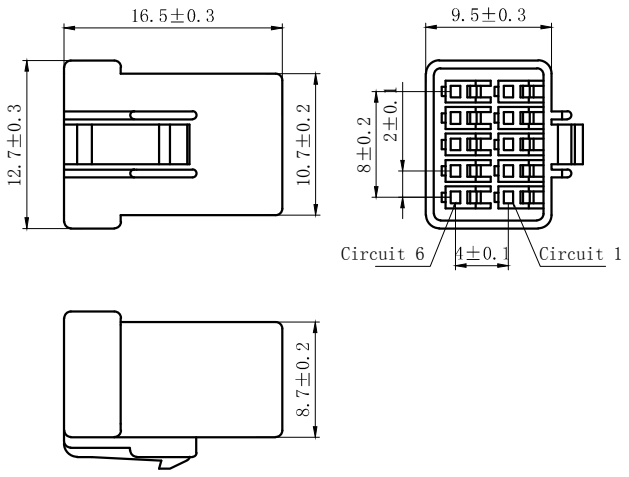

DL20023-12Y

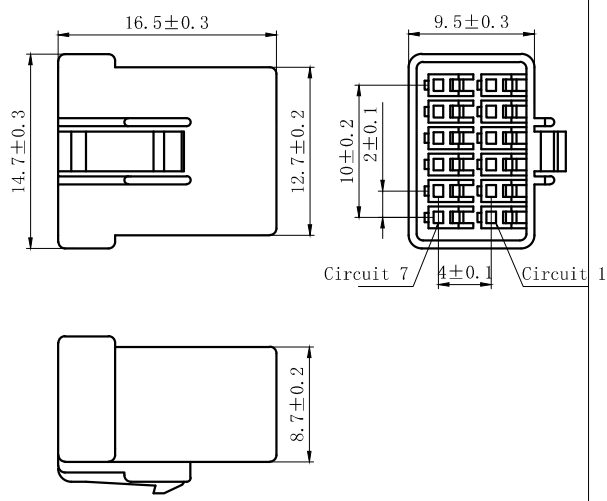

DL20023-14Y

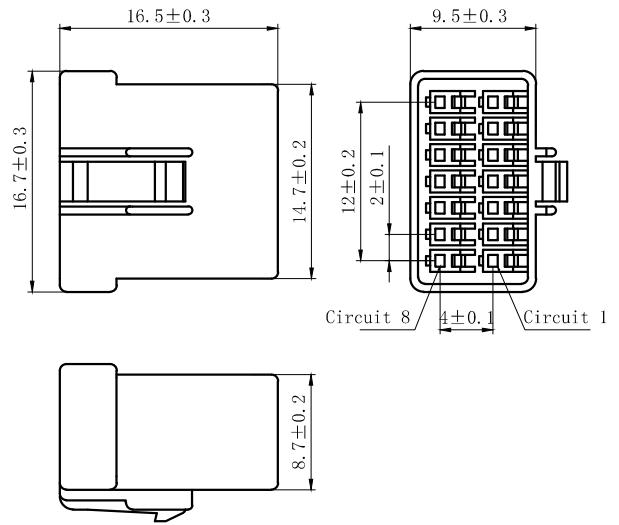

NOTES

Available in 10.12.14 Circuits.  
Mates with DL20023 Series Housing.  
Material : PBT UL94V-0(2).  
Accepts DL20023-T Crimp Terminal.  
Green Material RoHS Compliant.

|                                       |            |                                    |                      |
|---------------------------------------|------------|------------------------------------|----------------------|
| GENERAL TOLERANCES (UNLESS SPECIFIED) |            | ZHE JIANG DELI CONNECTORS CO., LTD |                      |
| .X: ± 0.30                            | X° ± 3.0°  | PRODUCT NAME:                      | TITLE:               |
| .XX: ± 0.15                           | .X° ± 2.0° | DL20023-Y                          | 2.0 mm Pitch Housing |
| .XXX: ± 0.01                          | .X° ± 1.0° | DR:Chen Quan Long                  | DATE:21/08/01        |
| FINISH:                               |            | CHKD:Wu Hui                        | DATE:21/08/01        |
| DRAWING NO:                           |            | APPD:Ren An De                     | DATE:21/08/01        |
|                                       |            |                                    | PART NO:             |
|                                       |            |                                    | SCALE: N/A           |
|                                       |            |                                    | PAGE:2/2             |
|                                       |            |                                    | UNITS: mm            |
|                                       |            |                                    | REV.: A              |

DL20023-2Y-0.75

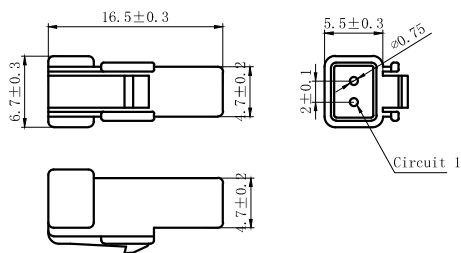

DL20023-3Y-0.75

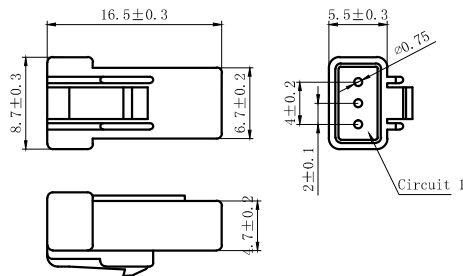

DL20023-8Y-0.75

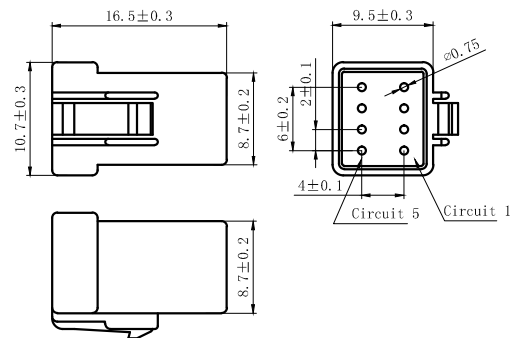

| REV. | REVISION DESCRIPTION | DATE | APPD |
|------|----------------------|------|------|
|      |                      |      |      |

DL20023-4Y-0.75

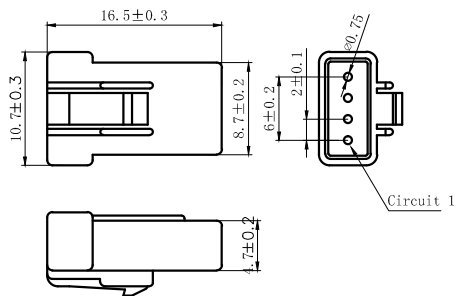

DL20023-6Y-0.75

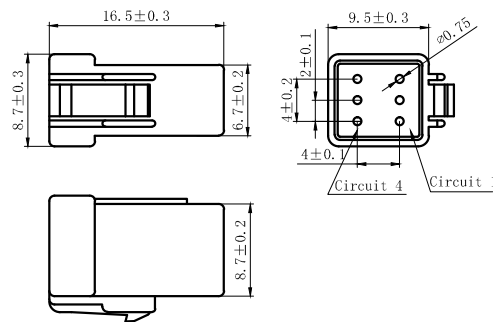

NOTES

Available in 02.03.04.06.08 Circuits.  
 Mates with DL20023 Series Housing.  
 Material : PBT UL94V-0(2).  
 Accepts DL20023-T Crimp Terminal.  
 Green Material RoHS Compliant.

|                                       |            |                                   |                                |
|---------------------------------------|------------|-----------------------------------|--------------------------------|
| GENERAL TOLERANCES (UNLESS SPECIFIED) |            | ZHE JIANG DELI CONNECTORS CO.,LTD |                                |
| .X: ± 0.30                            | X° ± 3.0°  | PRODUCT NAME:<br>DL20023-Y-0.75   | TITLE:<br>2.0 mm Pitch Housing |
| .XX: ± 0.15                           | .X° ± 2.0° | DR:Chen Quan Long                 | DATE:21/08/01                  |
| .XXX: ± 0.01                          | .X° ± 1.0° | CHKD:Wu Hui                       | DATE:21/08/01                  |
| FINISH:                               |            | APPD:Ren An De                    | DATE:21/08/01                  |
| DRAWING NO:                           |            |                                   |                                |

|            |          |
|------------|----------|
| PART NO:   |          |
| SCALE: N/A | PAGE:1/2 |
| UNITS: mm  | REV.: A  |

| REV. | REVISION DESCRIPTION | DATE | APPD |
|------|----------------------|------|------|
|      |                      |      |      |

DL20023-10R-0.75

DL20023-12R-0.75

DL20023-14R-0.75

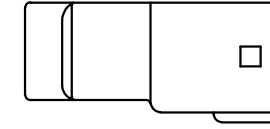
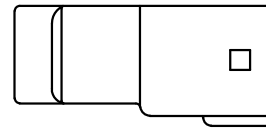
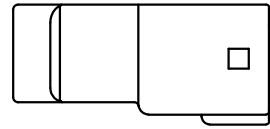
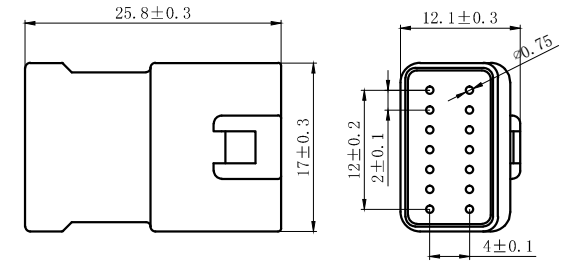
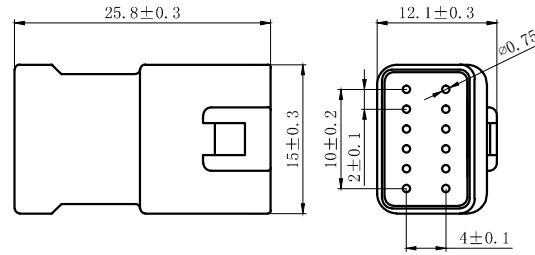
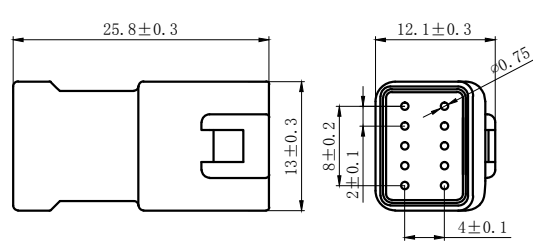

## NOTES

- Available in 10.12.14 Circuits.
- Mates with DL20023-Y Series Housing.
- Material : PBT UL94V-0(2).
- Accepts DL20023-RT Crimp Terminal.
- Green Material RoHS Compliant.

|                                       |               |                                    |   |
|---------------------------------------|---------------|------------------------------------|---|
| GENERAL TOLERANCES (UNLESS SPECIFIED) |               | ZHE JIANG DELI CONNECTORS CO., LTD |   |
| .X: ± 0.30                            | X° : ± 3.0°   | PRODUCT NAME:                      | TITLE:  |
| .XX: ± 0.15                           | .X° : ± 2.0°  | DL20023-R-0.75                     | 2.0 mm Pitch<br>Wire To Wire Receptacle Housing |
| .XXX: ± 0.01                          | .XX° : ± 1.0° | DR:Chen Quan Long                  | DATE:21/08/01                                   |
| FINISH:                               |               | CHKD:Wu Hui                        | DATE:21/08/01                                   |
| DRAWING NO:                           |               | APPD:Ren An De                     | DATE:21/08/01                                   |
|                                       |               |                                    | PART NO:  |
|                                       |               |                                    | SCALE: N/A                                      |
|                                       |               |                                    | PAGE:2/2  |
|                                       |               |                                    | UNITS: mm                                       |
|                                       |               |                                    | REV. : A  |

| REV. | REVISION DESCRIPTION | DATE | APPD |
|------|----------------------|------|------|
|      |                      |      |      |

DL20023-2R

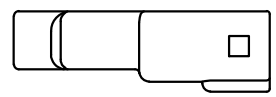
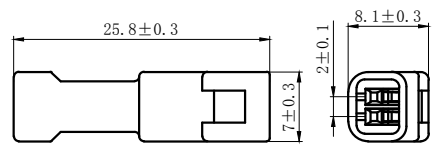

DL20023-3R

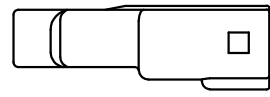
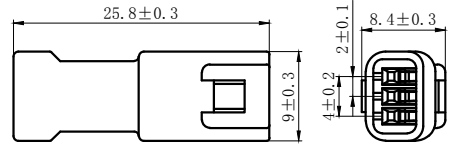

DL20023-8R

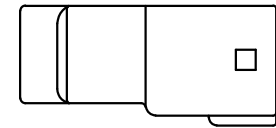
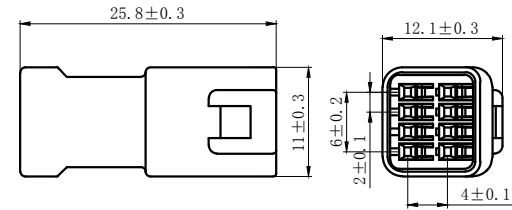

DL20023-4R

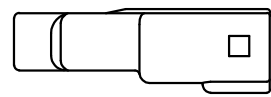
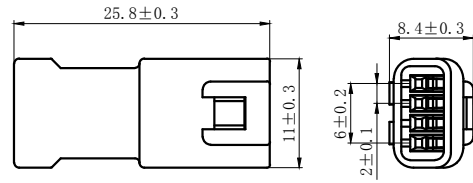

DL20023-6R

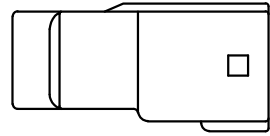
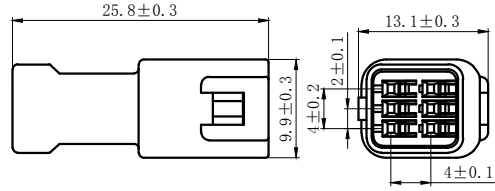

NOTES

Available in 02.03.04.06.08 Circuits.  
 Mates with DL20023-Y Series Housing.  
 Material : PBT UL94V-0(2).  
 Accepts DL20023-RT Crimp Terminal.  
 Green Material RoHS Compliant.

|                                       |               |                                    |   |
|---------------------------------------|---------------|------------------------------------|---|
| GENERAL TOLERANCES (UNLESS SPECIFIED) |               | ZHE JIANG DELI CONNECTORS CO., LTD |   |
| .X: ± 0.30                            | X° : ± 3.0°   | PRODUCT NAME:                      | TITLE:  |
| .XX: ± 0.15                           | .X° : ± 2.0°  | DL20023-R                          | 2.0 mm Pitch<br>Wire To Wire Receptacle Housing |
| .XXX: ± 0.01                          | .XX° : ± 1.0° | DR:Chen Quan Long                  | DATE:21/08/01                                   |
| FINISH:                               |               | CHKD:Wu Hui                        | DATE:21/08/01                                   |
| DRAWING NO:                           |               | APPD:Ren An De                     | DATE:21/08/01                                   |
|                                       |               | SCALE: N/A                         | PAGE:1/2  |
|                                       |               | UNITS: mm                          | REV.: A   |

| REV. | REVISION DESCRIPTION | DATE | APPD |
|------|----------------------|------|------|
|      |                      |      |      |

DL20023-10R

DL20023-12R

DL20023-14R

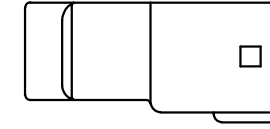
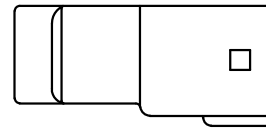
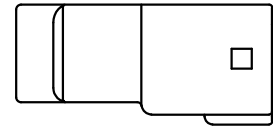
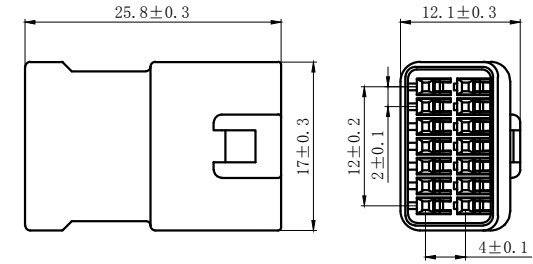
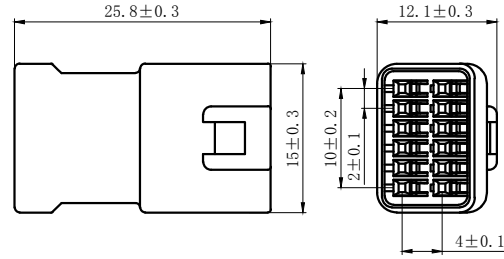
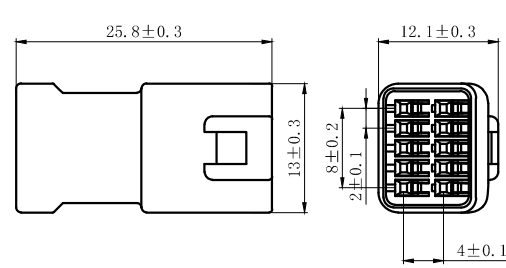

### NOTES

- Available in 10.12.14 Circuits.
- Mates with DL20023-Y Series Housing.
- Material : PBT UL94V-0(2).
- Accepts DL20023-RT Crimp Terminal.
- Green Material RoHS Compliant.

|                                       |               |                                    |   |
|---------------------------------------|---------------|------------------------------------|---|
| GENERAL TOLERANCES (UNLESS SPECIFIED) |               | ZHE JIANG DELI CONNECTORS CO., LTD |   |
| .X: ± 0.30                            | X° : ± 3.0°   | PRODUCT NAME:<br>DL20023-R         | TITLE:<br>2.0 mm Pitch<br>Wire To Wire Receptacle Housing |
| .XX: ± 0.15                           | .X° : ± 2.0°  | DR:Chen Quan Long                  | DATE:21/08/01   |
| .XXX: ± 0.01                          | .XX° : ± 1.0° | CHKD:Wu Hui                        | DATE:21/08/01   |
| FINISH:<br>_____                      |               | APPD:Ren An De                     | DATE:21/08/01   |
| DRAWING NO:                           |               | UNITS: mm                          | REV. : A  |

A

B

C

D

E

F

A

B

C

D

E

F

1

2

3

4

5

6

7

8

| REV. | REVISION DESCRIPTION | DATE | APPD |
|------|----------------------|------|------|
|      |                      |      |      |

DL20023-2R-0.75

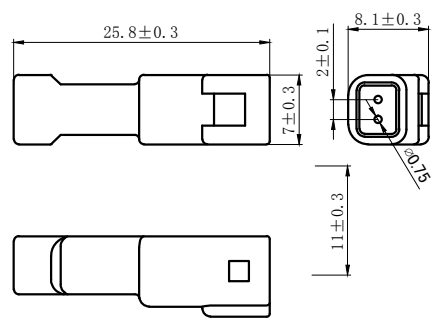

DL20023-3R-0.75

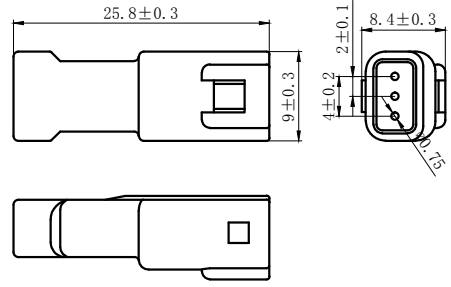

DL20023-8R-0.75

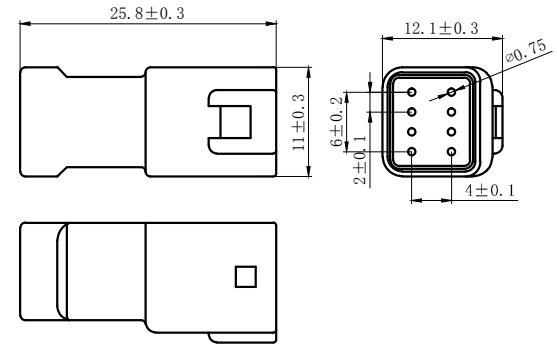

DL20023-4R-0.75

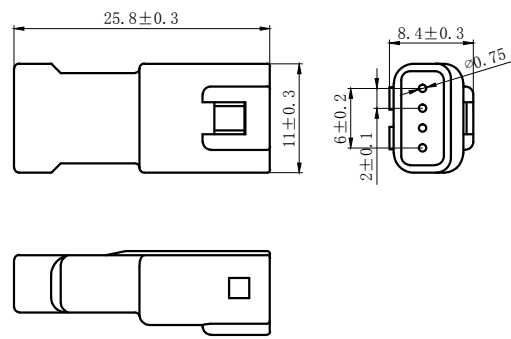

DL20023-6R-0.75

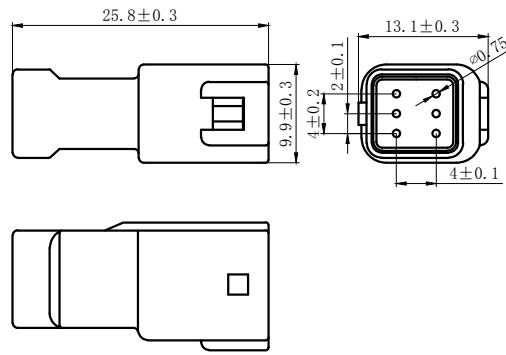

### NOTES

Available in 02.03.04.06.08 Circuits.  
Mates with DL20023-Y Series Housing.  
Material : PBT UL94V-0(2).  
Accepts DL20023-RT Crimp Terminal.  
Green Material RoHS Compliant.

|                                       |              |                                    |   |
|---------------------------------------|--------------|------------------------------------|---|
| GENERAL TOLERANCES (UNLESS SPECIFIED) |              | ZHE JIANG DELI CONNECTORS CO., LTD |   |
| .X: ± 0.30                            | X°: ± 3.0°   | PRODUCT NAME:<br>DL20023-R-0.75    | TITLE:<br>2.0 mm Pitch<br>Wire To Wire Receptacle Housing |
| .XX: ± 0.15                           | .X°: ± 2.0°  | DR:Chen Quan Long                  | DATE:21/08/01   |
| .XXX: ± 0.01                          | .XX°: ± 1.0° | CHKD:Wu Hui                        | DATE:21/08/01   |
| FINISH:                               |              | APPD:Ren An De                     | DATE:21/08/01   |
| DRAWING NO:                           |              |                                    |   |

A  
B  
C  
D  
E  
F

A  
B  
C  
D  
E  
F

1 2 3 4 5 6 7 8

DL20023-10Y-0.75

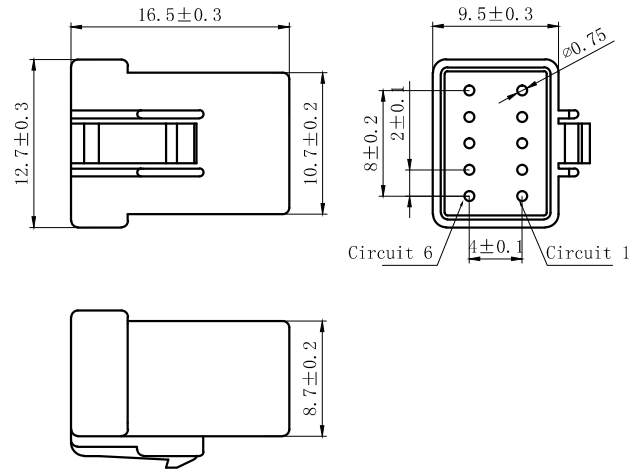

DL20023-12Y-0.75

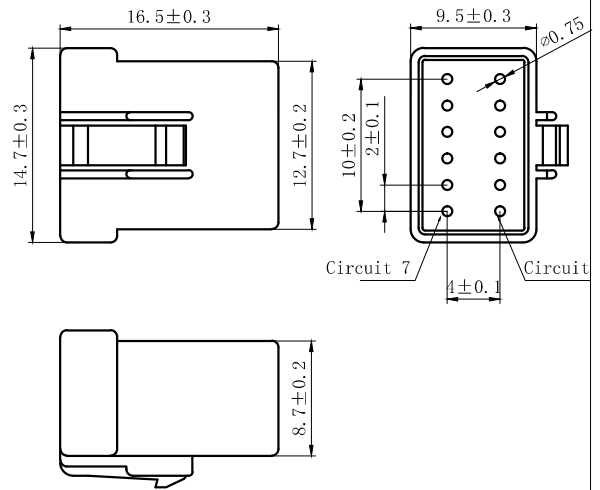

DL20023-14Y-0.75

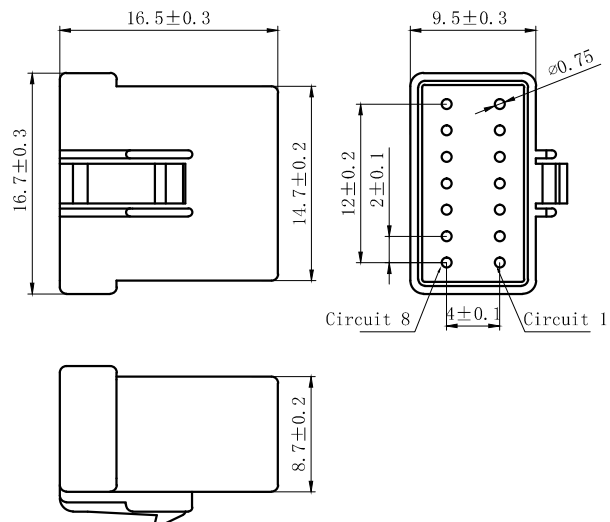

| REV. | REVISION DESCRIPTION | DATE | APPD |
|------|----------------------|------|------|
|      |                      |      |      |

NOTES

Available in 10.12.14 Circuits.  
 Mates with DL20023 Series Housing.  
 Material : PBT UL94V-0(2).  
 Accepts DL20023-T Crimp Terminal.  
 Green Material RoHS Compliant.

|  |            |                                   |                                |
|--|------------|-----------------------------------|--------------------------------|
| GENERAL TOLERANCES<br>(UNLESS SPECIFIED) |            | ZHE JIANG DELI CONNECTORS CO.,LTD |                                |
| .X: ± 0.30                               | X° ± 3.0°  | PRODUCT NAME:<br>DL20023-Y-0.75   | TITLE:<br>2.0 mm Pitch Housing |
| .XX: ± 0.15                              | .X° ± 2.0° | DR:Chen Quan Long                 | DATE:21/08/01                  |
| .XXX: ± 0.01                             | .X° ± 1.0° | CHKD:Wu Hui                       | DATE:21/08/01                  |
| FINISH:<br>_____                         |            | APPD:Ren An De                    | DATE:21/08/01                  |
| DRAWING NO:                              |            | SCALE: N/A                        | PAGE:2/2                       |
|  |            | UNITS: mm                         | REV. : A                       |

1 2 3 4 5 6 7 8

| REV. | REVISION DESCRIPTION | DATE | APPD |
|------|----------------------|------|------|
|      |                      |      |      |

A

A

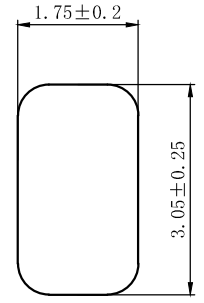
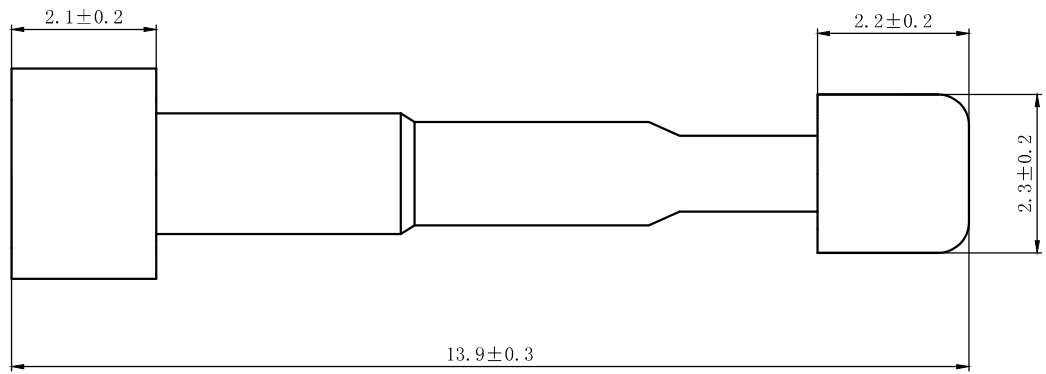

### NOTES

Mates with DL20023-Y or DL20023-R Series Housing.  
 Material : PBT UL94V-0 (2).  
 Green Material RoHS Compliant.

B

B

C

C

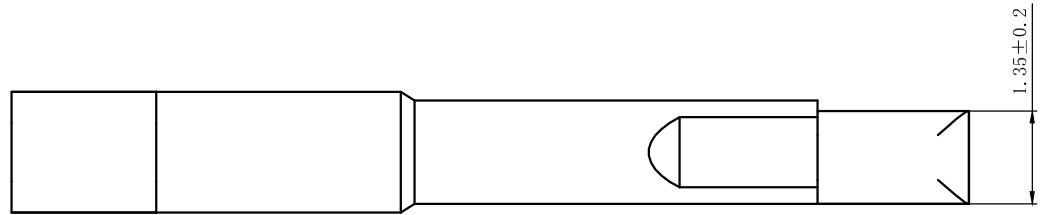

D

D

E

E

F

F

1 2 3 4 5 6 7 8

|                                       |               |                                    |   |
|---------------------------------------|---------------|------------------------------------|---|
| GENERAL TOLERANCES (UNLESS SPECIFIED) |               | ZHE JIANG DELI CONNECTORS CO., LTD |   |
| .X: ± 0.30                            | X° : ± 3.0°   | PRODUCT NAME:<br>DL20023-1E        | TITLE:<br>2.0 mm Pitch<br>Wire To Wire Receptacle Stopper |
| .XX: ± 0.15                           | .X° : ± 2.0°  | DR:KeXianQiang                     | DATE:17.10.12   |
| .XXX: ± 0.01                          | .XX° : ± 1.0° | CHKD: Liu Bing                     | DATE:17.10.12   |
| FINISH:<br>_____                      |               | APPD:Ren An De                     | DATE:17.10.12   |
| DRAWING NO:                           |               | SCALE: N/A                         | PAGE:1/1  |
|                                       |               | UNITS: mm                          | REV. : A  |



| REV. | REVISION DESCRIPTION | DATE | APPD |
|------|----------------------|------|------|
|      |                      |      |      |

### NOTES

Used in DL20023-Y Series Housing.  
 Accepts AWG #26~22 Wire Range.  
 0.13~ 0.33 mm<sup>2</sup> .  
 Insulation O. D. =1.4~1.7mm.  
 Material : Phosphor Bronze .  
 Finish: Tin plated.  
 Qty/Reel: 10,000 PCS.  
 Thickness: 0.25 mm.

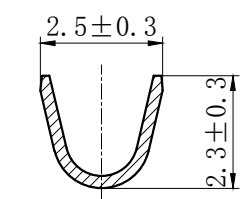
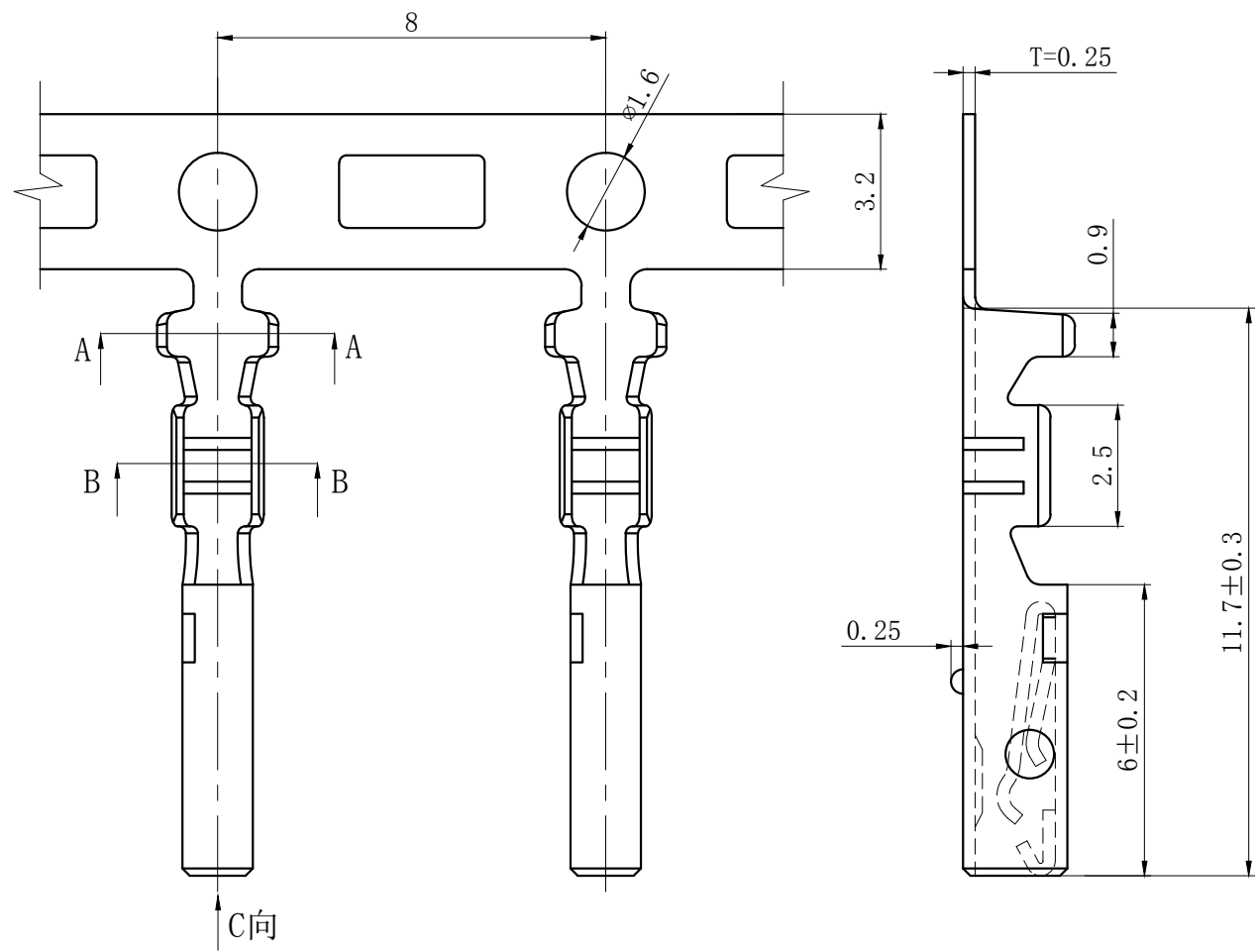

SECTION A-A

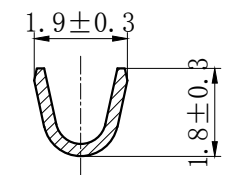

SECTION B-B

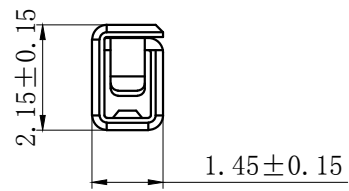

SECTION C-C

| GENERAL TOLERANCES<br>(UNLESS SPECIFIED) |               | ZHE JIANG DELI CONNECTORS CO., LTD |   |
|--|---------------|------------------------------------|---|
| .X: ± 0.25                               | X° : ± 3.0°   | PRODUCT NAME:<br>DL20023-T         | TITLE:<br>2.00 mm Pitch<br>Crimp Terminal |
| .XX: ± 0.15                              | .X° : ± 2.0°  | DR:Chen Quan Long                  | DATE:20/12/23                             |
| .XXX: ± 0.01                             | .XX° : ± 1.0° | CHKD:Wu Hui                        | DATE:20/12/23                             |
| DRAWING NO:                              |               | APPD:Ren An De                     | DATE:20/12/23                             |
|  |               | SCALE: N/A                         | PAGE: 1/1                                 |
|  |               | UNITS: mm                          | REV.: A                                   |

| REV. | REVISION DESCRIPTION | DATE | APPD |
|------|----------------------|------|------|
|      |                      |      |      |
|      |                      |      |      |

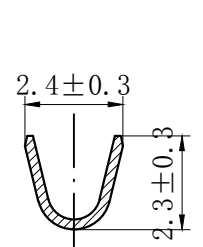
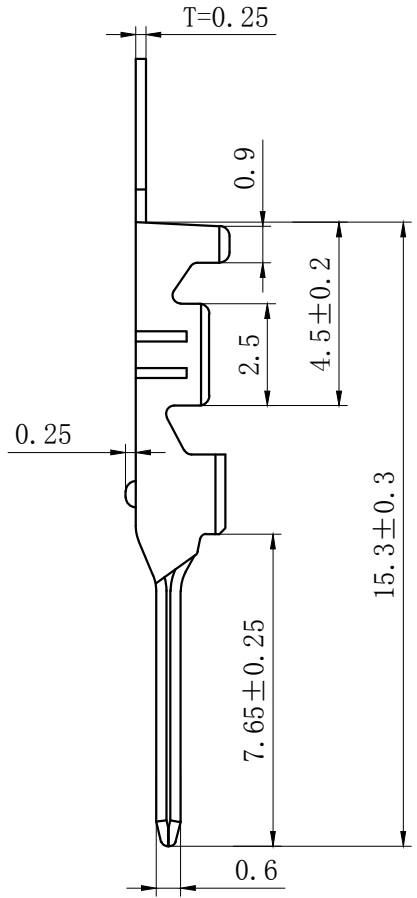
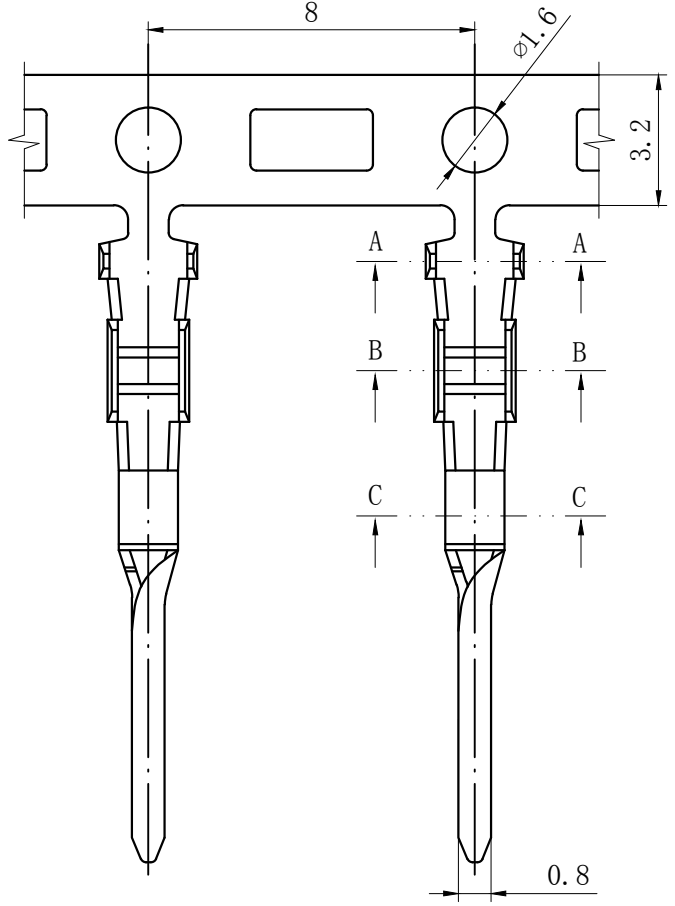

SECTION A-A

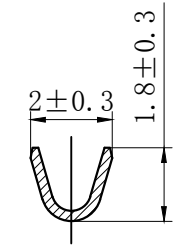

SECTION B-B

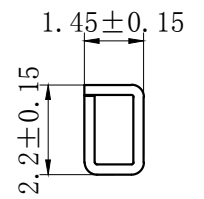

SECTION C-C

### NOTES

- Used in DL20023-R Series Housing.
- Accepts AWG #26~22 Wire Range.  
0.13~ 0.33 mm<sup>2</sup> .
- Insulation O.D.=1.4~1.7mm.
- Material : Phosphor Bronze .
- Finish: Tin plated.
- Qty/Reel: 10,000 PCS.
- Thickness: 0.25 mm.

| GENERAL TOLERANCES<br>(UNLESS SPECIFIED) |               | ZHE JIANG DELI CONNECTORS CO., LTD |  |
|--|---------------|------------------------------------|--|
| .X: ± 0.25                               | X° : ± 3.0°   | PRODUCT NAME:<br>DL20023-RT        | TITLE:<br>2.00 mm Pitch<br>Wire To Wire Crimp Terminal |
| .XX: ± 0.15                              | .X° : ± 2.0°  | DR:Chen Quan Long                  | DATE:20/12/23  |
| .XXX: ± 0.01                             | .XX° : ± 1.0° | CHKD:Wu Hui                        | DATE:20/12/23  |
| DRAWING NO:                              |               | APPD:Ren An De                     | DATE:20/12/23  |
|  |               | SCALE: N/A                         | PAGE: 1/1  |
|  |               | UNITS: mm                          | REV.: A  |

## X-ON Electronics

Largest Supplier of Electrical and Electronic Components

*Click to view similar products for [Headers & Wire Housings](#) category:*

*Click to view products by [DLL](#) manufacturer:*

Other Similar products are found below :

[0015917161](#) [0022155065](#) [57102-F02-18ULF](#) [58102-G61-06LF](#) [582553-1](#) [01.001.5753.1](#) [0050291907](#) [02.125.8002.8](#) [609-3404](#) [61062-3](#)  
[CSU011177004](#) [622-0430](#) [622-3653LF](#) [63453-116](#) [636-1030](#) [636-1427](#) [636-3427](#) [636-4007](#) [641938-9](#) [65495-038](#) [65692-001LF](#) [65781-018](#)  
[65781-047](#) [65817-010LF](#) [65817-015LF](#) [67095-007LF](#) [67601157](#) [68631-112](#) [68645-018](#) [699319-000](#) [70.362.1628.0](#) [70-4210](#) [70-4226B](#) [70-](#)  
[4853B](#) [71.350.2428.0](#) [733-134](#) [733-162](#) [760-3052](#) [MHR-64-VUAL](#) [80.063.4001.1](#) [800-90-001-10-001000](#) [801-43-002-10-013000](#)  
[801-43-006-10-002000](#) [803-43-024-10-001000](#) [803-93-012-10-001000](#) [8-1437020-4](#) [819-22-004-30-001101](#) [820-22-006-30-001101](#)  
[820-22-008-30-001101](#) [821-22-002-10-001101](#)