

技术特性/Specifications:

额定电压 Rated voltage: 100V AC, DC
额定电流 Rated current: 3A AC, DC
接触电阻 Contact resistance: 20m Ω max
绝缘电阻 Insulation resistance: 1000M Ω min
耐压 Withstand voltage: 1000V AC/minute
环境温度 Ambient temperature: -40 $^{\circ}$ C~+105 $^{\circ}$ C
适用线规 Wire range: AWG#26~#22

REV.	REVISION DESCRIPTION	DATE	APPD
B	外形尺寸作调整	22.7.4	Wuhui

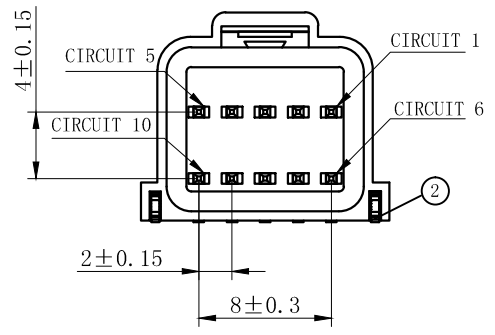

NOTES

Available in 10 Circuits.
 Mates with DL20023-Y Series Housing.
 Material : LCP UL94V-0.
 Pin Material : Brass.Tin-plated .
 Green Material RoHS Compliant.

3	③	基座	LCP	1	UL94V-0
2	②	焊片	黄铜	2	镀锡
1	①	接触件	黄铜	N*	镀锡
序号	图号	名称	材料	数量	附件

GENERAL TOLERANCES (UNLESS SPECIFIED)		ZHE JIANG DELI CONNECTORS CO ., LTD	
.X: ± 0.30	X° : ± 3.0°	PRODUCT NAME: DL20023-10AWB	
.XX: ± 0.15	.X° : ± 2.0°	TITLE: 2.00 mm Pitch Wire To Board SMT Wafer	
.XXX: ± 0.01	.XX° : ± 1.0°	DR:Chen Quan Long	DATE:22.05.19
FINISH: _____		CHKD: Wu Hui	DATE:22.05.19
DRAWING NO: GC-DL20023-XXWB-XXX-XX-X-XX		APPD: Ren An De	DATE:22.05.19
		SCALE: N/A	PAGE:1/1
		UNITS: mm	REV. : B

DL20023-2AS

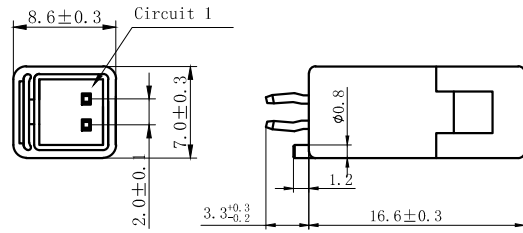

DL20023-6AS

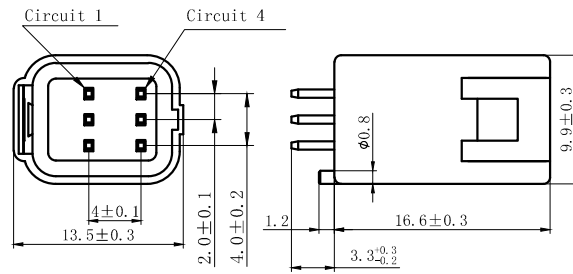

DL20023-3AS

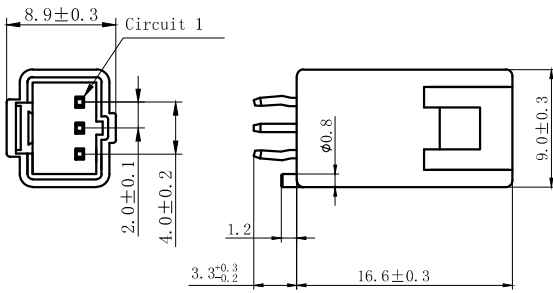

DL20023-8AS

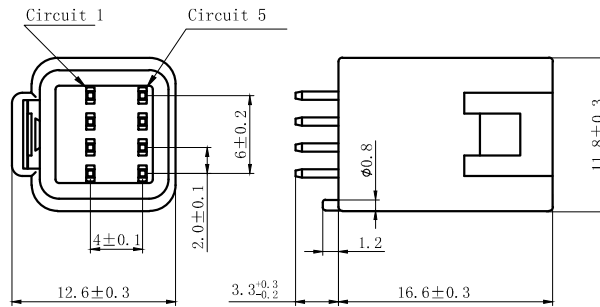

DL20023-4AS

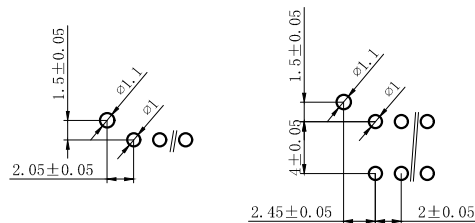
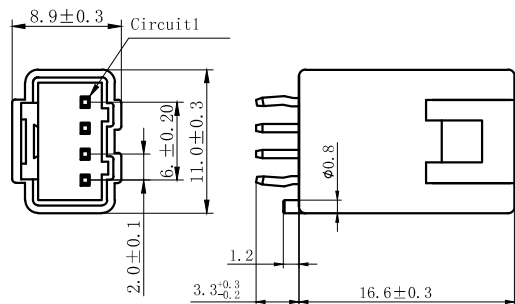

P. C. B LAYOUT

NORES:

1. Rated voltage: 100V AC/DC
2. Rated current: 3A AC/DC
3. Contact resistance: $\leq 15 \text{ m}\Omega$
4. Insulation resistance: $\geq 1000 \text{ M}\Omega$
5. Withstand voltage: 1000V AC/minute
6. Ambient temperature: $-40^\circ\text{C} \sim 105^\circ\text{C}$
7. Materials: PBT UL94V-0(2).
8. Matched RoHS criteria

GENERAL TOLERANCES (UNLESS SPECIFIED)		ZHE JIANG DELI CONNECTORS CO., LTD	
.X: ± 0.30	X°: $\pm 3.0^\circ$	PRODUCT NAME: DL20023-AS	TITLE: 2.0 mm Pitch Wire To Board Wafer
.XX: ± 0.15	.X°: $\pm 2.0^\circ$	DR: Yuan Jun Rong	DATE: 20.10.12
.XXX: ± 0.01	.XX°: $\pm 1.0^\circ$	DATE: 20.10.12	PART NO:
FINISH:		CHKD: Wu Hui	DATE: 20.10.12
DRAWING NO:		APPD: Ren An De	DATE: 20.10.12
		SCALE: N/A	PAGE: 1/2
		UNITS: mm	REV.: A

REV.	REVISION DESCRIPTION	DATE	APPD

DL20023-10AS

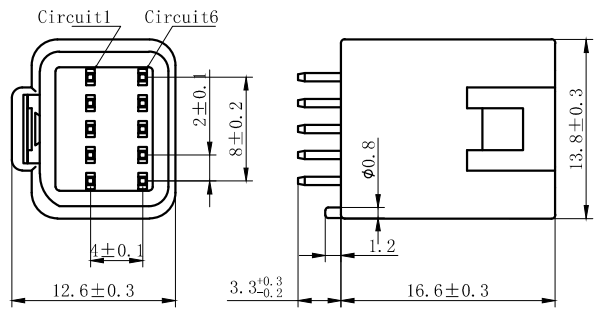

DL20023-12AS

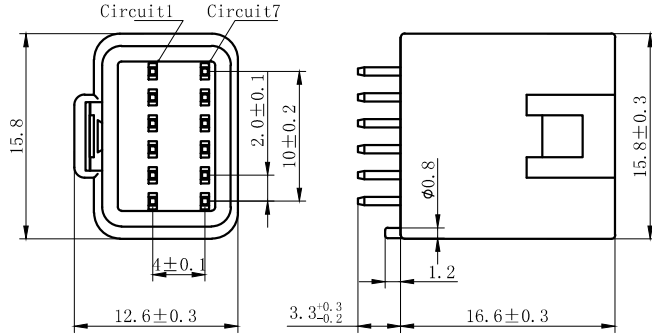

- NORES:
1. Rated voltage: 100V AC/DC
 2. Rated current: 3A AC/DC
 3. Contact resistance: ≤15 mΩ
 4. Insulation resistance: ≥1000MΩ
 5. Withstand voltage: 1000V AC/minute
 6. Ambient temperature: -40°C~105°C
 7. Materials: PBT UL94V-0(2).
 8. Matched RoHS criteria

DL20023-14AS

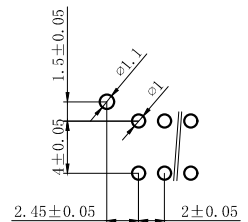
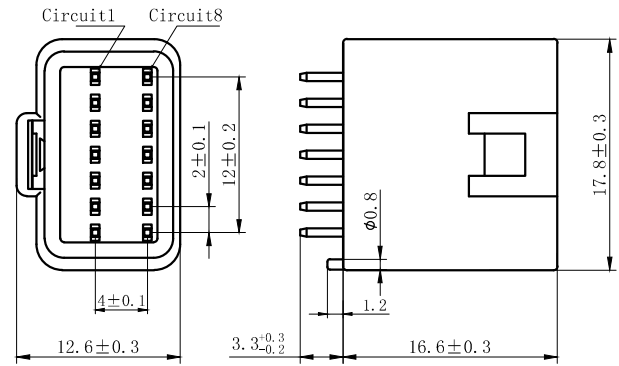

P. C. B LAYOUT

GENERAL TOLERANCES (UNLESS SPECIFIED)		ZHE JIANG DELI CONNECTORS CO., LTD	
.X: ± 0.30	X°: ± 3.0°	PRODUCT NAME:	TITLE: 2.0 mm Pitch Wire To Board Wafer
.XX: ± 0.15	.X°: ± 2.0°	DL20023-AS	
.XXX: ± 0.01	.XX°: ± 1.0°	DR: Yuan Jun Rong	DATE: 20.10.12
FINISH:		CHKD: Wu Hui	DATE: 20.10.12
DRAWING NO:		APPD: Ren An De	DATE: 20.10.12
			PART NO:
			SCALE: N/A
			PAGE: 2/2
			UNITS: mm
			REV.: A

DL20023-2AWS

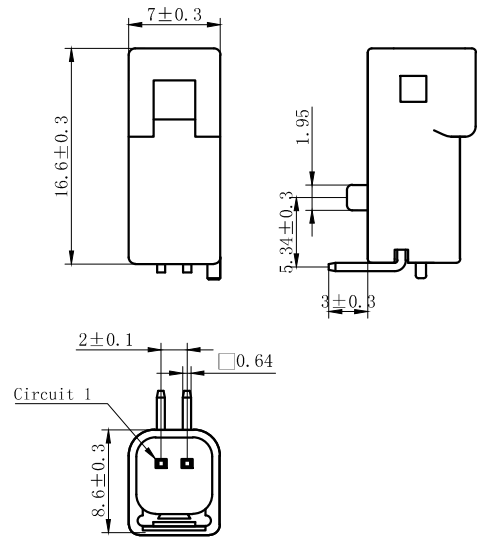

DL20023-3AWS

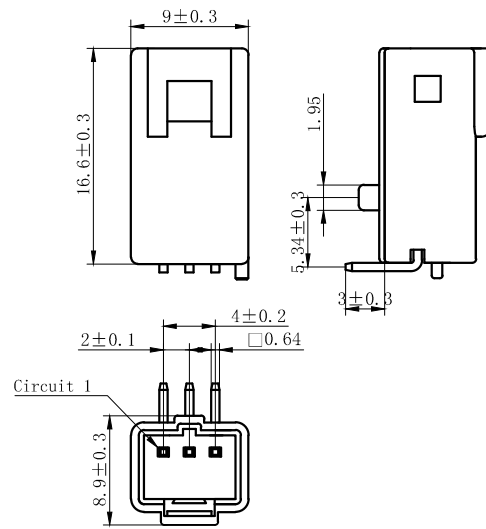

NORES:

1. Rated voltage: 100V AC.DC
2. Rated current: 3A AC DC
3. Contact resistance: $\leq 15 \text{ m}\Omega$
4. Insulation resistance: $\geq 1000 \text{ M}\Omega$
5. Withstand voltage: 1000V AC/minute
6. Ambient temprature: $-40^\circ\text{C} \sim 105^\circ\text{C}$
7. Materials: PBT UL94V-0(2).
8. Matched RoHS criteria

DL20023-4AWS

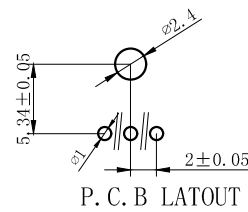
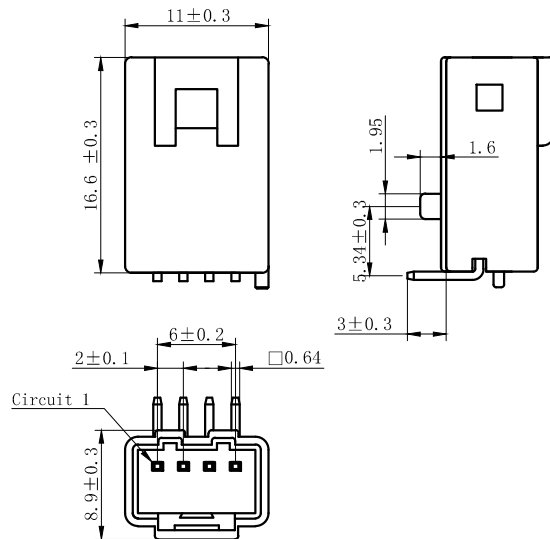

GENERAL TOLERANCES (UNLESS SPECIFIED)		ZHE JIANG DELI CONNECTORS CO., LTD	
.X: ± 0.30	X°: $\pm 3.0^\circ$	PRODUCT NAME: DL20023-AWS	TITLE: 2.0 mm Pitch Wire To Board Wafer
.XX: ± 0.15	.X°: $\pm 2.0^\circ$	DR: Yuan Jun Rong	DATE: 20.10.12
.XXX: ± 0.01	.XX°: $\pm 1.0^\circ$	CHKD: Wu Hui	DATE: 20.10.12
DRAWING NO:		APPD: Ren An De	DATE: 20.10.12
		PART NO:	SCALE: N/A
		UNITS: mm	PAGE: 1/3
		REV.: A	

REV.	REVISION DESCRIPTION	DATE	APPD

DL20023-6AWS

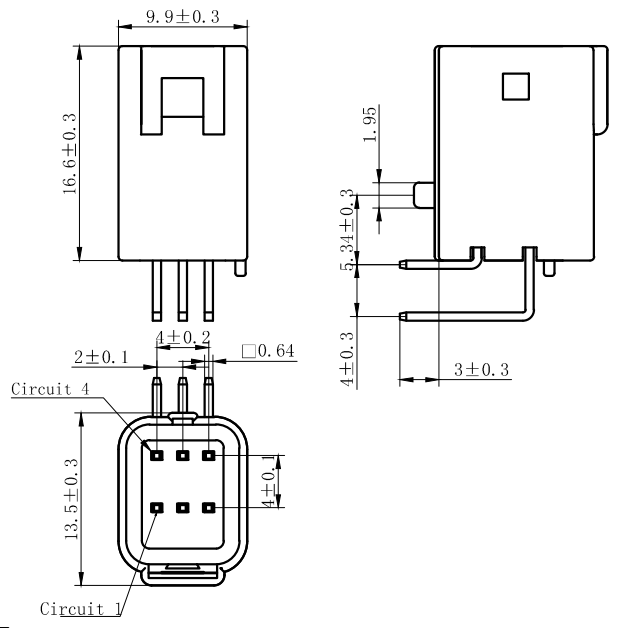

DL20023-8AWS

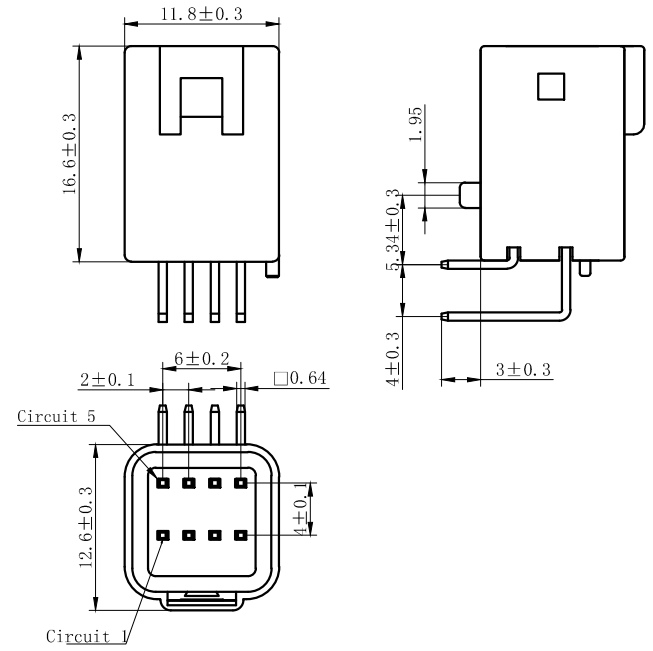

NORES:

1. Rated voltage: 100V AC/DC
2. Rated current: 3A AC/DC
3. Contact resistance: $\leq 15 \text{ m}\Omega$
4. Insulation resistance: $\geq 1000 \text{ M}\Omega$
5. Withstand voltage: 1000V AC/minute
6. Ambient temperature: $-40^\circ\text{C} \sim 105^\circ\text{C}$
7. Materials: PBT UL94V-0(2).
8. Matched RoHS criteria

DL20023-10AWS

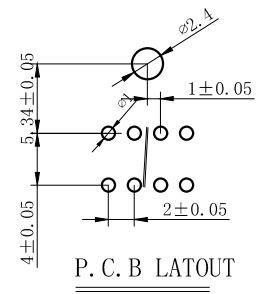
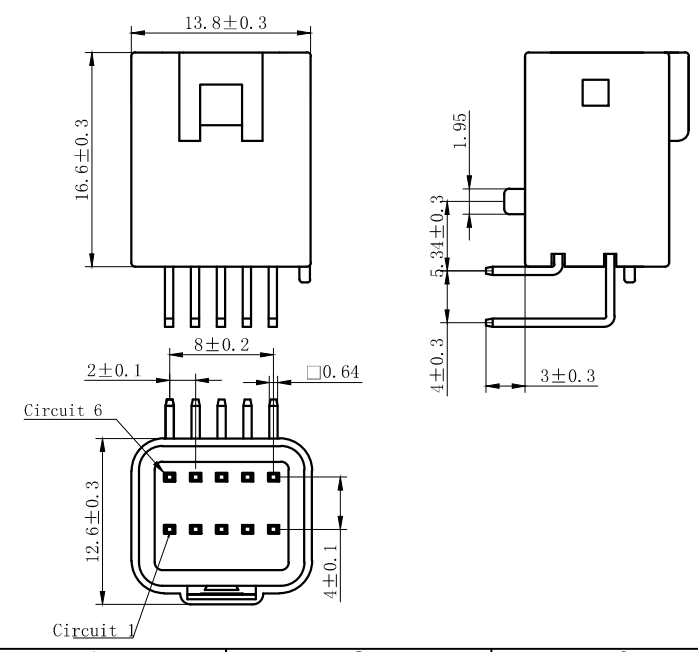

GENERAL TOLERANCES (UNLESS SPECIFIED)		ZHE JIANG DELI CONNECTORS CO., LTD			
.X: ± 0.30	X°: $\pm 3.0^\circ$	PRODUCT NAME: DL20023-AWS		TITLE: 2.0 mm Pitch Wire To Board Wafer	
.XX: ± 0.15	.X°: $\pm 2.0^\circ$	DR: Yuan Jun Rong	DATE: 20.10.12	PART NO:	
.XXX: ± 0.01	.XX°: $\pm 1.0^\circ$	FINISH: _____	CHKD: Wu Hui	DATE: 20.10.12	SCALE: N/A
DRAWING NO:		APPD: Ren An De	DATE: 20.10.12	UNITS: mm	PAGE: 2/3
				REV.: A	

DL20023-12AWS

DL20023-14AWS

NORES:

1. Rated voltage: 100V AC.DC
2. Rated current: 3A AC DC
3. Contact resistance: $\leq 15 \text{ m}\Omega$
4. Insulation resistance: $\geq 1000 \text{ M}\Omega$
5. Withstand voltage: 1000V AC/minute
6. Ambient temperature: $-40^{\circ}\text{C} \sim 105^{\circ}\text{C}$
7. Materials: PBT UL94V-0(2).
8. Matched RoHS criteria

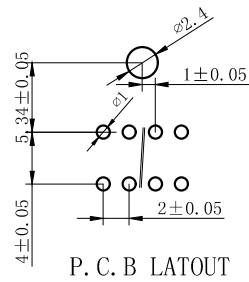
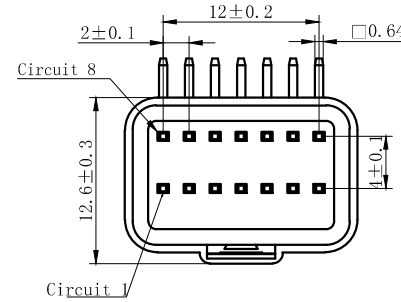
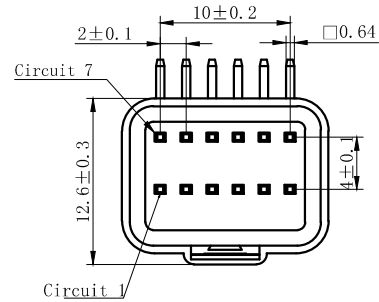
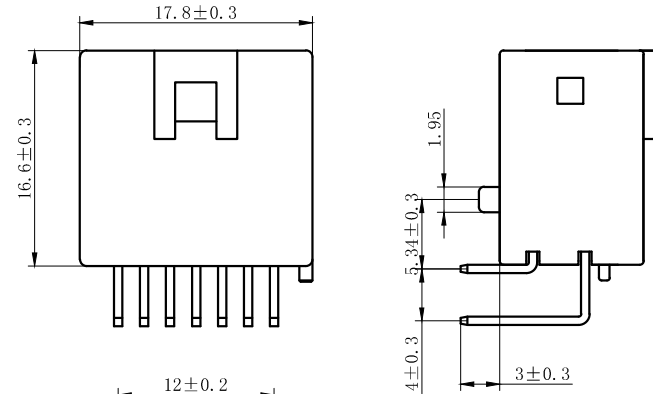
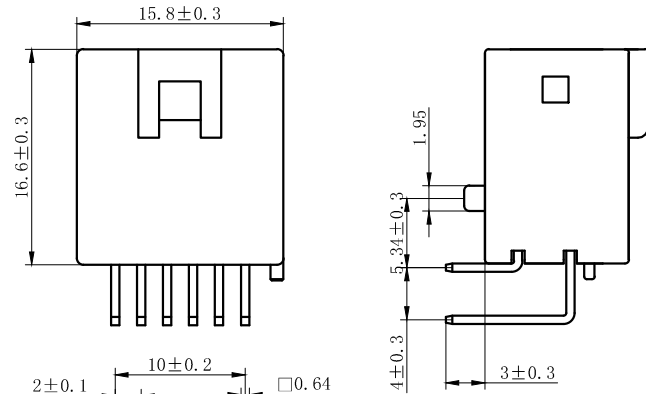

GENERAL TOLERANCES (UNLESS SPECIFIED)		ZHE JIANG DELI CONNECTORS CO., LTD	
.X: ± 0.30	X°: $\pm 3.0^{\circ}$	PRODUCT NAME: DL20023-AWS	TITLE: 2.0 mm Pitch Wire To Board Wafer
.XX: ± 0.15	.X°: $\pm 2.0^{\circ}$	DR: Yuan Jun Rong	DATE: 20.10.12
.XXX: ± 0.01	.XX°: $\pm 1.0^{\circ}$	CHKD: Wu Hui	DATE: 20.10.12
DRAWING NO:		APPD: Ren An De	DATE: 20.10.12
		PART NO:	SCALE: N/A
		UNITS: mm	PAGE: 3/3
		REV.: A	

DL20023-2Y

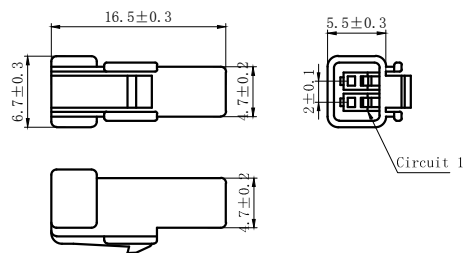

DL20023-3Y

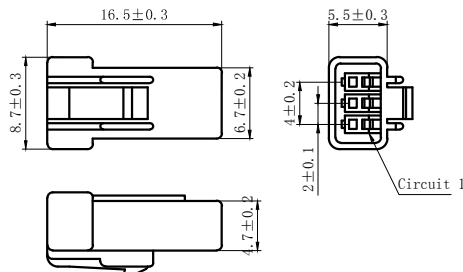

DL20023-8Y

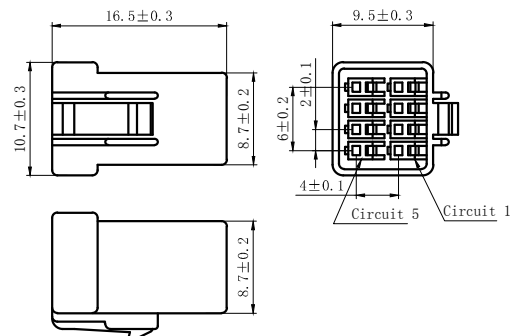

REV.	REVISION DESCRIPTION	DATE	APPD

DL20023-4Y

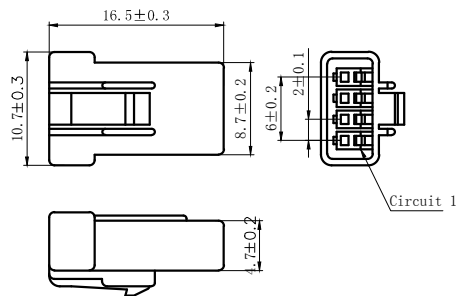

DL20023-6Y

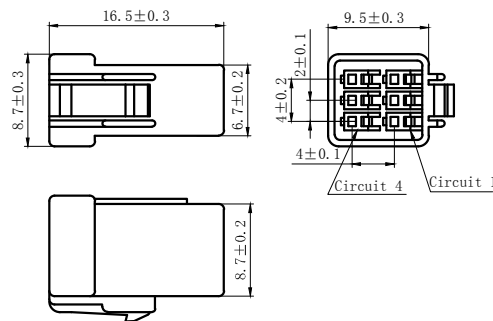

NOTES

Available in 02.03.04.06.08 Circuits.
 Mates with DL20023 Series Housing.
 Material : PBT UL94V-0(2).
 Accepts DL20023-T Crimp Terminal.
 Green Material RoHS Compliant.

GENERAL TOLERANCES (UNLESS SPECIFIED)		ZHE JIANG DELI CONNECTORS CO.,LTD	
. X: ± 0.30	X° ± 3.0°	PRODUCT NAME:	TITLE:
. XX: ± 0.15	. X° ± 2.0°	DL20023-Y	
. XXX: ± 0.01	. X° ± 1.0°	DR:Chen Quan Long	DATE:21/08/01
FINISH:		CHKD:Wu Hui	DATE:21/08/01
DRAWING NO:		APPD:Ren An De	DATE:21/08/01
		PART NO:	
		2.0 mm Pitch Housing	
		SCALE: N/A	PAGE:1/2
		UNITS: mm	REV.: A

REV.	REVISION DESCRIPTION	DATE	APPD

DL20023-10Y

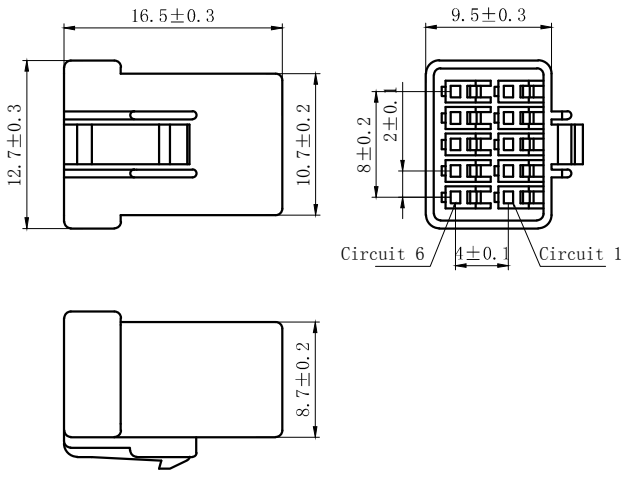

DL20023-12Y

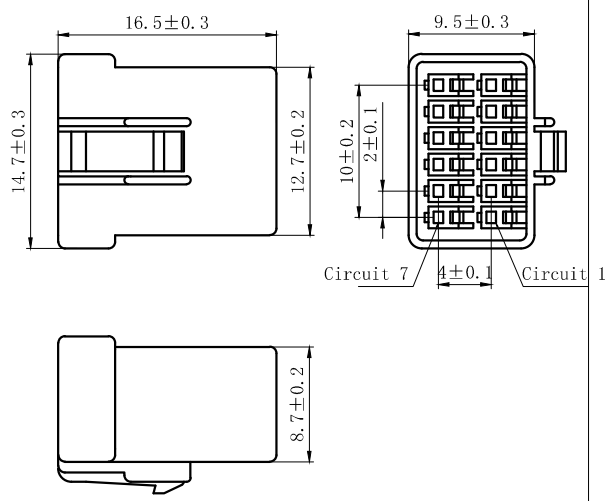

NOTES

Available in 10.12.14 Circuits.
 Mates with DL20023 Series Housing.
 Material : PBT UL94V-0(2).
 Accepts DL20023-T Crimp Terminal.
 Green Material RoHS Compliant.

DL20023-14Y

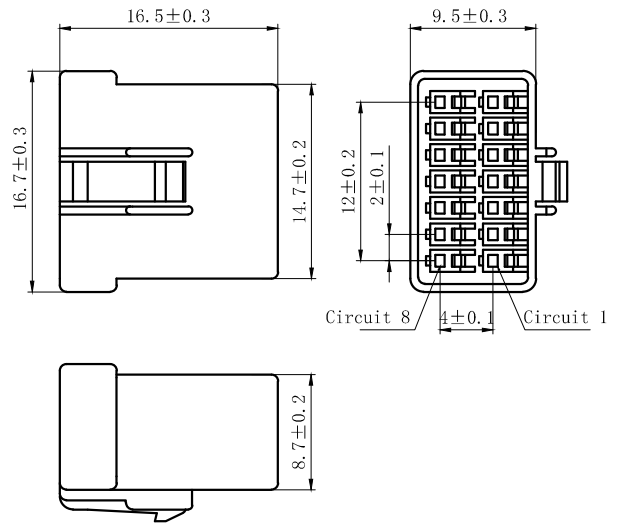

GENERAL TOLERANCES (UNLESS SPECIFIED)		ZHE JIANG DELI CONNECTORS CO., LTD	
.X: ± 0.30	X° ± 3.0°	PRODUCT NAME: DL20023-Y	TITLE: 2.0 mm Pitch Housing
.XX: ± 0.15	.X° ± 2.0°	DR: Chen Quan Long	DATE: 21/08/01
.XXX: ± 0.01	.X° ± 1.0°	CHKD: Wu Hui	DATE: 21/08/01
FINISH:		APPD: Ren An De	DATE: 21/08/01
DRAWING NO:		SCALE: N/A	PAGE: 2/2
		UNITS: mm	REV.: A

DL20023-2Y-0.75

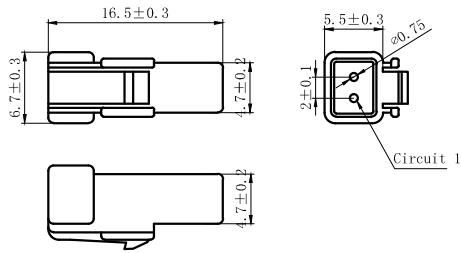

DL20023-3Y-0.75

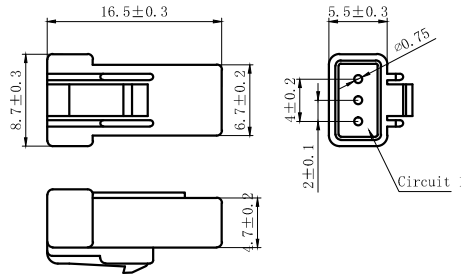

DL20023-8Y-0.75

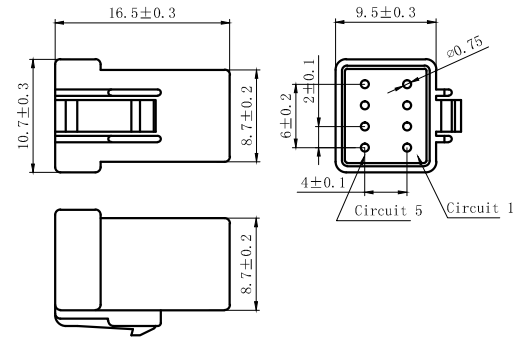

REV.	REVISION DESCRIPTION	DATE	APPD

DL20023-4Y-0.75

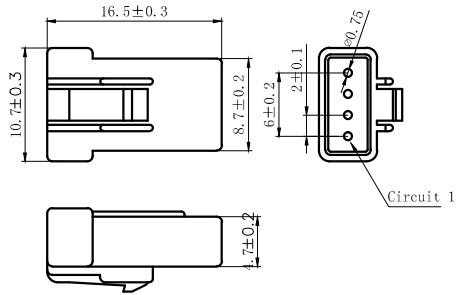

DL20023-6Y-0.75

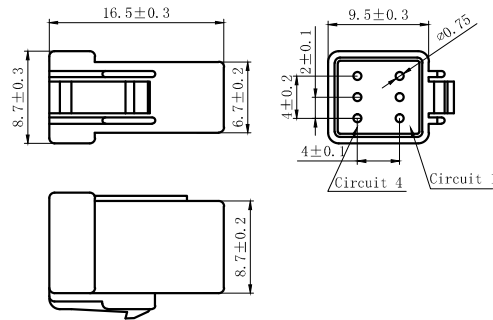

NOTES

Available in 02.03.04.06.08 Circuits.
 Mates with DL20023 Series Housing.
 Material : PBT UL94V-0(2).
 Accepts DL20023-T Crimp Terminal.
 Green Material RoHS Compliant.

GENERAL TOLERANCES (UNLESS SPECIFIED)		ZHE JIANG DELI CONNECTORS CO.,LTD	
.X: ± 0.30	X° ± 3.0°	PRODUCT NAME: DL20023-Y-0.75	TITLE: 2.0 mm Pitch Housing
.XX: ± 0.15	.X° ± 2.0°	DR:Chen Quan Long	DATE:21/08/01
.XXX: ± 0.01	.X° ± 1.0°	CHKD:Wu Hui	DATE:21/08/01
FINISH:		APPD:Ren An De	DATE:21/08/01
DRAWING NO:			

PART NO:	
SCALE: N/A	PAGE:1/2
UNITS: mm	REV.: A

REV.	REVISION DESCRIPTION	DATE	APPD

DL20023-10R-0.75

DL20023-12R-0.75

DL20023-14R-0.75

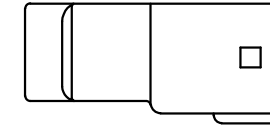
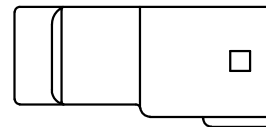
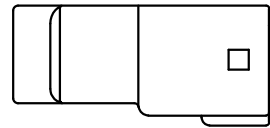
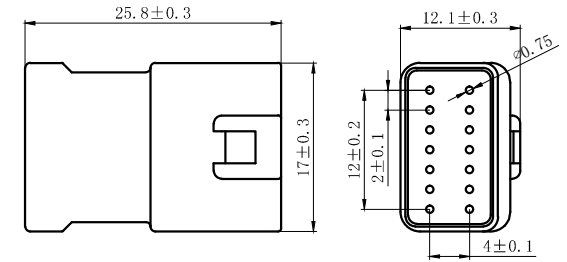
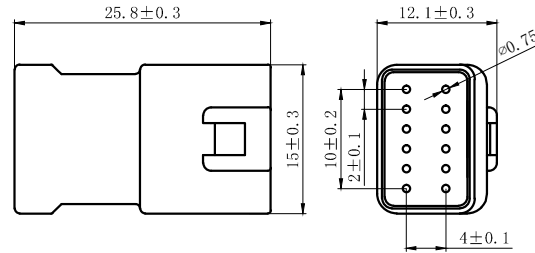
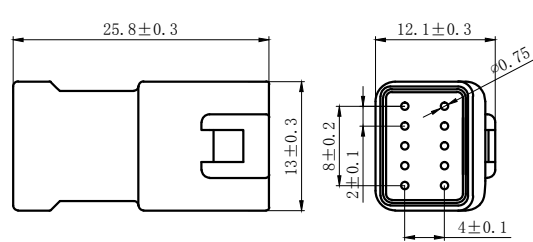

NOTES

- Available in 10.12.14 Circuits.
- Mates with DL20023-Y Series Housing.
- Material : PBT UL94V-0(2).
- Accepts DL20023-RT Crimp Terminal.
- Green Material RoHS Compliant.

GENERAL TOLERANCES (UNLESS SPECIFIED)		ZHE JIANG DELI CONNECTORS CO., LTD	
.X: ± 0.30	X° : ± 3.0°	PRODUCT NAME: DL20023-R-0.75	TITLE: 2.0 mm Pitch Wire To Wire Receptacle Housing
.XX: ± 0.15	.X° : ± 2.0°	DR:Chen Quan Long	DATE:21/08/01
.XXX: ± 0.01	.XX° : ± 1.0°	CHKD:Wu Hui	DATE:21/08/01
FINISH: _____		APPD:Ren An De	DATE:21/08/01
DRAWING NO:		UNITS: mm	REV. : A

REV.	REVISION DESCRIPTION	DATE	APPD

DL20023-2R

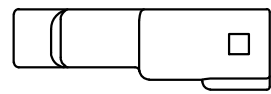
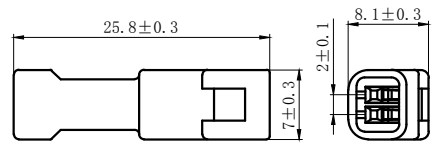

DL20023-3R

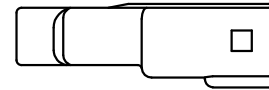
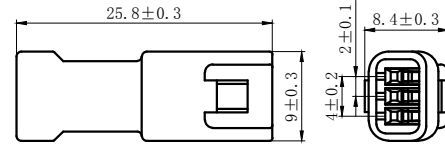

DL20023-8R

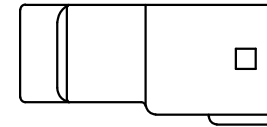
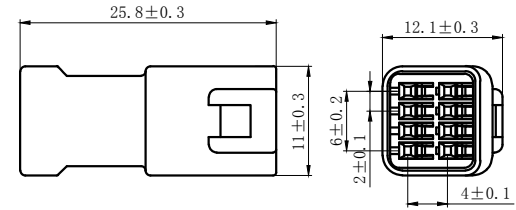

DL20023-4R

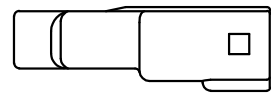
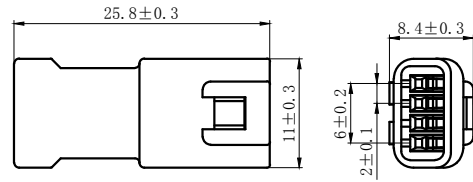

DL20023-6R

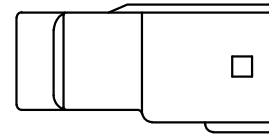
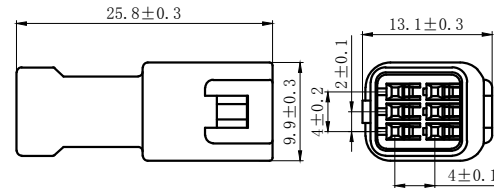

NOTES

Available in 02.03.04.06.08 Circuits.
Mates with DL20023-Y Series Housing.
Material : PBT UL94V-0(2).
Accepts DL20023-RT Crimp Terminal.
Green Material RoHS Compliant.

GENERAL TOLERANCES (UNLESS SPECIFIED)		ZHE JIANG DELI CONNECTORS CO., LTD	
.X: ± 0.30	X° : ± 3.0°	PRODUCT NAME: DL20023-R	TITLE: 2.0 mm Pitch Wire To Wire Receptacle Housing
.XX: ± 0.15	.X° : ± 2.0°	DR:Chen Quan Long	DATE:21/08/01
.XXX: ± 0.01	.XX° : ± 1.0°	DATE:21/08/01	PART NO:
FINISH: _____		CHKD:Wu Hui	DATE:21/08/01
DRAWING NO:		APPD:Ren An De	DATE:21/08/01
		SCALE: N/A	PAGE:1/2
		UNITS: mm	REV.: A

REV.	REVISION DESCRIPTION	DATE	APPD

DL20023-10R

DL20023-12R

DL20023-14R

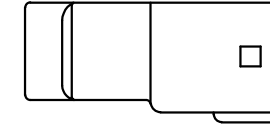
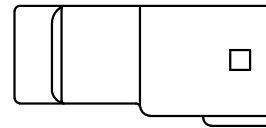
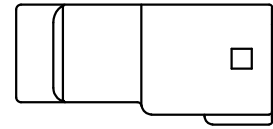
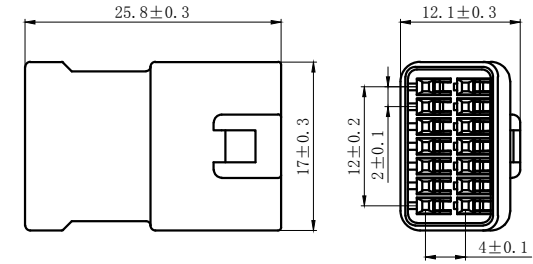
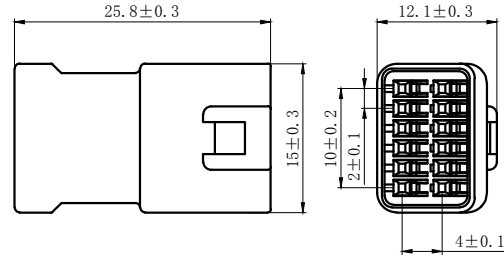
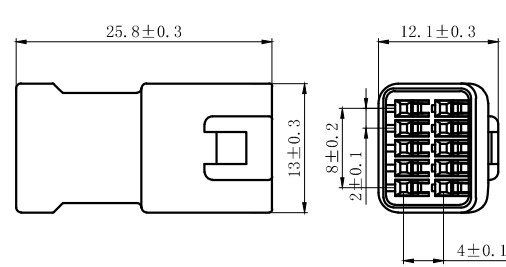

NOTES

- Available in 10.12.14 Circuits.
- Mates with DL20023-Y Series Housing.
- Material : PBT UL94V-0(2).
- Accepts DL20023-RT Crimp Terminal.
- Green Material RoHS Compliant.

GENERAL TOLERANCES (UNLESS SPECIFIED)		ZHE JIANG DELI CONNECTORS CO., LTD	
.X: ± 0.30	X° : ± 3.0°	PRODUCT NAME: DL20023-R	TITLE: 2.0 mm Pitch Wire To Wire Receptacle Housing
.XX: ± 0.15	.X° : ± 2.0°	DR:Chen Quan Long	DATE:21/08/01
.XXX: ± 0.01	.XX° : ± 1.0°	CHKD:Wu Hui	DATE:21/08/01
FINISH: _____		APPD:Ren An De	DATE:21/08/01
DRAWING NO:		UNITS: mm	REV.: A

A

B

C

D

E

F

A

B

C

D

E

F

1

2

3

4

5

6

7

8

REV.	REVISION DESCRIPTION	DATE	APPD

DL20023-2R-0.75

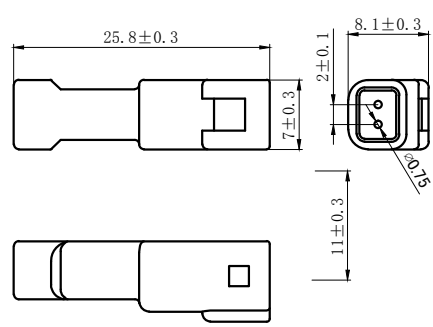

DL20023-3R-0.75

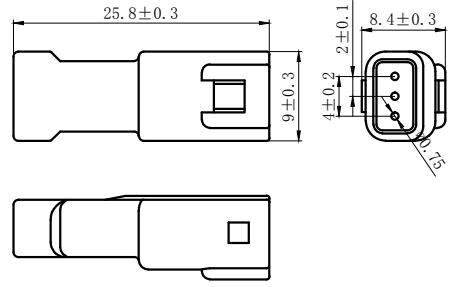

DL20023-8R-0.75

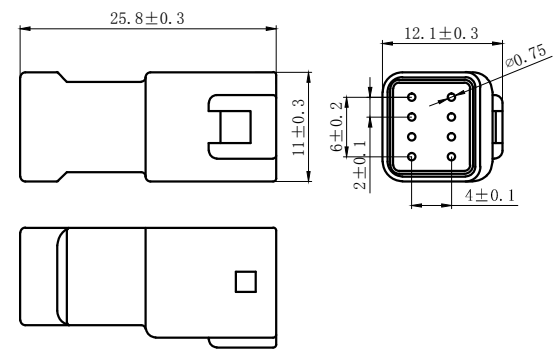

DL20023-4R-0.75

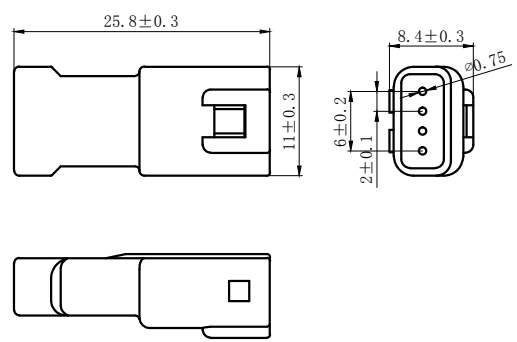

DL20023-6R-0.75

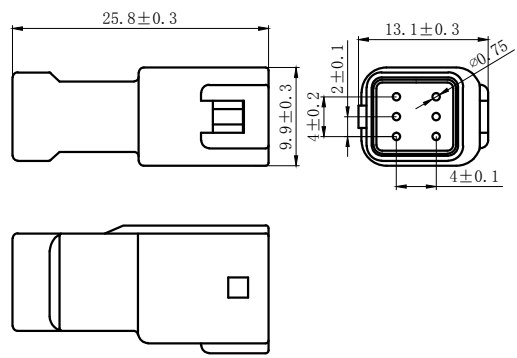

NOTES

Available in 02.03.04.06.08 Circuits.
Mates with DL20023-Y Series Housing.
Material : PBT UL94V-0(2).
Accepts DL20023-RT Crimp Terminal.
Green Material RoHS Compliant.

GENERAL TOLERANCES (UNLESS SPECIFIED)		ZHE JIANG DELI CONNECTORS CO., LTD	
.X: ± 0.30	X° : ± 3.0°	PRODUCT NAME: DL20023-R-0.75	TITLE: 2.0 mm Pitch Wire To Wire Receptacle Housing
.XX: ± 0.15	.X° : ± 2.0°	DR:Chen Quan Long	DATE:21/08/01
.XXX: ± 0.01	.XX° : ± 1.0°	CHKD:Wu Hui	DATE:21/08/01
FINISH: _____		APPD:Ren An De	DATE:21/08/01
DRAWING NO:		SCALE: N/A	PAGE:1/2
		UNITS: mm	REV.: A

DL20023-10Y-0.75

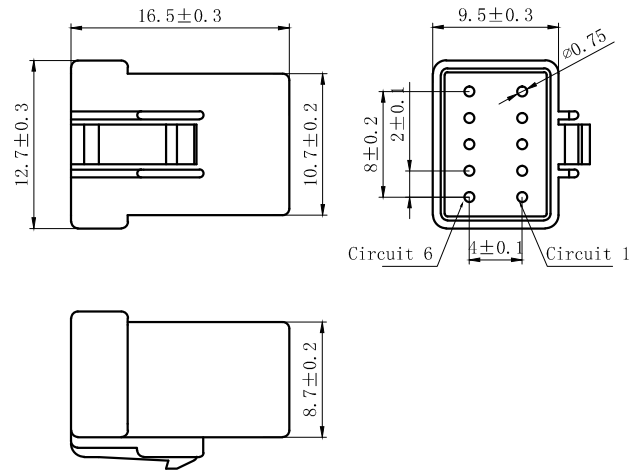

DL20023-12Y-0.75

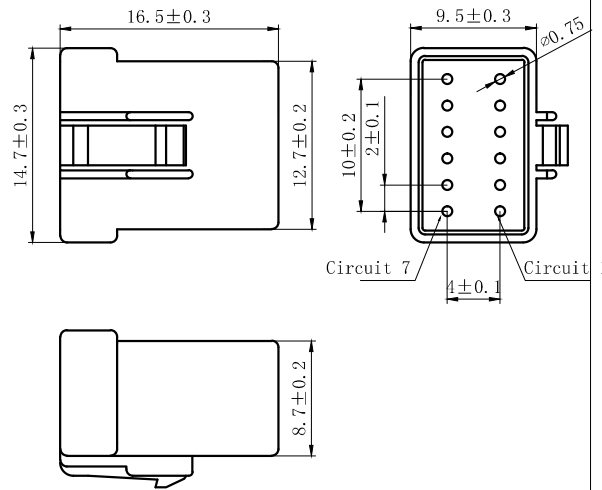

DL20023-14Y-0.75

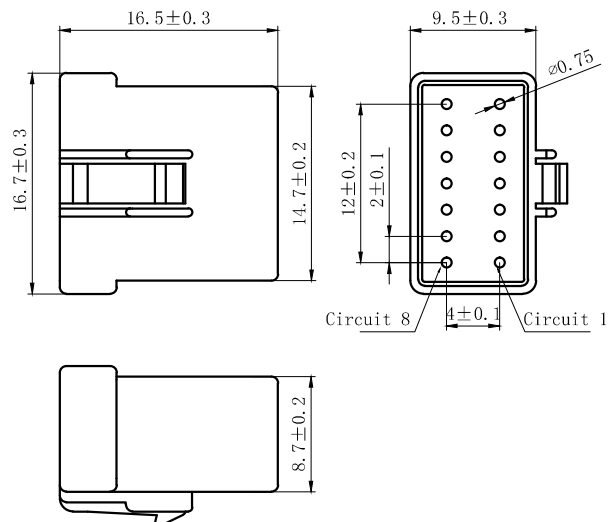

REV.	REVISION DESCRIPTION	DATE	APPD

NOTES

Available in 10.12.14 Circuits.
 Mates with DL20023 Series Housing.
 Material : PBT UL94V-0(2).
 Accepts DL20023-T Crimp Terminal.
 Green Material RoHS Compliant.

GENERAL TOLERANCES (UNLESS SPECIFIED)		ZHE JIANG DELI CONNECTORS CO.,LTD	
.X: ± 0.30	X° ± 3.0°	PRODUCT NAME: DL20023-Y-0.75	TITLE: 2.0 mm Pitch Housing
.XX: ± 0.15	.X° ± 2.0°	DR:Chen Quan Long	DATE:21/08/01
.XXX: ± 0.01	.X° ± 1.0°	CHKD:Wu Hui	DATE:21/08/01
FINISH: _____		APPD:Ren An De	DATE:21/08/01
DRAWING NO:		SCALE: N/A	PAGE:2/2
		UNITS: mm	REV.: A

REV.	REVISION DESCRIPTION	DATE	APPD

NOTES

Mates with DL20023-Y or DL20023-R Series Housing.

Material : PBT UL94V-0 (2).

Green Material RoHS Compliant.

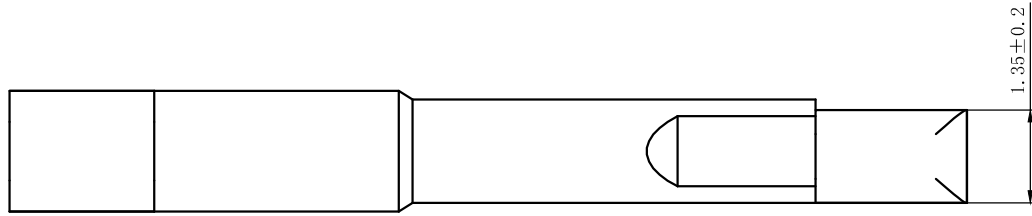
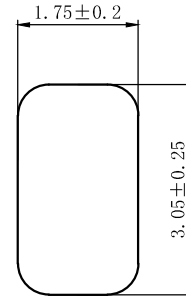
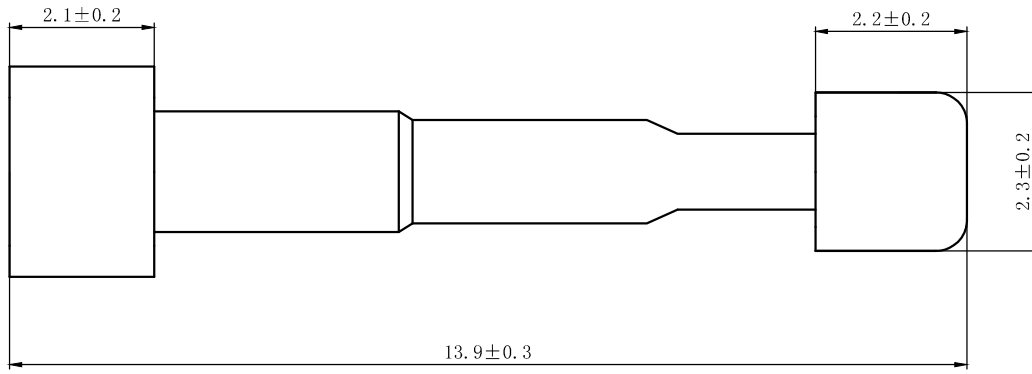

GENERAL TOLERANCES (UNLESS SPECIFIED)		ZHE JIANG DELI CONNECTORS CO., LTD	
.X: ± 0.30	X° : ± 3.0°	PRODUCT NAME: DL20023-1E	TITLE: 2.0 mm Pitch Wire To Wire Receptacle Stopper
.XX: ± 0.15	.X° : ± 2.0°	DR:KeXianQiang	DATE:17.10.12
.XXX: ± 0.01	.XX° : ± 1.0°	CHKD: Liu Bing	DATE:17.10.12
FINISH: _____		APPD:Ren An De	DATE:17.10.12
DRAWING NO:		SCALE: N/A	PAGE:1/1
		UNITS: mm	REV. : A

REV.	REVISION DESCRIPTION	DATE	APPD

NOTES

Used in DL20023-Y Series Housing.
 Accepts AWG #26~22 Wire Range.
 0.13~ 0.33 mm² .
 Insulation O.D.=1.4~1.7mm.
 Material : Phosphor Bronze .
 Finish: Tin plated.
 Qty/Reel: 10,000 PCS.
 Thickness: 0.25 mm.

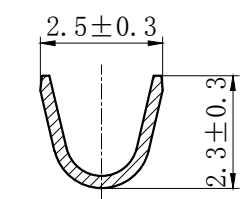
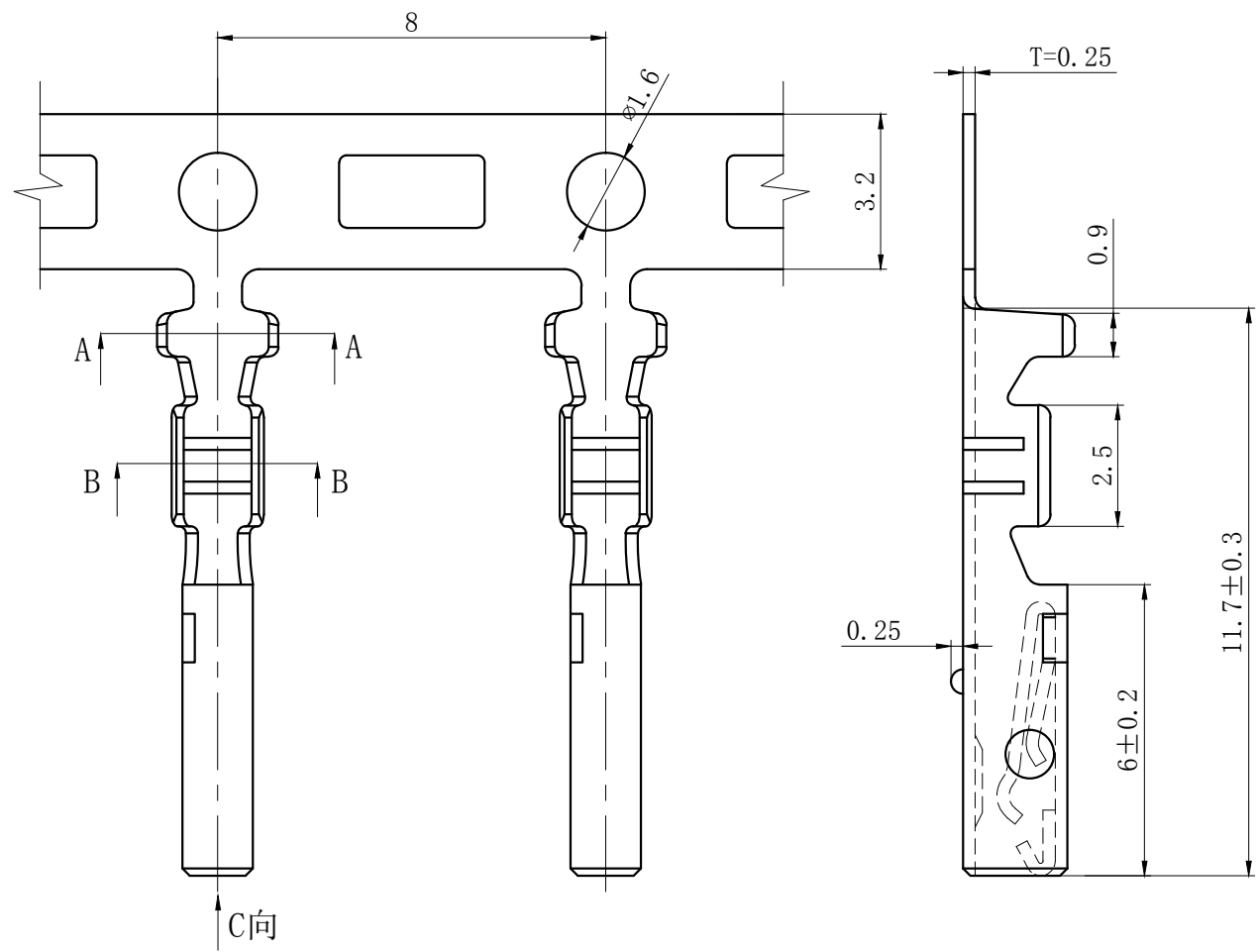

SECTION A-A

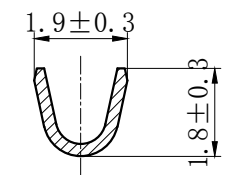

SECTION B-B

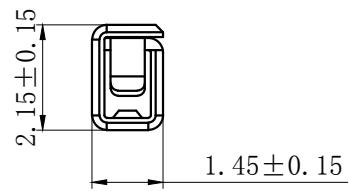

SECTION C-C

GENERAL TOLERANCES (UNLESS SPECIFIED)		ZHE JIANG DELI CONNECTORS CO., LTD	
.X: ± 0.25	X° : ± 3.0°	PRODUCT NAME: DL20023-T	TITLE: 2.00 mm Pitch Crimp Terminal
.XX: ± 0.15	.X° : ± 2.0°	DR:Chen Quan Long	DATE:20/12/23
.XXX: ± 0.01	.XX° : ± 1.0°	CHKD:Wu Hui	DATE:20/12/23
DRAWING NO:		APPD:Ren An De	DATE:20/12/23
		SCALE: N/A	PAGE: 1/1
		UNITS: mm	REV.: A

REV.	REVISION DESCRIPTION	DATE	APPD

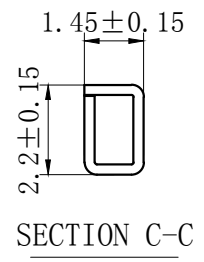
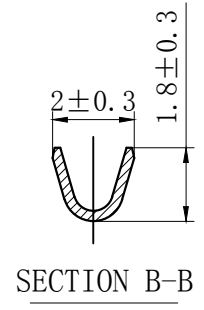
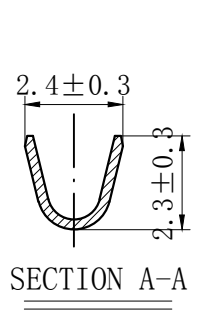
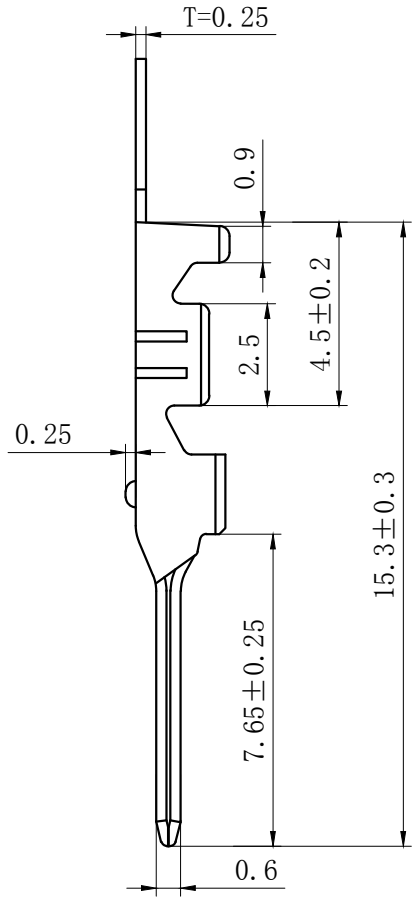
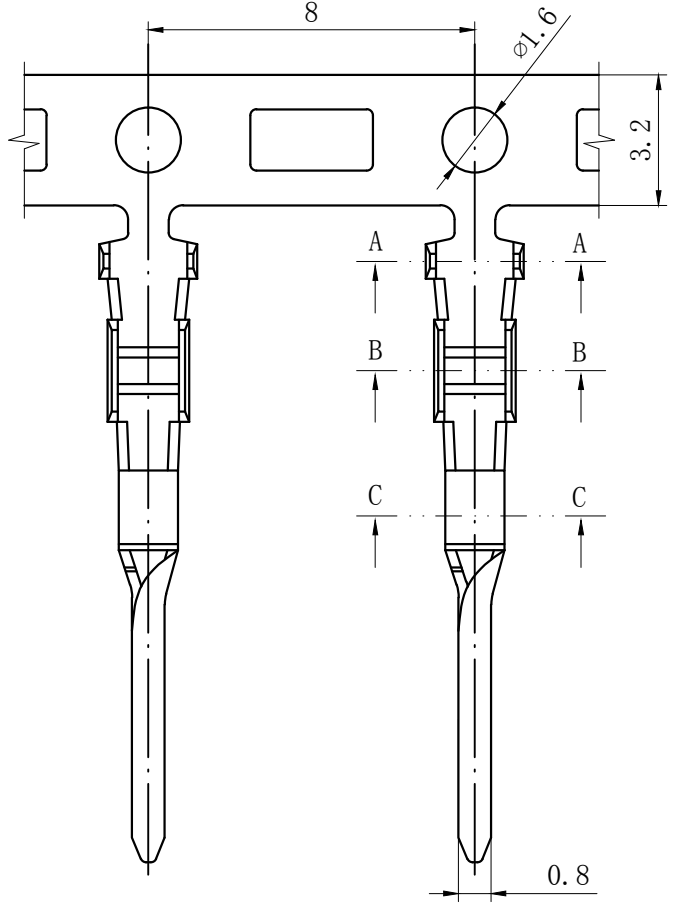

NOTES

Used in DL20023-R Series Housing.

Accepts AWG #26~22 Wire Range.
 $0.13 \sim 0.33 \text{ mm}^2$.

Insulation O.D. = $1.4 \sim 1.7 \text{ mm}$.

Material : Phosphor Bronze .

Finish: Tin plated.

Qty/Reel: 10,000 PCS.

Thickness: 0.25 mm.

GENERAL TOLERANCES (UNLESS SPECIFIED)		ZHE JIANG DELI CONNECTORS CO., LTD	
.X: ± 0.25	X° : ± 3.0°	PRODUCT NAME: DL20023-RT	TITLE: 2.00 mm Pitch Wire To Wire Crimp Terminal
.XX: ± 0.15	.X° : ± 2.0°	DR: Chen Quan Long	DATE: 20/12/23
.XXX: ± 0.01	.XX° : ± 1.0°	CHKD: Wu Hui	DATE: 20/12/23
DRAWING NO:		APPD: Ren An De	DATE: 20/12/23
		SCALE: N/A	PAGE: 1/1
		UNITS: mm	REV.: A

X-ON Electronics

Largest Supplier of Electrical and Electronic Components

Click to view similar products for [Headers & Wire Housings](#) category:

Click to view products by [DLL](#) manufacturer:

Other Similar products are found below :

[0015917161](#) [0022155065](#) [57102-F02-18ULF](#) [58102-G61-06LF](#) [582553-1](#) [01.001.5753.1](#) [0050291907](#) [02.125.8002.8](#) [609-3404](#) [61062-3](#)
[CSU011177004](#) [622-0430](#) [622-3653LF](#) [63453-116](#) [636-1030](#) [636-1427](#) [636-3427](#) [636-4007](#) [641938-9](#) [65495-038](#) [65692-001LF](#) [65781-018](#)
[65781-047](#) [65817-010LF](#) [65817-015LF](#) [67095-007LF](#) [67601157](#) [68631-112](#) [68645-018](#) [699319-000](#) [70.362.1628.0](#) [70-4210](#) [70-4226B](#) [70-](#)
[4853B](#) [71.350.2428.0](#) [733-134](#) [733-162](#) [MHR-64-VUAL](#) [80.063.4001.1](#) [800-90-001-10-001000](#) [801-43-002-10-013000](#) [801-43-006-10-](#)
[002000](#) [803-43-024-10-001000](#) [803-93-012-10-001000](#) [8-1437020-4](#) [819-22-004-30-001101](#) [820-22-006-30-001101](#) [820-22-008-30-001101](#)
[821-22-002-10-001101](#) [821-22-003-10-002101](#)