

## 技术特性/Specifications:

额定电压 Rated voltage: 250V AC, DC  
额定电流 Rated current: 3A AC, DC  
接触电阻 Contact resistance: 20mΩ max  
绝缘电阻 Insulation resistance: 1000MΩ min  
耐压 Withstand voltage: 1000V AC/minute  
环境温度 Ambient temperature: -40℃~+105℃  
适用线规 Wire range: AWG#32~#28



| REV. | REVISION DESCRIPTION | DATE | APPD |
|------|----------------------|------|------|
|      |                      |      |      |



SECTION A-A



NORES:

- 1、Rated voltage: 250V AC DC
- 2、Rated current: 3A AC DC
- 3、Contact resistance:  $\leq 20 \text{ m}\Omega$
- 4、Insulation resistance:  $\geq 1000 \text{ m}\Omega$
- 5、Withstand voltage: 1000V AC/minute
- 6、Ambient temprature:  $-25^{\circ}\text{C} \sim 85^{\circ}\text{C}$
- 7、Materials:LCP UL94V-0
- 8、Matched RoHS criteria



|    |    |     |     |    |         |
|----|----|-----|-----|----|---------|
| 3  | ③  | 基座  | LCP | 1  | UL94-V0 |
| 2  | ②  | 焊片  | 黄铜  | 2  | 镀锡      |
| 1  | ①  | 接触件 | 黄铜  | N* | 镀锡      |
| 序号 | 图号 | 名称  | 材料  | 数量 | 附件      |

| Circuits | Product name | Dimension mm |       | Circuits | Product name | Dimension mm |       |
|----------|--------------|--------------|-------|----------|--------------|--------------|-------|
|          |              | A            | B     |          |              | A            | B     |
| 2        | DL25018-2AB  | 2.50         | 10.00 | 10       | DL25018-10AB | 22.50        | 30.00 |
| 3        | DL25018-3AB  | 5.00         | 12.50 | 11       | DL25018-11AB | 25.00        | 32.50 |
| 4        | DL25018-4AB  | 7.50         | 15.00 | 12       | DL25018-12AB | 27.50        | 35.00 |
| 5        | DL25018-5AB  | 10.00        | 17.50 | 13       | DL25018-13AB | 30.00        | 37.50 |
| 6        | DL25018-6AB  | 12.50        | 20.00 | 14       | DL25018-14AB | 32.50        | 40.00 |
| 7        | DL25018-7AB  | 15.00        | 22.50 | 15       | DL25018-15AB | 35.00        | 42.50 |
| 8        | DL25018-8AB  | 17.50        | 25.00 | -        | -            | -            | -     |
| 9        | DL25018-9AB  | 20.00        | 27.50 | 20       | DL25018-20AB | 47.50        | 55.00 |



PCB LAYOUT

| GENERAL TOLERANCES (UNLESS SPECIFIED) |              | ZHE JIANG DELI CONNECTORS CO., LTD |  |
|---------------------------------------|--------------|------------------------------------|--|
| .X: ± 0.25                            | X°: ± 3.0°   | PRODUCT NAME:                      | TITLE: 2.50 mm Pitch Wire To Board SMT Wafer |
| .XX: ± 0.15                           | .X°: ± 2.0°  | DL25018-AB                         |  |
| .XXX: ± 0.01                          | .XX°: ± 1.0° | DR:Chen Quan Long                  | DATE:18/03/03                                |
| FINISH:                               |              | CHKD:Wu Hui                        | DATE:18/03/03                                |
| DRAWING NO:                           |              | APPD:Ren An De                     | DATE:18/03/03                                |
|                                       |              |                                    | PART NO:                                     |
|                                       |              |                                    | SCALE: N/A                                   |
|                                       |              |                                    | PAGE: 1/1                                    |
|                                       |              |                                    | UNITS: mm                                    |
|                                       |              |                                    | REV.: B                                      |

| REV. | REVISION DESCRIPTION | DATE | APPD |
|------|----------------------|------|------|
|      |                      |      |      |

**NORES:**

- 1、Rated voltage: 250V AC DC
- 2、Rated current: 3A AC DC
- 3、Contact resistance:  $\leq 20 \text{ m}\Omega$
- 4、Insulation resistance:  $\geq 1000 \text{ m}\Omega$
- 5、Withstand voltage: 1000V AC/minute
- 6、Ambient temprature:  $-25^{\circ}\text{C} \sim 85^{\circ}\text{C}$
- 7、Materials: LCP UL94V-0
- 8、Matched RoHS criteria



|    |    |     |     |    |         |
|----|----|-----|-----|----|---------|
| 3  | ③  | 基座  | LCP | 1  | UL94-V0 |
| 2  | ②  | 焊片  | 黄铜  | 2  | 镀锡      |
| 1  | ①  | 接触件 | 黄铜  | N* | 镀锡      |
| 序号 | 图号 | 名称  | 材料  | 数量 | 附件      |

Circuit No.1



| Circuits | Product name | Dimension mm |       | Circuits | Product name  | Dimension mm |       |
|----------|--------------|--------------|-------|----------|---------------|--------------|-------|
|          |              | A            | B     |          |               | A            | B     |
| 2        | DL25018-2AWB | 2.50         | 10.00 | 10       | DL25018-10AWB | 22.50        | 30.00 |
| 3        | DL25018-3AWB | 5.00         | 12.50 | 11       | DL25018-11AWB | 25.00        | 32.50 |
| 4        | DL25018-4AWB | 7.50         | 15.00 | 12       | DL25018-12AWB | 27.50        | 35.00 |
| 5        | DL25018-5AWB | 10.00        | 17.50 | 13       | DL25018-13AWB | 30.00        | 37.50 |
| 6        | DL25018-6AWB | 12.50        | 20.00 | 14       | DL25018-14AWB | 32.50        | 40.00 |
| 7        | DL25018-7AWB | 15.00        | 22.50 | 15       | DL25018-15AWB | 35.00        | 42.50 |
| 8        | DL25018-8AWB | 17.50        | 25.00 | -        | -             | -            | -     |
| 9        | DL25018-9AWB | 20.00        | 27.50 | 20       | DL25018-20AWB | 47.50        | 55.00 |



| GENERAL TOLERANCES (UNLESS SPECIFIED) |              | ZHE JIANG DELI CONNECTORS CO., LTD |  |
|---------------------------------------|--------------|------------------------------------|--|
| .X: ± 0.25                            | X°: ± 3.0°   | PRODUCT NAME:                      | TITLE: 2.50 mm Pitch Wire To Board SMT Wafer |
| .XX: ± 0.15                           | .X°: ± 2.0°  | DL25018-AWB                        | PART NO:                                     |
| .XXX: ± 0.01                          | .XX°: ± 1.0° | DR:Chen Quan Long                  | DATE:23/08/01                                |
| FINISH:                               |              | CHKD:Wu Hui                        | DATE:23/08/01                                |
| DRAWING NO:                           |              | APPD:Ren An De                     | DATE:23/08/01                                |
|                                       |              | SCALE: N/A                         | PAGE: 1/1                                    |
|                                       |              | UNITS: mm                          | REV.: B                                      |

|      |                      |      |      |
|------|----------------------|------|------|
| REV. | REVISION DESCRIPTION | DATE | APPD |
|      |                      |      |      |

### NOTES

Available in 02 through 20 Circuits.  
Mates with DL25018-Y Series Housing.  
Material : Nylon UL94V-0(2).  
0.6mm round Pin.  
Pin Material : Brass / Tin-Plated.

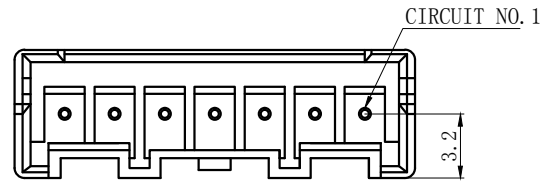
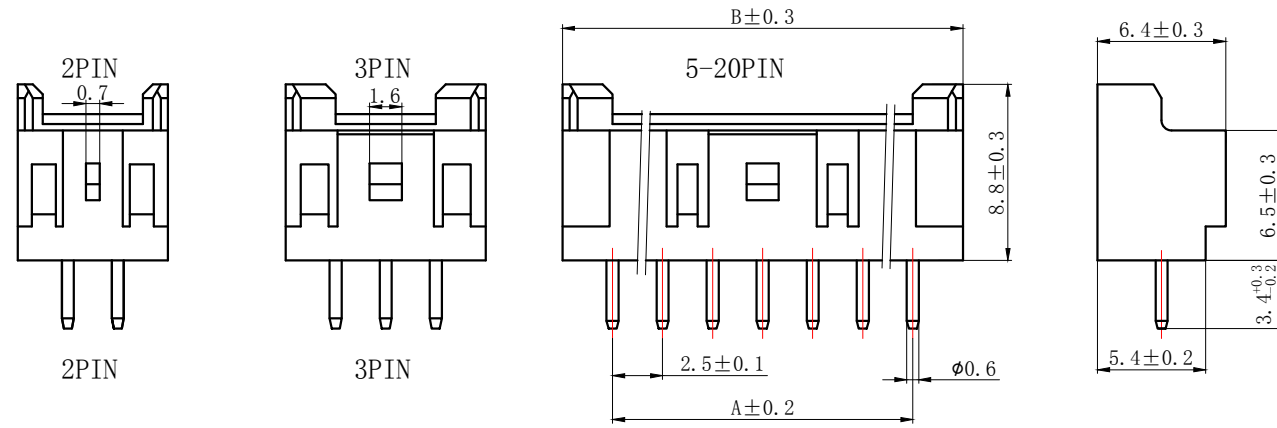

PCB LAYOUT

| Circuits | Product name | Dimension mm |       | Circuits | Product name | Dimension mm |       |
|----------|--------------|--------------|-------|----------|--------------|--------------|-------|
|          |              | A            | B     |          |              | A            | B     |
| 2        | DL25018-2A   | 2.50         | 7.50  | 10       | DL25018-10A  | 22.50        | 27.50 |
| 3        | DL25018-3A   | 5.00         | 10.00 | 11       | DL25018-11A  | 25.00        | 30.00 |
| 4        | DL25018-4A   | 7.50         | 12.50 | 12       | DL25018-12A  | 27.50        | 32.50 |
| 5        | DL25018-5A   | 10.00        | 15.00 | 13       | DL25018-13A  | 30.00        | 35.00 |
| 6        | DL25018-6A   | 12.50        | 17.50 | 14       | DL25018-14A  | 32.50        | 37.50 |
| 7        | DL25018-7A   | 15.00        | 20.00 | 15       | DL25018-15A  | 35.00        | 40.00 |
| 8        | DL25018-8A   | 17.50        | 22.50 | -        | -            | -            | -     |
| 9        | DL25018-9A   | 20.00        | 25.00 | 20       | DL25018-20A  | 47.50        | 52.50 |

#### GENERAL TOLERANCES (UNLESS SPECIFIED)

|              |               |
|--------------|---------------|
| .X: ± 0.25   | X° : ± 3.0°   |
| .XX: ± 0.15  | .X° : ± 2.0°  |
| .XXX: ± 0.01 | .XX° : ± 1.0° |

FINISH:

DRAWING NO:

#### ZHE JIANG DELI CONNECTORS CO., LTD

|                                   |                |  |           |
|-----------------------------------|----------------|--|-----------|
| PRODUCT NAME:<br><b>DL25018-A</b> |                | TITLE:<br>2.50 mm Pitch<br>Wire To Board Wafer |           |
| DR: Chen Quan Long                | DATE: 20/08/01 | PART NO:                                       |           |
| CHKD: Wu Hui                      | DATE: 20/08/01 | SCALE: N/A                                     | PAGE: 1/1 |
| APPD: Ren An De                   | DATE: 20/08/01 | UNITS: mm                                      | REV.: A   |

| REV. | REVISION DESCRIPTION | DATE | APPD |
|------|----------------------|------|------|
|      |                      |      |      |

### NOTES

Available in 02 through 20 Circuits.  
Mates with DL25018-Y Series Housing.  
Material : Nylon UL94V-0(2).  
0.6mm round Pin.  
Pin Material : Brass / Tin-Plated.

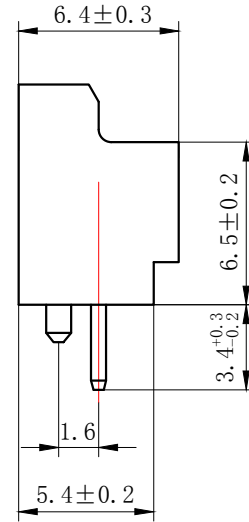

P. C. B LAYOUT

| Circuits | Product name | Dimension mm |       | Circuits | Product name | Dimension mm |       |
|----------|--------------|--------------|-------|----------|--------------|--------------|-------|
|          |              | A            | B     |          |              | A            | B     |
| 2        | DL25018-2AS  | 2.50         | 7.50  | 10       | DL25018-10AS | 22.50        | 27.50 |
| 3        | DL25018-3AS  | 5.00         | 10.00 | 11       | DL25018-11AS | 25.00        | 30.00 |
| 4        | DL25018-4AS  | 7.50         | 12.50 | 12       | DL25018-12AS | 27.50        | 32.50 |
| 5        | DL25018-5AS  | 10.00        | 15.00 | 13       | DL25018-13AS | 30.00        | 35.00 |
| 6        | DL25018-6AS  | 12.50        | 17.50 | 14       | DL25018-14AS | 32.50        | 37.50 |
| 7        | DL25018-7AS  | 15.00        | 20.00 | 15       | DL25018-15AS | 35.00        | 40.00 |
| 8        | DL25018-8AS  | 17.50        | 22.50 | -        | -            | -            | -     |
| 9        | DL25018-9AS  | 20.00        | 25.00 | 20       | DL25018-20AS | 47.50        | 52.50 |

| GENERAL TOLERANCES (UNLESS SPECIFIED) |               | ZHE JIANG DELI CONNECTORS CO., LTD       |               |
|---------------------------------------|---------------|--|---------------|
| .X: ± 0.25                            | .X°: ± 3.0°   | PRODUCT NAME: DL25018-AS                 |               |
| .XX: ± 0.15                           | .XX°: ± 2.0°  | TITLE: 2.50 mm Pitch Wire To Board Wafer |               |
| .XXX: ± 0.01                          | .XXX°: ± 1.0° | DR: Ke Xian Qiang                        | DATE:09/08/01 |
| FINISH:                               |               | CHKD: Liu Bing                           | DATE:09/08/01 |
| DRAWING NO:                           |               | APPD:Ren An De                           | DATE:09/08/01 |
|                                       |               | PART NO:                                 | SCALE: N/A    |
|                                       |               |  | PAGE: 1/1     |
|                                       |               | UNITS: mm                                | REV.: A       |

| REV. | REVISION DESCRIPTION | DATE | APPD |
|------|----------------------|------|------|
|      |                      |      |      |

### NOTES

Available in 02 through 20 Circuits.  
Mates with DL25018-Y Series Housing.  
Material : Nylon UL94V-0(2).  
0.6mm round Pin.  
Pin Material : Brass / Tin-Plated



PCB LAYOUT

| Circuits | Product name | Dimension mm |       | Circuits | Product name  | Dimension mm |       |
|----------|--------------|--------------|-------|----------|---------------|--------------|-------|
|          |              | A            | B     |          |               | A            | B     |
| 2        | DL25018-2AWD | 2.50         | 7.50  | 10       | DL25018-10AWD | 22.50        | 27.50 |
| 3        | DL25018-3AWD | 5.00         | 10.00 | 11       | DL25018-11AWD | 25.00        | 30.00 |
| 4        | DL25018-4AWD | 7.50         | 12.50 | 12       | DL25018-12AWD | 27.50        | 32.50 |
| 5        | DL25018-5AWD | 10.00        | 15.00 | 13       | DL25018-13AWD | 30.00        | 35.00 |
| 6        | DL25018-6AWD | 12.50        | 17.50 | 14       | DL25018-14AWD | 32.50        | 37.50 |
| 7        | DL25018-7AWD | 15.00        | 20.00 | 15       | DL25018-15AWD | 35.00        | 40.00 |
| 8        | DL25018-8AWD | 17.50        | 22.50 | -        | -             | -            | -     |
| 9        | DL25018-9AWD | 20.00        | 25.00 | 20       | DL25018-20AWD | 47.50        | 52.50 |

| GENERAL TOLERANCES (UNLESS SPECIFIED) |               |                                     |                | ZHE JIANG DELI CONNECTORS CO., LTD          |  |           |  |
|---------------------------------------|---------------|-------------------------------------|----------------|---|--|-----------|--|
| .X: ± 0.25                            | X° : ± 3.0°   | PRODUCT NAME:<br><b>DL25018-AWD</b> |                | TITLE: 2.50 mm Pitch<br>Wire To Board Wafer |  |           |  |
| .XX: ± 0.15                           | .X° : ± 2.0°  | DR: Chen Quan Long                  | DATE: 20/08/01 | PART NO:                                    |  |           |  |
| .XXX: ± 0.01                          | .XX° : ± 1.0° | CHKD: Wu Hui                        | DATE: 20/08/01 | SCALE: N/A                                  |  | PAGE: 1/1 |  |
| DRAWING NO:                           |               | APPD: Ren An De                     | DATE: 20/08/01 | UNITS: mm                                   |  | REV.: A   |  |

| REV. | REVISION DESCRIPTION | DATE | APPD |
|------|----------------------|------|------|
|      |                      |      |      |

### NOTES

Available in 02 through 20 Circuits.  
 Mates with DL25018-Y Series Housing.  
 Material : Nylon UL94V-0(2).  
 0.6mm round Pin.  
 Pin Material : Brass / Tin-Plated.

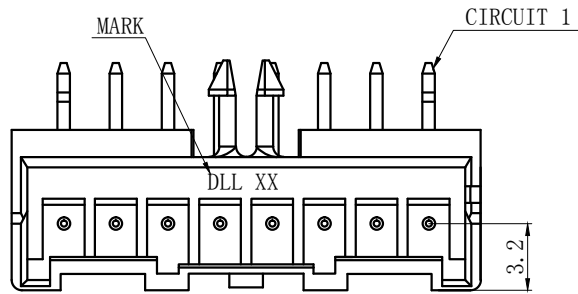

| Circuits | Product name   | Dimension mm |       | Circuits | Product name    | Dimension mm |       |
|----------|----------------|--------------|-------|----------|-----------------|--------------|-------|
|          |                | A            | B     |          |                 | A            | B     |
| 2        | DL25018-2AWD-S | 2.50         | 7.50  | 10       | DL25018-10AWD-S | 22.50        | 27.50 |
| 3        | DL25018-3AWD-S | 5.00         | 10.00 | 11       | DL25018-11AWD-S | 25.00        | 30.00 |
| 4        | DL25018-4AWD-S | 7.50         | 12.50 | 12       | DL25018-12AWD-S | 27.50        | 32.50 |
| 5        | DL25018-5AWD-S | 10.00        | 15.00 | 13       | DL25018-13AWD-S | 30.00        | 35.00 |
| 6        | DL25018-6AWD-S | 12.50        | 17.50 | 14       | DL25018-14AWD-S | 32.50        | 37.50 |
| 7        | DL25018-7AWD-S | 15.00        | 20.00 | 15       | DL25018-15AWD-S | 35.00        | 40.00 |
| 8        | DL25018-8AWD-S | 17.50        | 22.50 | -        | -               | -            | -     |
| 9        | DL25018-9AWD-S | 20.00        | 25.00 | 20       | DL25018-20AWD-S | 47.50        | 52.50 |

| GENERAL TOLERANCES<br>(UNLESS SPECIFIED) |              | ZHE JIANG DELI CONNECTORS CO., LTD    |                |   |           |
|--|--------------|---------------------------------------|----------------|---|-----------|
| .X: ± 0.25                               | X°: ± 3.0°   | PRODUCT NAME:<br><b>DL25018-AWD-S</b> |                | TITLE: 2.50 mm Pitch<br>Wire To Board Wafer |           |
| .XX: ± 0.15                              | .X°: ± 2.0°  | DR: Chen Quan Long                    | DATE: 20/08/01 | PART NO:                                    |           |
| .XXX: ± 0.01                             | .XX°: ± 1.0° | CHKD: Wu Hui                          | DATE: 20/08/01 | SCALE: N/A                                  | PAGE: 1/1 |
| DRAWING NO:                              |              | APPD: Ren An De                       | DATE: 20/08/01 | UNITS: mm                                   | REV.: A   |

|      |                      |      |      |
|------|----------------------|------|------|
| REV. | REVISION DESCRIPTION | DATE | APPD |
|      |                      |      |      |

## NOTES

Available in 02 through 20 Circuits.

Match with DL25018 series housing

Material : Nylon UL94V-0(2).

Accepts DL25018-T Crimp Terminal.

CIRCUIT NO. 1

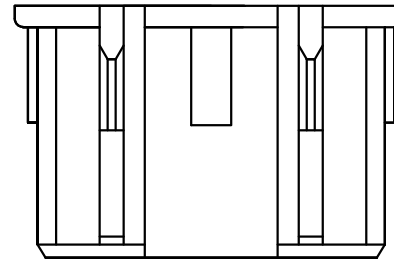
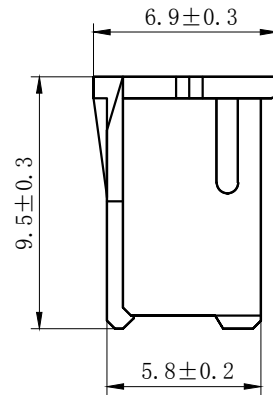
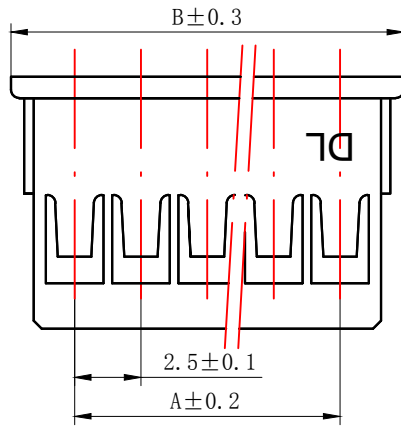
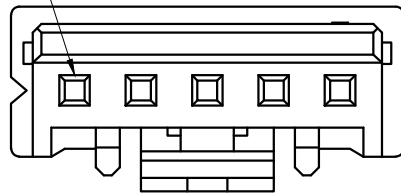

| Circuits | Product name | Dimension mm |       | Circuits | Product name | Dimension mm |       |
|----------|--------------|--------------|-------|----------|--------------|--------------|-------|
|          |              | A            | B     |          |              | A            | B     |
| 2        | DL25018-2Y   | 2.50         | 7.30  | 12       | DL25018-12Y  | 27.50        | 32.30 |
| 3        | DL25018-3Y   | 5.00         | 9.80  | 13       | DL25018-13Y  | 30.00        | 34.80 |
| 4        | DL25018-4Y   | 7.50         | 12.30 | 14       | DL25018-14Y  | 32.50        | 37.30 |
| 5        | DL25018-5Y   | 10.00        | 14.80 | 15       | DL25018-15Y  | 35.00        | 39.80 |
| 6        | DL25018-6Y   | 12.50        | 17.30 | 16       | DL25018-16Y  | 37.50        | 42.30 |
| 7        | DL25018-7Y   | 15.00        | 19.80 | 17       | DL25018-17Y  | 40.00        | 44.80 |
| 8        | DL25018-8Y   | 17.50        | 22.30 | 18       | DL25018-18Y  | 42.50        | 47.30 |
| 9        | DL25018-9Y   | 20.00        | 24.80 | 19       | DL25018-19Y  | 45.00        | 47.30 |
| 10       | DL25018-10Y  | 22.50        | 27.30 | 20       | DL25018-20Y  | 47.50        | 52.30 |
| 11       | DL25018-11Y  | 25.00        | 29.80 |          |              |              |       |

|  |               |                                    |                                 |
|--|---------------|------------------------------------|---------------------------------|
| GENERAL TOLERANCES<br>(UNLESS SPECIFIED) |               | ZHE JIANG DELI CONNECTORS CO., LTD |                                 |
| .X: ± 0.25                               | X° : ± 3.0°   | PRODUCT NAME:<br><b>DL25018-Y</b>  | TITLE:<br>2.50 mm Pitch Housing |
| .XX: ± 0.15                              | .X° : ± 2.0°  | DR: Chen Quan Long                 | DATE: 20/08/01                  |
| .XXX: ± 0.01                             | .XX° : ± 1.0° | DATE: 20/08/01                     | PART NO:                        |
| FINISH:                                  |               | CHKD: Wu Hui                       | DATE: 20/08/01                  |
| DRAWING NO:                              |               | APPD: Ren An De                    | DATE: 20/08/01                  |
|  |               | SCALE: N/A                         | PAGE: 1/1                       |
|  |               | UNITS: mm                          | REV.: A                         |



|      |                      |      |      |
|------|----------------------|------|------|
| REV. | REVISION DESCRIPTION | DATE | APPD |
|      |                      |      |      |

**NORES:**

1. Rated voltage: 250V AC/DC
2. Rated current: 3A AC DC
3. Contact resistance:  $\leq 20 \text{ m}\Omega$
4. Insulation resistance:  $\geq 500 \text{ m}\Omega$
5. Withstand voltage: 1500V AC/minute
6. Ambient temperature:  $-25^{\circ}\text{C} \sim 85^{\circ}\text{C}$
7. Materials: Nylon UL94V-0 (2)
8. Matched RoHS criteria



安装尺寸图

| Circuits | Product name | Dimension mm |       |       |       |       | Circuits | Product name | Dimension mm |       |       |       |       |
|----------|--------------|--------------|-------|-------|-------|-------|----------|--------------|--------------|-------|-------|-------|-------|
|          |              | A            | B     | C     | D     | E     |          |              | A            | B     | C     | D     | E     |
| 2        | DL25018-2R   | 2.50         | 7.50  | 5.90  | 7.90  | 11.20 | 10       | DL25018-10R  | 22.50        | 27.50 | 25.90 | 27.90 | 31.20 |
| 3        | DL25018-3R   | 5.00         | 10.00 | 8.40  | 10.40 | 13.70 | 11       | DL25018-11R  | 25.00        | 30.00 | 28.40 | 30.40 | 33.70 |
| 4        | DL25018-4R   | 7.50         | 12.50 | 10.90 | 12.90 | 16.20 | 12       | DL25018-12R  | 27.50        | 32.50 | 30.90 | 32.90 | 36.20 |
| 5        | DL25018-5R   | 10.00        | 15.00 | 13.40 | 15.40 | 18.70 | 13       | DL25018-13R  | 30.00        | 35.00 | 33.40 | 35.40 | 38.70 |
| 6        | DL25018-6R   | 12.50        | 17.50 | 15.90 | 17.90 | 21.20 | 14       | DL25018-14R  | 32.50        | 37.50 | 35.90 | 37.90 | 41.20 |
| 7        | DL25018-7R   | 15.00        | 20.00 | 18.40 | 20.40 | 23.70 | 15       | DL25018-15R  | 35.00        | 40.00 | 38.40 | 40.40 | 43.70 |
| 8        | DL25018-8R   | 17.50        | 22.50 | 20.90 | 22.90 | 26.20 | -        | -            | -            | -     | -     | -     | -     |
| 9        | DL25018-9R   | 20.00        | 25.00 | 23.40 | 25.40 | 28.70 | 20       | DL25018-20R  | 47.50        | 52.50 | 50.90 | 52.90 | 56.20 |

|                                       |              |                                    |  |
|---------------------------------------|--------------|------------------------------------|--|
| GENERAL TOLERANCES (UNLESS SPECIFIED) |              | ZHE JIANG DELI CONNECTORS CO., LTD |  |
| .X: ± 0.25                            | X°: ± 3.0°   | PRODUCT NAME:<br><b>DL25018-R</b>  | TITLE: 2.50 mm Pitch<br>Wire To Wire Housing |
| .XX: ± 0.15                           | .X°: ± 2.0°  | DR: Yuan Jun Rong                  | DATE: 21/12/30                               |
| .XXX: ± 0.01                          | .XX°: ± 1.0° | DATE: 21/12/30                     | PART NO:                                     |
| FINISH:                               |              | CHKD: Wu Hui                       | DATE: 21/12/30                               |
| DRAWING NO:                           |              | APPD: Ren An De                    | DATE: 21/12/30                               |
|                                       |              | SCALE: N/A                         | PAGE: 1/1                                    |
|                                       |              | UNITS: mm                          | REV.: A                                      |

|      |                      |      |      |
|------|----------------------|------|------|
| REV. | REVISION DESCRIPTION | DATE | APPD |
|      |                      |      |      |



**NORES:**

1. Rated voltage: 250V AC/DC
2. Rated current: 3A AC/DC
3. Contact resistance:  $\leq 20 \text{ m}\Omega$
4. Insulation resistance:  $\geq 500 \text{ m}\Omega$
5. Withstand voltage: 1500V AC/minute
6. Ambient temperature:  $-25^{\circ}\text{C} \sim 85^{\circ}\text{C}$
7. Materials: Nylon UL94V-0(2)
8. Matched RoHS criteria



安装尺寸图

| Circuits | Product name | Dimension mm |       |       |       |       | Circuits | Product name | Dimension mm |       |       |       |       |
|----------|--------------|--------------|-------|-------|-------|-------|----------|--------------|--------------|-------|-------|-------|-------|
|          |              | A            | B     | C     | D     | E     |          |              | A            | B     | C     | D     | E     |
| 2        | DL25018-2RF  | 2.50         | 7.50  | 5.90  | 7.90  | 11.20 | 10       | DL25018-10RF | 22.50        | 27.50 | 25.90 | 27.90 | 31.20 |
| 3        | DL25018-3RF  | 5.00         | 10.00 | 8.40  | 10.40 | 13.70 | 11       | DL25018-11RF | 25.00        | 30.00 | 28.40 | 30.40 | 33.70 |
| 4        | DL25018-4RF  | 7.50         | 12.50 | 10.90 | 12.90 | 16.20 | 12       | DL25018-12RF | 27.50        | 32.50 | 30.90 | 32.90 | 36.20 |
| 5        | DL25018-5RF  | 10.00        | 15.00 | 13.40 | 15.40 | 18.70 | 13       | DL25018-13RF | 30.00        | 35.00 | 33.40 | 35.40 | 38.70 |
| 6        | DL25018-6RF  | 12.50        | 17.50 | 15.90 | 17.90 | 21.20 | 14       | DL25018-14RF | 32.50        | 37.50 | 35.90 | 37.90 | 41.20 |
| 7        | DL25018-7RF  | 15.00        | 20.00 | 18.40 | 20.40 | 23.70 | 15       | DL25018-15RF | 35.00        | 40.00 | 38.40 | 40.40 | 43.70 |
| 8        | DL25018-8RF  | 17.50        | 22.50 | 20.90 | 22.90 | 26.20 | -        | -            | -            | -     | -     | -     | -     |
| 9        | DL25018-9RF  | 20.00        | 25.00 | 23.40 | 25.40 | 28.70 | 20       | DL25018-20RF | 47.50        | 52.50 | 50.90 | 52.90 | 56.20 |

|                                       |                         |                                    |  |
|---------------------------------------|-------------------------|------------------------------------|--|
| GENERAL TOLERANCES (UNLESS SPECIFIED) |                         | ZHE JIANG DELI CONNECTORS CO., LTD |  |
| .X: $\pm 0.25$                        | X°: $\pm 3.0^{\circ}$   | PRODUCT NAME:<br><b>DL25018-RF</b> | TITLE: 2.50 mm Pitch<br>Wire To Wire Housing |
| .XX: $\pm 0.15$                       | .X°: $\pm 2.0^{\circ}$  | DR: Yuan Jun Rong                  | DATE: 21/12/30                               |
| .XXX: $\pm 0.01$                      | .XX°: $\pm 1.0^{\circ}$ | DATE: 21/12/30                     | PART NO:                                     |
| FINISH:                               |                         | CHKD: Wu Hui                       | DATE: 21/12/30                               |
| DRAWING NO:                           |                         | APPD: Ren An De                    | DATE: 21/12/30                               |
|                                       |                         | SCALE: N/A                         | PAGE: 1/1                                    |
|                                       |                         | UNITS: mm                          | REV.: A                                      |

|      |                      |      |      |
|------|----------------------|------|------|
| REV. | REVISION DESCRIPTION | DATE | APPD |
|      |                      |      |      |

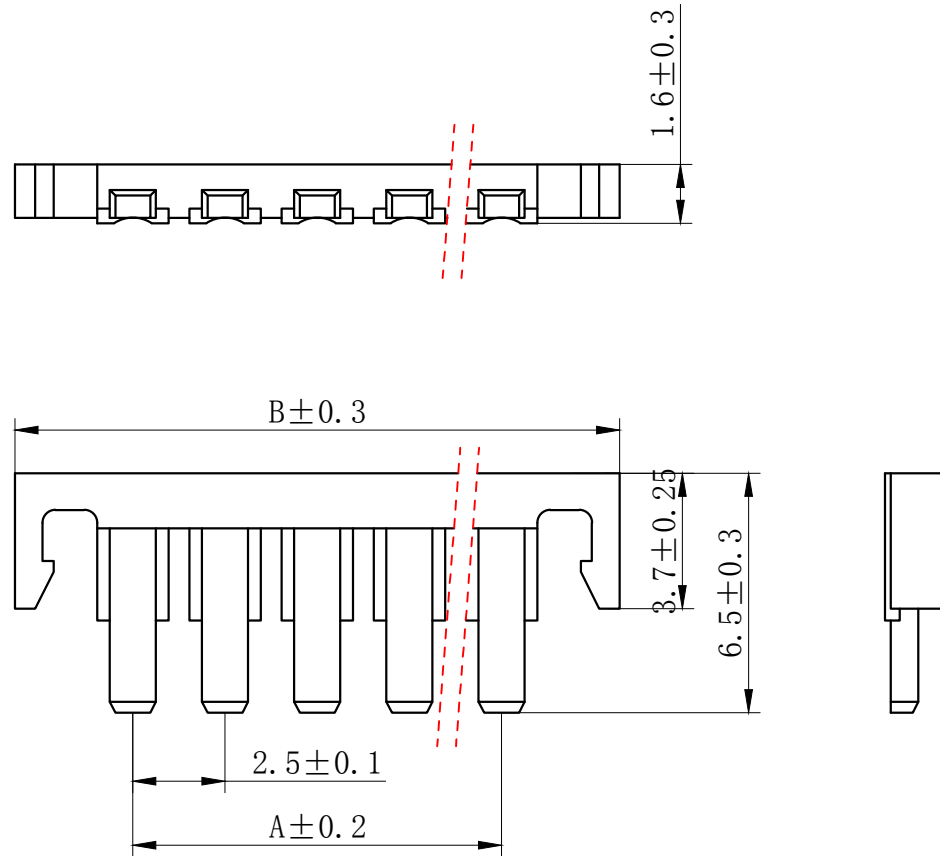

## NOTES

Available in 02 through 20 Circuits.  
 Match with DL25018-Y series housing  
 Material : Nylon UL94V-0(2).

| Circuits | Product name | Dimension mm |      | Circuits | Product name | Dimension mm |      |
|----------|--------------|--------------|------|----------|--------------|--------------|------|
|          |              | A            | B    |          |              | A            | B    |
| 2        | DL25018-2S   | 2.50         | 8.9  | 10       | DL25018-10S  | 22.50        | 28.9 |
| 3        | DL25018-3S   | 5.00         | 11.4 | 11       | DL25018-11S  | 25.00        | 31.4 |
| 4        | DL25018-4S   | 7.50         | 13.9 | 12       | DL25018-12S  | 27.50        | 33.9 |
| 5        | DL25018-5S   | 10.00        | 16.4 | 13       | DL25018-13S  | 30.00        | 36.4 |
| 6        | DL25018-6S   | 12.50        | 18.9 | 14       | DL25018-14S  | 32.50        | 38.9 |
| 7        | DL25018-7S   | 15.00        | 21.4 | 15       | DL25018-15S  | 35.00        | 41.4 |
| 8        | DL25018-8S   | 17.50        | 23.9 | -        | -            | -            | -    |
| 9        | DL25018-9S   | 20.00        | 26.4 | 20       | DL25018-20S  | 47.50        | 43.9 |

|  |                       |                                    |                                 |
|--|-----------------------|------------------------------------|---------------------------------|
| GENERAL TOLERANCES<br>(UNLESS SPECIFIED) |                       | ZHE JIANG DELI CONNECTORS CO., LTD |                                 |
| .X: $\pm 0.25$                           | X°: $\pm 3.0^\circ$   | PRODUCT NAME:<br><b>DL25018-S</b>  | TITLE:<br>2.50 mm Pitch Housing |
| .XX: $\pm 0.15$                          | .X°: $\pm 2.0^\circ$  | DR: Yuan Jun Rong                  | DATE: 20/08/01                  |
| .XXX: $\pm 0.01$                         | .XX°: $\pm 1.0^\circ$ | CHKD: Wu Hui                       | DATE: 20/08/01                  |
| FINISH:                                  |                       | APPD: Ren An De                    | DATE: 20/08/01                  |
| DRAWING NO:                              |                       |                                    | PART NO:                        |
|  |                       |                                    | SCALE: N/A                      |
|  |                       |                                    | PAGE: 1/1                       |
|  |                       |                                    | UNITS: mm                       |
|  |                       |                                    | REV.: A                         |

|      |                      |      |      |
|------|----------------------|------|------|
| REV. | REVISION DESCRIPTION | DATE | APPD |
|      |                      |      |      |

6-8Pin



NOTES

Available in 02 through 20 Circuits.  
 Mates with DL25018-R/DL25034-RK/  
 DL25035/DL25045 Series Housing.  
 Material : Nylon UL94-V0(2).  
 Green Material RoHS Compliant.

1-5Pin



9-20Pin



| Circuits | Product name | Dimension mm |      | Circuits | Product name | Dimension mm |      |
|----------|--------------|--------------|------|----------|--------------|--------------|------|
|          |              | A            | B    |          |              | A            | B    |
| 2        | DL25018-2RS  | 2.50         | 4.4  | 10       | DL25018-10RS | 22.50        | 24.4 |
| 3        | DL25018-3RS  | 5.00         | 6.9  | 11       | DL25018-11RS | 25.00        | 26.9 |
| 4        | DL25018-4RS  | 7.50         | 9.4  | 12       | DL25018-12RS | 27.50        | 29.4 |
| 5        | DL25018-5RS  | 10.00        | 11.9 | 13       | DL25018-13RS | 30.00        | 31.9 |
| 6        | DL25018-6RS  | 12.50        | 14.4 | 14       | DL25018-14RS | 32.50        | 34.4 |
| 7        | DL25018-7RS  | 15.00        | 16.9 | 15       | DL25018-15RS | 35.00        | 36.9 |
| 8        | DL25018-8RS  | 17.50        | 19.4 | -        | -            | -            | -    |
| 9        | DL25018-9RS  | 20.00        | 21.9 | 20       | DL25018-RS   | 47.50        | 49.4 |

|  |              |                                    |                                     |
|--|--------------|------------------------------------|-------------------------------------|
| GENERAL TOLERANCES<br>(UNLESS SPECIFIED) |              | ZHE JIANG DELI CONNECTORS CO., LTD |                                     |
| .X: ± 0.25                               | X°: ± 3.0°   | PRODUCT NAME:<br>DL25018-RS        | TITLE: 2.5 mm Pitch<br>Wire To Wire |
| .XX: ± 0.15                              | .X°: ± 2.0°  | DR: Chen Quan Long                 | DATE: 21/05/01                      |
| .XXX: ± 0.01                             | .XX°: ± 1.0° | CHKD: Wu Hui                       | DATE: 21/05/01                      |
| FINISH:                                  |              | APPD: Ren An De                    | DATE: 21/05/01                      |
| DRAWING NO:                              |              |                                    |                                     |
|  |              | SCALE: N/A                         | PAGE: 1/1                           |
|  |              | UNITS: mm                          | REV.: A                             |

| REV. | REVISION DESCRIPTION | DATE | APPD |
|------|----------------------|------|------|
|      |                      |      |      |

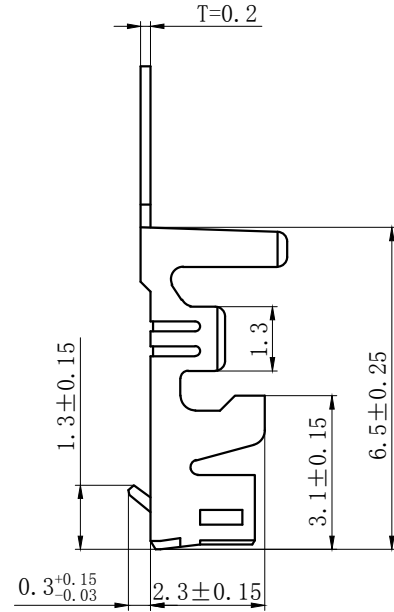

技术特性/Specifications:

额定电压Rated voltage :250V AC.DC.  
 额定电流Rated current :3A AC.DC.  
 接触电阻Contact resistance:20MΩ MAX  
 绝缘电阻Insulation resistance: 1000 MΩ MIN  
 耐压Withstand voltage:1000V AC/minute  
 环境温度Ambient temperature: -40℃~+105℃  
 适用线规 Wire range: AWG#28~#20

材料/Materials:

端子Terminal: 磷青铜Phosphor bronze ,  
 镀锡Tin plated



SECTION A-A



SECTION B-B



SECTION C-C

| Product name | Dimension (mm) |     |     |     | Applicable wire | Insulation O.D. (mm) |
|--------------|----------------|-----|-----|-----|-----------------|----------------------|
|              | A1             | B1  | A2  | B2  |                 |                      |
| DL25018-T    | 2.9            | 3.0 | 1.9 | 1.6 | AWG#28-22       | 1.9mm Max            |
| DL25018-T-G  | 2.9            | 3.0 | 2.3 | 2.1 | AWG#24-20       | 1.9mm Max            |

| GENERAL TOLERANCES (UNLESS SPECIFIED) |              |                            |  | ZHE JIANG DELI CONNECTORS CO., LTD        |         |               |           |
|---------------------------------------|--------------|----------------------------|--|---|---------|---------------|-----------|
| .X: ± 0.25                            | X°: ± 3.0°   | PRODUCT NAME:<br>DL25018-T |  | TITLE:<br>2.50 mm Pitch<br>Crimp Terminal |         |               |           |
| .XX: ± 0.15                           | .X°: ± 2.0°  | DR: Yuan Jun Rong          |  | DATE:21/12/30                             |         | PART NO:      |           |
| .XXX: ± 0.01                          | .XX°: ± 1.0° | FINISH:                    |  | CHKD: Wu Hui                              |         | DATE:21/12/30 |           |
| DRAWING NO:                           |              | APPD:Ren An De             |  | DATE:21/12/30                             |         | SCALE: N/A    | PAGE: 1/1 |
|                                       |              |                            |  | UNITS: mm                                 | REV.: A |               |           |

| REV. | REVISION DESCRIPTION | DATE | APPD |
|------|----------------------|------|------|
|      |                      |      |      |



SECTION A-A



SECTION B-B

技术特性/Specifications:

额定电压 Rated voltage : 250V AC/DC.  
 额定电流 Rated current : 3A AC/DC.  
 接触电阻 Contact resistance: 20MΩ MAX  
 绝缘电阻 Insulation resistance: 500 MΩ MIN  
 耐压 Withstand voltage: 1500V AC/minute  
 环境温度 Ambient temperature: -40℃ ~ +105℃  
 适用线规 Wire range: AWG#28 ~ #20

材料/Materials:

端子 Terminal: 磷青铜 Phosphor bronze ,  
 镀锡 Tin plated

| Product name | Dimension (mm) |     |     |     | Applicable wire | Insulation O.D. (mm) |
|--------------|----------------|-----|-----|-----|-----------------|----------------------|
|              | A1             | B1  | A2  | B2  |                 |                      |
| DL25018-RT   | 2.9            | 2.9 | 1.9 | 1.5 | AWG#28-22       | 1.9mm Max            |
| DL25018-RT-G | 2.9            | 2.9 | 2.2 | 2.1 | AWG#24-20       | 1.9mm Max            |

| GENERAL TOLERANCES (UNLESS SPECIFIED) |              | ZHE JIANG DELI CONNECTORS CO., LTD |  |
|---------------------------------------|--------------|------------------------------------|--|
| .X: ± 0.25                            | X°: ± 3.0°   | PRODUCT NAME:                      | TITLE:                                 |
| .XX: ± 0.15                           | .X°: ± 2.0°  | DL25018-RT                         | 2.50 mm Pitch<br>Wire To Wire Terminal |
| .XXX: ± 0.01                          | .XX°: ± 1.0° | DR: Yuan Jun Rong                  | DATE: 21/12/30                         |
| FINISH:                               |              | CHKD: Wu Hui                       | DATE: 21/12/30                         |
| DRAWING NO:                           |              | APPD: Ren An De                    | DATE: 21/12/30                         |
|                                       |              |                                    | PART NO:                               |
|                                       |              |                                    | SCALE: N/A                             |
|                                       |              |                                    | PAGE: 1/1                              |
|                                       |              |                                    | UNITS: mm                              |
|                                       |              |                                    | REV.: A                                |

| REV. | REVISION DESCRIPTION | DATE | APPD |
|------|----------------------|------|------|
|      |                      |      |      |

### NOTES

Available in 02 through 20 Circuits.  
 Mates with DL25018-Y Series Housing.  
 Material : Nylon UL94V-0.  
 0.60mm Square Pin.  
 Pin Material : Brass / Tin-Plated.

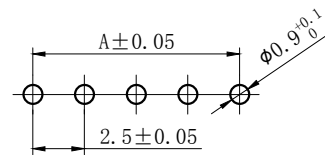

P. C. B LATOUT

| Circuits | Product name | Dimension mm |       |       | Circuits | Product name | Dimension mm |       |       |
|----------|--------------|--------------|-------|-------|----------|--------------|--------------|-------|-------|
|          |              | A            | B     | C     |          |              | A            | B     | C     |
| 2        | XAH-2A       | 2.50         | 7.50  | 5.90  | 10       | XAH-10A      | 22.50        | 27.50 | 25.90 |
| 3        | XAH-3A       | 5.00         | 10.00 | 8.40  | 11       | XAH-11A      | 25.00        | 30.00 | 28.40 |
| 4        | XAH-4A       | 7.50         | 12.50 | 10.90 | 12       | XAH-12A      | 27.50        | 32.50 | 30.90 |
| 5        | XAH-5A       | 10.00        | 15.00 | 13.40 | 13       | XAH-13A      | 30.00        | 35.00 | 33.40 |
| 6        | XAH-6A       | 12.50        | 17.50 | 15.90 | 14       | XAH-14A      | 32.50        | 37.50 | 35.90 |
| 7        | XAH-7A       | 15.00        | 20.00 | 18.40 | 15       | XAH-15A      | 35.00        | 40.00 | 38.40 |
| 8        | XAH-8A       | 17.50        | 22.50 | 20.90 | -        | -            | -            | -     | -     |
| 9        | XAH-9A       | 20.00        | 25.00 | 23.40 | 20       | XAH-20A      | 47.50        | 52.50 | 50.90 |

#### GENERAL TOLERANCES (UNLESS SPECIFIED)

|              |               |
|--------------|---------------|
| .X: ± 0.25   | X° : ± 3.0°   |
| .XX: ± 0.15  | .X° : ± 2.0°  |
| .XXX: ± 0.01 | .XX° : ± 1.0° |
| FINISH:      |               |
| DRAWING NO:  |               |

#### ZHE JIANG DELI CONNECTORS CO., LTD

|  |                |  |           |
|--|----------------|--|-----------|
| PRODUCT NAME:<br><b>DL25035 (XAH) -A</b> |                | TITLE:<br>2.50 mm Pitch<br>Wire To Board Wafer |           |
| DR: Yuan Jun Rong                        | DATE: 19/07/20 | PART NO:                                       |           |
| CHKD: Wu Hui                             | DATE: 19/07/20 | SCALE: N/A                                     | PAGE: 1/1 |
| APPD: Ren An De                          | DATE: 19/07/20 | UNITS: mm                                      | REV.: A   |

|      |                      |      |      |
|------|----------------------|------|------|
| REV. | REVISION DESCRIPTION | DATE | APPD |
|      |                      |      |      |

### NOTES

Available in 02 through 20 Circuits.  
Mates with DL25018-Y Series Housing.  
Material : Nylon UL94V-0.  
0.60mm Square Pin.  
Pin Material : Brass / Tin-Plated.

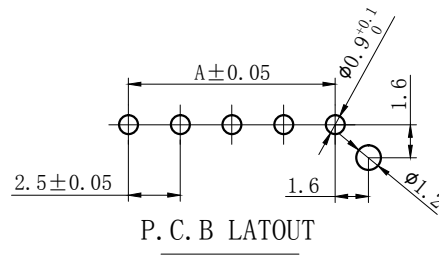
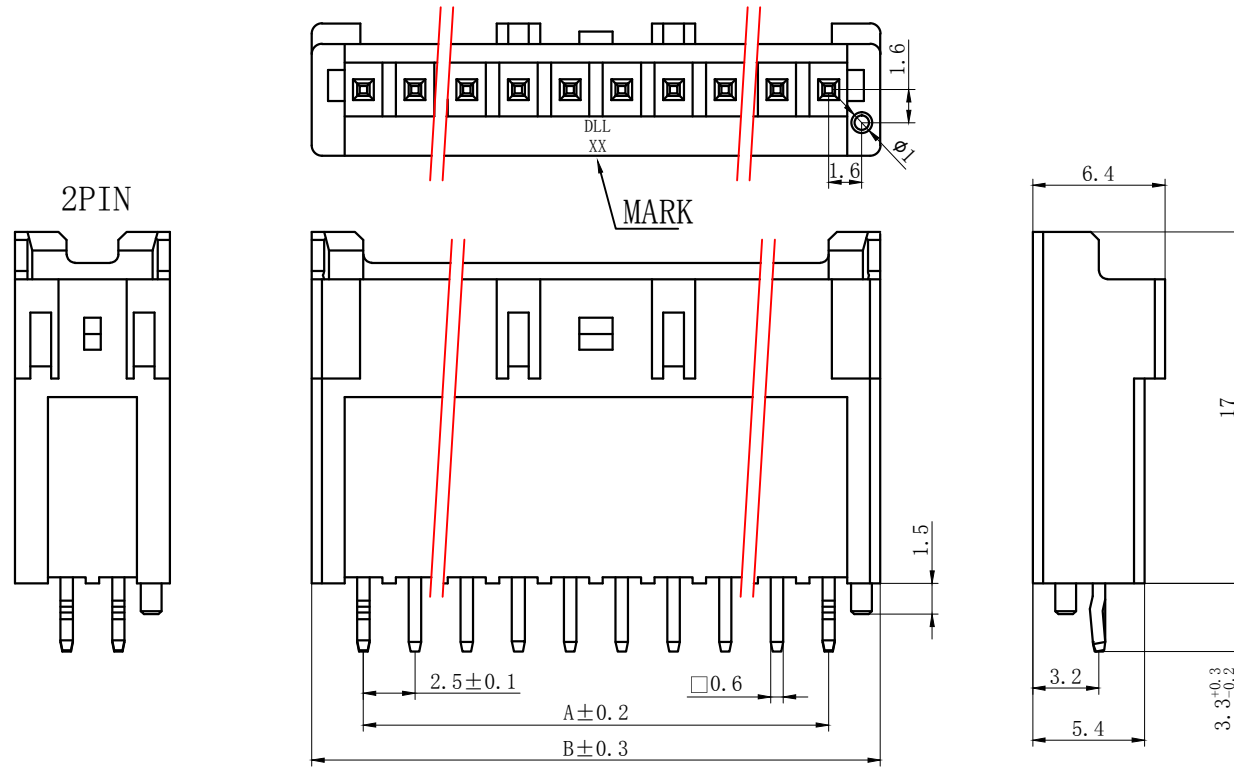

| Circuits | Product name | Dimension mm |       |       | Circuits | Product name | Dimension mm |       |       |
|----------|--------------|--------------|-------|-------|----------|--------------|--------------|-------|-------|
|          |              | A            | B     | C     |          |              | A            | B     | C     |
| 2        | XAH-2AS      | 2.50         | 7.50  | 5.90  | 10       | XAH-10AS     | 22.50        | 27.50 | 25.90 |
| 3        | XAH-3AS      | 5.00         | 10.00 | 8.40  | 11       | XAH-11AS     | 25.00        | 30.00 | 28.40 |
| 4        | XAH-4AS      | 7.50         | 12.50 | 10.90 | 12       | XAH-12AS     | 27.50        | 32.50 | 30.90 |
| 5        | XAH-5AS      | 10.00        | 15.00 | 13.40 | 13       | XAH-13AS     | 30.00        | 35.00 | 33.40 |
| 6        | XAH-6AS      | 12.50        | 17.50 | 15.90 | 14       | XAH-14AS     | 32.50        | 37.50 | 35.90 |
| 7        | XAH-7AS      | 15.00        | 20.00 | 18.40 | 15       | XAH-15AS     | 35.00        | 40.00 | 38.40 |
| 8        | XAH-8AS      | 17.50        | 22.50 | 20.90 | -        | -            | -            | -     | -     |
| 9        | XAH-9AS      | 20.00        | 25.00 | 23.40 | 20       | XAH-20AS     | 47.50        | 52.50 | 50.90 |

|                                       |              |                                    |  |
|---------------------------------------|--------------|------------------------------------|--|
| GENERAL TOLERANCES (UNLESS SPECIFIED) |              | ZHE JIANG DELI CONNECTORS CO., LTD |  |
| .X: ± 0.25                            | X°: ± 3.0°   | PRODUCT NAME:<br>DL25035 (XAH)-AS  | TITLE:<br>2.50 mm Pitch<br>Wire To Board Wafer |
| .XX: ± 0.15                           | .X°: ± 2.0°  | DR: Yuan Jun Rong                  | DATE: 19/07/20                                 |
| .XXX: ± 0.01                          | .XX°: ± 1.0° | CHKD: Wu Hui                       | DATE: 19/07/20                                 |
| FINISH:                               |              | APPD: Ren An De                    | DATE: 19/07/20                                 |
| DRAWING NO:                           |              |                                    |  |
|                                       |              | SCALE: N/A                         | PAGE: 1/1                                      |
|                                       |              | UNITS: mm                          | REV.: A  |



| REV. | REVISION DESCRIPTION | DATE | APPD |
|------|----------------------|------|------|
|      |                      |      |      |



## NOTES

Available in 02 through 20 Circuits.  
 Match with DL25018 or DL25035 series housing  
 Material : Nylon UL94V-0(2).  
 Accepts DL25035-T Crimp Terminal.

| Circuits | Product name | Dimension mm |       | Circuits | Product name | Dimension mm |       |
|----------|--------------|--------------|-------|----------|--------------|--------------|-------|
|          |              | A            | B     |          |              | A            | B     |
| 2        | XAH-2Y       | 2.50         | 7.30  | 12       | XAH-12Y      | 27.50        | 32.30 |
| 3        | XAH-3Y       | 5.00         | 9.80  | 13       | XAH-13Y      | 30.00        | 34.80 |
| 4        | XAH-4Y       | 7.50         | 12.30 | 14       | XAH-14Y      | 32.50        | 37.30 |
| 5        | XAH-5Y       | 10.00        | 14.80 | 15       | XAH-15Y      | 35.00        | 39.80 |
| 6        | XAH-6Y       | 12.50        | 17.30 | 16       | XAH-16Y      | 37.50        | 42.30 |
| 7        | XAH-7Y       | 15.00        | 19.80 | 17       | XAH-17Y      | 40.00        | 44.80 |
| 8        | XAH-8Y       | 17.50        | 22.30 | 18       | XAH-18Y      | 42.50        | 47.30 |
| 9        | XAH-9Y       | 20.00        | 24.80 | 19       | XAH-19Y      | 45.00        | 47.30 |
| 10       | XAH-10Y      | 22.50        | 27.30 | 20       | XAH-20Y      | 47.50        | 52.30 |
| 11       | XAH-11Y      | 25.00        | 29.80 |          |              |              |       |

| GENERAL TOLERANCES<br>(UNLESS SPECIFIED) |               | ZHE JIANG DELI CONNECTORS CO ., LTD      |                                 |
|--|---------------|--|---------------------------------|
| .X: ± 0.25                               | X° : ± 3.0°   | PRODUCT NAME:<br><b>DL25035 (XAH) -Y</b> | TITLE:<br>2.50 mm Pitch Housing |
| .XX: ± 0.15                              | .X° : ± 2.0°  | DR: Chen Quan Long                       | DATE: 20/08/01                  |
| .XXX: ± 0.01                             | .XX° : ± 1.0° | DATE: 20/08/01                           | PART NO:                        |
| FINISH:                                  |               | CHKD: Wu Hui                             | DATE: 20/08/01                  |
| DRAWING NO:                              |               | APPD: Ren An De                          | DATE: 20/08/01                  |
|  |               | SCALE: N/A                               | PAGE: 1/1                       |
|  |               | UNITS: mm                                | REV.: A                         |

## X-ON Electronics

Largest Supplier of Electrical and Electronic Components

*Click to view similar products for [Headers & Wire Housings](#) category:*

*Click to view products by [DLL](#) manufacturer:*

Other Similar products are found below :

[0015917161](#) [0022155065](#) [57102-F02-18ULF](#) [58102-G61-06LF](#) [582553-1](#) [01.001.5753.1](#) [0050291907](#) [02.125.8002.8](#) [609-3404](#) [61062-3](#)  
[CSU011177004](#) [622-0430](#) [622-3653LF](#) [63453-116](#) [636-1030](#) [636-1427](#) [636-3427](#) [636-4007](#) [641938-9](#) [65495-038](#) [65692-001LF](#) [65781-018](#)  
[65781-047](#) [65817-010LF](#) [65817-015LF](#) [67095-007LF](#) [67601157](#) [68631-112](#) [68645-018](#) [699319-000](#) [70.362.1628.0](#) [70-4210](#) [70-4226B](#) [70-](#)  
[4853B](#) [71.350.2428.0](#) [733-134](#) [733-162](#) [760-3052](#) [MHR-64-VUAL](#) [80.063.4001.1](#) [800-90-001-10-001000](#) [801-43-002-10-013000](#)  
[801-43-006-10-002000](#) [803-43-024-10-001000](#) [803-93-012-10-001000](#) [8-1437020-4](#) [819-22-004-30-001101](#) [820-22-006-30-001101](#)  
[820-22-008-30-001101](#) [821-22-002-10-001101](#)