



**技术特性/Specifications:**

额定电压 Rated voltage: 300V AC, DC  
 额定电流 Rated current: 9A AC, DC  
 接触电阻 Contact resistance: 20mΩ max  
 绝缘电阻 Insulation resistance: 1000MΩ min  
 耐压 Withstand voltage: 1500V AC/minute  
 环境温度 Ambient temperature: -35°C~+105°C  
 适用线规 Wire range: AWG#28~#14

**标准/Standard:**



详细参数请咨询:

- E-mail: manager@zjdll.com
- E-mail: technical-support@zjdll.com
- WeChat: 13867778918

**PC电路板布局和组件布局 PC board layout and Assembly layout**

▣ Assembly layout (装配布局)

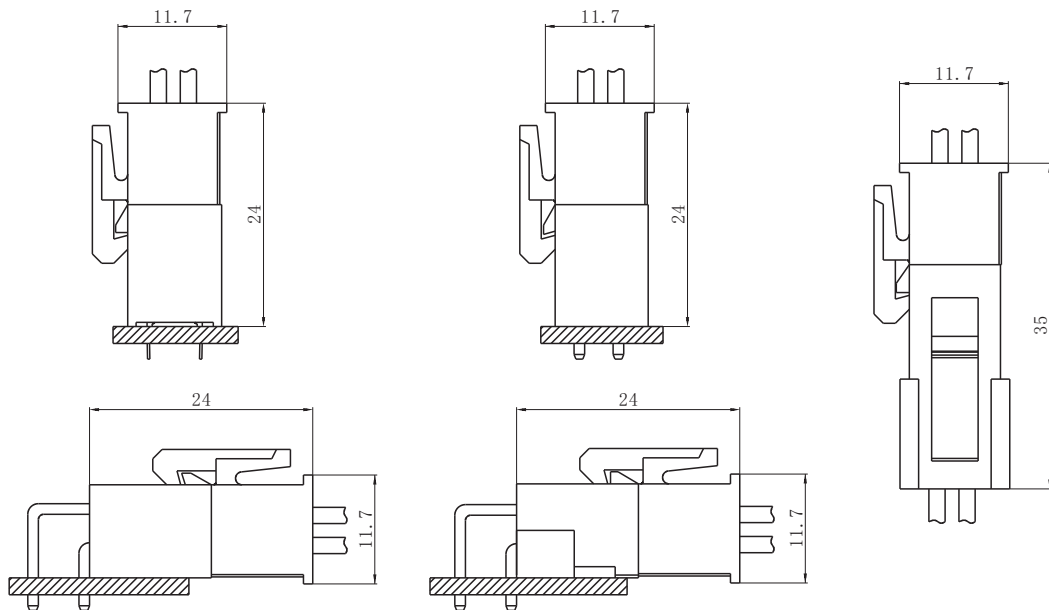

上图为连接器安装侧观察图

Notes: The above figure is the figure viewed from the connector mounting side.

DL42002-T (DLL-5556-T)



DL42002-RT (DLL-5558-RT)



Model No. (型号)	Applicable wire (适用线规)			Material (材料)	Plating (电镀)	Qty/reel (数量/盘)
	mm <sup>2</sup>	AWG#	Insulation O.D. (绝缘外径mm)			
DL42002-T (DLL-5556-T)	0.20~0.82	24~18	φ 1.5~2.1	Phosphor bronze (磷青铜)	Tin Plated (镀锡)	5000
DL42002-T-02 (DLL-5556-T-02)	0.08~0.20	28~24	φ 0.9~1.5	Phosphor bronze (磷青铜)	Tin Plated (镀锡)	6500
DL42002-T-03 (DLL-5556-T-03)	0.52~1.30	20~16	φ 1.8~2.7	Phosphor bronze (磷青铜)	Tin Plated (镀锡)	3500
DL42002-T-04 (DLL-5556-T-04)	0.82~2.08	18~14	φ 2.1~3.4	Phosphor bronze (磷青铜)	Tin Plated (镀锡)	3500
DL42002-T-GOLD (DLL-5556-T-GOLD)	0.20~0.82	24~18	φ 1.5~2.1	Phosphor bronze (磷青铜)	Gold Plated (镀金)	5000
DL42002-T-03-GOLD (DLL-5556-T-03-GOLD)	0.52~1.30	20~16	φ 1.8~2.7	Phosphor bronze (磷青铜)	Gold Plated (镀金)	3500
DL42002-RT (DLL-5558-RT)	0.08~0.20	28~24	φ 0.9~1.5	Phosphor bronze (磷青铜)	Tin Plated (镀锡)	5000
DL42002-RT-01 (DLL-5558-RT-01)	0.08~0.82	28~18	φ 0.9~2.1	Phosphor bronze (磷青铜)	Tin Plated (镀锡)	5000
DL42002-RT-GOLD (DLL-5558-RT-GOLD)	0.08~0.20	28~24	φ 0.9~1.5	Phosphor bronze (磷青铜)	Gold Plated (镀金)	5000
DL42002-RT-01-GOLD (DLL-5558-RT-01-GOLD)	0.08~0.82	28~18	φ 0.9~2.1	Phosphor bronze (磷青铜)	Gold Plated (镀金)	5000

符合RoHS标准  
RoHS compliance

DL42002-Y (DLL-5557-Y)



Circuits (电路)	Product name (产品名称)		Dimensions (尺寸mm)	
	A	B	A	B
2X1	DLL-5557-2Y	DLL-5557-2Y-V0	/	5.40
2X2	DLL-5557-4Y	DLL-5557-4Y-V0	4.20	9.60
2X3	DLL-5557-6Y	DLL-5557-6Y-V0	8.40	13.80
2X4	DLL-5557-8Y	DLL-5557-8Y-V0	12.60	18.00
2X5	DLL-5557-10Y	DLL-5557-10Y-V0	16.80	22.20
2X6	DLL-5557-12Y	DLL-5557-12Y-V0	21.00	26.40
2X7	DLL-5557-14Y	DLL-5557-14Y-V0	25.20	30.60
2X8	DLL-5557-16Y	DLL-5557-16Y-V0	29.40	34.80
2X9	DLL-5557-18Y	DLL-5557-18Y-V0	33.60	39.00
2X10	DLL-5557-20Y	DLL-5557-20Y-V0	37.80	43.20
2X11	DLL-5557-22Y	DLL-5557-22Y-V0	42.00	47.40
2X12	DLL-5557-24Y	DLL-5557-24Y-V0	46.20	51.60
2X13	DLL-5557-26Y	DLL-5557-26Y-V0	50.40	55.80
2X14	DLL-5557-28Y	DLL-5557-28Y-V0	54.60	60.00
2X15	DLL-5557-30Y	DLL-5557-30Y-V0	58.80	64.20

Material (材料)

Housing (胶壳): Nylon (尼龙) UL94V-0 (2)

符合RoHS标准  
RoHS compliance

DL42012-Y-FS (DLL-5557-Y-FS)



Circuits (电路)	Product name (产品名称)	Dimensions (尺寸mm)	
		A	B
2X1	DLL-5557-2Y-FS	/	8.00
2X2	DLL-5557-4Y-FS	4.20	12.20
2X3	DLL-5557-6Y-FS	8.40	16.40
2X4	DLL-5557-8Y-FS	12.60	20.60
2X5	DLL-5557-10Y-FS	16.80	24.80
2X6	DLL-5557-12Y-FS	21.00	29.00
2X7	DLL-5557-14Y-FS	25.20	33.20
2X8	DLL-5557-16Y-FS	29.40	37.40
2X9	DLL-5557-18Y-FS	33.60	41.60
2X10	DLL-5557-20Y-FS	37.80	45.80
2X11	DLL-5557-22Y-FS	42.00	50.00
2X12	DLL-5557-24Y-FS	46.20	54.20
2X13	DLL-5557-26Y-FS	50.40	58.40
2X14	DLL-5557-28Y-FS	54.60	62.60
2X15	DLL-5557-30Y-FS	58.80	66.80

Material (材料)

Housing (胶壳): Nylon (尼龙) UL94V-0

Lock (锁扣): Nylon (尼龙) UL94V-0 (2)

Waterproof pad (防水垫): Silicon rubber (硅橡胶)

符合RoHS标准  
RoHS compliance

DL42004-ABZ (DLL-5569-ABZ)



Circuits (电路)	Product name (产品名称)	Dimensions (尺寸mm)	
		A	B
2X2	DLL-5569-4ABZ	4.20	9.60
2X3	DLL-5569-6ABZ	8.40	13.80
2X4	DLL-5569-8ABZ	12.60	18.00
2X5	DLL-5569-10ABZ	16.80	22.20
2X6	DLL-5569-12ABZ	21.00	26.40
2X7	DLL-5569-14ABZ	25.20	30.60
2X8	DLL-5569-16ABZ	29.40	34.80
2X9	DLL-5569-18ABZ	33.60	39.00
2X10	DLL-5569-20ABZ	37.80	43.20
2X11	DLL-5569-22ABZ	42.00	47.40
2X12	DLL-5569-24ABZ	46.20	51.60
2X13	DLL-5569-26ABZ	50.40	55.80
2X14	DLL-5569-28ABZ	54.60	60.00
2X15	DLL-5569-30ABZ	58.80	64.20

Material (材料)

Housing (胶壳): LCP UL94V-0

Wafer (接触件): Brass (黄铜) / Tin plated (镀锡)

符合RoHS标准  
RoHS compliance

DL42004-A (DLL-5569-A)

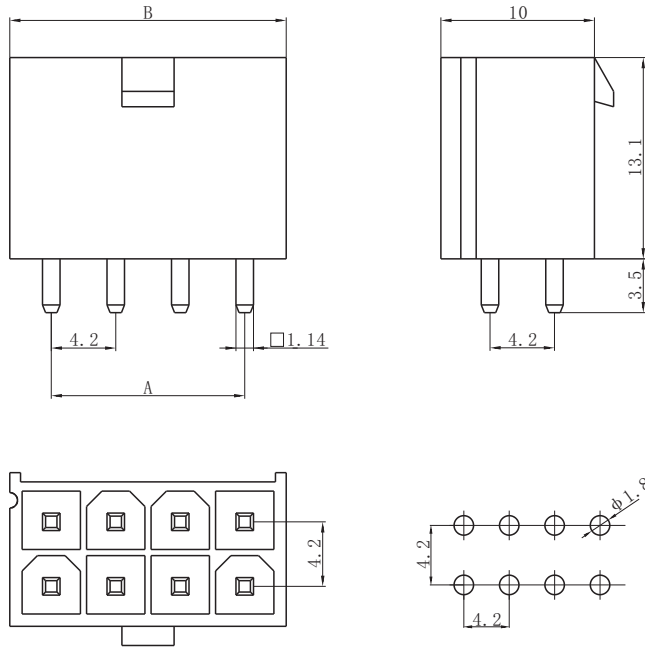

Circuits (电路)	Product name (产品名称)		Dimensions (尺寸mm)	
			A	B
2X1	DLL-5569-2A	DLL-5569-2A-GOLD	/	5.40
2X2	DLL-5569-4A	DLL-5569-4A-GOLD	4.20	9.60
2X3	DLL-5569-6A	DLL-5569-6A-GOLD	8.40	13.80
2X4	DLL-5569-8A	DLL-5569-8A-GOLD	12.60	18.00
2X5	DLL-5569-10A	DLL-5569-10A-GOLD	16.80	22.20
2X6	DLL-5569-12A	DLL-5569-12A-GOLD	21.00	26.40
2X7	DLL-5569-14A	DLL-5569-14A-GOLD	25.20	30.60
2X8	DLL-5569-16A	DLL-5569-16A-GOLD	29.40	34.80
2X9	DLL-5569-18A	DLL-5569-18A-GOLD	33.60	39.00
2X10	DLL-5569-20A	DLL-5569-20A-GOLD	37.80	43.20
2X11	DLL-5569-22A	DLL-5569-22A-GOLD	42.00	47.40
2X12	DLL-5569-24A	DLL-5569-24A-GOLD	46.20	51.60
2X13	DLL-5569-26A	DLL-5569-26A-GOLD	50.40	55.80
2X14	DLL-5569-28A	DLL-5569-28A-GOLD	54.60	60.00
2X15	DLL-5569-30A	DLL-5569-30A-GOLD	58.80	64.20

Material (材料)

Housing (胶壳): Nylon (尼龙) UL94V-0 (2)

Wafer (接触件): Brass (黄铜) / Tin plated (镀锡) / Gold plated (镀金)

符合RoHS标准  
RoHS compliance

DL42004-AW (DLL-5569-AW)

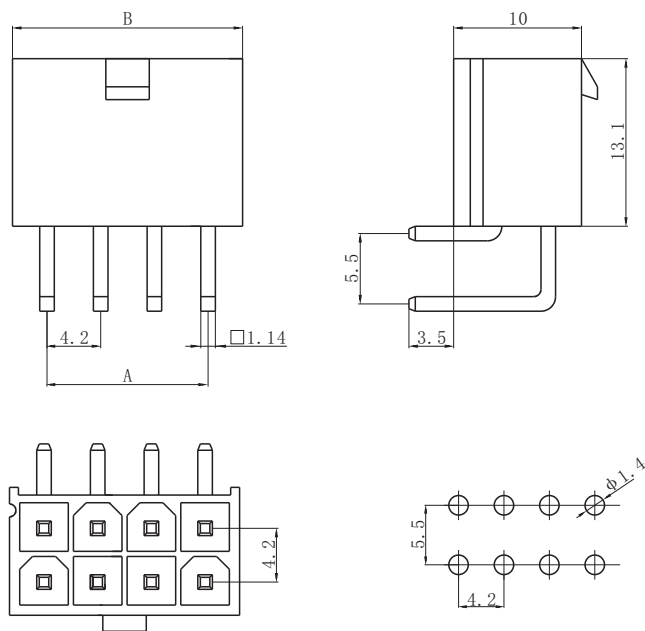

Circuits (电路)	Product name (产品名称)		Dimensions (尺寸mm)	
			A	B
2X1	DLL-5569-2AW	DLL-5569-2AW-GOLD	/	5.40
2X2	DLL-5569-4AW	DLL-5569-4AW-GOLD	4.20	9.60
2X3	DLL-5569-6AW	DLL-5569-6AW-GOLD	8.40	13.80
2X4	DLL-5569-8AW	DLL-5569-8AW-GOLD	12.60	18.00
2X5	DLL-5569-10AW	DLL-5569-10AW-GOLD	16.80	22.20
2X6	DLL-5569-12AW	DLL-5569-12AW-GOLD	21.00	26.40
2X7	DLL-5569-14AW	DLL-5569-14AW-GOLD	25.20	30.60
2X8	DLL-5569-16AW	DLL-5569-16AW-GOLD	29.40	34.80
2X9	DLL-5569-18AW	DLL-5569-18AW-GOLD	33.60	39.00
2X10	DLL-5569-20AW	DLL-5569-20AW-GOLD	37.80	43.20
2X11	DLL-5569-22AW	DLL-5569-22AW-GOLD	42.00	47.40
2X12	DLL-5569-24AW	DLL-5569-24AW-GOLD	46.20	51.60
2X13	DLL-5569-26AW	DLL-5569-26AW-GOLD	50.40	55.80
2X14	DLL-5569-28AW	DLL-5569-28AW-GOLD	54.60	60.00
2X15	DLL-5569-30AW	DLL-5569-30AW-GOLD	58.80	64.20

Material (材料)

Housing (胶壳): Nylon (尼龙) UL94V-0 (2)

Wafer (接触件): Brass (黄铜) / Tin plated (镀锡) / Gold plated (镀金)

符合RoHS标准  
RoHS compliance

DL42004-AW (DLL-5569-AW)

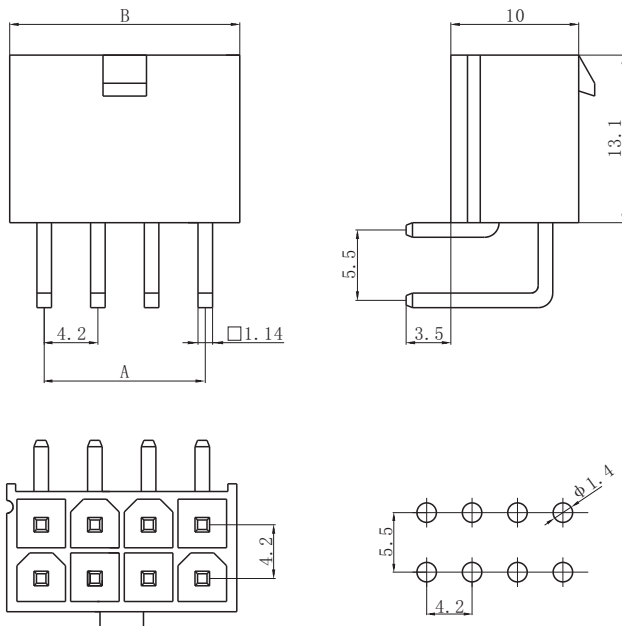

Circuits (电路)	Product name (产品名称)	Dimensions (尺寸mm)	
		A	B
2X1	DLL-5569-2AW-GOLD-YE	/	5.40
2X1	DLL-5569-2AW-GOLD-OR	/	5.40
2X1	DLL-5569-2AW-GOLD-GR	/	5.40
2X1	DLL-5569-2AW-GOLD-BL	/	5.40
2X3	DLL-5569-6AW-GOLD-GR	21.00	26.40
2X3	DLL-5569-6AW-GOLD-YE	21.00	26.40
2X3	DLL-5569-6AW-GOLD-BK	21.00	26.40
2X3	DLL-5569-6AW-GOLD-RE	21.00	26.40

Material (材料)

Housing (胶壳): Nylon (尼龙) UL94V-0 (2)

Wafer (接触件): Brass (黄铜) / Gold plated (镀金)

符合RoHS标准  
RoHS compliance

DL42004-AWS (DLL-5569-AWS)

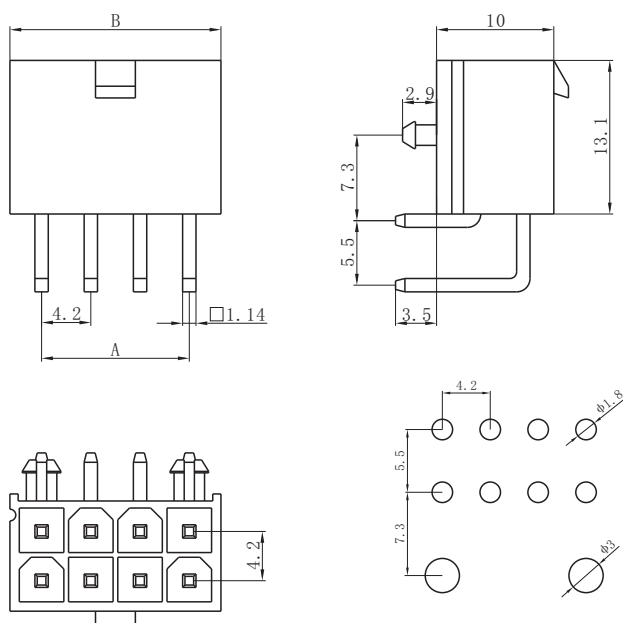

Circuits (电路)	Product name (产品名称)	Dimensions (尺寸mm)	
		A	B
2X1	DLL-5569-2AWS	/	5.40
2X2	DLL-5569-4AWS	4.20	9.60
2X3	DLL-5569-6AWS	8.40	13.80
2X4	DLL-5569-8AWS	12.60	18.00
2X5	DLL-5569-10AWS	16.80	22.20
2X6	DLL-5569-12AWS	21.00	26.40
2X7	DLL-5569-14AWS	25.20	30.60
2X8	DLL-5569-16AWS	29.40	34.80
2X9	DLL-5569-18AWS	33.60	39.00
2X10	DLL-5569-20AWS	37.80	43.20
2X11	DLL-5569-22AWS	42.00	47.40
2X12	DLL-5569-24AWS	46.20	51.60
2X13	DLL-5569-26AWS	50.40	55.80
2X14	DLL-5569-28AWS	54.60	60.00
2X15	DLL-5569-30AWS	58.80	64.20

Material (材料)

Housing (胶壳): Nylon (尼龙) UL94V-0 (2)

Wafer (接触件): Brass (黄铜) / Tin plated (镀锡)

符合RoHS标准  
RoHS compliance

DL42005-AW (DLL-5569F-AW)

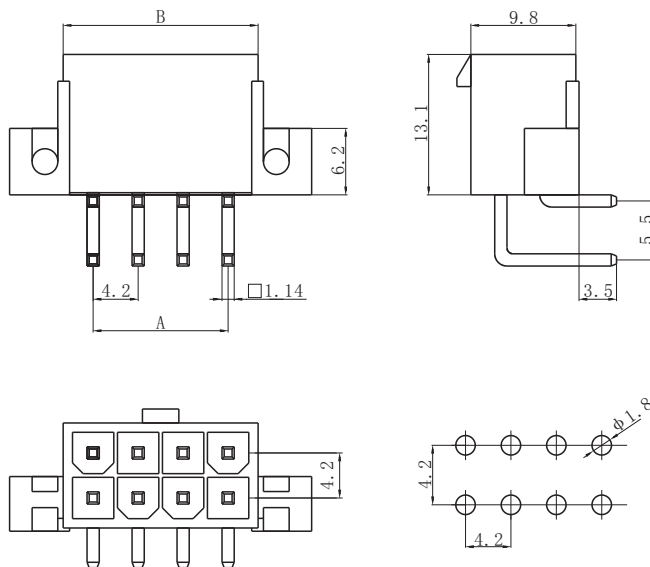

Circuits (电路)	Product name (产品名称)	Dimensions (尺寸mm)	
		A	B
2X1	DLL-5569F-2AW	/	5.40
2X2	DLL-5569F-4AW	4.20	9.60
2X3	DLL-5569F-6AW	8.40	13.80
2X4	DLL-5569F-8AW	12.60	18.00
2X5	DLL-5569F-10AW	16.80	22.20
2X6	DLL-5569F-12AW	21.00	26.40
2X7	DLL-5569F-14AW	25.20	30.60
2X8	DLL-5569F-16AW	29.40	34.80
2X9	DLL-5569F-18AW	33.60	39.00
2X10	DLL-5569F-20AW	37.80	43.20
2X11	DLL-5569F-22AW	42.00	47.40
2X12	DLL-5569F-24AW	46.20	51.60
2X13	DLL-5569F-26AW	50.40	55.80
2X14	DLL-5569F-28AW	54.60	60.00
2X15	DLL-5569F-30AW	58.80	64.20

Material (材料)

Housing (胶壳): Nylon (尼龙) UL94V-0 (2)

Wafer (接触件): Brass (黄铜) / Tin plated (镀锡)

符合RoHS标准  
RoHS compliance

DL42003-A (DLL-5566-A)

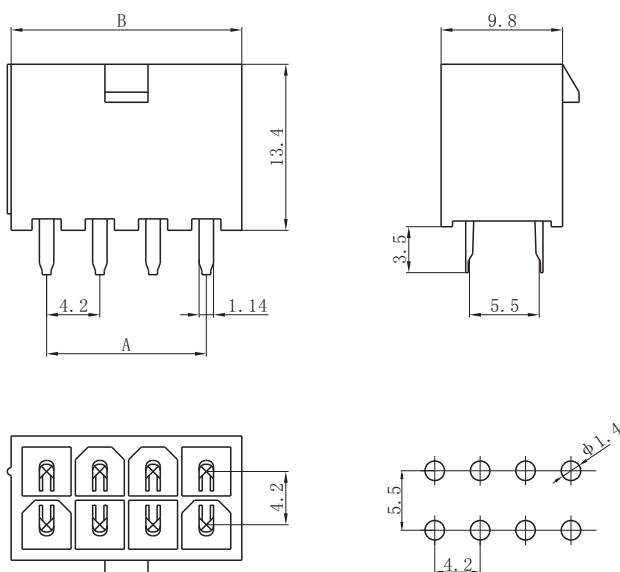

Circuits (电路)	Product name (产品名称)	Dimensions (尺寸mm)	
		A	B
2X1	DLL-5566-2A	/	5.40
2X2	DLL-5566-4A	4.20	9.60
2X3	DLL-5566-6A	8.40	13.80
2X4	DLL-5566-8A	12.60	18.00
2X5	DLL-5566-10A	16.80	22.20
2X6	DLL-5566-12A	21.00	26.40
2X7	DLL-5566-14A	25.20	30.60
2X8	DLL-5566-16A	29.40	34.80
2X9	DLL-5566-18A	33.60	39.00
2X10	DLL-5566-20A	37.80	43.20
2X11	DLL-5566-22A	42.00	47.40
2X12	DLL-5566-24A	46.20	51.60
2X13	DLL-5566-26A	50.40	55.80
2X14	DLL-5566-28A	54.60	60.00
2X15	DLL-5566-30A	58.80	64.20

Material (材料)

Housing (胶壳): Nylon (尼龙) UL94V-0 (2)

Wafer (接触件): Phosphor bronze (磷青铜) / Tin plated (镀锡)

符合RoHS标准  
RoHS compliance

DL42003-AS (DLL-5566-AS)

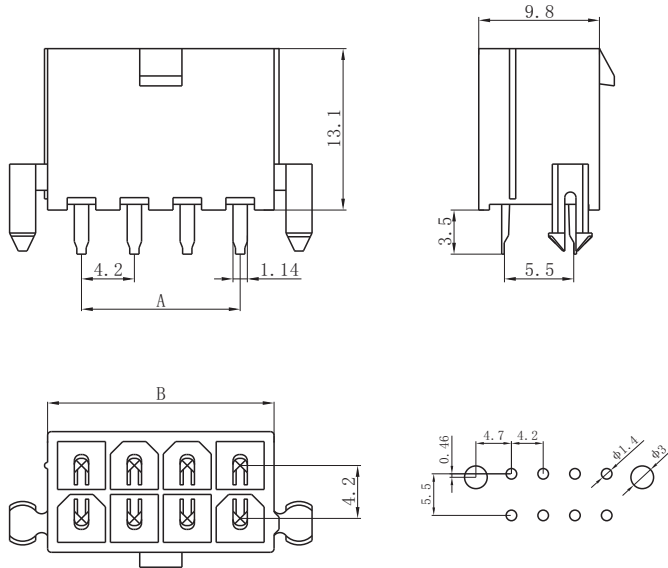

Circuits (电路)	Product name (产品名称)	Dimensions (尺寸mm)	
		A	B
2X1	DLL-5566-2AS	/	5.40
2X2	DLL-5566-4AS	4.20	9.60
2X3	DLL-5566-6AS	8.40	13.80
2X4	DLL-5566-8AS	12.60	18.00
2X5	DLL-5566-10AS	16.80	22.20
2X6	DLL-5566-12AS	21.00	26.40
2X7	DLL-5566-14AS	25.20	30.60
2X8	DLL-5566-16AS	29.40	34.80
2X9	DLL-5566-18AS	33.60	39.00
2X10	DLL-5566-20AS	37.80	43.20
2X11	DLL-5566-22AS	42.00	47.40
2X12	DLL-5566-24AS	46.20	51.60
2X13	DLL-5566-26AS	50.40	55.80
2X14	DLL-5566-28AS	54.60	60.00
2X15	DLL-5566-30AS	58.80	64.20

Material (材料)

Housing (胶壳): Nylon (尼龙) UL94V-0 (2)

Wafer (接触件): Phosphor bronze (磷青铜) / Tin plated (镀锡)

符合RoHS标准  
RoHS compliance

DL42002-R (DLL-5559-R)

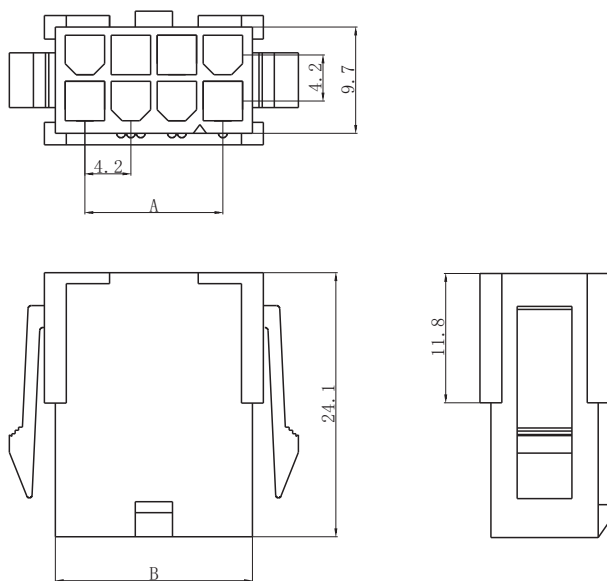

Circuits (电路)	Product name (产品名称)	Dimensions (尺寸mm)		
		A	B	
2X1	DLL-5559-2R	DLL-5559-2R-V0	/	5.60
2X2	DLL-5559-4R	DLL-5559-4R-V0	4.20	9.80
2X3	DLL-5559-6R	DLL-5559-6R-V0	8.40	14.00
2X4	DLL-5559-8R	DLL-5559-8R-V0	12.60	18.20
2X5	DLL-5559-10R	DLL-5559-10R-V0	16.80	22.40
2X6	DLL-5559-12R	DLL-5559-12R-V0	21.00	26.60
2X7	DLL-5559-14R	DLL-5559-14R-V0	25.20	30.80
2X8	DLL-5559-16R	DLL-5559-16R-V0	29.40	35.00
2X9	DLL-5559-18R	DLL-5559-18R-V0	33.60	39.20
2X10	DLL-5559-20R	DLL-5559-20R-V0	37.80	43.40
2X11	DLL-5559-22R	DLL-5559-22R-V0	42.00	47.60
2X12	DLL-5559-24R	DLL-5559-24R-V0	46.20	51.80
2X13	DLL-5559-26R	DLL-5559-26R-V0	50.40	56.00
2X14	DLL-5559-28R	DLL-5559-28R-V0	54.60	60.20
2X15	DLL-5559-30R	DLL-5559-30R-V0	58.80	64.40

Material (材料)

Housing (胶壳): Nylon (尼龙) UL94V-0 (2)

符合RoHS标准  
RoHS compliance

□ DL42002-RF (DLL-5559-RF)

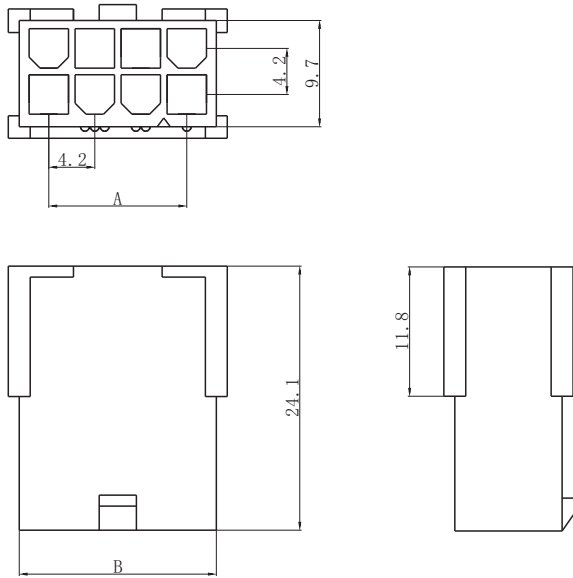

Circuits (电路)	Product name (产品名称)	Dimensions (尺寸mm)	
		A	B
2X1	DLL-5559-2RF	/	5.60
2X2	DLL-5559-4RF	4.20	9.80
2X3	DLL-5559-6RF	8.40	14.00
2X4	DLL-5559-8RF	12.60	18.20
2X5	DLL-5559-10RF	16.80	22.40
2X6	DLL-5559-12RF	21.00	26.60
2X7	DLL-5559-14RF	25.20	30.80
2X8	DLL-5559-16RF	29.40	35.00
2X9	DLL-5559-18RF	33.60	39.20
2X10	DLL-5559-20RF	37.80	43.40
2X11	DLL-5559-22RF	42.00	47.60
2X12	DLL-5559-24RF	46.20	51.80
2X13	DLL-5559-26RF	50.40	56.00
2X14	DLL-5559-28RF	54.60	60.20
2X15	DLL-5559-30RF	58.80	64.40

Material (材料)

Housing (胶壳): Nylon (尼龙) UL94V-0 (2)

符合RoHS标准  
RoHS compliance

□ DL42002-RFF (DLL-5559-RFF)

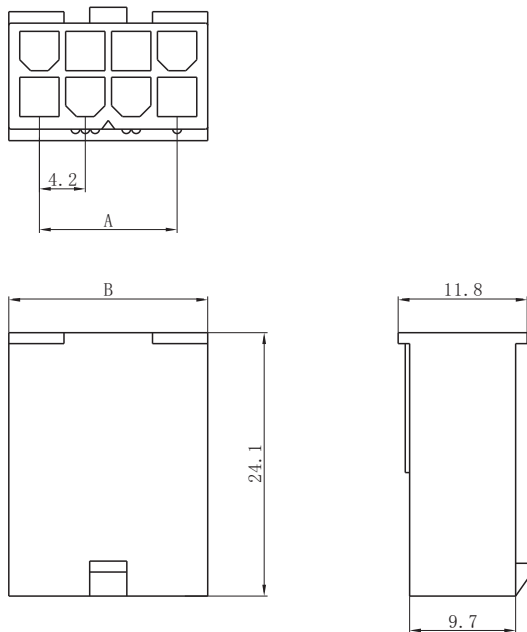

Circuits (电路)	Product name (产品名称)	Dimensions (尺寸mm)	
		A	B
2X1	DLL-5559-2RFF	/	5.60
2X2	DLL-5559-4RFF	4.20	9.80
2X3	DLL-5559-6RFF	8.40	14.00
2X4	DLL-5559-8RFF	12.60	18.20
2X5	DLL-5559-10RFF	16.80	22.40
2X6	DLL-5559-12RFF	21.00	26.60
2X7	DLL-5559-14RFF	25.20	30.80
2X8	DLL-5559-16RFF	29.40	35.00
2X9	DLL-5559-18RFF	33.60	39.20
2X10	DLL-5559-20RFF	37.80	43.40
2X11	DLL-5559-22RFF	42.00	47.60
2X12	DLL-5559-24RFF	46.20	51.80
2X13	DLL-5559-26RFF	50.40	56.00
2X14	DLL-5559-28RFF	54.60	60.20
2X15	DLL-5559-30RFF	58.80	64.40

Material (材料)

Housing (胶壳): Nylon (尼龙) UL94V-0 (2)

符合RoHS标准  
RoHS compliance



## X-ON Electronics

Largest Supplier of Electrical and Electronic Components

*Click to view similar products for [Headers & Wire Housings](#) category:*

*Click to view products by [DLL](#) manufacturer:*

Other Similar products are found below :

[0015917161](#) [0022155065](#) [57102-F02-18ULF](#) [58102-G61-06LF](#) [582553-1](#) [01.001.5753.1](#) [0050291907](#) [02.125.8002.8](#) [609-3404](#) [61062-3](#)  
[CSU011177004](#) [622-0430](#) [622-3653LF](#) [63453-116](#) [636-1030](#) [636-1427](#) [636-3427](#) [636-4007](#) [641938-9](#) [65495-038](#) [65692-001LF](#) [65781-018](#)  
[65781-047](#) [65817-010LF](#) [65817-015LF](#) [67095-007LF](#) [67601157](#) [68631-112](#) [68645-018](#) [699319-000](#) [70.362.1628.0](#) [70-4210](#) [70-4226B](#) [70-](#)  
[4853B](#) [71.350.2428.0](#) [733-134](#) [733-162](#) [760-3052](#) [MHR-64-VUAL](#) [80.063.4001.1](#) [800-90-001-10-001000](#) [801-43-002-10-013000](#)  
[801-43-006-10-002000](#) [803-43-024-10-001000](#) [803-93-012-10-001000](#) [8-1437020-4](#) [819-22-004-30-001101](#) [820-22-006-30-001101](#)  
[820-22-008-30-001101](#) [821-22-002-10-001101](#)