

技术特性/Specifications:

额定电压 Rated voltage: 250V AC, DC
额定电流 Rated current: 3A AC, DC
接触电阻 Contact resistance: 20m Ω max
绝缘电阻 Insulation resistance: 1000M Ω min
耐压 Withstand voltage: 800V AC/minute
环境温度 Ambient temperature: -40 $^{\circ}$ C~+105 $^{\circ}$ C
适用线规 Wire range: AWG#30~#20

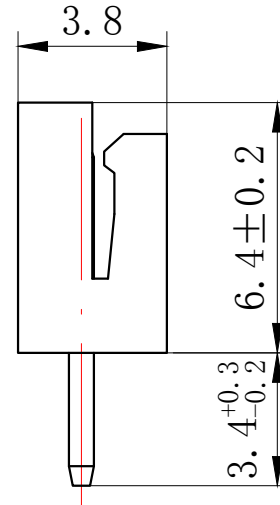

REV.	REVISION DESCRIPTION	DATE	APPD

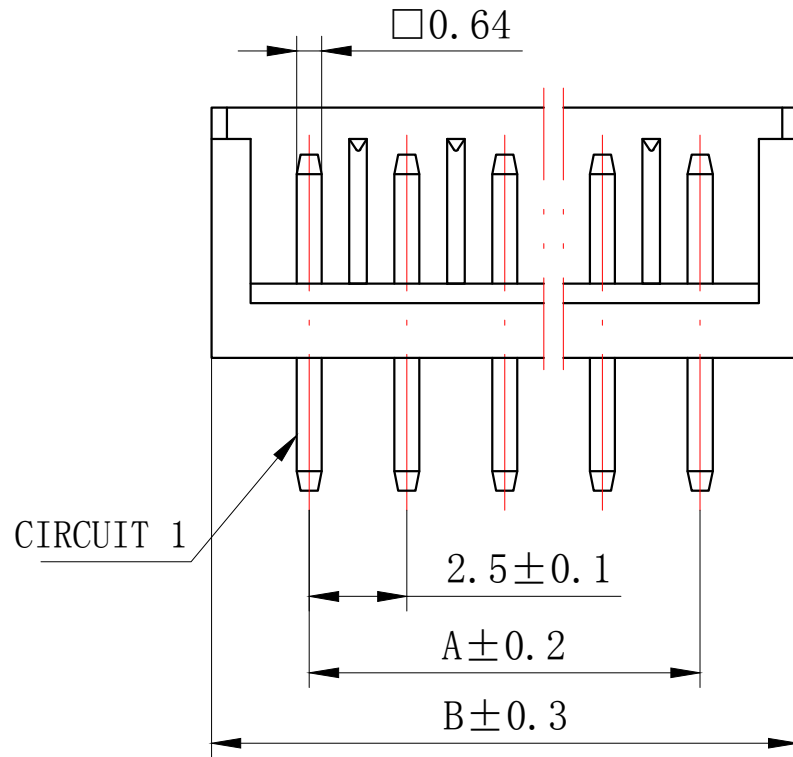

NORES:

1. Rated voltage: 250V AC/DC
2. Rated current: 3A AC/DC
3. Contact resistance: ≤ 20 mΩ
4. Insulation resistance: ≥ 1000 mΩ
5. Withstand voltage: 800V AC/minute
6. Ambient temperature: -40°C ~ 105°C
7. Materials: Nylon UL94V-0(2)
8. Matched RoHS criteria

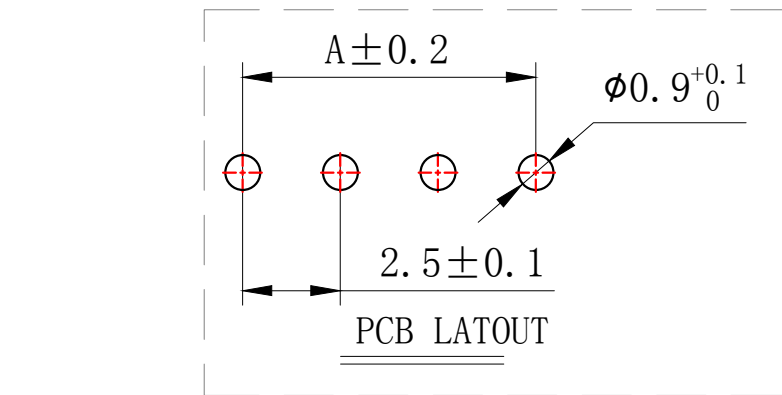

Circuits	Product Name	Dimension mm	
		A	B
2	EH-2A	2.5	7.5
3	EH-3A	5.0	10.0
4	EH-4A	7.5	12.5
5	EH-5A	10.0	15.0
6	EH-6A	12.5	17.5
7	EH-7A	15.0	20.0
8	EH-8A	17.5	22.5
9	EH-9A	20.0	25.0
10	EH-10A	22.5	27.5
~	~	~	~
15	EH-15A	35.0	40.0

GENERAL TOLERANCES (UNLESS SPECIFIED)		ZHE JIANG DELI CONNECTORS CO., LTD	
.X: ± 0.25	X°: ± 3.0°	PRODUCT NAME:	TITLE: 2.50 mm Pitch Wire To Board Wafer
.XX: ± 0.15	.X°: ± 2.0°	DL25011 (EH)-A	
.XXX: ± 0.01	.XX°: ± 1.0°	DR: Yuan Jun Rong	DATE: 21/08/01
FINISH:		CHKD: Wu Hui	DATE: 21/08/01
DRAWING NO:		APPD: Ren An De	DATE: 21/08/01
		SCALE: N/A	PAGE: 1/1
		UNITS: mm	REV.: A

REV.	REVISION DESCRIPTION	DATE	APPD

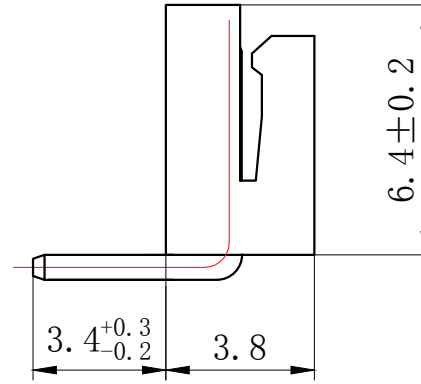
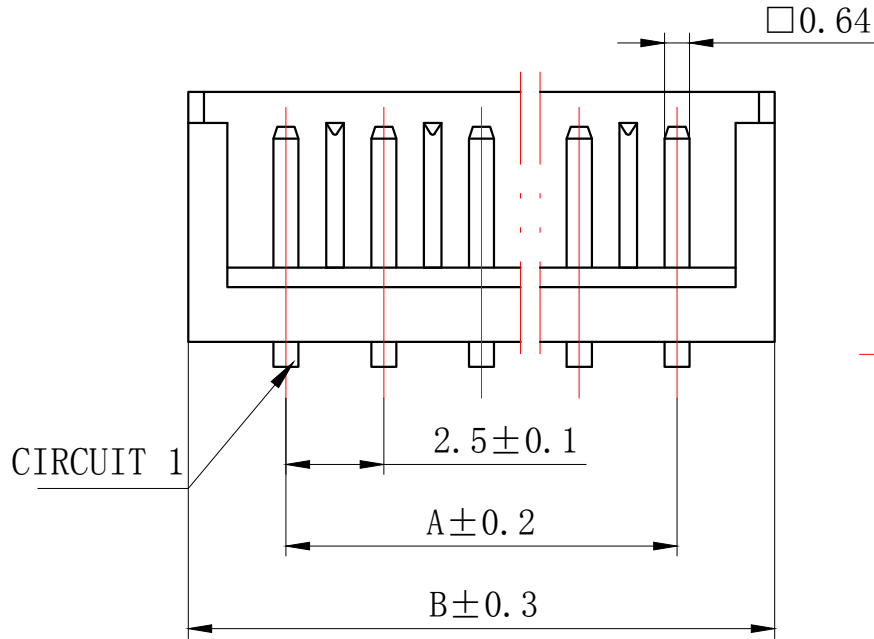

NORES:

1. Rated voltage: 250V AC/DC
2. Rated current: 3A AC/DC
3. Contact resistance: ≤ 20 m Ω
4. Insulation resistance: ≥ 1000 m Ω
5. Withstand voltage: 800V AC/minute
6. Ambient temperature: $-40^{\circ}\text{C} \sim 105^{\circ}\text{C}$
7. Materials: Nylon UL94V-0(2)
8. Matched RoHS criteria

Circuits	Product Name	Dimension mm	
		A	B
2	EH-2AW	2.5	7.5
3	EH-3AW	5.0	10.0
4	EH-4AW	7.5	12.5
5	EH-5AW	10.0	15.0
6	EH-6AW	12.5	17.5
7	EH-7AW	15.0	20.0
8	EH-8AW	17.5	22.5
9	EH-9AW	20.0	25.0
10	EH-10AW	22.5	27.5
~	~	~	~
15	EH-15AW	35.0	40.0

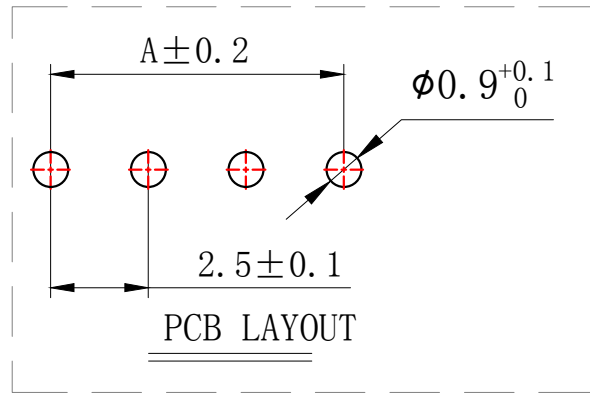

GENERAL TOLERANCES (UNLESS SPECIFIED)		ZHE JIANG DELI CONNECTORS CO., LTD	
.X: ± 0.25	X°: $\pm 3.0^{\circ}$	PRODUCT NAME: DL25011 (EH)-AW	TITLE: 2.50 mm Pitch Wire To Board Wafer
.XX: ± 0.15	.X°: $\pm 2.0^{\circ}$	DR: Yuan Jun Rong	DATE: 21/08/01
.XXX: ± 0.01	.XX°: $\pm 1.0^{\circ}$	CHKD: Wu Hui	DATE: 21/08/01
FINISH: _____		APPD: Ren An De	DATE: 21/08/01
DRAWING NO:		SCALE: N/A	PAGE: 1/1
		UNITS: mm	REV.: A

REV.	REVISION DESCRIPTION	DATE	APPD



NORES:

1. Rated voltage: 250V AC/DC
2. Rated current: 3A AC/DC
3. Contact resistance: ≤ 20 m Ω
4. Insulation resistance: ≥ 1000 m Ω
5. Withstand voltage: 800V AC/minute
6. Ambient temperature: $-40^{\circ}\text{C} \sim 105^{\circ}\text{C}$
7. Materials: Nylon UL94V-0(2)
8. Matched RoHS criteria

Circuits	Product Name	Dimension mm	
		A	B
2	EH-2AWD	2.5	7.5
3	EH-3AWD	5.0	10.0
4	EH-4AWD	7.5	12.5
5	EH-5AWD	10.0	15.0
6	EH-6AWD	12.5	17.5
7	EH-7AWD	15.0	20.0
8	EH-8AWD	17.5	22.5
9	EH-9AWD	20.0	25.0
10	EH-10AWD	22.5	27.5
~	~	~	~
15	EH-15AWD	35.0	40.0



GENERAL TOLERANCES (UNLESS SPECIFIED)		ZHE JIANG DELI CONNECTORS CO., LTD	
.X: ± 0.25	X°: $\pm 3.0^{\circ}$	PRODUCT NAME: DL25011 (EH)-AWD	TITLE: 2.50 mm Pitch Wire To Board Wafer
.XX: ± 0.15	.X°: $\pm 2.0^{\circ}$	DR: Yuan Jun Rong	DATE: 21/08/01
.XXX: ± 0.01	.XX°: $\pm 1.0^{\circ}$	CHKD: Wu Hui	DATE: 21/08/01
DRAWING NO:		APPD: Ren An De	DATE: 21/08/01
		SCALE: N/A	PAGE: 1/1
		UNITS: mm	REV.: A

REV.	REVISION DESCRIPTION	DATE	APPD



NORES:

1. Rated voltage: 250V AC/DC
2. Rated current: 3A AC/DC
3. Contact resistance: $\leq 20 \text{ m}\Omega$
4. Insulation resistance: $\geq 1000 \text{ m}\Omega$
5. Withstand voltage: 800V AC/minute
6. Ambient temperature: $-40^\circ\text{C} \sim 105^\circ\text{C}$
7. Materials: Nylon UL94V-0(2)
8. Matched RoHS criteria



Circuits	Product Name	Dimension mm	
		A	B
2	EH-2AWD-2	2.5	7.5
3	EH-3AWD-2	5.0	10.0
4	EH-4AWD-2	7.5	12.5
5	EH-5AWD-2	10.0	15.0
6	EH-6AWD-2	12.5	17.5
7	EH-7AWD-2	15.0	20.0
8	EH-8AWD-2	17.5	22.5
9	EH-9AWD-2	20.0	25.0
10	EH-10AWD-2	22.5	27.5
~	~	~	~
15	EH-15AWD-2	35.0	40.0

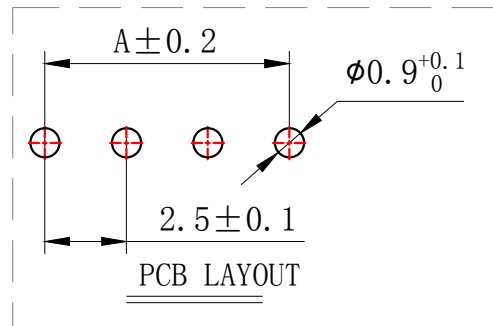

GENERAL TOLERANCES (UNLESS SPECIFIED)		ZHE JIANG DELI CONNECTORS CO., LTD	
.X: ± 0.25	X°: ± 3.0°	PRODUCT NAME: DL25011 (EH)-AWD-2	TITLE: 2.50 mm Pitch Wire To Board Wafer
.XX: ± 0.15	.X°: ± 2.0°	DR: Yuan Jun Rong	DATE: 21/08/01
.XXX: ± 0.01	.XX°: ± 1.0°	CHKD: Wu Hui	DATE: 21/08/01
FINISH: _____		APPD: Ren An De	DATE: 21/08/01
DRAWING NO:		UNITS: mm	REV.: A

PART NO:	
SCALE: N/A	PAGE: 1/1

REV.	REVISION DESCRIPTION	DATE	APPD

NORES:

1. Rated voltage: 250V AC/DC
2. Rated current: 3A AC/DC
3. Contact resistance: $\leq 20 \text{ m}\Omega$
4. Insulation resistance: $\geq 1000 \text{ m}\Omega$
5. Withstand voltage: 800V AC/minute
6. Ambient temperature: $-40^{\circ}\text{C} \sim 105^{\circ}\text{C}$
7. Materials: Nylon UL94V-0(2)
8. Matched RoHS criteria

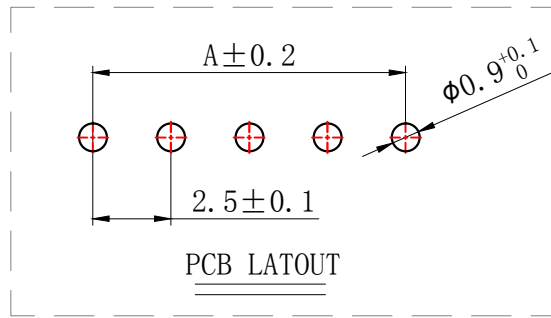
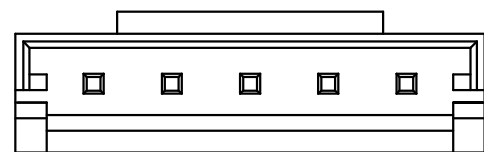
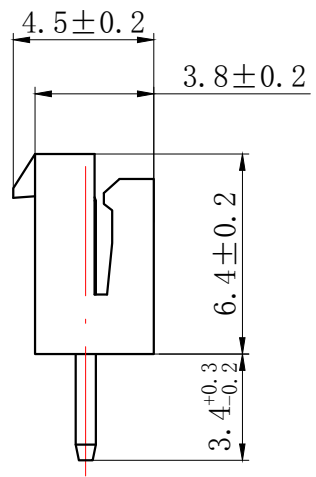
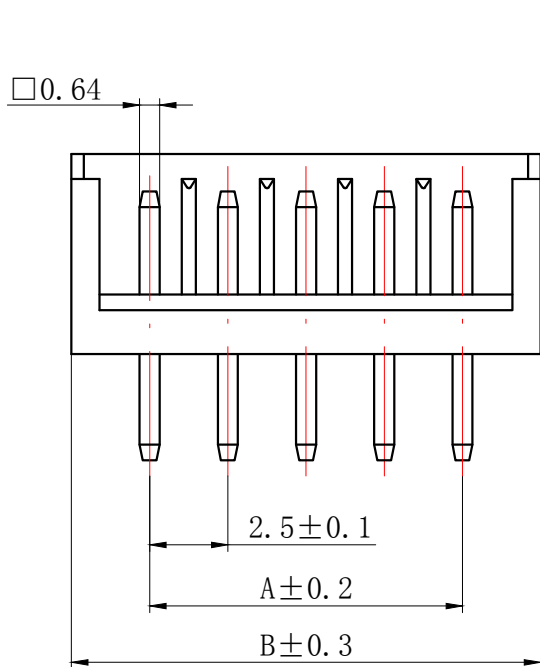

Circuits	Product Name	Dimension mm	
		A	B
2	EHB-2A	2.5	7.5
3	EHB-3A	5.0	10.0
4	EHB-4A	7.5	12.5
5	EHB-5A	10.0	15.0
6	EHB-6A	12.5	17.5
7	EHB-7A	15.0	20.0
8	EHB-8A	17.5	22.5
9	EHB-9A	20.0	25.0
10	EHB-10A	22.5	27.5
~	~	~	~
15	EHB-15A	35.0	40.0

GENERAL TOLERANCES (UNLESS SPECIFIED)		ZHE JIANG DELI CONNECTORS CO., LTD	
.X: ± 0.25	X°: $\pm 3.0^{\circ}$	PRODUCT NAME: DL25038 (EHB)-A	TITLE: 2.50 mm Pitch Wire To Board Wafer
.XX: ± 0.15	.X°: $\pm 2.0^{\circ}$	DR: Ke Xian Qiang	DATE: 19/08/01
.XXX: ± 0.01	.XX°: $\pm 1.0^{\circ}$	CHKD: Liu Bing	DATE: 19/08/01
FINISH:		APPD: Ren An De	DATE: 19/08/01
DRAWING NO:			
			PART NO:
			SCALE: N/A
			PAGE: 1/1
			UNITS: mm
			REV.: A

REV.	REVISION DESCRIPTION	DATE	APPD

NORES:

1. Rated voltage: 250V AC/DC
2. Rated current: 3A AC/DC
3. Contact resistance: $\leq 20 \text{ m}\Omega$
4. Insulation resistance: $\geq 1000 \text{ m}\Omega$
5. Withstand voltage: 800V AC/minute
6. Ambient temperature: $-40^{\circ}\text{C} \sim 105^{\circ}\text{C}$
7. Materials: Nylon UL94V-0(2)
8. Matched RoHS criteria



Circuits	Product Name	Dimension mm	
		A	B
2	EHB-2AS	2.5	7.5
3	EHB-3AS	5.0	10.0
4	EHB-4AS	7.5	12.5
5	EHB-5AS	10.0	15.0
6	EHB-6AS	12.5	17.5
7	EHB-7AS	15.0	20.0
8	EHB-8AS	17.5	22.5
9	EHB-9AS	20.0	25.0
10	EHB-10AS	22.5	27.5
~	~	~	~
15	EHB-15AS	35.0	40.0

GENERAL TOLERANCES (UNLESS SPECIFIED)		ZHE JIANG DELI CONNECTORS CO., LTD	
.X: ± 0.25	X°: ± 3.0°	PRODUCT NAME: DL25038 (EHB)-AS	TITLE: 2.50 mm Pitch Wire To Board Wafer
.XX: ± 0.15	.X°: ± 2.0°	DR: Ke Xian Qiang	DATE:19/08/01
.XXX: ± 0.01	.XX°: ± 1.0°	CHKD: Liu Bing	DATE:19/08/01
FINISH: _____		APPD: Ren An De	DATE:19/08/01
DRAWING NO:			PART NO:
			SCALE: N/A
			PAGE: 1/1
			UNITS: mm
			REV.: A

REV.	REVISION DESCRIPTION	DATE	APPD



NORES:

1. Rated voltage: 250V AC/DC
2. Rated current: 3A AC/DC
3. Contact resistance: $\leq 20 \text{ m}\Omega$
4. Insulation resistance: $\geq 1000 \text{ m}\Omega$
5. Withstand voltage: 800V AC/minute
6. Ambient temperature: $-40^\circ\text{C} \sim 105^\circ\text{C}$
7. Materials: Nylon UL94V-0(2)
8. Matched RoHS criteria

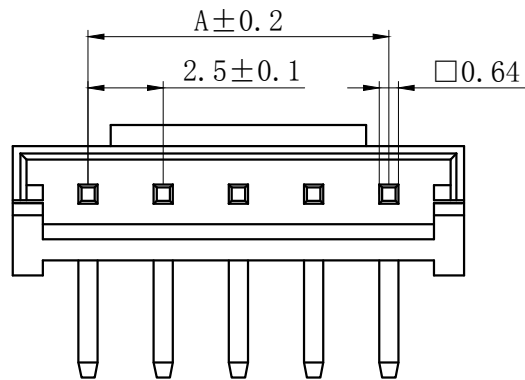

Circuits	Product Name	Dimension mm	
		A	B
2	EHB-2AWD	2.5	7.5
3	EHB-3AWD	5.0	10.0
4	EHB-4AWD	7.5	12.5
5	EHB-5AWD	10.0	15.0
6	EHB-6AWD	12.5	17.5
7	EHB-7AWD	15.0	20.0
8	EHB-8AWD	17.5	22.5
9	EHB-9AWD	20.0	25.0
10	EHB-10AWD	22.5	27.5
~	~	~	~
15	EHB-15AWD	35.0	40.0

GENERAL TOLERANCES (UNLESS SPECIFIED)		ZHE JIANG DELI CONNECTORS CO., LTD	
.X: ± 0.25	X°: ± 3.0°	PRODUCT NAME: DL25038 (EHB)-AWD	TITLE: 2.50 mm Pitch Wire To Board Wafer
.XX: ± 0.15	.X°: ± 2.0°	DR: Yuan Jun Rong	DATE:21/08/01
.XXX: ± 0.01	.XX°: ± 1.0°	CHKD: Wu Hui	DATE:21/08/01
FINISH:		APPD: Ren An De	DATE:21/08/01
DRAWING NO:			
			PART NO:
			SCALE: N/A
			PAGE: 1/1
			UNITS: mm
			REV.: A

REV.	REVISION DESCRIPTION	DATE	APPD

NOTES

Available in 02 through 15 Circuits.
Mates with DL25011/DL25038 Series Housing.
Material : Nylon UL94V-0(2).
Pin Material : Brass / Tin-Plated.



Circuits	Product name	Dimension mm			Circuits	Product name	Dimension mm		
		A	B	C			A	B	C
2	EH-2Y	2.50	7.00	5.40	9	EH-9Y	20.00	24.50	22.90
3	EH-3Y	5.00	9.50	7.90	10	EH-10Y	22.50	27.00	25.40
4	EH-4Y	7.50	12.00	10.40	11	EH-11Y	25.00	29.50	27.90
5	EH-5Y	10.00	14.50	12.90	12	EH-12Y	27.50	32.00	30.40
6	EH-6Y	12.50	17.00	15.40	13	EH-13Y	30.00	34.50	32.90
7	EH-7Y	15.00	19.50	17.90	14	EH-14Y	32.50	37.00	35.40
8	EH-8Y	17.50	22.00	20.40	15	EH-15Y	35.00	39.50	37.90

GENERAL TOLERANCES (UNLESS SPECIFIED)		ZHE JIANG DELI CONNECTORS CO., LTD	
.X: ± 0.25	X°: $\pm 3.0^\circ$	PRODUCT NAME:	TITLE:
.XX: ± 0.15	.X°: $\pm 2.0^\circ$	DL25011 (EH)-Y	2.50 mm Pitch Housing
.XXX: ± 0.01	.XX°: $\pm 1.0^\circ$	DR: Chen Quan Long	DATE: 21/08/01
FINISH:		CHKD: Wu Hui	DATE: 21/08/01
DRAWING NO:		APPD: Ren An De	DATE: 21/08/01
			PART NO:
			SCALE: N/A
			PAGE: 1/1
			UNITS: mm
			REV.: A

REV.	REVISION DESCRIPTION	DATE	APPD

NOTES

Used in DL25011-Y Series Housing.

Accepts AWG #30~22 Wire Range.

Insulation O.D.=1.0~1.9 mm.

Material : Phosphor Bronze .

Finish: Tin-plated.

Thickness: 0.2 mm.

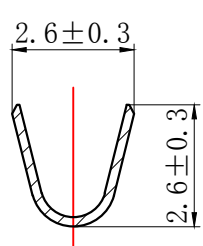
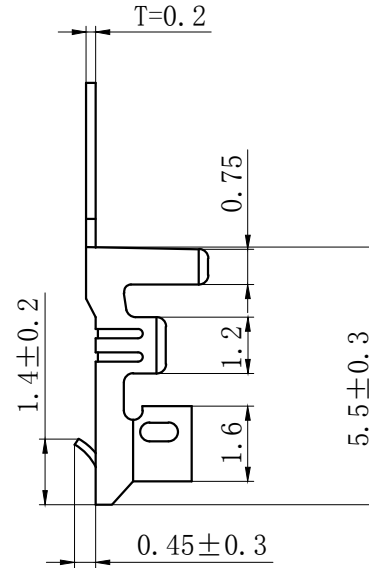
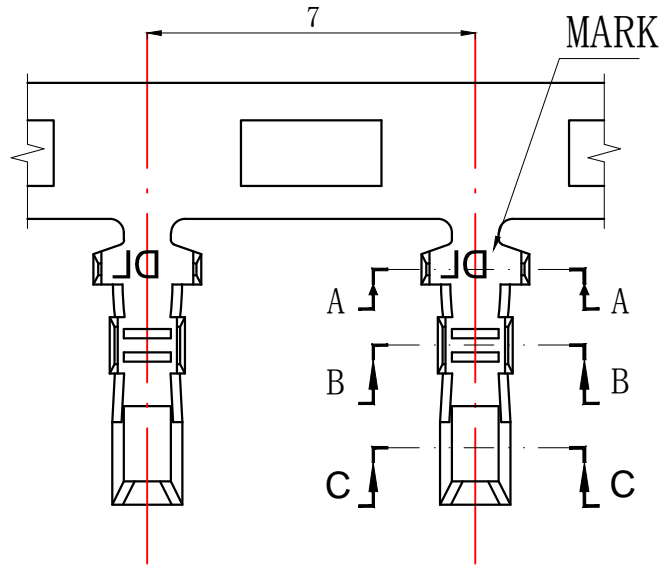

SECTION A-A

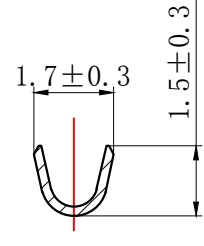

SECTION B-B

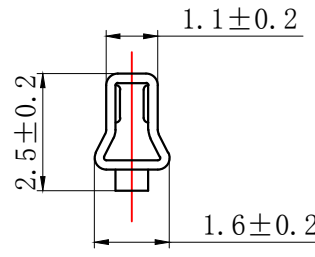

SECTION C-C

GENERAL TOLERANCES (UNLESS SPECIFIED)		ZHE JIANG DELI CONNECTORS CO., LTD	
.X: ± 0.25	X°: ± 3.0°	PRODUCT NAME:	TITLE:
.XX: ± 0.15	.X°: ± 2.0°	DL25011 (EH)-T	2.50 mm Pitch WTB Crimp Terminal
.XXX: ± 0.01	.XX°: ± 1.0°	DR: Chen Quan Long	DATE: 21/03/13
FINISH:		CHKD: Wu Hui	DATE: 21/03/13
DRAWING NO:		APPD: Ren An De	DATE: 21/03/13
			PART NO:
			SCALE: N/A
			PAGE: 1/1
			UNITS: mm
			REV.: A

X-ON Electronics

Largest Supplier of Electrical and Electronic Components

Click to view similar products for [Headers & Wire Housings](#) category:

Click to view products by [DLL](#) manufacturer:

Other Similar products are found below :

[0015917161](#) [0022155065](#) [57102-F02-18ULF](#) [58102-G61-06LF](#) [582553-1](#) [01.001.5753.1](#) [0050291907](#) [02.125.8002.8](#) [609-3404](#) [61062-3](#)
[CSU011177004](#) [622-0430](#) [622-3653LF](#) [63453-116](#) [636-1030](#) [636-1427](#) [636-3427](#) [636-4007](#) [641938-9](#) [65495-038](#) [65692-001LF](#) [65781-018](#)
[65781-047](#) [65817-010LF](#) [65817-015LF](#) [67095-007LF](#) [67601157](#) [68631-112](#) [68645-018](#) [699319-000](#) [70.362.1628.0](#) [70-4210](#) [70-4226B](#) [70-](#)
[4853B](#) [71.350.2428.0](#) [733-134](#) [733-162](#) [760-3052](#) [MHR-64-VUAL](#) [80.063.4001.1](#) [800-90-001-10-001000](#) [801-43-002-10-013000](#)
[801-43-006-10-002000](#) [803-43-024-10-001000](#) [803-93-012-10-001000](#) [8-1437020-4](#) [819-22-004-30-001101](#) [820-22-006-30-001101](#)
[820-22-008-30-001101](#) [821-22-002-10-001101](#)