

技术特性/Specifications:

额定电压 Rated voltage: 50V AC, DC
额定电流 Rated current: 1A AC, DC
接触电阻 Contact resistance: 20mΩ max
绝缘电阻 Insulation resistance: 100MΩ min
耐压 Withstand voltage: 500V AC/minute
环境温度 Ambient temperature: -40°C~+105°C
适用线规 Wire range: AWG#32~#28

REV.	REVISION DESCRIPTION	DATE

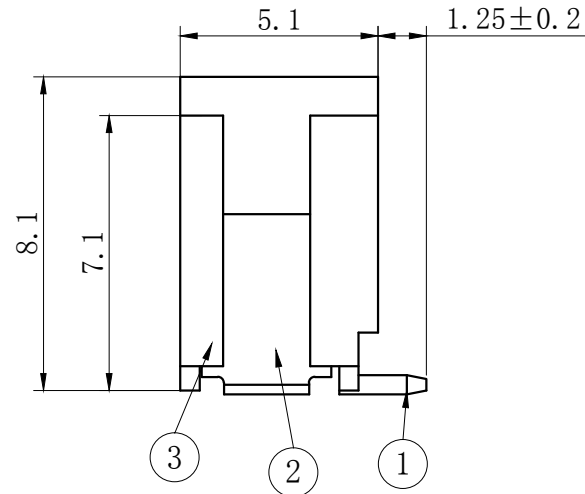
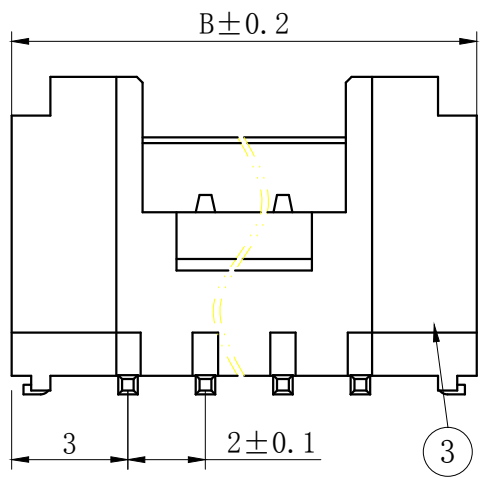

NOTES

Available in 02 through 20 Circuits.
 Mates with DL20005-Y Series Housing.
 Material : LCP UL94V-0.
 Pin Material : Brass.Tin-plated .

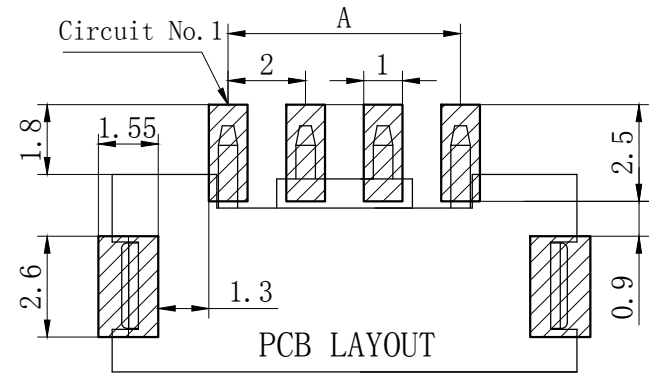
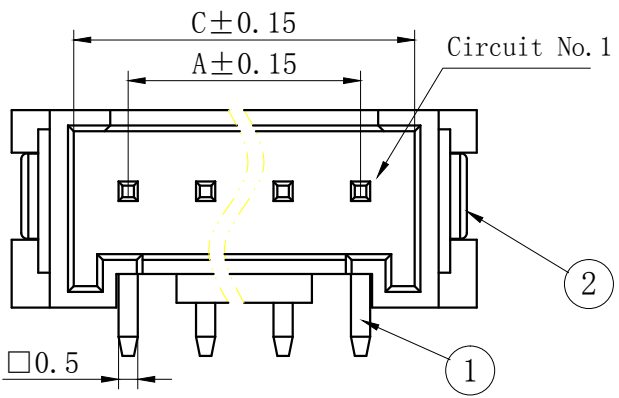

Circuits	Product name	Dimension mm			Circuits	Product name	Dimension mm		
		A	B	C			A	B	C
2	HY-2AB	2.00	8.00	4.75	10	HY-10AB	18.00	24.00	20.75
3	HY-3AB	4.00	10.00	6.75	11	HY-11AB	20.00	26.00	22.75
4	HY-4AB	6.00	12.00	8.75	12	HY-12AB	22.00	28.00	24.75
5	HY-5AB	8.00	14.00	10.75	13	HY-13AB	24.00	30.00	26.75
6	HY-6AB	10.00	16.00	12.75	14	HY-14AB	26.00	32.00	28.75
7	HY-7AB	12.00	18.00	14.75	15	HY-15AB	28.00	34.00	30.75
8	HY-8AB	14.00	20.00	16.75	~	~	~	~	~
9	HY-9AB	16.00	22.00	18.75	20	HY-20AB	38.00	44.00	40.75

3	③	基座	LCP	1	UL94V-0
2	②	焊片	黄铜	2	镀锡
1	①	接触件	黄铜	N	镀锡
序号	图号	名称	材料	数量	附件

GENERAL TOLERANCES (UNLESS SPECIFIED)		ZHE JIANG DELI CONNECTORS CO.,LTD			
.X: ± 0.25	X°: ± 3.0°	PRODUCT NAME: DL20005 (HY)-AB		TITLE: 2.0 mm Pitch Wire To Board SMT Wafer	
.XX: ± 0.15	.X°: ± 2.0°	DR:Chen Quan Long	DATE:21/09/23	PART NO:	
.XXX: ± 0.01	.XX°: ± 1.0°	CHKD:Wu Hui	DATE:21/09/23	SCALE: N/A	PAGE: 1/1
FINISH:		APPD:Ren An De	DATE:21/09/23	UNITS: mm	REV.: A
DRAWING NO:					

REV.	REVISION DESCRIPTION	DATE

NOTES

Available in 02 through 20 Circuits.
 Mates with DL20005-Y Series Housing.
 Material : LCP UL94V-0.
 Pin Material : Brass.Tin-plated .

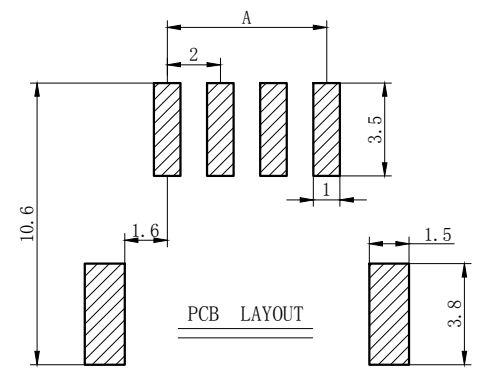
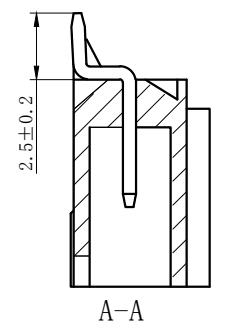
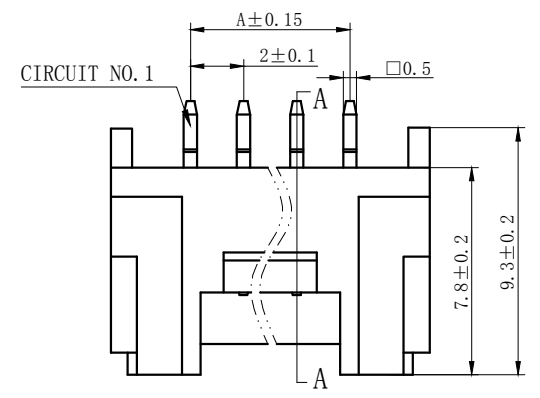
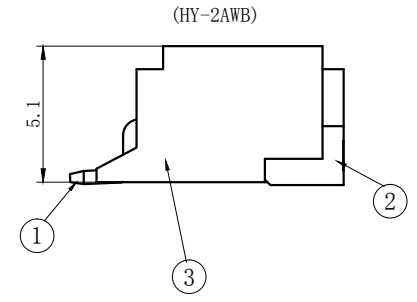
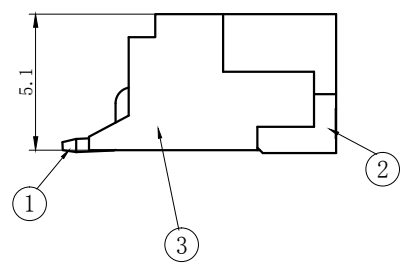
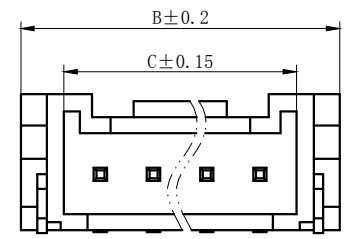

Circuits	Product name	Dimension mm			Circuits	Product name	Dimension mm		
		A	B	C			A	B	C
2	HY-2AWB	2.00	8.00	4.75	10	HY-10AWB	18.00	24.00	20.75
3	HY-3AWB	4.00	10.00	6.75	11	HY-11AWB	20.00	26.00	22.75
4	HY-4AWB	6.00	12.00	8.75	12	HY-12AWB	22.00	28.00	24.75
5	HY-5AWB	8.00	14.00	10.75	13	HY-13AWB	24.00	30.00	26.75
6	HY-6AWB	10.00	16.00	12.75	14	HY-14AWB	26.00	32.00	28.75
7	HY-7AWB	12.00	18.00	14.75	15	HY-15AWB	28.00	34.00	30.75
8	HY-8AWB	14.00	20.00	16.75	~	~	~	~	~
9	HY-9AWB	16.00	22.00	18.75	20	HY-20AWB	38.00	44.00	40.75

序号	图号	名称	材料	数量	附件
3	③	基座	LCP	1	UL94V-0
2	②	焊片	黄铜	2	镀锡
1	①	接触件	黄铜	N	镀锡

GENERAL TOLERANCES (UNLESS SPECIFIED)		ZHE JIANG DELI CONNECTORS CO., LTD	
.X: ± 0.25	X°: ± 3.0°	PRODUCT NAME:	TITLE: 2.0 mm Pitch Wire To Board SMT Wafer
.XX: ± 0.15	.X°: ± 2.0°	DL20005(HY)-AWB	PART NO:
.XXX: ± 0.01	.XX°: ± 1.0°	DR:Chen Quan Long	DATE:21/04/03
FINISH:		CHKD:Wu Hui	DATE:21/04/03
DRAWING NO:		APPD:Ren An De	DATE:21/04/03
		UNITS: mm	PAGE: 1/1
		REV.: A	

REV.	REVISION DESCRIPTION	DATE	APPD

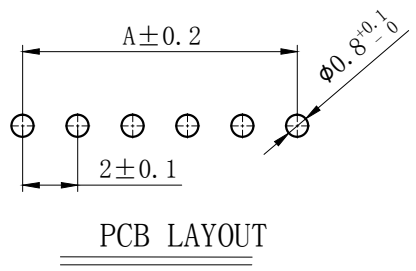
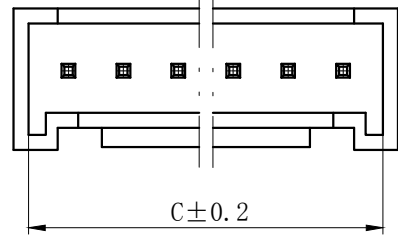
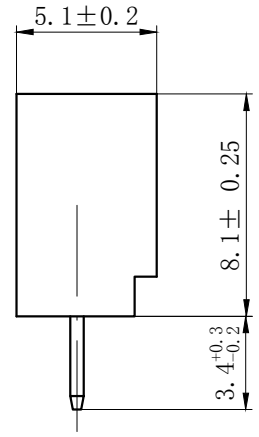
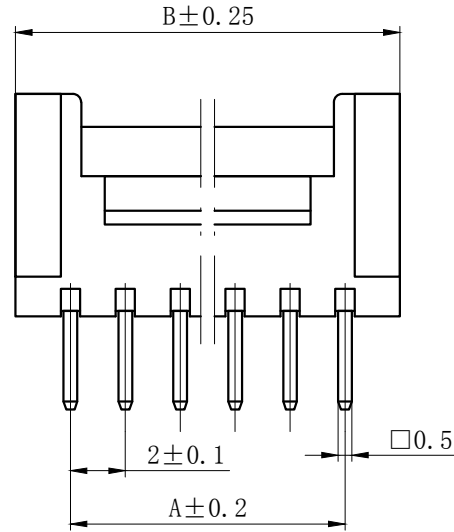
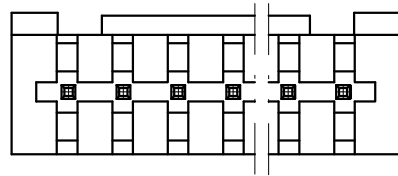

NOTES

Available in 02 through 20 Circuits.
 Mates with DL20005-Y Series Housing.
 Material : Nylon UL94V-0(2).
 0.50mm Square Pin.
 Pin Material : Brass / Tin-Plated.

Circuits	Product name	Dimension mm			Circuits	Product name	Dimension mm		
		A	B	C			A	B	C
2	HY-2A	2.00	6.00	4.90	10	HY-10A	18.00	22.00	20.90
3	HY-3A	4.00	8.00	6.90	11	HY-11A	20.00	24.00	22.90
4	HY-4A	6.00	10.00	8.90	12	HY-12A	22.00	26.00	24.90
5	HY-5A	8.00	12.00	10.90	13	HY-13A	24.00	28.00	26.90
6	HY-6A	10.00	14.00	12.90	14	HY-14A	26.00	30.00	28.90
7	HY-7A	12.00	16.00	14.90	15	HY-15A	28.00	32.00	30.90
8	HY-8A	14.00	18.00	16.90	-	-	-	-	-
9	HY-9A	16.00	20.00	18.90	20	HY-20A	38.00	42.00	40.90

GENERAL TOLERANCES (UNLESS SPECIFIED)		ZHE JIANG DELI CONNECTORS CO., LTD			
.X: ± 0.25	X°: ± 3.0°	PRODUCT NAME: DL20005 (HY)-A		TITLE: 2.00 mm Pitch Wire To Board Wafer	
.XX: ± 0.15	.X°: ± 2.0°	DR: Chen Quan Long	DATE: 21/08/01	PART NO:	
.XXX: ± 0.01	.XX°: ± 1.0°	CHKD: Wu Hui	DATE: 21/08/01	SCALE: N/A	PAGE: 1/1
DRAWING NO:		APPD: Ren An De	DATE: 21/08/01	UNITS: mm	REV.: A

REV.	7	REVISION DESCRIPTION	8	DATE	APPD

NOTES

Available in 02 through 20 Circuits.
 Mates with DL20005-Y Series Housing.
 Material :Nylon UL94V-0(2).
 0.50mm Square Pin.
 Pin Material : Brass / Tin-Plated.

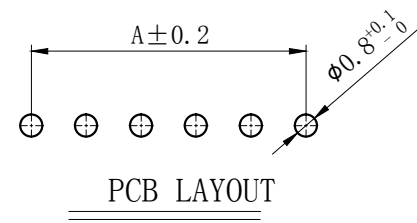
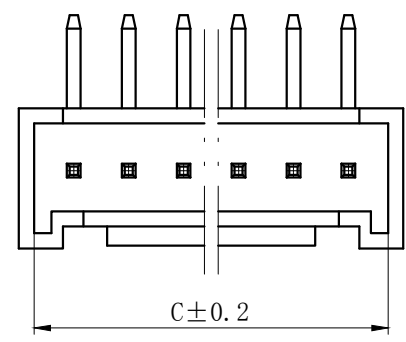
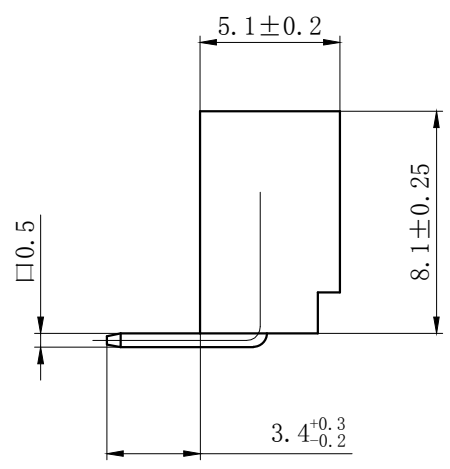
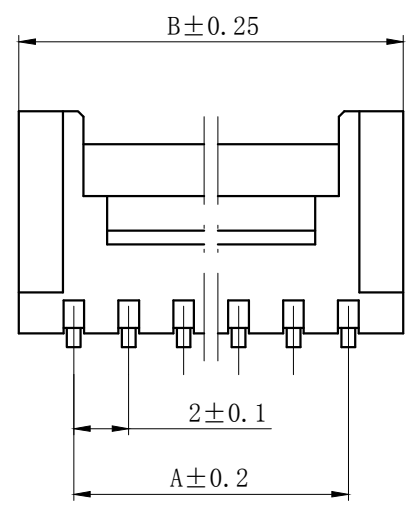
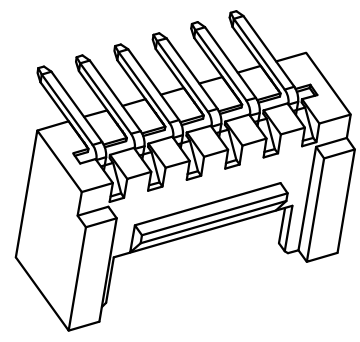
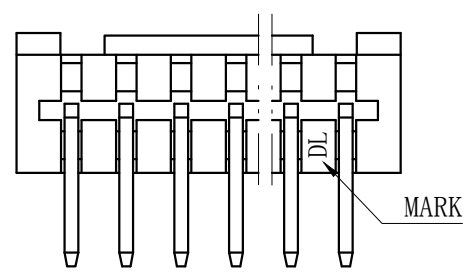

Circuits	Product name	Dimension mm			Circuits	Product name	Dimension mm		
		A	B	C			A	B	C
2	HY-2AW	2.00	6.00	4.90	10	HY-10AW	18.00	22.00	20.90
3	HY-3AW	4.00	8.00	6.90	11	HY-11AW	20.00	24.00	22.90
4	HY-4AW	6.00	10.00	8.90	12	HY-12AW	22.00	26.00	24.90
5	HY-5AW	8.00	12.00	10.90	13	HY-13AW	24.00	28.00	26.90
6	HY-6AW	10.00	14.00	12.90	14	HY-14AW	26.00	30.00	28.90
7	HY-7AW	12.00	16.00	14.90	15	HY-15AW	28.00	32.00	30.90
8	HY-8AW	14.00	18.00	16.90	-	-	-	-	-
9	HY-9AW	16.00	20.00	18.90	20	HY-20AW	38.00	42.00	40.90

GENERAL TOLERANCES (UNLESS SPECIFIED)		ZHE JIANG DELI CONNECTORS CO., LTD			
.X: ± 0.25	.X°: ± 3.0°	PRODUCT NAME: DL20005 (HY)-AW		TITLE: 2.00 mm Pitch Wire To Board Wafer	
.XX: ± 0.15	.XX°: ± 2.0°	DR:Chen Quan Long	DATE:21/08/01	PART NO:	
.XXX: ± 0.01	.XXX°: ± 1.0°	CHKD:Wu Hui	DATE:21/08/01	SCALE: N/A	PAGE: 1/1
DRAWING NO:		APPD:Ren An De	DATE:21/08/01	UNITS: mm	REV.: A

REV.	7	REVISION DESCRIPTION	8	DATE	APPD

NOTES

Available in 02 through 20 Circuits.
 Mates with DL20005-Y Series Housing.
 Material :Nylon UL94V-0(2).
 0.50mm Square Pin.
 Pin Material : Brass / Tin-Plated.

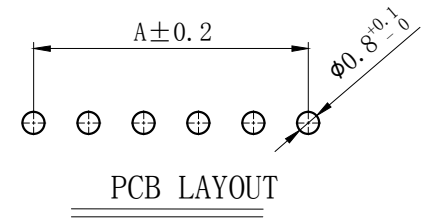
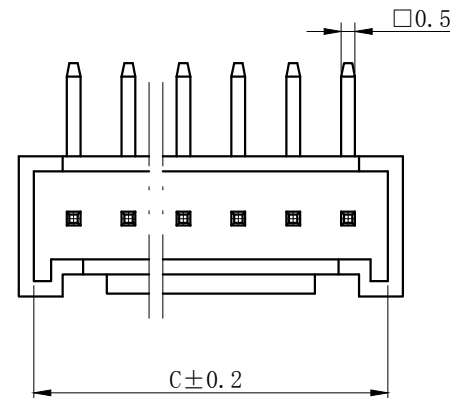
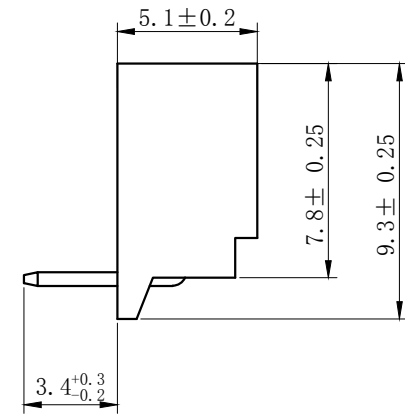
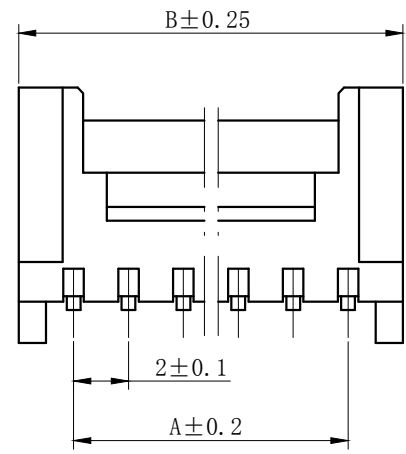
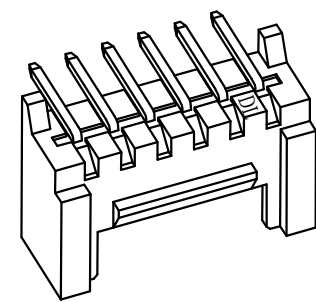
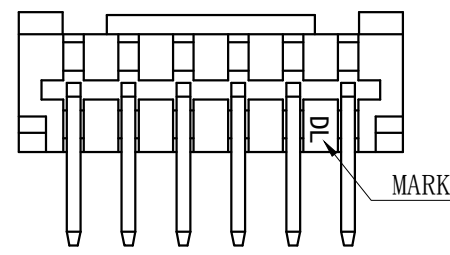

Circuits	Product name	Dimension mm			Circuits	Product name	Dimension mm		
		A	B	C			A	B	C
2	HY-2AWD	2.00	6.00	4.90	10	HY-10AWD	18.00	22.00	20.90
3	HY-3AWD	4.00	8.00	6.90	11	HY-11AWD	20.00	24.00	22.90
4	HY-4AWD	6.00	10.00	8.90	12	HY-12AWD	22.00	26.00	24.90
5	HY-5AWD	8.00	12.00	10.90	13	HY-13AWD	24.00	28.00	26.90
6	HY-6AWD	10.00	14.00	12.90	14	HY-14AWD	26.00	30.00	28.90
7	HY-7AWD	12.00	16.00	14.90	15	HY-15AWD	28.00	32.00	30.90
8	HY-8AWD	14.00	18.00	16.90	-	-	-	-	-
9	HY-9AWD	16.00	20.00	18.90	20	HY-20AWD	38.00	42.00	40.90

GENERAL TOLERANCES (UNLESS SPECIFIED)		ZHE JIANG DELI CONNECTORS CO., LTD			
.X: ± 0.25	X°: ± 3.0°	PRODUCT NAME: DL20005 (HY)-AWD		TITLE: 2.00 mm Pitch Wire To Board Wafer	
.XX: ± 0.15	.X°: ± 2.0°	DR:Chen Quan Long	DATE:21/08/01	PART NO:	
.XXX: ± 0.01	.XX°: ± 1.0°	CHKD:Wu Hui	DATE:21/08/01	SCALE: N/A	PAGE: 1/1
DRAWING NO:		APPD:Ren An De	DATE:21/08/01	UNITS: mm	REV.: A

REV.	REVISION DESCRIPTION	DATE	APPD

NOTES

Available in 02 through 20 Circuits.
 Mates with DL20005-Y Series Housing.
 Material :Nylon UL94V-0(2).
 0.50mm Square Pin.
 Pin Material : Brass / Tin-Plated.

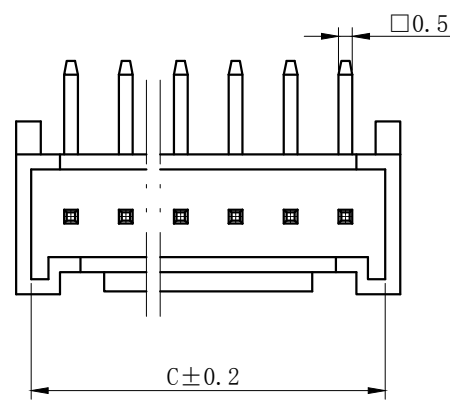
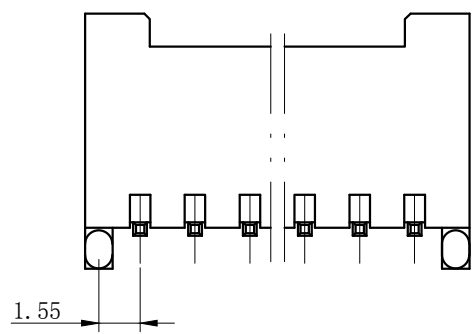
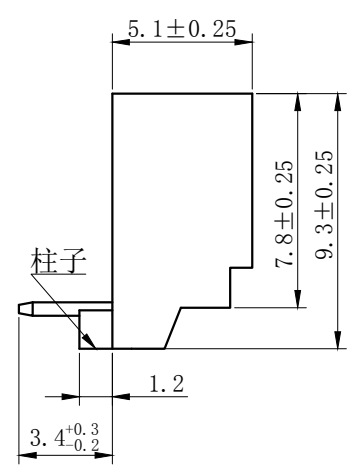
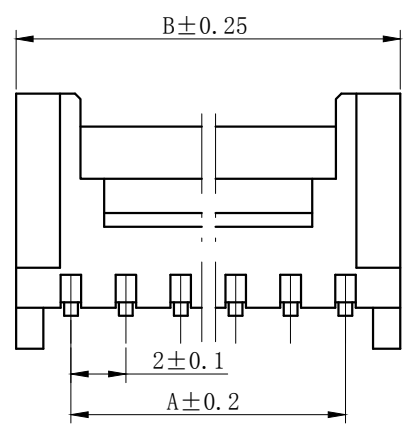
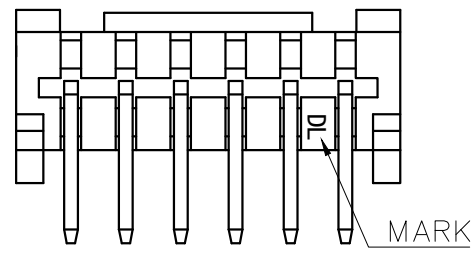

Circuits	Product name	Dimension mm			Circuits	Product name	Dimension mm		
		A	B	C			A	B	C
2	HY-2AWD-S	2.00	6.00	4.90	10	HY-10AWD-S	18.00	22.00	20.90
3	HY-3AWD-S	4.00	8.00	6.90	11	HY-11AWD-S	20.00	24.00	22.90
4	HY-4AWD-S	6.00	10.00	8.90	12	HY-12AWD-S	22.00	26.00	24.90
5	HY-5AWD-S	8.00	12.00	10.90	13	HY-13AWD-S	24.00	28.00	26.90
6	HY-6AWD-S	10.00	14.00	12.90	14	HY-14AWD-S	26.00	30.00	28.90
7	HY-7AWD-S	12.00	16.00	14.90	15	HY-15AWD-S	28.00	32.00	30.90
8	HY-8AWD-S	14.00	18.00	16.90	-	-	-	-	-
9	HY-9AWD-S	16.00	20.00	18.90	20	HY-20AWD-S	38.00	42.00	40.90

GENERAL TOLERANCES (UNLESS SPECIFIED)		ZHE JIANG DELI CONNECTORS CO., LTD	
.X: ± 0.25	X°: ± 3.0°	PRODUCT NAME: DL20005 (HY)-AWD-S	TITLE: 2.00 mm Pitch Wire To Board Wafer
.XX: ± 0.15	.X°: ± 2.0°	DR:Chen Quan Long	DATE:21/08/01
.XXX: ± 0.01	.XX°: ± 1.0°	CHKD:Wu Hui	DATE:21/08/01
FINISH:		APPD:Ren An De	DATE:21/08/01
DRAWING NO:			
		SCALE: N/A	PAGE: 1/1
		UNITS: mm	REV.: A

REV.	REVISION DESCRIPTION	DATE	APPD

NOTES

Available in 02 through 20 Circuits.
 Mates with DL20038-Y Series Housing.
 Material : Nylon UL94V-0 (2) .
 0.50mm Square Pin.
 Pin Material : Brass / Tin-Plated.

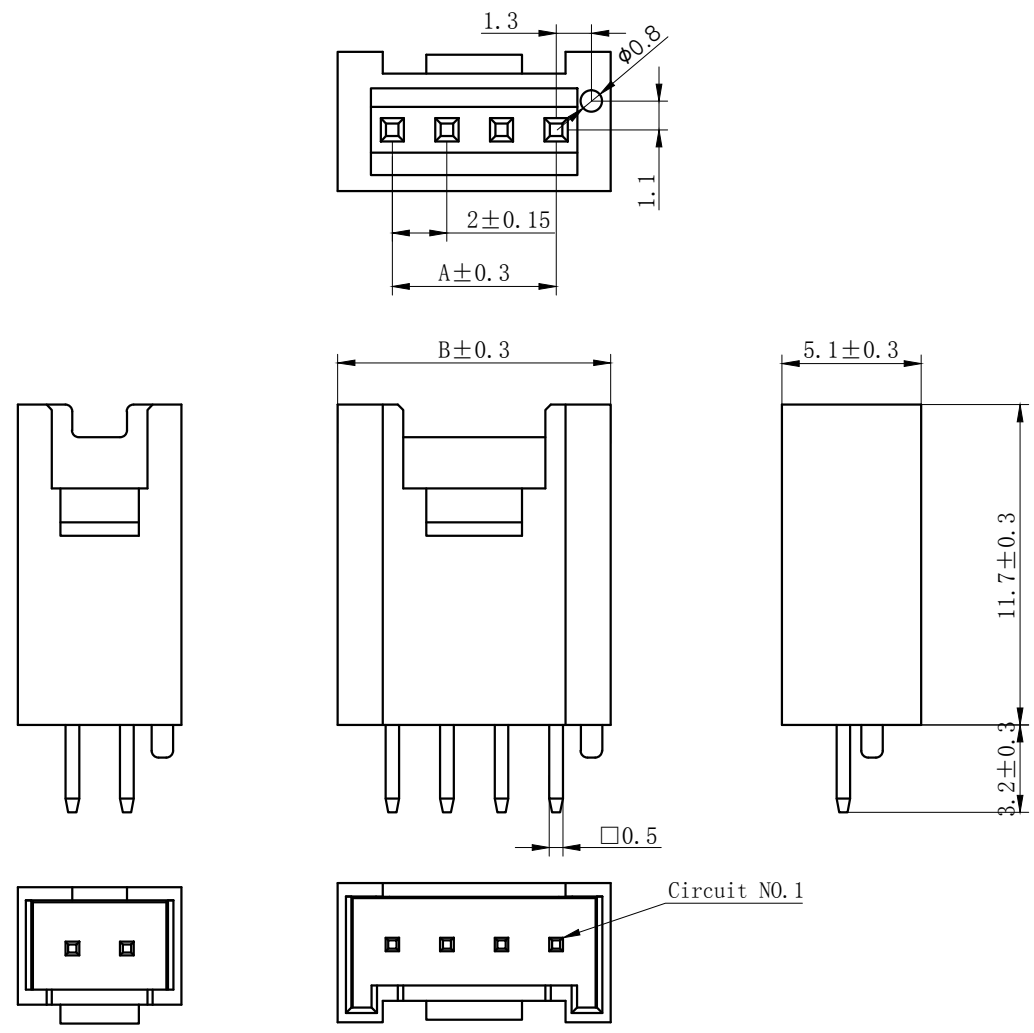

Circuits	Product name	Dimensino (mm)		Circuits	Product name	Dimensino (mm)	
		A	B			A	B
2	HY-H-2AS	2.0	6.0	9	HY-H-9AS	16.0	20.0
3	HY-H-3AS	4.0	8.0	10	HY-H-10AS	18.0	22.0
4	HY-H-4AS	6.0	10.0	11	HY-H-11AS	20.0	24.0
5	HY-H-5AS	8.0	12.0	12	HY-H-12AS	22.0	26.0
6	HY-H-6AS	10.0	14.0	13	HY-H-13AS	24.0	28.0
7	HY-H-7AS	12.0	16.0	~	~	~	~
8	HY-H-8AS	14.0	18.0	20	HY-H-20AS	38.0	42.0

GENERAL TOLERANCES (UNLESS SPECIFIED)		ZHE JIANG DELI CONNECTORS CO., LTD	
.X: ± 0.25	X°: $\pm 3.0^\circ$	PRODUCT NAME:	TITLE: 2.00 mm Pitch Wire To Board Wafer
.XX: ± 0.15	.X°: $\pm 2.0^\circ$	DL20038 (HY-H)-AS	
.XXX: ± 0.01	.XX°: $\pm 1.0^\circ$	DR: Chen Quan Long	DATE: 22/05/01
FINISH:		CHKD: Wu Hui	DATE: 22/05/01
DRAWING NO:		APPD: Ren An De	DATE: 22/05/01
		SCALE: N/A	PAGE: 1/1
		UNITS: mm	REV.: A

REV.	REVISION DESCRIPTION	DATE	APPD

NOTES

Available in 02 through 20 Circuits.
 Match with DL20005 series housing
 Material : Nylon UL94V-0(2).
 Accepts DL20005-T Crimp Terminal.

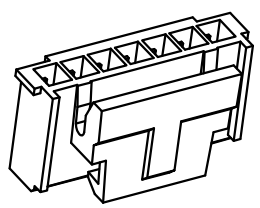
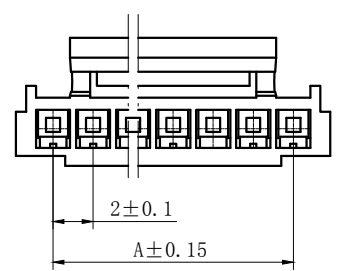
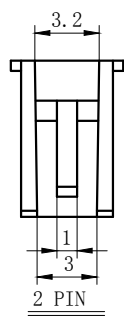
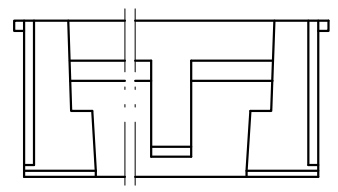
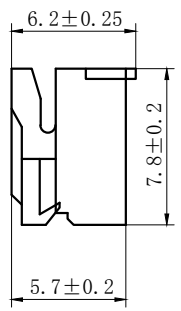
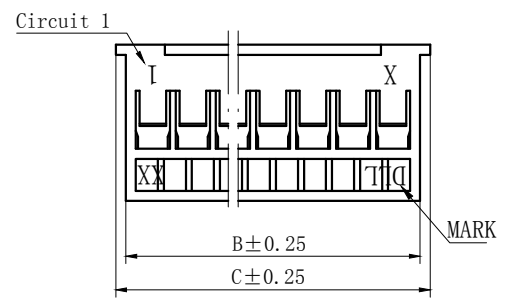
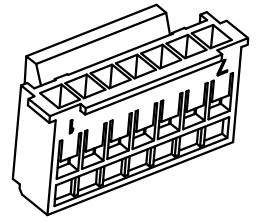
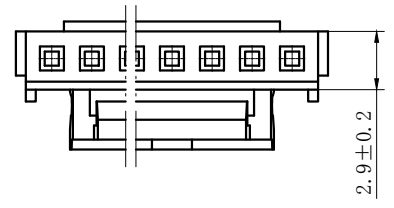

Circuits	Product name	Dimensino (mm)			Circuits	Product name	Dimensino (mm)		
		A	B	C			A	B	C
2	HY-2Y	2.00	4.60	5.60	12	HY-12Y	22.00	24.60	25.60
3	HY-3Y	4.00	6.60	7.60	13	HY-13Y	24.00	26.60	27.60
4	HY-4Y	6.00	8.60	9.60	14	HY-14Y	26.00	28.60	29.60
5	HY-5Y	8.00	10.60	11.60	15	HY-15Y	28.00	30.60	31.60
6	HY-6Y	10.00	12.60	13.60	16	HY-16Y	30.00	32.60	33.60
7	HY-7Y	12.00	14.60	15.60	17	HY-17Y	32.00	34.60	35.60
8	HY-8Y	14.00	16.60	17.60	18	HY-18Y	34.00	36.60	37.60
9	HY-9Y	16.00	18.60	19.60	19	HY-19Y	36.00	38.60	39.60
10	HY-10Y	18.00	20.60	21.60	20	HY-20Y	38.00	40.60	41.60
11	HY-11Y	20.00	22.60	23.60	-	-	-	-	-

GENERAL TOLERANCES (UNLESS SPECIFIED)		ZHE JIANG DELI CONNECTORS CO., LTD	
.X: ± 0.25	.X°: ± 3.0°	PRODUCT NAME:	TITLE:
.XX: ± 0.15	.XX°: ± 2.0°	DL20005 (HY)-Y	2.00 mm Pitch Housing
.XXX: ± 0.01	.XXX°: ± 1.0°	DR:Chen Quan Long	DATE:21/08/01
FINISH:		CHKD: Wu Hui	DATE:21/08/01
DRAWING NO:		APPD:Ren An De	DATE:21/08/01
		SCALE: N/A	PAGE: 1/1
		UNITS: mm	REV.: A

REV.	REVISION DESCRIPTION	DATE	APPD

NOTES

Available in 02 Circuits.
 Match with DL20005 series housing
 Material : Nylon UL94V-0(2).
 Accepts DL20005-T Crimp Terminal.

CIRCUIT NO. 1

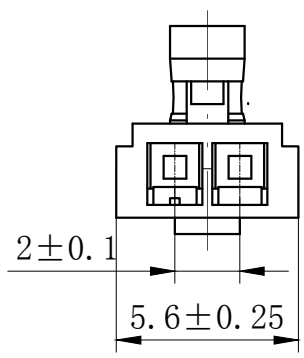
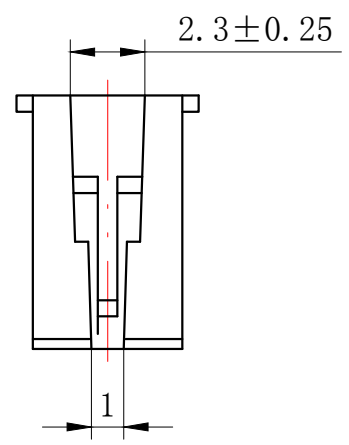
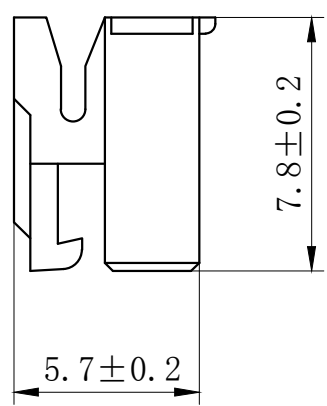
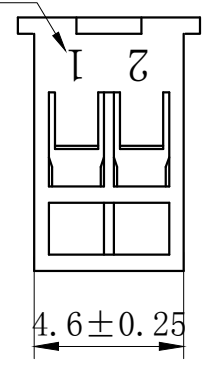

GENERAL TOLERANCES (UNLESS SPECIFIED)		ZHE JIANG DELI CONNECTORS CO., LTD	
.X: ± 0.25	X°: ± 3.0°	PRODUCT NAME: DL20005 (HY)-2Y-WJ	TITLE: 2.00 mm Pitch Housing
.XX: ± 0.15	.X°: ± 2.0°	DR: Chen Quan Long	DATE: 21/08/01
.XXX: ± 0.01	.XX°: ± 1.0°	CHKD: Wu Hui	DATE: 21/08/01
FINISH:		APPD: Ren An De	DATE: 21/08/01
DRAWING NO:		SCALE: N/A	PAGE: 1/1
		UNITS: mm	REV.: A

REV.	REVISION DESCRIPTION	DATE	APPD

CIRCUIT NO. 1

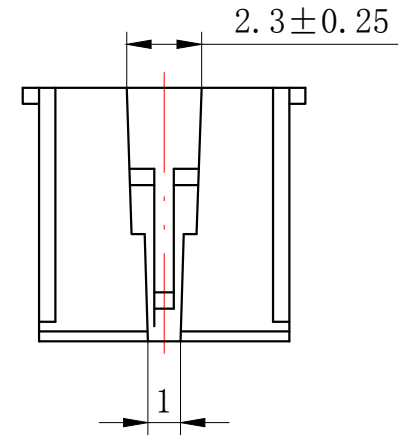
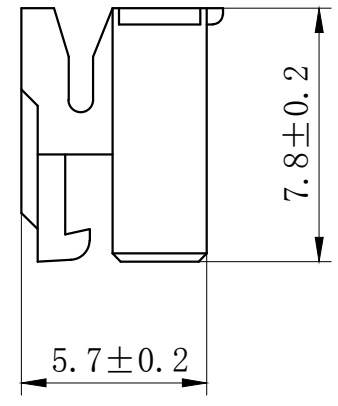
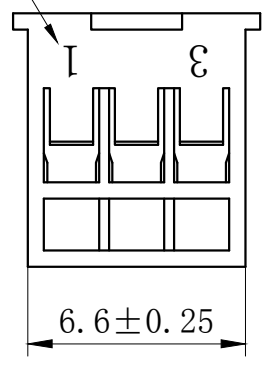

NOTES

Available in 03 Circuits.
 Match with DL20005 series housing
 Material : Nylon UL94V-0(2).
 Accepts DL20005-T Crimp Terminal.

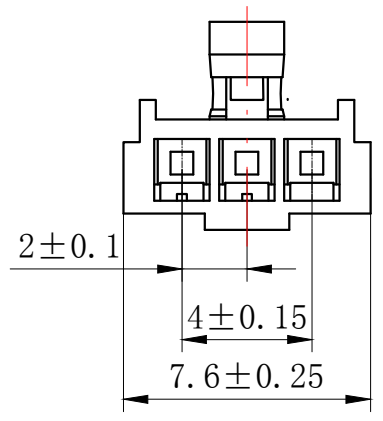

GENERAL TOLERANCES (UNLESS SPECIFIED)		ZHE JIANG DELI CONNECTORS CO., LTD	
.X: ± 0.25	X°: ± 3.0°	PRODUCT NAME:	TITLE:
.XX: ± 0.15	.X°: ± 2.0°	DL20005 (HY)-3Y-WJ	2.00 mm Pitch Housing
.XXX: ± 0.01	.XX°: ± 1.0°	DR:Chen Quan Long	DATE:21/08/01
FINISH:		CHKD: Wu Hui	DATE:21/08/01
DRAWING NO:		APPD:Ren An De	DATE:21/08/01
		SCALE: N/A	PAGE: 1/1
		UNITS: mm	REV.: A

REV.	REVISION DESCRIPTION	DATE	APPD

NOTES

Available in 04 through 20 Circuits.
 Match with DL20005 series housing
 Material : Nylon UL94V-0(2).
 Accepts DL20005-T Crimp Terminal.

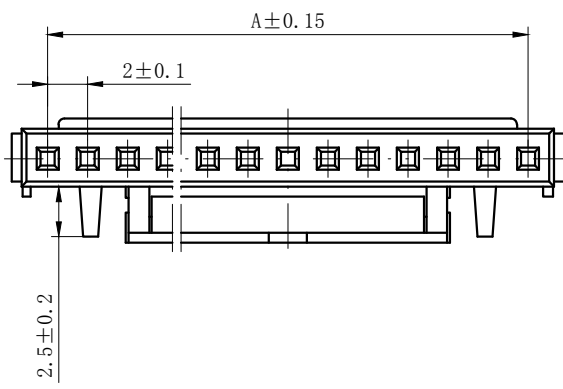
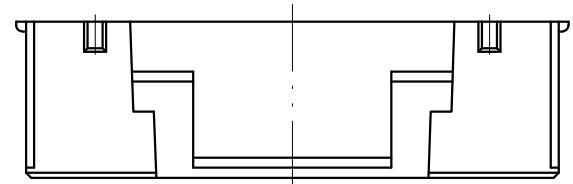
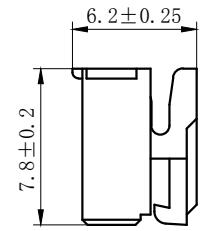
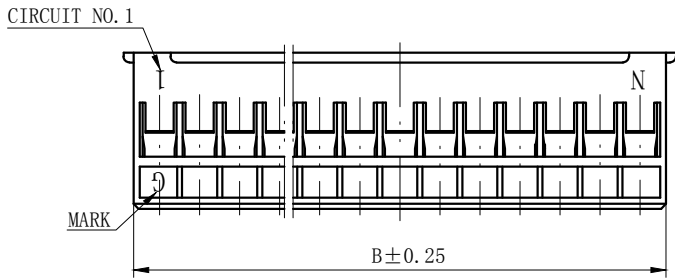
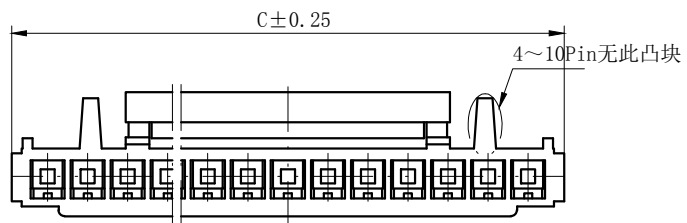

Circuits	Product name	Dimension mm			Circuits	Product name	Dimension mm		
		A	B	C			A	B	C
4	HY-4Y-WJ	6.00	8.60	9.60	11	HY-11Y-WJ	20.00	22.60	23.60
5	HY-5Y-WJ	8.00	10.60	11.60	12	HY-12Y-WJ	22.00	24.60	25.60
6	HY-6Y-WJ	10.00	12.60	13.60	13	HY-13Y-WJ	24.00	26.60	27.60
7	HY-7Y-WJ	12.00	14.60	15.60	14	HY-14Y-WJ	26.00	28.60	29.60
8	HY-8Y-WJ	14.00	16.60	17.60	15	HY-15Y-WJ	28.00	30.60	31.60
9	HY-9Y-WJ	16.00	18.60	19.60	~	~	~	~	~
10	HY-10Y-WJ	18.00	20.60	21.60	20	HY-20Y-WJ	38.00	40.60	41.60

GENERAL TOLERANCES (UNLESS SPECIFIED)		ZHE JIANG DELI CONNECTORS CO., LTD	
.X: ± 0.25	.X°: ± 3.0°	PRODUCT NAME:	TITLE:
.XX: ± 0.15	.XX°: ± 2.0°	DL20005 (HY)-Y-WJ	2.00 mm Pitch Housing
.XXX: ± 0.01	.XXX°: ± 1.0°	DR:Chen Quan Long	DATE:21/08/01
FINISH:		CHKD: Wu Hui	DATE:21/08/01
DRAWING NO:		APPD:Ren An De	DATE:21/08/01
			PART NO:
			SCALE: N/A
			PAGE: 1/1
			UNITS: mm
			REV.: A

REV.	REVISION DESCRIPTION	DATE	APPD

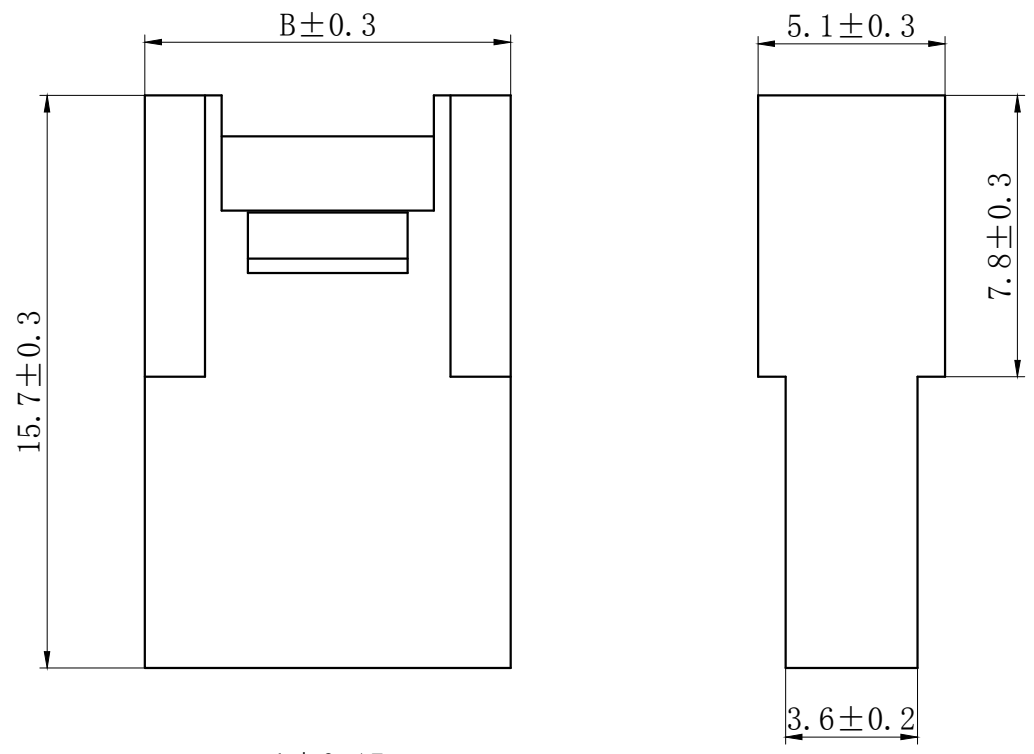

NOTES

Available in 02 through 20 Circuits.
 Mates with DL20005-Y Series Housing.
 Material : Nylon UL94V-0(2).
 Accepts DL20005-RT Crimp Terminal.

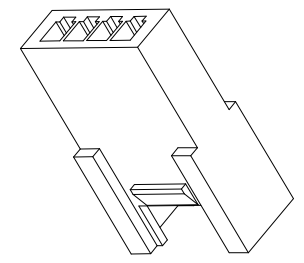
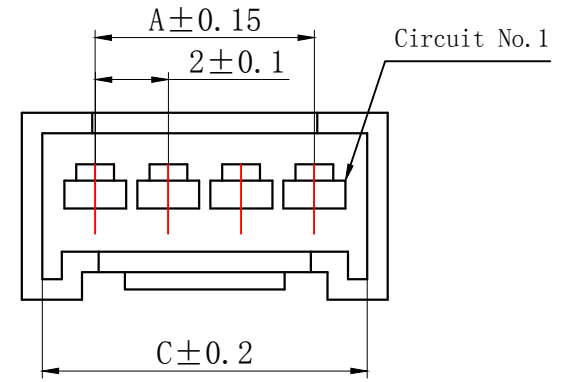

Circuits	Product name	Dimension mm			Circuits	Product name	Dimension mm		
		A	B	C			A	B	C
2	HY-2R	2.00	6.00	4.9	10	HY-10R	18.00	22.00	20.9
3	HY-3R	4.00	8.00	6.9	11	HY-11R	20.00	24.00	22.9
4	HY-4R	6.00	10.00	8.9	12	HY-12R	22.00	26.00	24.9
5	HY-5R	8.00	12.00	10.9	13	HY-13R	24.00	28.00	26.9
6	HY-6R	10.00	14.00	12.9	14	HY-14R	26.00	30.00	28.9
7	HY-7R	12.00	16.00	14.9	15	HY-15R	28.00	32.00	30.9
8	HY-8R	14.00	18.00	16.9	~	~	~	~	~
9	HY-9R	16.00	20.00	18.9	20	HY-20R	38.00	42.00	40.9

GENERAL TOLERANCES (UNLESS SPECIFIED)		ZHE JIANG DELI CONNECTORS CO., LTD	
.X: ± 0.25	X°: ± 3.0°	DL20005 (HY) -R	
.XX: ± 0.15	.X°: ± 2.0°		
.XXX: ± 0.01	.XX°: ± 1.0°	DR: Chen Quan Long	DATE:20/10/12
FINISH:		CHKD: Wu Hui	DATE:20/10/12
DRAWING NO:		APPD: Ren An De	DATE:20/10/12
		TITLE: 2.00 mm Pitch Wire To Wire Housing	
		PART NO:	
		SCALE: N/A	PAGE: 1/1
		UNITS: mm	REV.: A

REV.	REVISION DESCRIPTION	DATE	APPD

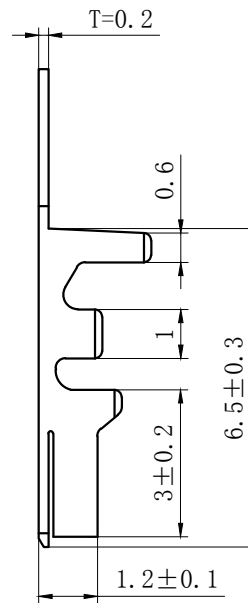
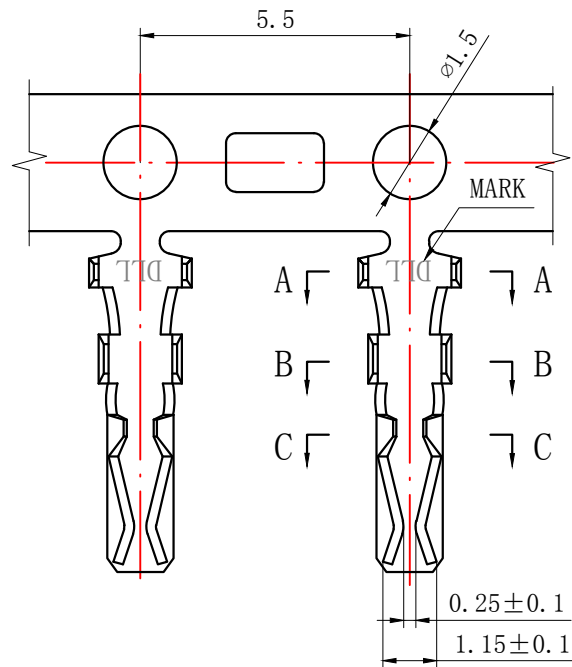

NOTES

Used in DL20005-Y Series Housing.
 Accepts AWG #28~22 Wire Range.
 0.05~ 0.33 mm² .
 Insulation O.D.=0.9~1.8 mm.
 Material : Phosphor Bronze .
 Finish: Tin plated.
 Thickness: 0.2 mm.

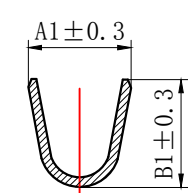

SECTION A-A

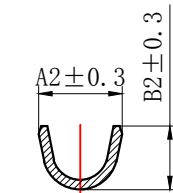

SECTION B-B

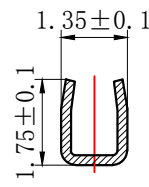

SECTION C-C

TYPE	Dimension mm				适用线规AWG
	A1	B1	A2	B2	
HY-T-G	2.1	2.2	1.7	1.7	#24-22
HY-T	2.1	2.2	1.7	1.3	#26-24
HY-T-D	1.7	1.7	1.3	1.2	#28-26

GENERAL TOLERANCES (UNLESS SPECIFIED)		ZHE JIANG DELI CONNECTORS CO., LTD	
.X: ± 0.25	X°: ± 3.0°	PRODUCT NAME: DL20005(HY)-T	
.XX: ± 0.15	.X°: ± 2.0°	TITLE: 2.00 mm Pitch Crimp Terminal	
.XXX: ± 0.01	.XX°: ± 1.0°	DR: Chen Quan Long	DATE: 21/03/13
FINISH:		CHKD: Wu Hui	DATE: 21/03/13
DRAWING NO:		APPD: Ren An De	DATE: 21/03/13
			PART NO:
			SCALE: N/A
			PAGE: 1/1
			UNITS: mm
			REV.: A

REV.	REVISION DESCRIPTION	DATE	APPD

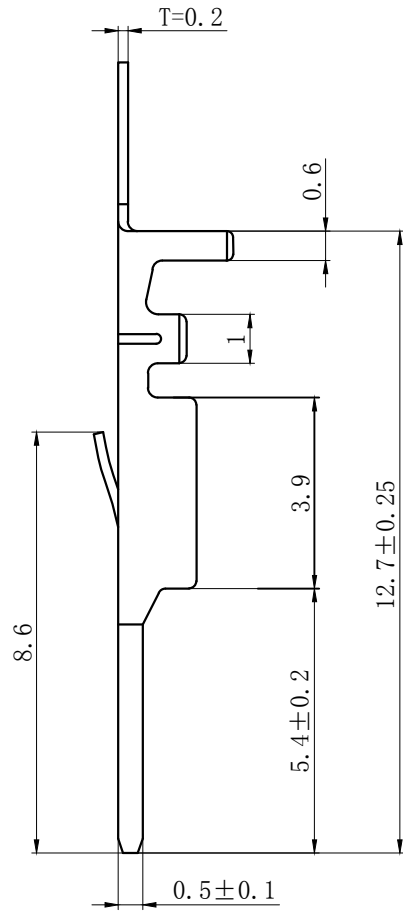
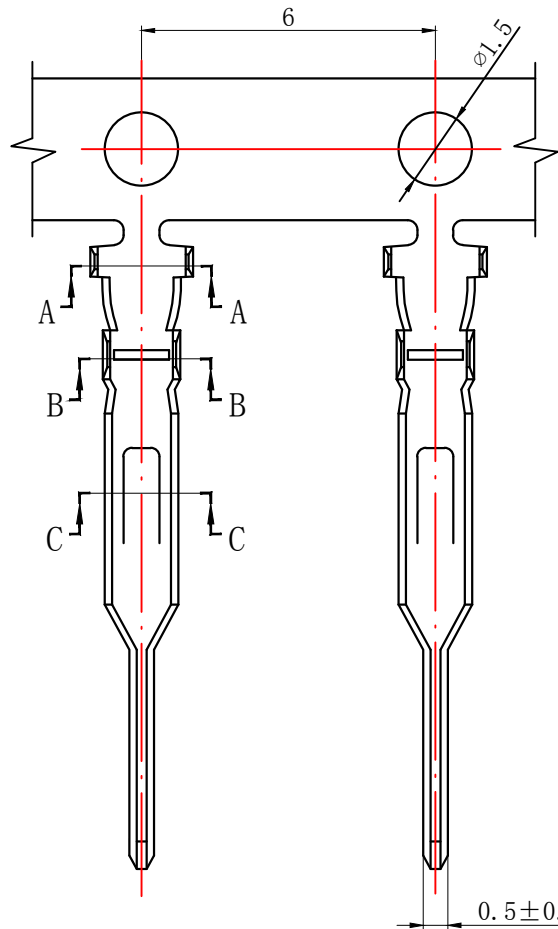

NOTES

Used in DL20005-R Series Housing.
Accepts AWG #28~22 Wire Range.

0.08~ 0.33 mm² .

Insulation O.D. =0.9~1.8mm.

Material : Phosphor Bronze .

Finish: Tin plated.

Thickness: 0.2 mm.

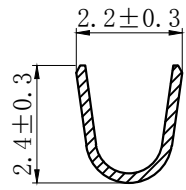

SECTION A-A

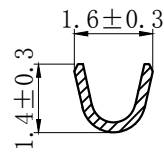

SECTION B-B

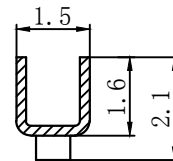

SECTION C-C

GENERAL TOLERANCES (UNLESS SPECIFIED)		ZHE JIANG DELI CONNECTORS CO ., LTD	
.X: ± 0.25	X° : ± 3.0°	PRODUCT NAME:	TITLE:
.XX: ± 0.15	.X° : ± 2.0°	DL20005 (HY) -RT	2.00 mm Pitch Wire To Wire Crimp Terminal
.XXX: ± 0.01	.XX° : ± 1.0°	DR:Chen Quan Long	DATE:20/12/30
FINISH:		CHKD: Wu Hui	DATE:20/12/30
DRAWING NO:		APPD:Ren An De	DATE:20/12/30
		SCALE: N/A	PAGE: 1/1
		UNITS: mm	REV.: A

X-ON Electronics

Largest Supplier of Electrical and Electronic Components

Click to view similar products for [Headers & Wire Housings](#) category:

Click to view products by [DLL](#) manufacturer:

Other Similar products are found below :

[0015917161](#) [0022155065](#) [57102-F02-18ULF](#) [58102-G61-06LF](#) [582553-1](#) [01.001.5753.1](#) [0050291907](#) [02.125.8002.8](#) [609-3404](#) [61062-3](#)
[CSU011177004](#) [622-0430](#) [622-3653LF](#) [63453-116](#) [636-1030](#) [636-1427](#) [636-3427](#) [636-4007](#) [641938-9](#) [65495-038](#) [65692-001LF](#) [65781-018](#)
[65781-047](#) [65817-010LF](#) [65817-015LF](#) [67095-007LF](#) [67601157](#) [68631-112](#) [68645-018](#) [699319-000](#) [70.362.1628.0](#) [70-4210](#) [70-4226B](#) [70-](#)
[4853B](#) [71.350.2428.0](#) [733-134](#) [733-162](#) [760-3052](#) [MHR-64-VUAL](#) [80.063.4001.1](#) [800-90-001-10-001000](#) [801-43-002-10-013000](#)
[801-43-006-10-002000](#) [803-43-024-10-001000](#) [803-93-012-10-001000](#) [8-1437020-4](#) [819-22-004-30-001101](#) [820-22-006-30-001101](#)
[820-22-008-30-001101](#) [821-22-002-10-001101](#)