

技术特性/Specifications:

额定电压 Rated voltage: 50V AC, DC
额定电流 Rated current: 1A AC, DC
接触电阻 Contact resistance: 20mΩ max
绝缘电阻 Insulation resistance: 100MΩ min
耐压 Withstand voltage: 500V AC/minute
环境温度 Ambient temperature: -40°C~+105°C
适用线规 Wire range: AWG#32~#28

| | | |
|------|----------------------|------|
| REV. | REVISION DESCRIPTION | DATE |
| | | |

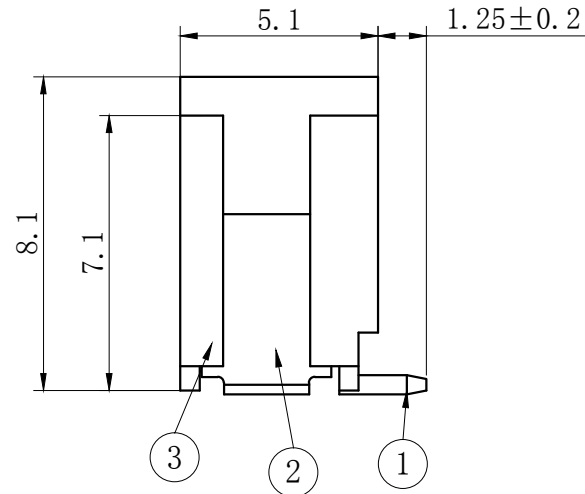
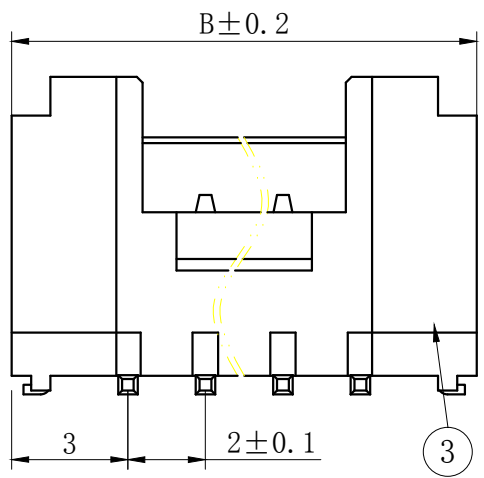

NOTES

Available in 02 through 20 Circuits.
 Mates with DL20005-Y Series Housing.
 Material : LCP UL94V-0.
 Pin Material : Brass.Tin-plated .

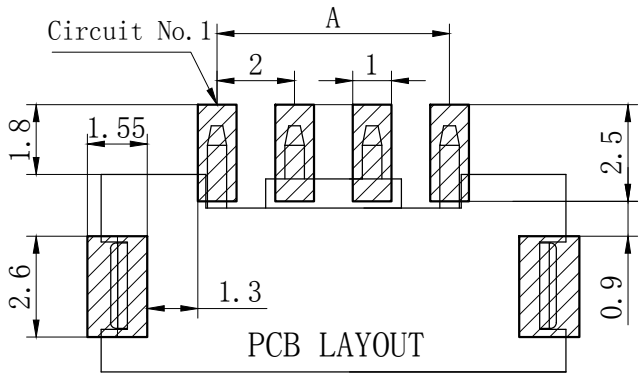
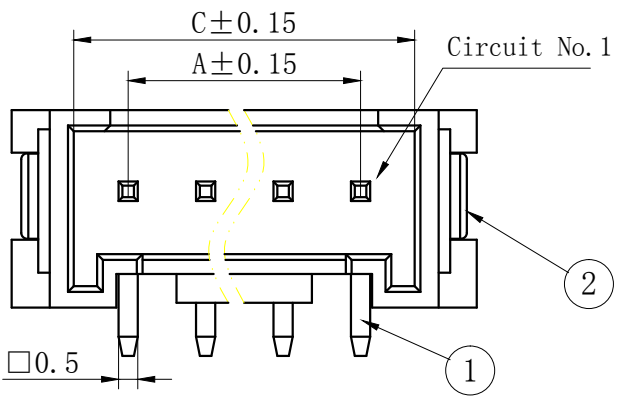

| | | | | | |
|----|----|-----|-----|----|---------|
| 3 | ③ | 基座 | LCP | 1 | UL94V-0 |
| 2 | ② | 焊片 | 黄铜 | 2 | 镀锡 |
| 1 | ① | 接触件 | 黄铜 | N | 镀锡 |
| 序号 | 图号 | 名称 | 材料 | 数量 | 附件 |

| Circuits | Product name | Dimension mm | | | Circuits | Product name | Dimension mm | | |
|----------|--------------|--------------|-------|-------|----------|--------------|--------------|-------|-------|
| | | A | B | C | | | A | B | C |
| 2 | HY-2AB | 2.00 | 8.00 | 4.75 | 10 | HY-10AB | 18.00 | 24.00 | 20.75 |
| 3 | HY-3AB | 4.00 | 10.00 | 6.75 | 11 | HY-11AB | 20.00 | 26.00 | 22.75 |
| 4 | HY-4AB | 6.00 | 12.00 | 8.75 | 12 | HY-12AB | 22.00 | 28.00 | 24.75 |
| 5 | HY-5AB | 8.00 | 14.00 | 10.75 | 13 | HY-13AB | 24.00 | 30.00 | 26.75 |
| 6 | HY-6AB | 10.00 | 16.00 | 12.75 | 14 | HY-14AB | 26.00 | 32.00 | 28.75 |
| 7 | HY-7AB | 12.00 | 18.00 | 14.75 | 15 | HY-15AB | 28.00 | 34.00 | 30.75 |
| 8 | HY-8AB | 14.00 | 20.00 | 16.75 | ~ | ~ | ~ | ~ | ~ |
| 9 | HY-9AB | 16.00 | 22.00 | 18.75 | 20 | HY-20AB | 38.00 | 44.00 | 40.75 |

| | | | |
|---------------------------------------|--------------|---|---|
| GENERAL TOLERANCES (UNLESS SPECIFIED) | | ZHE JIANG DELI CONNECTORS CO.,LTD | |
| .X: ± 0.25 | X°: ± 3.0° | PRODUCT NAME: DL20005 (HY)-AB | TITLE: 2.0 mm Pitch Wire To Board SMT Wafer |
| .XX: ± 0.15 | .X°: ± 2.0° | DR:Chen Quan Long | DATE:21/09/23 |
| .XXX: ± 0.01 | .XX°: ± 1.0° | DATE:21/09/23 | PART NO: |
| FINISH: | | CHKD:Wu Hui | DATE:21/09/23 |
| DRAWING NO: | | APPD:Ren An De | DATE:21/09/23 |
| | | UNITS: mm | PAGE: 1/1 |
| | | REV.: A | |

| | | |
|------|----------------------|------|
| REV. | REVISION DESCRIPTION | DATE |
| | | |

NOTES

Available in 02 through 20 Circuits.
 Mates with DL20005-Y Series Housing.
 Material : LCP UL94V-0.
 Pin Material : Brass.Tin-plated .

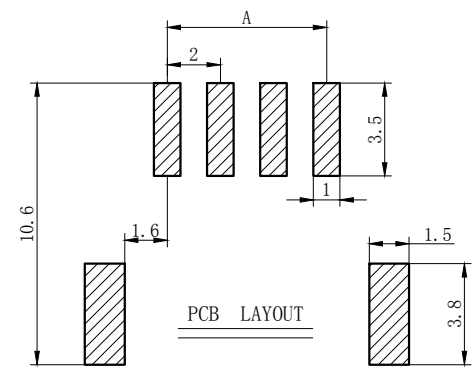
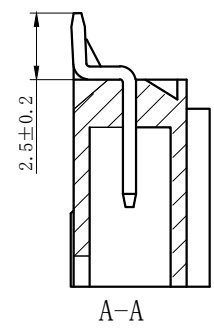
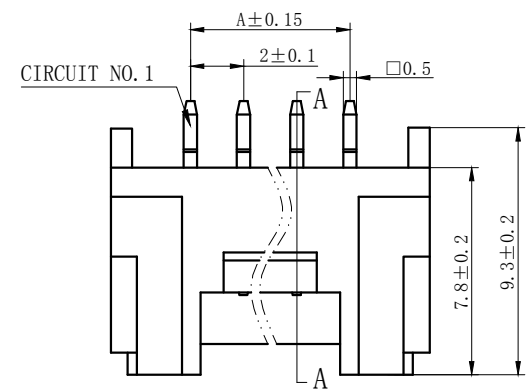
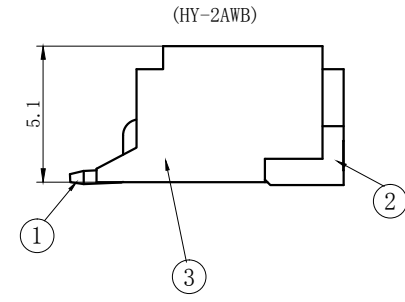
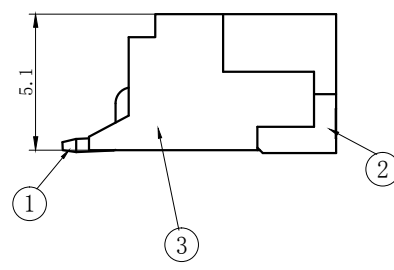
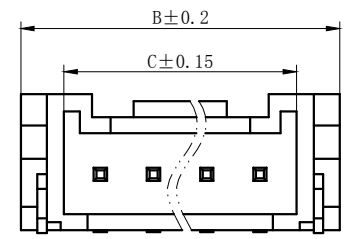

| Circuits | Product name | Dimension mm | | | Circuits | Product name | Dimension mm | | |
|----------|--------------|--------------|-------|-------|----------|--------------|--------------|-------|-------|
| | | A | B | C | | | A | B | C |
| 2 | HY-2AWB | 2.00 | 8.00 | 4.75 | 10 | HY-10AWB | 18.00 | 24.00 | 20.75 |
| 3 | HY-3AWB | 4.00 | 10.00 | 6.75 | 11 | HY-11AWB | 20.00 | 26.00 | 22.75 |
| 4 | HY-4AWB | 6.00 | 12.00 | 8.75 | 12 | HY-12AWB | 22.00 | 28.00 | 24.75 |
| 5 | HY-5AWB | 8.00 | 14.00 | 10.75 | 13 | HY-13AWB | 24.00 | 30.00 | 26.75 |
| 6 | HY-6AWB | 10.00 | 16.00 | 12.75 | 14 | HY-14AWB | 26.00 | 32.00 | 28.75 |
| 7 | HY-7AWB | 12.00 | 18.00 | 14.75 | 15 | HY-15AWB | 28.00 | 34.00 | 30.75 |
| 8 | HY-8AWB | 14.00 | 20.00 | 16.75 | ~ | ~ | ~ | ~ | ~ |
| 9 | HY-9AWB | 16.00 | 22.00 | 18.75 | 20 | HY-20AWB | 38.00 | 44.00 | 40.75 |

| 序号 | 图号 | 名称 | 材料 | 数量 | 附件 |
|----|----|-----|-----|----|---------|
| 3 | ③ | 基座 | LCP | 1 | UL94V-0 |
| 2 | ② | 焊片 | 黄铜 | 2 | 镀锡 |
| 1 | ① | 接触件 | 黄铜 | N | 镀锡 |

| | | | |
|---------------------------------------|--------------|------------------------------------|---|
| GENERAL TOLERANCES (UNLESS SPECIFIED) | | ZHE JIANG DELI CONNECTORS CO., LTD | |
| .X: ± 0.25 | X°: ± 3.0° | PRODUCT NAME: | TITLE: 2.0 mm Pitch Wire To Board SMT Wafer |
| .XX: ± 0.15 | .X°: ± 2.0° | DL20005(HY)-AWB | PART NO: |
| .XXX: ± 0.01 | .XX°: ± 1.0° | DR:Chen Quan Long | DATE:21/04/03 |
| FINISH: | | CHKD:Wu Hui | DATE:21/04/03 |
| DRAWING NO: | | APPD:Ren An De | DATE:21/04/03 |
| | | UNITS: mm | PAGE: 1/1 |
| | | REV.: A | |

| REV. | REVISION DESCRIPTION | DATE | APPD |
|------|----------------------|------|------|
| | | | |

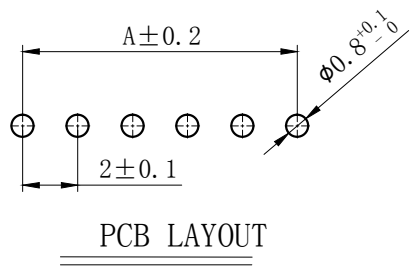
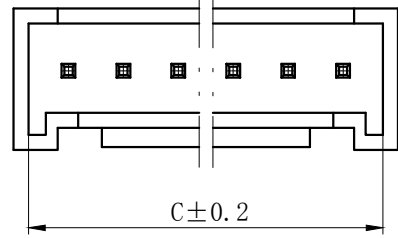
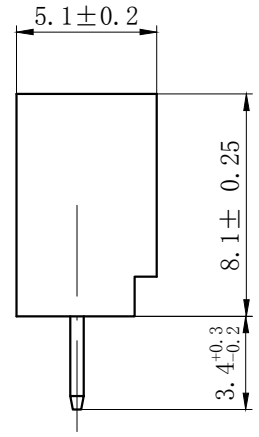
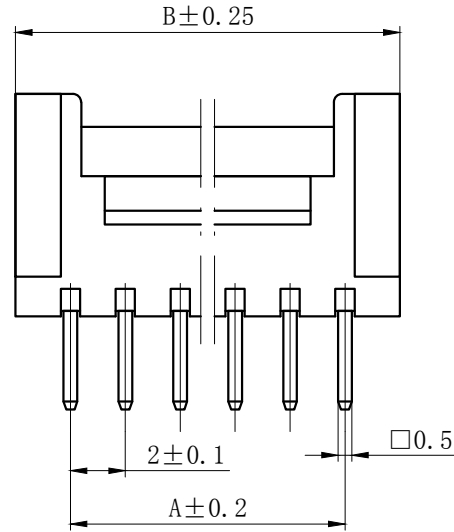
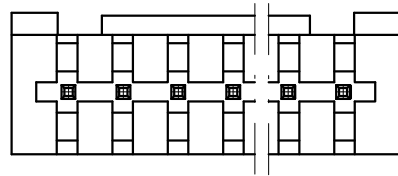

NOTES

Available in 02 through 20 Circuits.
 Mates with DL20005-Y Series Housing.
 Material : Nylon UL94V-0(2).
 0.50mm Square Pin.
 Pin Material : Brass / Tin-Plated.

| Circuits | Product name | Dimension mm | | | Circuits | Product name | Dimension mm | | |
|----------|--------------|--------------|-------|-------|----------|--------------|--------------|-------|-------|
| | | A | B | C | | | A | B | C |
| 2 | HY-2A | 2.00 | 6.00 | 4.90 | 10 | HY-10A | 18.00 | 22.00 | 20.90 |
| 3 | HY-3A | 4.00 | 8.00 | 6.90 | 11 | HY-11A | 20.00 | 24.00 | 22.90 |
| 4 | HY-4A | 6.00 | 10.00 | 8.90 | 12 | HY-12A | 22.00 | 26.00 | 24.90 |
| 5 | HY-5A | 8.00 | 12.00 | 10.90 | 13 | HY-13A | 24.00 | 28.00 | 26.90 |
| 6 | HY-6A | 10.00 | 14.00 | 12.90 | 14 | HY-14A | 26.00 | 30.00 | 28.90 |
| 7 | HY-7A | 12.00 | 16.00 | 14.90 | 15 | HY-15A | 28.00 | 32.00 | 30.90 |
| 8 | HY-8A | 14.00 | 18.00 | 16.90 | - | - | - | - | - |
| 9 | HY-9A | 16.00 | 20.00 | 18.90 | 20 | HY-20A | 38.00 | 42.00 | 40.90 |

| GENERAL TOLERANCES (UNLESS SPECIFIED) | | ZHE JIANG DELI CONNECTORS CO., LTD | | | |
|---------------------------------------|--------------|------------------------------------|----------------|--|--|
| .X: ± 0.25 | X°: ± 3.0° | PRODUCT NAME: | | TITLE: 2.00 mm Pitch Wire To Board Wafer | |
| .XX: ± 0.15 | .X°: ± 2.0° | DL20005 (HY)-A | | PART NO: | |
| .XXX: ± 0.01 | .XX°: ± 1.0° | DR: Chen Quan Long | DATE: 21/08/01 | SCALE: N/A PAGE: 1/1 | |
| FINISH: | | CHKD: Wu Hui | DATE: 21/08/01 | UNITS: mm REV.: A | |
| DRAWING NO: | | APPD: Ren An De | DATE: 21/08/01 | | |

| | | | | | |
|------|---|----------------------|---|------|------|
| REV. | 7 | REVISION DESCRIPTION | 8 | DATE | APPD |
| | | | | | |

NOTES

Available in 02 through 20 Circuits.
 Mates with DL20005-Y Series Housing.
 Material :Nylon UL94V-0(2).
 0.50mm Square Pin.
 Pin Material : Brass / Tin-Plated.

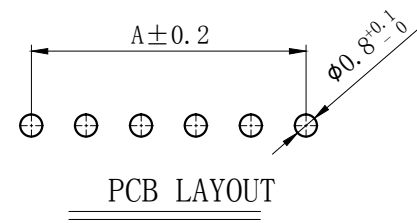
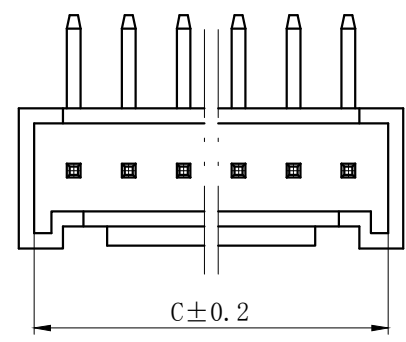
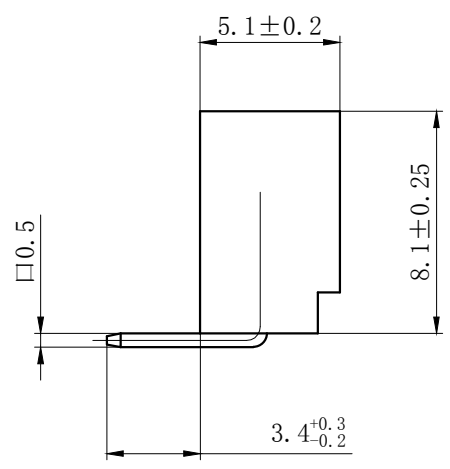
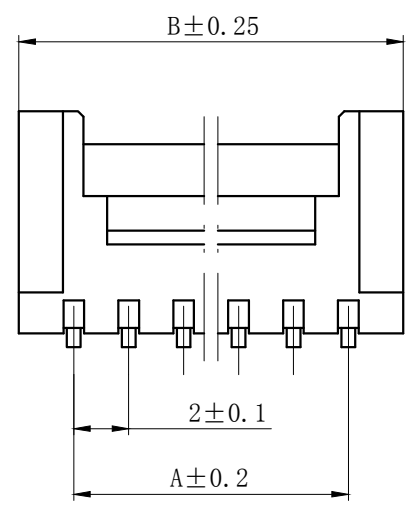
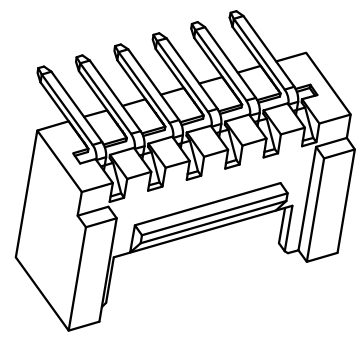
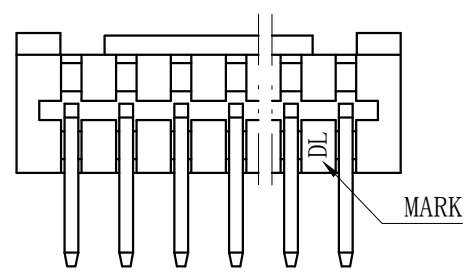

| Circuits | Product name | Dimension mm | | | Circuits | Product name | Dimension mm | | |
|----------|--------------|--------------|-------|-------|----------|--------------|--------------|-------|-------|
| | | A | B | C | | | A | B | C |
| 2 | HY-2AW | 2.00 | 6.00 | 4.90 | 10 | HY-10AW | 18.00 | 22.00 | 20.90 |
| 3 | HY-3AW | 4.00 | 8.00 | 6.90 | 11 | HY-11AW | 20.00 | 24.00 | 22.90 |
| 4 | HY-4AW | 6.00 | 10.00 | 8.90 | 12 | HY-12AW | 22.00 | 26.00 | 24.90 |
| 5 | HY-5AW | 8.00 | 12.00 | 10.90 | 13 | HY-13AW | 24.00 | 28.00 | 26.90 |
| 6 | HY-6AW | 10.00 | 14.00 | 12.90 | 14 | HY-14AW | 26.00 | 30.00 | 28.90 |
| 7 | HY-7AW | 12.00 | 16.00 | 14.90 | 15 | HY-15AW | 28.00 | 32.00 | 30.90 |
| 8 | HY-8AW | 14.00 | 18.00 | 16.90 | - | - | - | - | - |
| 9 | HY-9AW | 16.00 | 20.00 | 18.90 | 20 | HY-20AW | 38.00 | 42.00 | 40.90 |

| | | | | | |
|---------------------------------------|--------------|---|---------------|--|-----------|
| GENERAL TOLERANCES (UNLESS SPECIFIED) | | ZHE JIANG DELI CONNECTORS CO., LTD | | | |
| .X: ± 0.25 | .X°: ± 3.0° | PRODUCT NAME: DL20005 (HY)-AW | | TITLE: 2.00 mm Pitch Wire To Board Wafer | |
| .XX: ± 0.15 | .X°: ± 2.0° | DR:Chen Quan Long | DATE:21/08/01 | PART NO: | |
| .XXX: ± 0.01 | .XX°: ± 1.0° | CHKD:Wu Hui | DATE:21/08/01 | SCALE: N/A | PAGE: 1/1 |
| DRAWING NO: | | APPD:Ren An De | DATE:21/08/01 | UNITS: mm | REV.: A |

| | | | | | |
|------|---|----------------------|---|------|------|
| REV. | 7 | REVISION DESCRIPTION | 8 | DATE | APPD |
| | | | | | |

NOTES

Available in 02 through 20 Circuits.
 Mates with DL20005-Y Series Housing.
 Material :Nylon UL94V-0(2).
 0.50mm Square Pin.
 Pin Material : Brass / Tin-Plated.

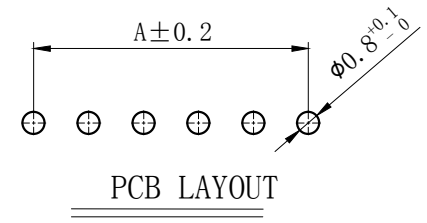
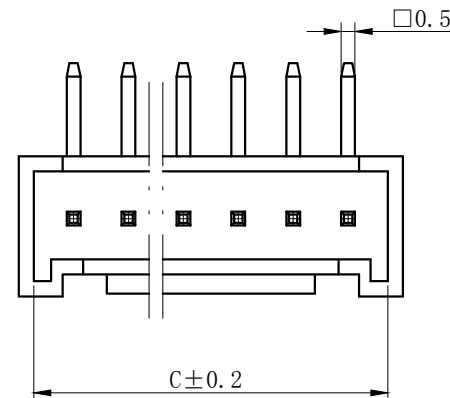
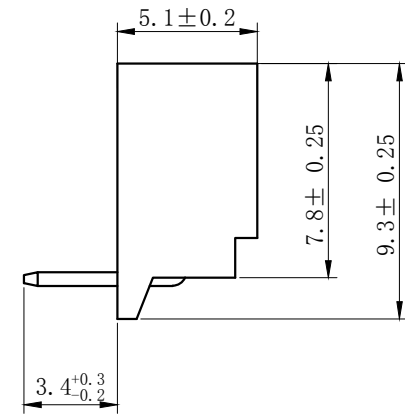
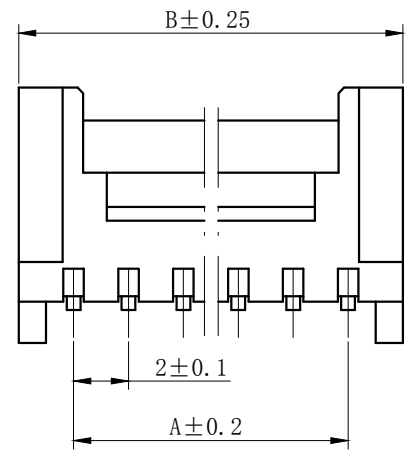
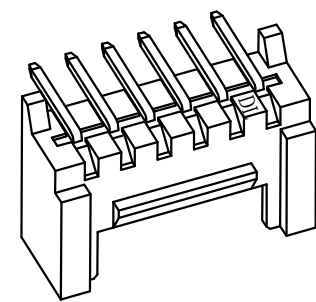
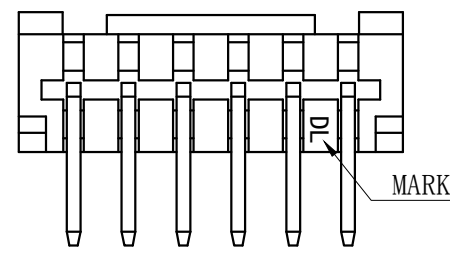

| Circuits | Product name | Dimension mm | | | Circuits | Product name | Dimension mm | | |
|----------|--------------|--------------|-------|-------|----------|--------------|--------------|-------|-------|
| | | A | B | C | | | A | B | C |
| 2 | HY-2AWD | 2.00 | 6.00 | 4.90 | 10 | HY-10AWD | 18.00 | 22.00 | 20.90 |
| 3 | HY-3AWD | 4.00 | 8.00 | 6.90 | 11 | HY-11AWD | 20.00 | 24.00 | 22.90 |
| 4 | HY-4AWD | 6.00 | 10.00 | 8.90 | 12 | HY-12AWD | 22.00 | 26.00 | 24.90 |
| 5 | HY-5AWD | 8.00 | 12.00 | 10.90 | 13 | HY-13AWD | 24.00 | 28.00 | 26.90 |
| 6 | HY-6AWD | 10.00 | 14.00 | 12.90 | 14 | HY-14AWD | 26.00 | 30.00 | 28.90 |
| 7 | HY-7AWD | 12.00 | 16.00 | 14.90 | 15 | HY-15AWD | 28.00 | 32.00 | 30.90 |
| 8 | HY-8AWD | 14.00 | 18.00 | 16.90 | - | - | - | - | - |
| 9 | HY-9AWD | 16.00 | 20.00 | 18.90 | 20 | HY-20AWD | 38.00 | 42.00 | 40.90 |

| | | | | | |
|---------------------------------------|--------------|------------------------------------|---------------|--|-----------|
| GENERAL TOLERANCES (UNLESS SPECIFIED) | | ZHE JIANG DELI CONNECTORS CO., LTD | | | |
| .X: ± 0.25 | X°: ± 3.0° | PRODUCT NAME: DL20005 (HY)-AWD | | TITLE: 2.00 mm Pitch Wire To Board Wafer | |
| .XX: ± 0.15 | .X°: ± 2.0° | DR:Chen Quan Long | DATE:21/08/01 | PART NO: | |
| .XXX: ± 0.01 | .XX°: ± 1.0° | CHKD:Wu Hui | DATE:21/08/01 | SCALE: N/A | PAGE: 1/1 |
| DRAWING NO: | | APPD:Ren An De | DATE:21/08/01 | UNITS: mm | REV.: A |

| | | | |
|------|----------------------|------|------|
| REV. | REVISION DESCRIPTION | DATE | APPD |
| | | | |

NOTES

Available in 02 through 20 Circuits.
 Mates with DL20005-Y Series Housing.
 Material :Nylon UL94V-0(2).
 0.50mm Square Pin.
 Pin Material : Brass / Tin-Plated.

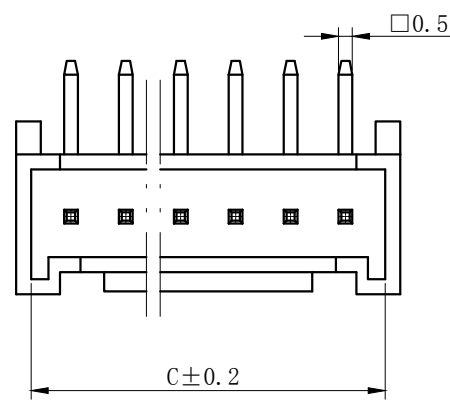
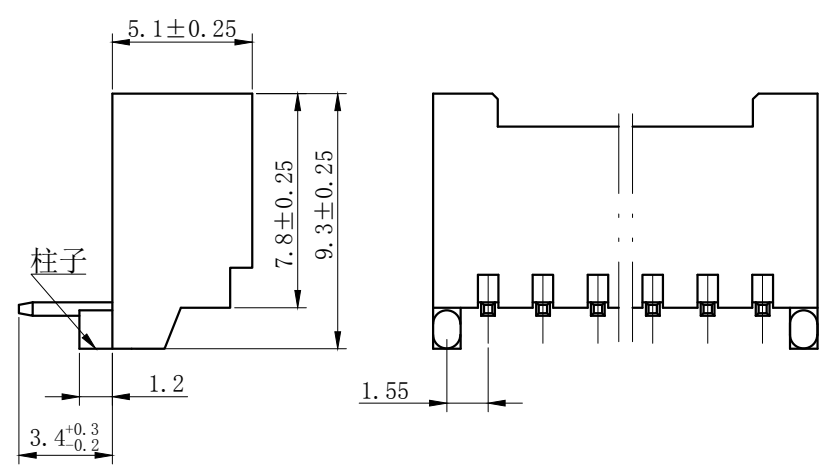
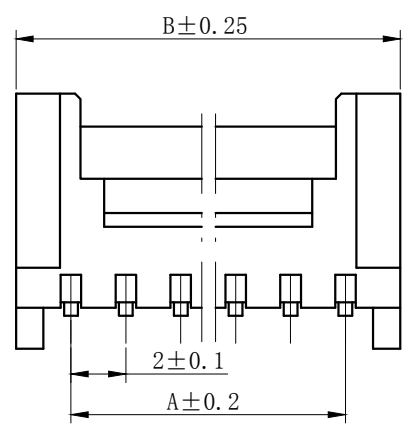
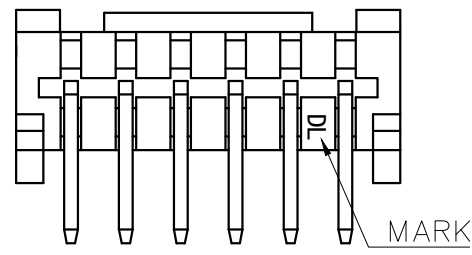

| Circuits | Product name | Dimension mm | | | Circuits | Product name | Dimension mm | | |
|----------|--------------|--------------|-------|-------|----------|--------------|--------------|-------|-------|
| | | A | B | C | | | A | B | C |
| 2 | HY-2AWD-S | 2.00 | 6.00 | 4.90 | 10 | HY-10AWD-S | 18.00 | 22.00 | 20.90 |
| 3 | HY-3AWD-S | 4.00 | 8.00 | 6.90 | 11 | HY-11AWD-S | 20.00 | 24.00 | 22.90 |
| 4 | HY-4AWD-S | 6.00 | 10.00 | 8.90 | 12 | HY-12AWD-S | 22.00 | 26.00 | 24.90 |
| 5 | HY-5AWD-S | 8.00 | 12.00 | 10.90 | 13 | HY-13AWD-S | 24.00 | 28.00 | 26.90 |
| 6 | HY-6AWD-S | 10.00 | 14.00 | 12.90 | 14 | HY-14AWD-S | 26.00 | 30.00 | 28.90 |
| 7 | HY-7AWD-S | 12.00 | 16.00 | 14.90 | 15 | HY-15AWD-S | 28.00 | 32.00 | 30.90 |
| 8 | HY-8AWD-S | 14.00 | 18.00 | 16.90 | - | - | - | - | - |
| 9 | HY-9AWD-S | 16.00 | 20.00 | 18.90 | 20 | HY-20AWD-S | 38.00 | 42.00 | 40.90 |

| | | | |
|---------------------------------------|--------------|-------------------------------------|--|
| GENERAL TOLERANCES (UNLESS SPECIFIED) | | ZHE JIANG DELI CONNECTORS CO., LTD | |
| .X: ± 0.25 | X°: ± 3.0° | PRODUCT NAME: DL20005 (HY)-AWD-S | TITLE: 2.00 mm Pitch Wire To Board Wafer |
| .XX: ± 0.15 | .X°: ± 2.0° | DR:Chen Quan Long | DATE:21/08/01 |
| .XXX: ± 0.01 | .XX°: ± 1.0° | CHKD:Wu Hui | DATE:21/08/01 |
| FINISH: | | APPD:Ren An De | DATE:21/08/01 |
| DRAWING NO: | | | |
| | | SCALE: N/A | PAGE: 1/1 |
| | | UNITS: mm | REV.: A |

| REV. | REVISION DESCRIPTION | DATE | APPD |
|------|----------------------|------|------|
| | | | |

NOTES

Available in 02 through 20 Circuits.
 Mates with DL20038-Y Series Housing.
 Material : Nylon UL94V-0 (2) .
 0.50mm Square Pin.
 Pin Material : Brass / Tin-Plated.

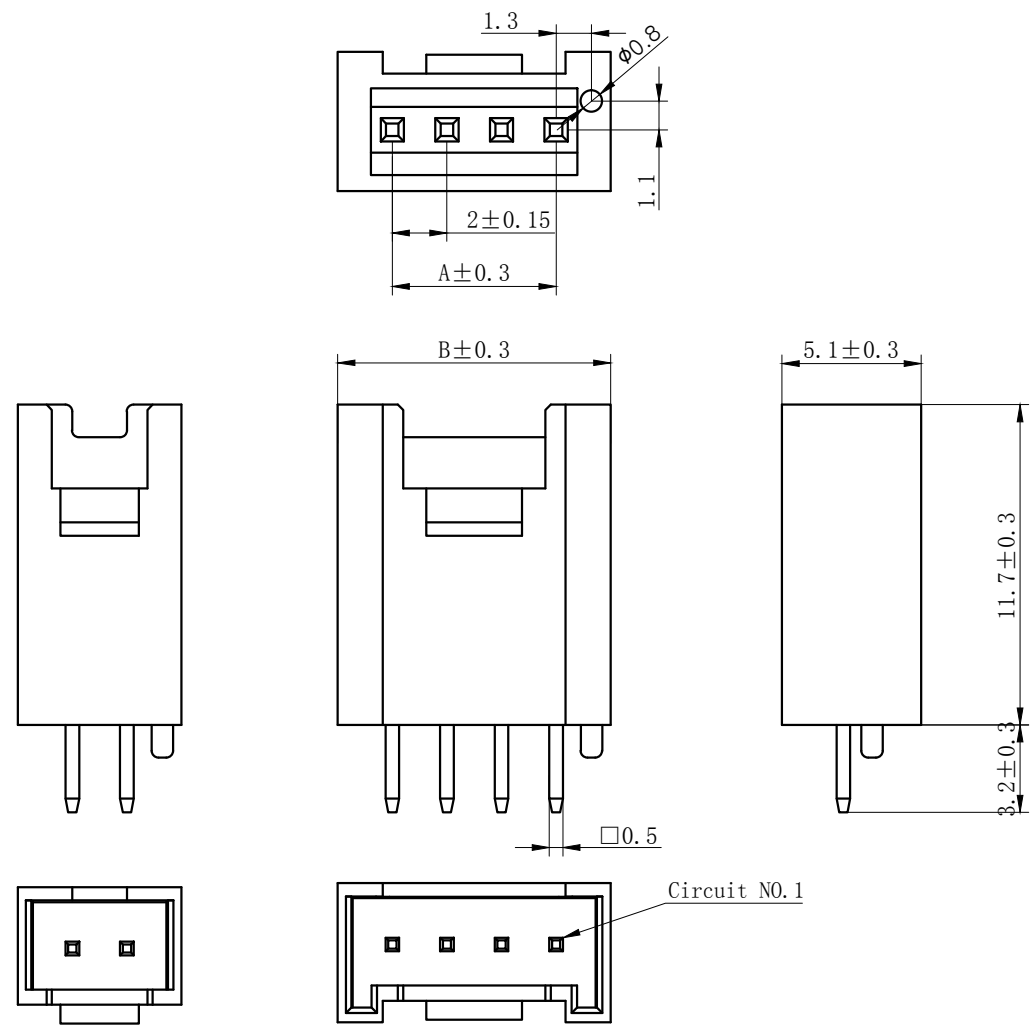

Circuit NO.1

| Circuits | Product name | Dimensino (mm) | | Circuits | Product name | Dimensino (mm) | |
|----------|--------------|----------------|------|----------|--------------|----------------|------|
| | | A | B | | | A | B |
| 2 | HY-H-2AS | 2.0 | 6.0 | 9 | HY-H-9AS | 16.0 | 20.0 |
| 3 | HY-H-3AS | 4.0 | 8.0 | 10 | HY-H-10AS | 18.0 | 22.0 |
| 4 | HY-H-4AS | 6.0 | 10.0 | 11 | HY-H-11AS | 20.0 | 24.0 |
| 5 | HY-H-5AS | 8.0 | 12.0 | 12 | HY-H-12AS | 22.0 | 26.0 |
| 6 | HY-H-6AS | 10.0 | 14.0 | 13 | HY-H-13AS | 24.0 | 28.0 |
| 7 | HY-H-7AS | 12.0 | 16.0 | ~ | ~ | ~ | ~ |
| 8 | HY-H-8AS | 14.0 | 18.0 | 20 | HY-H-20AS | 38.0 | 42.0 |

| GENERAL TOLERANCES (UNLESS SPECIFIED) | | ZHE JIANG DELI CONNECTORS CO., LTD | |
|---------------------------------------|-----------------------|------------------------------------|--|
| .X: ± 0.25 | X°: $\pm 3.0^\circ$ | PRODUCT NAME: | TITLE: 2.00 mm Pitch Wire To Board Wafer |
| .XX: ± 0.15 | .X°: $\pm 2.0^\circ$ | DR: Chen Quan Long | DATE: 22/05/01 |
| .XXX: ± 0.01 | .XX°: $\pm 1.0^\circ$ | DATE: 22/05/01 | PART NO: |
| FINISH: | | CHKD: Wu Hui | DATE: 22/05/01 |
| DRAWING NO: | | APPD: Ren An De | DATE: 22/05/01 |
| | | SCALE: N/A | PAGE: 1/1 |
| | | UNITS: mm | REV.: A |

| | | | |
|------|----------------------|------|------|
| REV. | REVISION DESCRIPTION | DATE | APPD |
| | | | |

NOTES

Available in 02 through 20 Circuits.
 Match with DL20005 series housing
 Material : Nylon UL94V-0(2).
 Accepts DL20005-T Crimp Terminal.

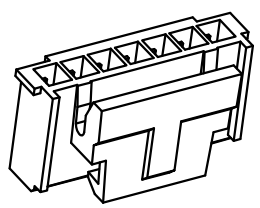
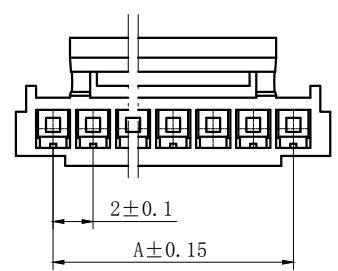
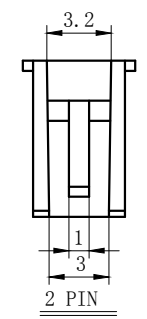
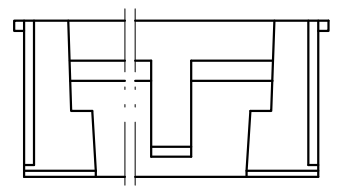
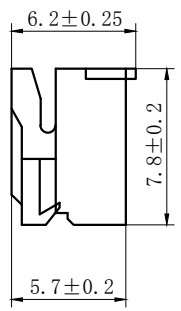
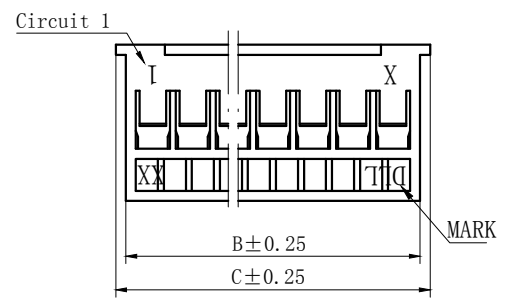
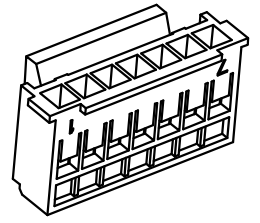
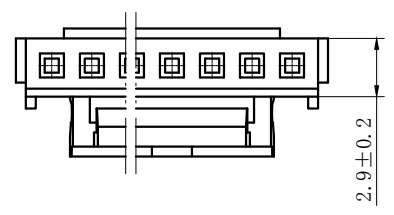

| Circuits | Product name | Dimensino (mm) | | | Circuits | Product name | Dimensino (mm) | | |
|----------|--------------|----------------|-------|-------|----------|--------------|----------------|-------|-------|
| | | A | B | C | | | A | B | C |
| 2 | HY-2Y | 2.00 | 4.60 | 5.60 | 12 | HY-12Y | 22.00 | 24.60 | 25.60 |
| 3 | HY-3Y | 4.00 | 6.60 | 7.60 | 13 | HY-13Y | 24.00 | 26.60 | 27.60 |
| 4 | HY-4Y | 6.00 | 8.60 | 9.60 | 14 | HY-14Y | 26.00 | 28.60 | 29.60 |
| 5 | HY-5Y | 8.00 | 10.60 | 11.60 | 15 | HY-15Y | 28.00 | 30.60 | 31.60 |
| 6 | HY-6Y | 10.00 | 12.60 | 13.60 | 16 | HY-16Y | 30.00 | 32.60 | 33.60 |
| 7 | HY-7Y | 12.00 | 14.60 | 15.60 | 17 | HY-17Y | 32.00 | 34.60 | 35.60 |
| 8 | HY-8Y | 14.00 | 16.60 | 17.60 | 18 | HY-18Y | 34.00 | 36.60 | 37.60 |
| 9 | HY-9Y | 16.00 | 18.60 | 19.60 | 19 | HY-19Y | 36.00 | 38.60 | 39.60 |
| 10 | HY-10Y | 18.00 | 20.60 | 21.60 | 20 | HY-20Y | 38.00 | 40.60 | 41.60 |
| 11 | HY-11Y | 20.00 | 22.60 | 23.60 | - | - | - | - | - |

| | | | |
|---------------------------------------|---------------|------------------------------------|-----------------------|
| GENERAL TOLERANCES (UNLESS SPECIFIED) | | ZHE JIANG DELI CONNECTORS CO., LTD | |
| .X: ± 0.25 | .X°: ± 3.0° | PRODUCT NAME: | TITLE: |
| .XX: ± 0.15 | .XX°: ± 2.0° | DL20005 (HY)-Y | 2.00 mm Pitch Housing |
| .XXX: ± 0.01 | .XXX°: ± 1.0° | DR:Chen Quan Long | DATE:21/08/01 |
| FINISH: | | CHKD: Wu Hui | DATE:21/08/01 |
| DRAWING NO: | | APPD:Ren An De | DATE:21/08/01 |
| | | | PART NO: |
| | | | SCALE: N/A |
| | | | PAGE: 1/1 |
| | | | UNITS: mm |
| | | | REV.: A |

| REV. | REVISION DESCRIPTION | DATE | APPD |
|------|----------------------|------|------|
| | | | |

NOTES

Available in 02 Circuits.
 Match with DL20005 series housing
 Material : Nylon UL94V-0(2).
 Accepts DL20005-T Crimp Terminal.

CIRCUIT NO. 1

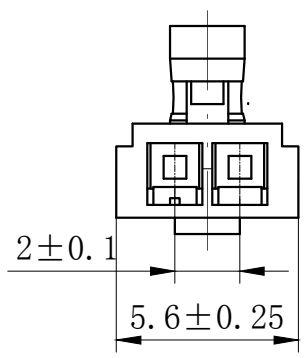
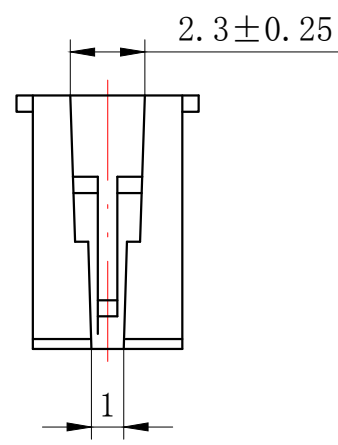
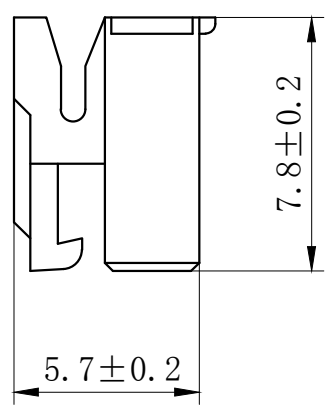
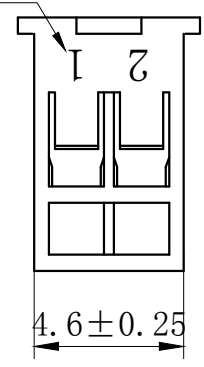

| GENERAL TOLERANCES (UNLESS SPECIFIED) | | ZHE JIANG DELI CONNECTORS CO., LTD | |
|--|---|-------------------------------------|---------------------------------|
| .X: ± 0.25 | X°: ± 3.0° | PRODUCT NAME: DL20005 (HY)-2Y-WJ | TITLE: 2.00 mm Pitch Housing |
| .XX: ± 0.15 | .X°: ± 2.0° | DR: Chen Quan Long | DATE: 21/08/01 |
| .XXX: ± 0.01 | .XX°: ± 1.0° | CHKD: Wu Hui | DATE: 21/08/01 |
| FINISH: |  | APPD: Ren An De | DATE: 21/08/01 |
| DRAWING NO: | | SCALE: N/A | PAGE: 1/1 |
| | | UNITS: mm | REV.: A |

| REV. | 7 | REVISION DESCRIPTION | 8 | DATE | APPD |
|------|---|----------------------|---|------|------|
| | | | | | |

CIRCUIT NO. 1

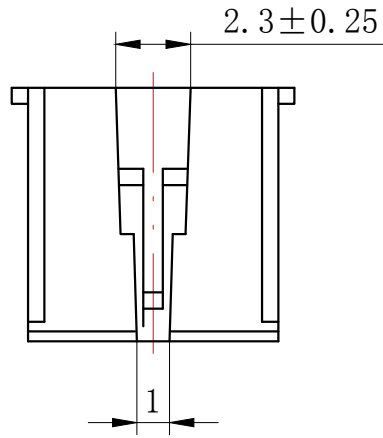
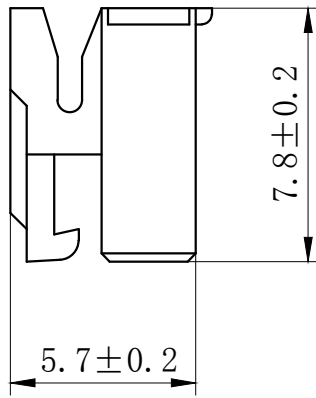
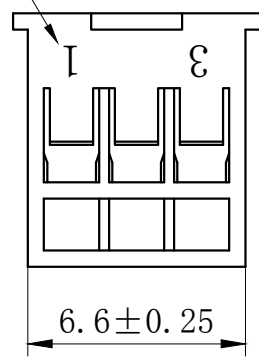

NOTES

Available in 03 Circuits.
 Match with DL20005 series housing
 Material : Nylon UL94V-0 (2).
 Accepts DL20005-T Crimp Terminal.

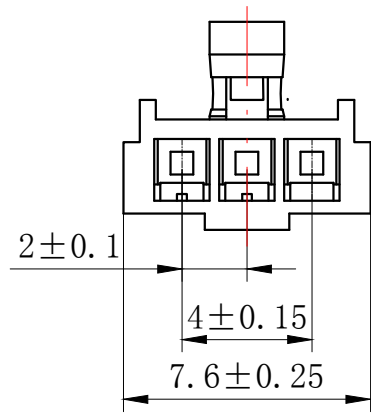

| GENERAL TOLERANCES (UNLESS SPECIFIED) | | ZHE JIANG DELI CONNECTORS CO., LTD | | | |
|--|--------------|--|--|---------------------------------|-----------|
| .X: ± 0.25 | X°: ± 3.0° | PRODUCT NAME: DL20005 (HY)-3Y-WJ | | TITLE: 2.00 mm Pitch Housing | |
| .XX: ± 0.15 | .X°: ± 2.0° | DR:Chen Quan Long | | DATE:21/08/01 | |
| .XXX: ± 0.01 | .XX°: ± 1.0° | CHKD: Wu Hui | | DATE:21/08/01 | |
| DRAWING NO: | | APPD:Ren An De | | SCALE: N/A | PAGE: 1/1 |
| | | DATE:21/08/01 | | UNITS: mm | REV.: A |

| REV. | REVISION DESCRIPTION | DATE | APPD |
|------|----------------------|------|------|
| | | | |

NOTES

Available in 04 through 20 Circuits.
 Match with DL20005 series housing
 Material : Nylon UL94V-0(2).
 Accepts DL20005-T Crimp Terminal.

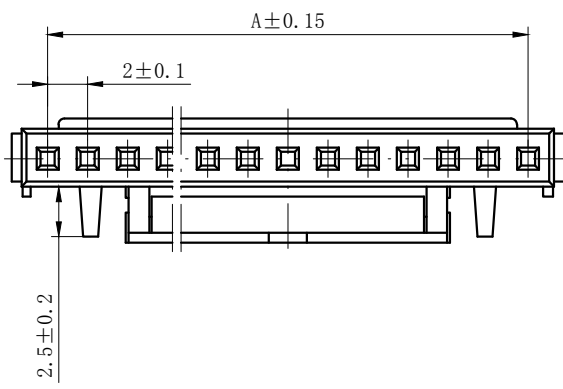
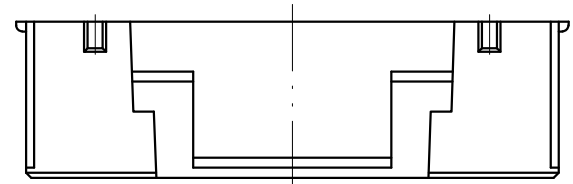
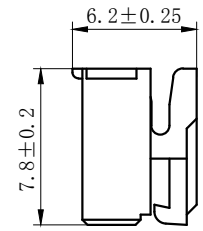
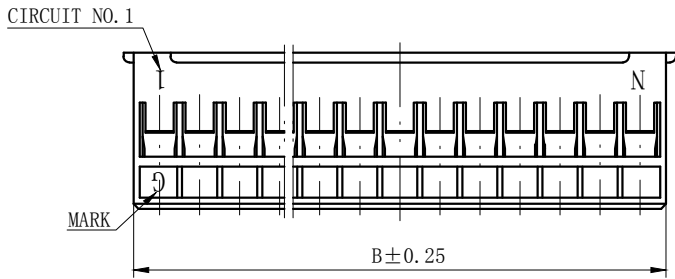
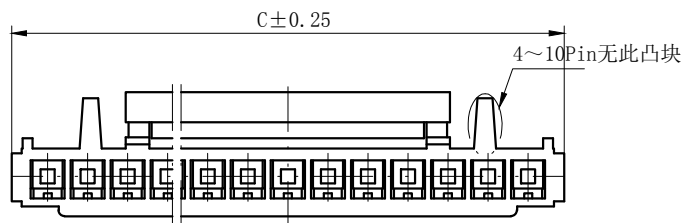

| Circuits | Product name | Dimension mm | | | Circuits | Product name | Dimension mm | | |
|----------|--------------|--------------|-------|-------|----------|--------------|--------------|-------|-------|
| | | A | B | C | | | A | B | C |
| 4 | HY-4Y-WJ | 6.00 | 8.60 | 9.60 | 11 | HY-11Y-WJ | 20.00 | 22.60 | 23.60 |
| 5 | HY-5Y-WJ | 8.00 | 10.60 | 11.60 | 12 | HY-12Y-WJ | 22.00 | 24.60 | 25.60 |
| 6 | HY-6Y-WJ | 10.00 | 12.60 | 13.60 | 13 | HY-13Y-WJ | 24.00 | 26.60 | 27.60 |
| 7 | HY-7Y-WJ | 12.00 | 14.60 | 15.60 | 14 | HY-14Y-WJ | 26.00 | 28.60 | 29.60 |
| 8 | HY-8Y-WJ | 14.00 | 16.60 | 17.60 | 15 | HY-15Y-WJ | 28.00 | 30.60 | 31.60 |
| 9 | HY-9Y-WJ | 16.00 | 18.60 | 19.60 | ~ | ~ | ~ | ~ | ~ |
| 10 | HY-10Y-WJ | 18.00 | 20.60 | 21.60 | 20 | HY-20Y-WJ | 38.00 | 40.60 | 41.60 |

| GENERAL TOLERANCES (UNLESS SPECIFIED) | | ZHE JIANG DELI CONNECTORS CO., LTD | |
|---------------------------------------|---------------|------------------------------------|-----------------------|
| .X: ± 0.25 | .X°: ± 3.0° | PRODUCT NAME: | TITLE: |
| .XX: ± 0.15 | .XX°: ± 2.0° | DL20005 (HY)-Y-WJ | 2.00 mm Pitch Housing |
| .XXX: ± 0.01 | .XXX°: ± 1.0° | DR:Chen Quan Long | DATE:21/08/01 |
| FINISH: | | CHKD: Wu Hui | DATE:21/08/01 |
| DRAWING NO: | | APPD:Ren An De | DATE:21/08/01 |
| | | | PART NO: |
| | | | SCALE: N/A |
| | | | PAGE: 1/1 |
| | | | UNITS: mm |
| | | | REV.: A |

| | | | |
|------|----------------------|------|------|
| REV. | REVISION DESCRIPTION | DATE | APPD |
| | | | |

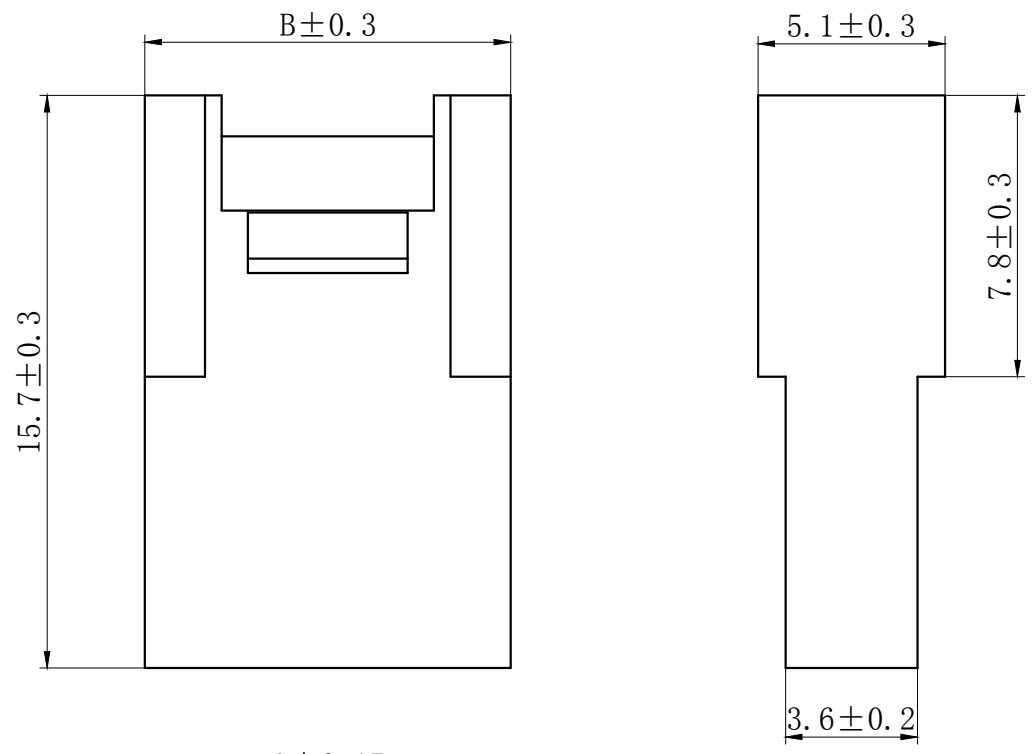

NOTES

Available in 02 through 20 Circuits.
 Mates with DL20005-Y Series Housing.
 Material : Nylon UL94V-0(2).
 Accepts DL20005-RT Crimp Terminal.

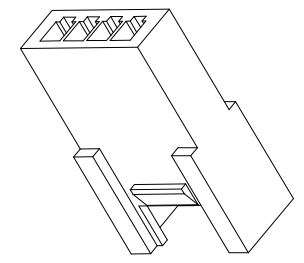
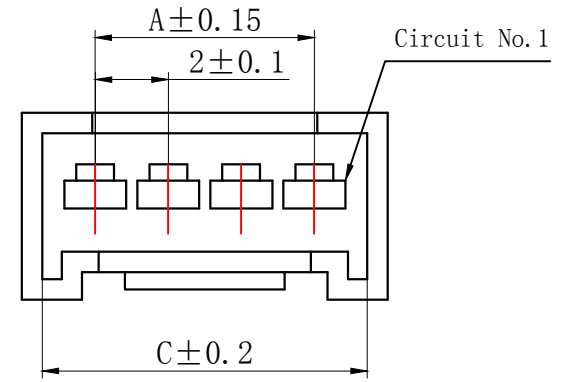

| Circuits | Product name | Dimension mm | | | Circuits | Product name | Dimension mm | | |
|----------|--------------|--------------|-------|------|----------|--------------|--------------|-------|------|
| | | A | B | C | | | A | B | C |
| 2 | HY-2R | 2.00 | 6.00 | 4.9 | 10 | HY-10R | 18.00 | 22.00 | 20.9 |
| 3 | HY-3R | 4.00 | 8.00 | 6.9 | 11 | HY-11R | 20.00 | 24.00 | 22.9 |
| 4 | HY-4R | 6.00 | 10.00 | 8.9 | 12 | HY-12R | 22.00 | 26.00 | 24.9 |
| 5 | HY-5R | 8.00 | 12.00 | 10.9 | 13 | HY-13R | 24.00 | 28.00 | 26.9 |
| 6 | HY-6R | 10.00 | 14.00 | 12.9 | 14 | HY-14R | 26.00 | 30.00 | 28.9 |
| 7 | HY-7R | 12.00 | 16.00 | 14.9 | 15 | HY-15R | 28.00 | 32.00 | 30.9 |
| 8 | HY-8R | 14.00 | 18.00 | 16.9 | ~ | ~ | ~ | ~ | ~ |
| 9 | HY-9R | 16.00 | 20.00 | 18.9 | 20 | HY-20R | 38.00 | 42.00 | 40.9 |

| | | | |
|---------------------------------------|--------------|---|---------------|
| GENERAL TOLERANCES (UNLESS SPECIFIED) | | ZHE JIANG DELI CONNECTORS CO., LTD | |
| .X: ± 0.25 | X°: ± 3.0° | TITLE: 2.00 mm Pitch Wire To Wire Housing | |
| .XX: ± 0.15 | .X°: ± 2.0° | | |
| .XXX: ± 0.01 | .XX°: ± 1.0° | DR: Chen Quan Long | DATE:20/10/12 |
| FINISH: | | CHKD: Wu Hui | DATE:20/10/12 |
| DRAWING NO: | | APPD:Ren An De | DATE:20/10/12 |
| | | SCALE: N/A | PAGE: 1/1 |
| | | UNITS: mm | REV.: A |

| REV. | REVISION DESCRIPTION | DATE | APPD |
|------|----------------------|------|------|
| | | | |

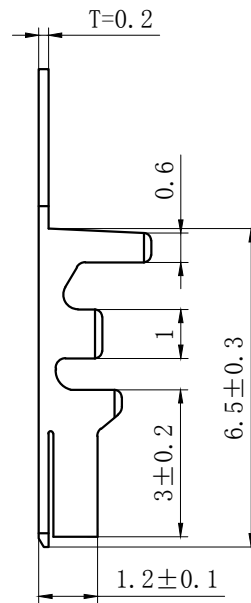
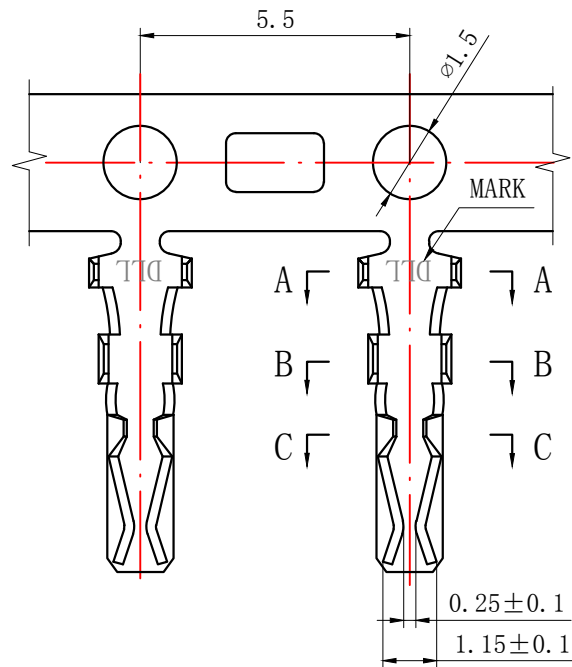

NOTES

- Used in DL20005-Y Series Housing.
- Accepts AWG #28~22 Wire Range.
0.05~ 0.33 mm².
- Insulation O.D.=0.9~1.8 mm.
- Material : Phosphor Bronze .
- Finish: Tin plated.
- Thickness: 0.2 mm.

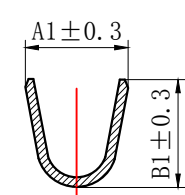

SECTION A-A

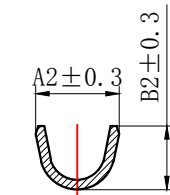

SECTION B-B

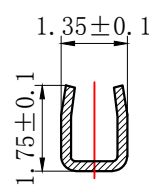

SECTION C-C

| TYPE | Dimension mm | | | | 适用线规AWG |
|--------|--------------|-----|-----|-----|---------|
| | A1 | B1 | A2 | B2 | |
| HY-T-G | 2.1 | 2.2 | 1.7 | 1.7 | #24-22 |
| HY-T | 2.1 | 2.2 | 1.7 | 1.3 | #26-24 |
| HY-T-D | 1.7 | 1.7 | 1.3 | 1.2 | #28-26 |

| | | | |
|--|--------------|------------------------------------|---|
| GENERAL TOLERANCES (UNLESS SPECIFIED) | | ZHE JIANG DELI CONNECTORS CO., LTD | |
| .X: ± 0.25 | X°: ± 3.0° | PRODUCT NAME: DL20005(HY)-T | TITLE: 2.00 mm Pitch Crimp Terminal |
| .XX: ± 0.15 | .X°: ± 2.0° | DR: Chen Quan Long | DATE: 21/03/13 |
| .XXX: ± 0.01 | .XX°: ± 1.0° | CHKD: Wu Hui | DATE: 21/03/13 |
| FINISH: | | APPD: Ren An De | DATE: 21/03/13 |
| DRAWING NO: | | | |
| | | SCALE: N/A | PAGE: 1/1 |
| | | UNITS: mm | REV.: A |

| REV. | REVISION DESCRIPTION | DATE | APPD |
|------|----------------------|------|------|
| | | | |

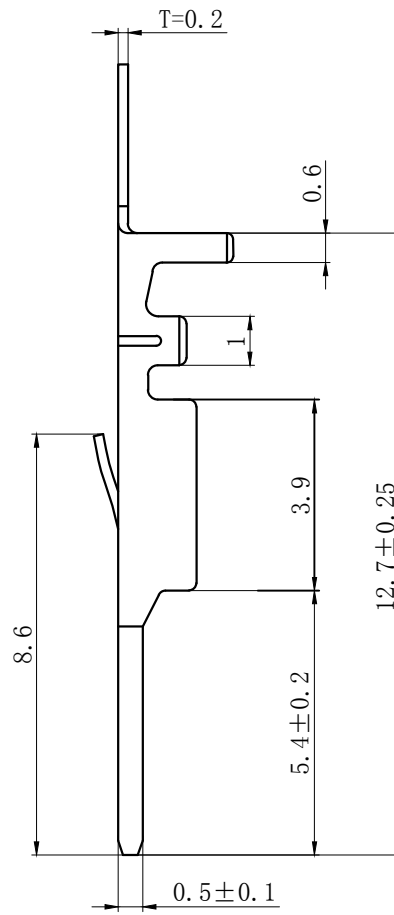
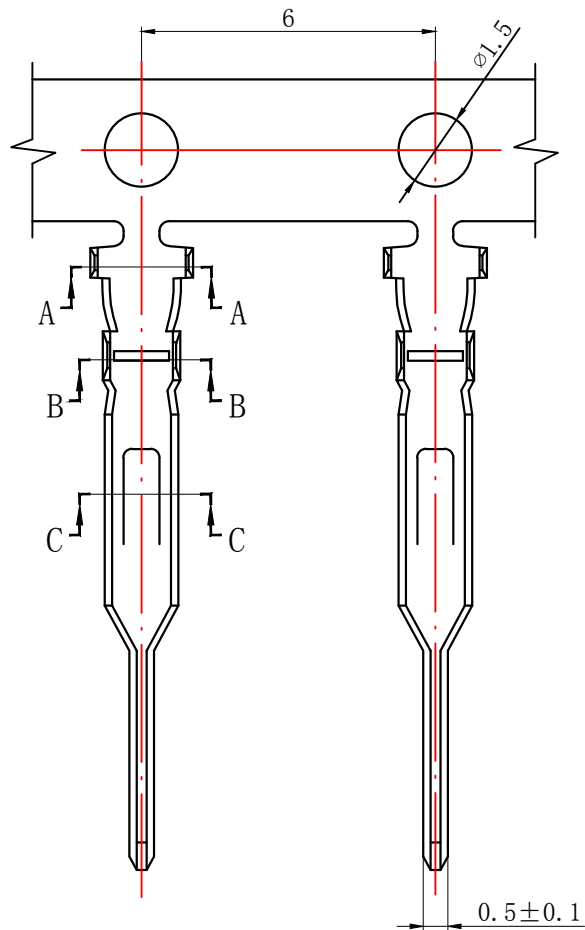

NOTES

Used in DL20005-R Series Housing.
Accepts AWG #28~22 Wire Range.

0.08~ 0.33 mm² .

Insulation O.D. =0.9~1.8mm.

Material : Phosphor Bronze .

Finish: Tin plated.

Thickness: 0.2 mm.

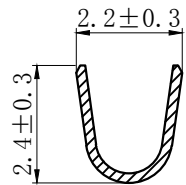

SECTION A-A

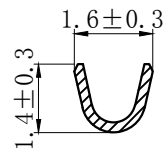

SECTION B-B

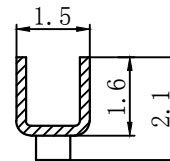

SECTION C-C

| GENERAL TOLERANCES (UNLESS SPECIFIED) | | | | ZHE JIANG DELI CONNECTORS CO ., LTD | | | |
|--|---------------|--|---------------|--|--|-----------|--|
| .X: ± 0.25 | X° : ± 3.0° | PRODUCT NAME: DL20005 (HY) -RT | | TITLE: 2.00 mm Pitch Wire To Wire Crimp Terminal | | PART NO: | |
| .XX: ± 0.15 | .X° : ± 2.0° | DR:Chen Quan Long | DATE:20/12/30 | SCALE: N/A | | PAGE: 1/1 | |
| .XXX: ± 0.01 | .XX° : ± 1.0° | CHKD: Wu Hui | DATE:20/12/30 | UNITS: mm | | REV.: A | |
| DRAWING NO: | | APPD:Ren An De | DATE:20/12/30 | | | | |

X-ON Electronics

Largest Supplier of Electrical and Electronic Components

Click to view similar products for [Headers & Wire Housings](#) category:

Click to view products by [DLL](#) manufacturer:

Other Similar products are found below :

[0015917161](#) [0022155065](#) [57102-F02-18ULF](#) [58102-G61-06LF](#) [582553-1](#) [01.001.5753.1](#) [0050291907](#) [02.125.8002.8](#) [609-3404](#) [61062-3](#)
[CSU011177004](#) [622-0430](#) [622-3653LF](#) [63453-116](#) [636-1030](#) [636-1427](#) [636-3427](#) [636-4007](#) [641938-9](#) [65495-038](#) [65692-001LF](#) [65781-018](#)
[65781-047](#) [65817-010LF](#) [65817-015LF](#) [67095-007LF](#) [67601157](#) [68631-112](#) [68645-018](#) [699319-000](#) [70.362.1628.0](#) [70-4210](#) [70-4226B](#) [70-](#)
[4853B](#) [71.350.2428.0](#) [733-134](#) [733-162](#) [760-3052](#) [MHR-64-VUAL](#) [80.063.4001.1](#) [800-90-001-10-001000](#) [801-43-002-10-013000](#)
[801-43-006-10-002000](#) [803-43-024-10-001000](#) [803-93-012-10-001000](#) [8-1437020-4](#) [819-22-004-30-001101](#) [820-22-006-30-001101](#)
[820-22-008-30-001101](#) [821-22-002-10-001101](#)