

**技术特性/Specifications:**

额定电压 Rated voltage: 250V AC, DC  
额定电流 Rated current: 2A AC, DC  
接触电阻 Contact resistance: 20m $\Omega$  max  
绝缘电阻 Insulation resistance: 1000M $\Omega$  min  
耐压 Withstand voltage: 800V AC/minute  
环境温度 Ambient temperature: -40 $^{\circ}$ C~+105 $^{\circ}$ C  
适用线规 Wire range: AWG#30~#24

REV.	REVISION DESCRIPTION	DATE	APPD

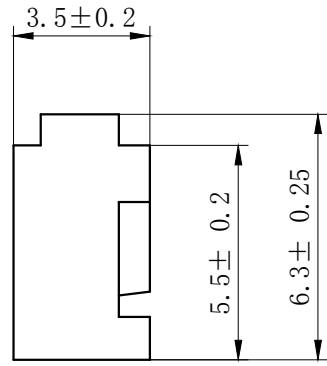
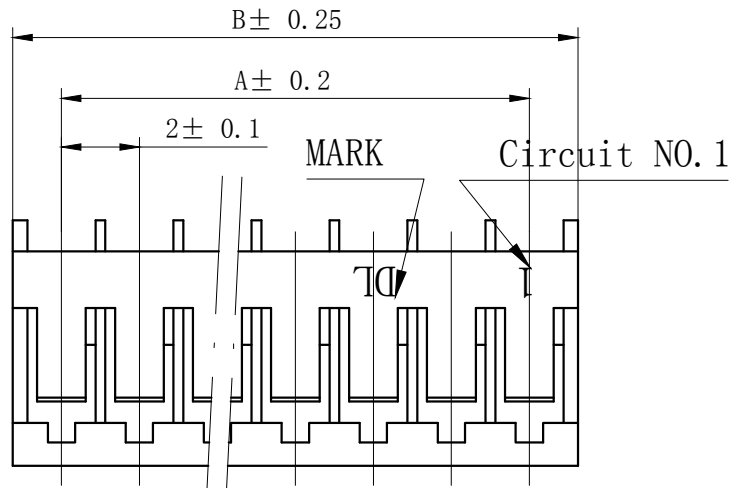

## NOTES

Available in 02 through 16 Circuits.  
 Material : Nylon UL94V-0(2).  
 Accepts DL20011-T Crimp Terminal.

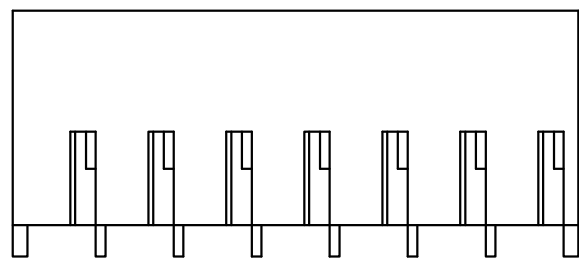
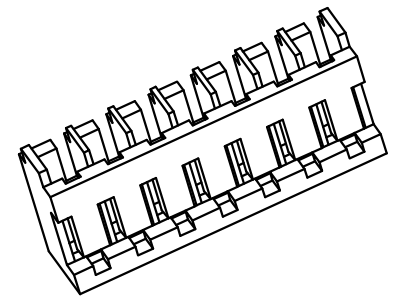
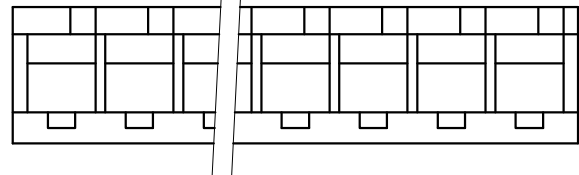

Circuits	Product name	Dimension mm		Circuits	Product name	Dimension mm	
		A	B			A	B
2	JC20-2Y	2.00	4.50	10	JC20-10Y	18.00	20.50
3	JC20-3Y	4.00	6.50	11	JC20-11Y	20.00	22.50
4	JC20-4Y	6.00	8.50	12	JC20-12Y	22.00	24.50
5	JC20-5Y	8.00	10.50	13	JC20-13Y	24.00	26.50
6	JC20-6Y	10.00	12.50	14	JC20-14Y	26.00	28.50
7	JC20-7Y	12.00	14.50	15	JC20-15Y	28.00	30.50
8	JC20-8Y	14.00	16.50	16	JC20-16Y	30.00	32.50
9	JC20-9Y	16.00	18.50	-	-	-	-

GENERAL TOLERANCES (UNLESS SPECIFIED)		ZHE JIANG DELI CONNECTORS CO., LTD			
.X: ± 0.25	X° : ± 3.0°	PRODUCT NAME: DL20011 (JC20)-Y		TITLE: 2.00 mm Pitch Wire To Board Housing	
.XX: ± 0.15	.X° : ± 2.0°	DR: Yuan Jun Rong		DATE: 21/08/01	
.XXX: ± 0.01	.XX° : ± 1.0°	FINISH:		PART NO:	
DRAWING NO:		CHKD: Wu Hui	DATE: 21/08/01	SCALE: N/A	PAGE: 1/1
		APPD: Ren An De	DATE: 21/08/01	UNITS: mm	REV.: A

REV.	REVISION DESCRIPTION	DATE	APPD

### NOTES

Used in DL20011-Y Series Housing.  
 Accepts AWG #30~24 Wire Range.  
 $0.05 \sim 0.22 \text{ mm}^2$ .  
 Insulation O.D.= $0.9 \sim 1.4 \text{ mm}$ .  
 Material : Phosphor Bronze .  
 Finish: Tin plated  $2.0 \mu\text{m Min}$  .  
 Thickness:  $0.2 \text{ mm}$ .

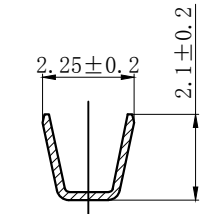
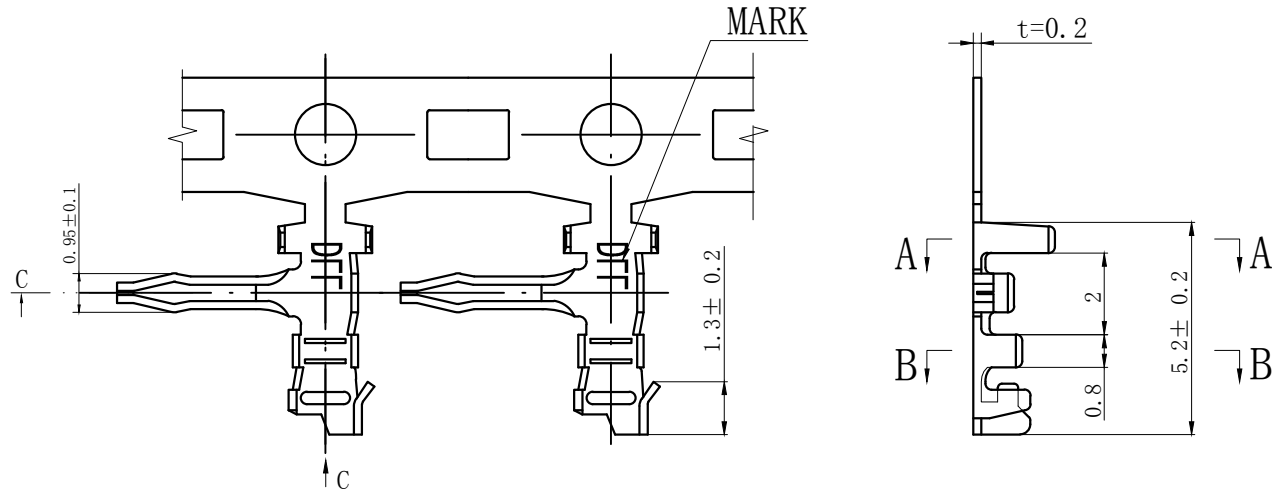

SECTION A-A

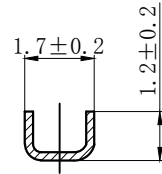

SECTION B-B

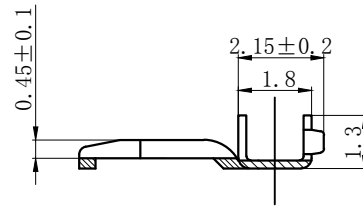

SECTION C-C

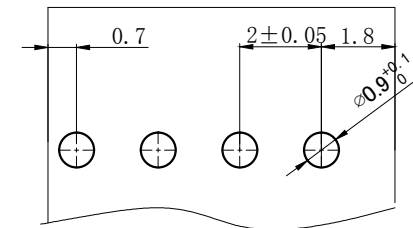

PCB LAYOUT

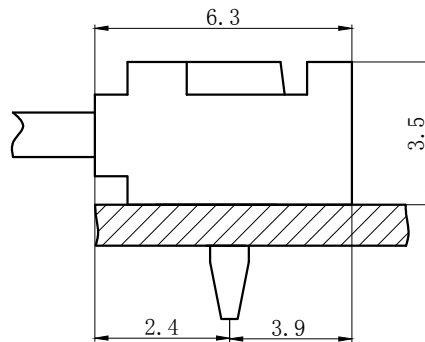

GENERAL TOLERANCES (UNLESS SPECIFIED)		ZHE JIANG DELI CONNECTORS CO., LTD	
.X: ± 0.25	X°: ± 3.0°	PRODUCT NAME:	TITLE:
.XX: ± 0.15	.X°: ± 2.0°	DL20011(JC20)-T	2.00 mm Pitch Wire To Board Crimp Terminal
.XXX: ± 0.01	.XX°: ± 1.0°	DR: Yuan Jun Rong	DATE: 21/08/01
FINISH:		CHKD: Wu Hui	DATE: 21/08/01
DRAWING NO:		APPD: Ren An De	DATE: 21/08/01
			PART NO:
			SCALE: N/A
			PAGE: 1/1
			UNITS: mm
			REV.: A

## X-ON Electronics

Largest Supplier of Electrical and Electronic Components

*Click to view similar products for [Headers & Wire Housings](#) category:*

*Click to view products by [DLL](#) manufacturer:*

Other Similar products are found below :

[0015917161](#) [0022155065](#) [57102-F02-18ULF](#) [58102-G61-06LF](#) [582553-1](#) [01.001.5753.1](#) [0050291907](#) [02.125.8002.8](#) [609-3404](#) [61062-3](#)  
[CSU011177004](#) [622-0430](#) [622-3653LF](#) [63453-116](#) [636-1030](#) [636-1427](#) [636-3427](#) [636-4007](#) [641938-9](#) [65495-038](#) [65692-001LF](#) [65781-018](#)  
[65781-047](#) [65817-010LF](#) [65817-015LF](#) [67095-007LF](#) [67601157](#) [68631-112](#) [68645-018](#) [699319-000](#) [70.362.1628.0](#) [70-4210](#) [70-4226B](#) [70-](#)  
[4853B](#) [71.350.2428.0](#) [733-134](#) [733-162](#) [MHR-64-VUAL](#) [80.063.4001.1](#) [800-90-001-10-001000](#) [801-43-002-10-013000](#) [801-43-006-10-](#)  
[002000](#) [803-43-024-10-001000](#) [803-93-012-10-001000](#) [8-1437020-4](#) [819-22-004-30-001101](#) [820-22-006-30-001101](#) [820-22-008-30-001101](#)  
[821-22-002-10-001101](#) [821-22-003-10-002101](#)