



技术特性/Specifications:

额定电压 Rated voltage: 250V AC, DC
额定电流 Rated current: 3A AC, DC
接触电阻 Contact resistance: 20mΩ max
绝缘电阻 Insulation resistance: 1000MΩ min
耐压 Withstand voltage: 800V AC/minute
环境温度 Ambient temperature: -40°C~+105°C
适用线规 Wire range: AWG#28~#22

REV.	REVISION DESCRIPTION	DATE

技术特性/Specifications:

额定电流 Rated current: 3A AC\DC
 额定电压 Rated voltage: 250V AC\DC
 接触电阻 Contact resistance: 20mΩ max
 绝缘电阻 Insulation resistance: 1000MΩ min
 耐压 Withstand voltage: 800V AC/ minute
 环境温度 Ambient temperature: -40℃ to 105℃
 材料/Materials:
 针座Wafer: LCP UL94V-0
 铜针Pin Material: 黄铜Brass / Tin-Plated.

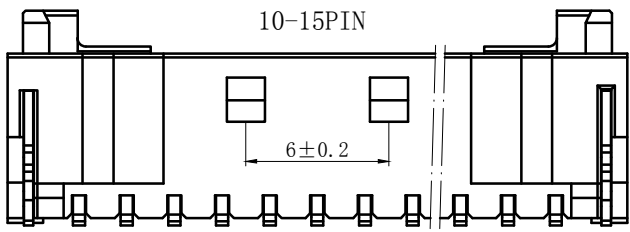
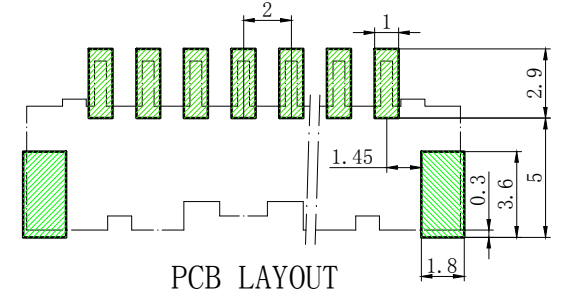
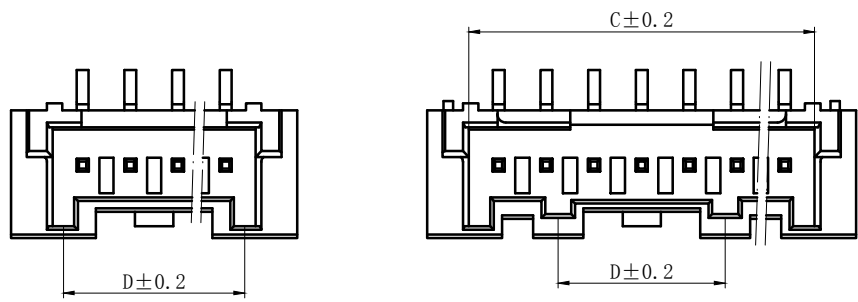
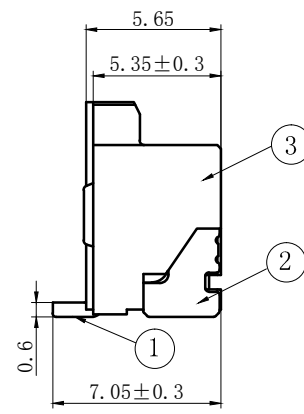
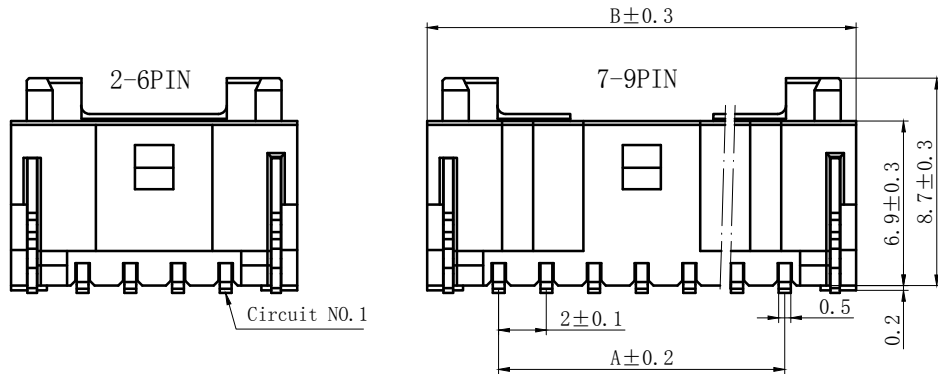

3	③	基座	LCP	1	UL94V-0
2	②	焊片	黄铜	2	镀锡
1	①	接触件	黄铜	N*	镀锡
序号	图号	名称	材料	数量	附件

Circ uits	Product name	Dimension mm				Circ uits	Product name	Dimension mm			
		A	B	C	D			A	B	C	D
2	PA-2AB	2.00	8.00	4.50	3.60	10	PA-10AB	18.00	24.00	20.50	13.60
3	PA-3AB	4.00	10.00	6.50	5.60	11	PA-11AB	20.00	26.00	22.50	13.60
4	PA-4AB	6.00	12.00	8.50	7.60	12	PA-12AB	22.00	28.00	24.50	13.60
5	PA-5AB	8.00	14.00	10.50	7.00	13	PA-13AB	24.00	30.00	26.50	13.60
6	PA-6AB	10.00	16.00	12.50	7.00	14	PA-14AB	26.00	32.00	28.50	13.60
7	PA-7AB	12.00	18.00	14.50	7.00	15	PA-15AB	28.00	34.00	30.50	13.60
8	PA-8AB	14.00	20.00	16.50	7.00	16	PA-16AB	30.00	36.00	32.50	13.60
9	PA-9AB	16.00	22.00	18.50	7.00	-	-	-	-	-	-

GENERAL TOLERANCES (UNLESS SPECIFIED)				ZHE JIANG DELI CONNECTORS CO.,LTD			
.X: ± 0.25	X°: ± 3.0°	PRODUCT NAME: DL20003 (PA)-AB		TITLE: 2.00 mm Pitch Wire To Board SMT Wafer			
.XX: ± 0.15	.X°: ± 2.0°	DR: Chen Quan Long	DATE: 19/04/03	PART NO:			
.XXX: ± 0.01	.XX°: ± 1.0°	CHKD: Wu Hui	DATE: 19/04/03	SCALE: N/A	PAGE: 1/1		
FINISH:		APPD: Ren An De	DATE: 19/04/03	UNITS: mm	REV.: A		
DRAWING NO:							

REV.	REVISION DESCRIPTION	DATE

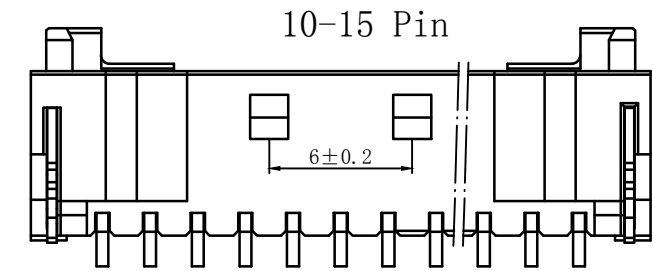
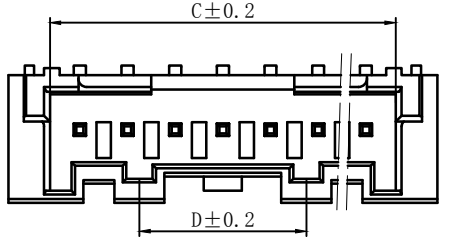
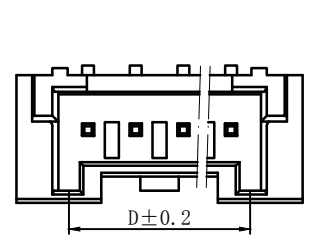

技术特性/Specifications:
 额定电流 Rated current: 3A AC\DC
 额定电压 Rated voltage: 250V AC\DC
 接触电阻 Contact resistance: 20mΩ max
 绝缘电阻 Insulation resistance: 1000MΩ min
 耐压 Withstand voltage: 800V AC/ minute
 环境温度 Ambient temperature: -40°C to 105°C
 材料/Materials:
 针座Wafer: LCP UL94V-0
 铜针Pin Material : 黄铜Brass / Tin-Plated.

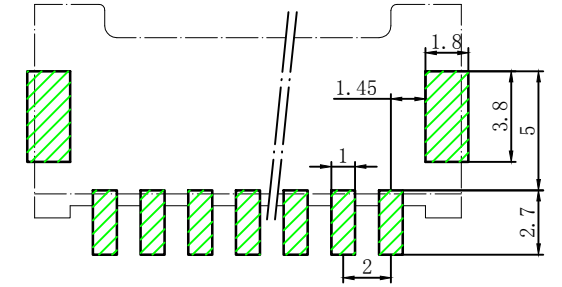

PCB LAYOUT

3	③	基座	LCP	1	UL94V-0
2	②	焊片	黄铜	2	镀锡
1	①	接触件	黄铜	N*	镀锡
序号	图号	名称	材料	数量	附件

Circuits	Product name	Dimension mm				Circuits	Product name	Dimension mm			
		A	B	C	D			A	B	C	D
2	PA-2AWB	2.00	8.00	4.50	3.60	10	PA-10AWB	18.00	24.00	20.50	13.60
3	PA-3AWB	4.00	10.00	6.50	5.60	11	PA-11AWB	20.00	26.00	22.50	13.60
4	PA-4AWB	6.00	12.00	8.50	7.60	12	PA-12AWB	22.00	28.00	24.50	13.60
5	PA-5AWB	8.00	14.00	10.50	7.00	13	PA-13AWB	24.00	30.00	26.50	13.60
6	PA-6AWB	10.00	16.00	12.50	7.00	14	PA-14AWB	26.00	32.00	28.50	13.60
7	PA-7AWB	12.00	18.00	14.50	7.00	15	PA-15AWB	28.00	34.00	30.50	13.60
8	PA-8AWB	14.00	20.00	16.50	7.00	16	PA-16AWB	30.00	36.00	32.50	13.60
9	PA-9AWB	16.00	22.00	18.50	7.00	-	-	-	-	-	-

GENERAL TOLERANCES (UNLESS SPECIFIED)		ZHE JIANG DELI CONNECTORS CO.,LTD			
.X: ± 0.25	X° : ± 3.0°	PRODUCT NAME: DL20003 (PA)-AWB		TITLE: 2.00 mm Pitch Wire To Board SMT Wafer	
.XX: ± 0.15	.X° : ± 2.0°	DR: Chen Quan Long	DATE: 19/04/03	PART NO:	
.XXX: ± 0.01	.XX° : ± 1.0°	FINISH:	CHKD: Wu Hui	DATE: 19/04/03	SCALE: N/A
DRAWING NO:		APPD: Ren An De	DATE: 19/04/03	UNITS: mm	PAGE: 1/1
				REV.: A	

REV.	REVISION DESCRIPTION	DATE	APPD

NOTES

Available in 02 through 16 Circuits.
 Mates with DL20003-Y Series Housing.
 Material : Nylon UL94V-0 (2) .
 0.50mm Square Pin.
 Pin Material : Brass / Tin-Plated.

2PIN



4-9PIN



3PIN



10PIN以上

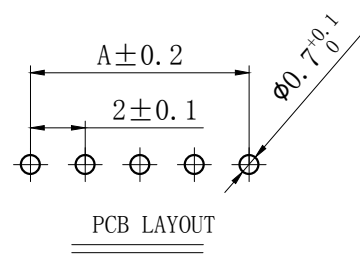

Circuits	Product name	Dimensino (mm)			Circuits	Product name	Dimensino (mm)		
		A	B	C			A	B	C
2	PA-2A	2.00	6.00	4.80	10	PA-10A	18.00	22.00	20.80
3	PA-3A	4.00	8.00	6.80	11	PA-11A	20.00	24.00	22.80
4	PA-4A	6.00	10.00	8.80	12	PA-12A	22.00	26.00	24.80
5	PA-5A	8.00	12.00	10.80	13	PA-13A	24.00	28.00	26.80
6	PA-6A	10.00	14.00	12.80	14	PA-14A	26.00	30.00	28.80
7	PA-7A	12.00	16.00	14.80	15	PA-15A	28.00	32.00	30.80
8	PA-8A	14.00	18.00	16.80	16	PA-16A	30.00	34.00	32.80
9	PA-9A	16.00	20.00	18.80	-	-	-	-	-

GENERAL TOLERANCES (UNLESS SPECIFIED)		ZHE JIANG DELI CONNECTORS CO ., LTD	
.X: ± 0.25	X° : ± 3.0°	PRODUCT NAME: DL20003 (PA)-A	
.XX: ± 0.15	.X° : ± 2.0°	TITLE: 2.00 mm Pitch Wire To Board Wafer	
.XXX: ± 0.01	.XX° : ± 1.0°	DR: Chen Quan Long	DATE:19/08/01
FINISH:		CHKD: Wu Hui	DATE:19/08/01
DRAWING NO:		APPD:Ren An De	DATE:19/08/01
		SCALE: N/A	PAGE: 1/1
		UNITS: mm	REV.: A

REV.	REVISION DESCRIPTION	DATE	APPD

2PIN



4-9PIN



NOTES

Available in 02 through 16 Circuits.
 Mates with DL20003-Y Series Housing.
 Material : Nylon UL94V-0(2).
 0.50mm Square Pin.
 Pin Material : Brass / Tin-Plated.

3PIN



10PIN以上



Circuits	Product name	Dimensino(mm)			Circuits	Product name	Dimensino(mm)		
		A	B	C			A	B	C
2	PA-2AS	2.00	6.00	4.80	10	PA-10AS	18.00	22.00	20.80
3	PA-3AS	4.00	8.00	6.80	11	PA-11AS	20.00	24.00	22.80
4	PA-4AS	6.00	10.00	8.80	12	PA-12AS	22.00	26.00	24.80
5	PA-5AS	8.00	12.00	10.80	13	PA-13AS	24.00	28.00	26.80
6	PA-6AS	10.00	14.00	12.80	14	PA-14AS	26.00	30.00	28.80
7	PA-7AS	12.00	16.00	14.80	15	PA-15AS	28.00	32.00	30.80
8	PA-8AS	14.00	18.00	16.80	16	PA-16AS	30.00	34.00	32.80
9	PA-9AS	16.00	20.00	18.80	-	-	-	-	-

GENERAL TOLERANCES (UNLESS SPECIFIED)		ZHE JIANG DELI CONNECTORS CO., LTD	
.X: ± 0.25	.X°: ± 3.0°	PRODUCT NAME: DL20003(PA)-AS	TITLE: 2.00 mm Pitch Wire to Board Wafer
.XX: ± 0.15	.X°: ± 2.0°	DR: Chen Quan Long	DATE:19/08/01
.XXX: ± 0.01	.XX°: ± 1.0°	CHKD: Zhang Ren Chuan	DATE:19/08/01
DRAWING NO:		APPD: Ren An De	DATE:19/08/01
FINISH:		SCALE: N/A	PAGE: 1/1
UNITS: mm		REV.: A	

REV.	7	8
	REVISION DESCRIPTION	DATE APPD

2PIN



4-9PIN



NOTES

Available in 02 through 16 Circuits.
 Mates with DL20003-Y Series Housing.
 Material : Nylon UL94V-0 (2) .
 0.50mm Square Pin.
 Pin Material : Brass / Tin-Plated.

3PIN



10PIN以上



Circuits	Product name	Dimensino (mm)			Circuits	Product name	Dimensino (mm)		
		A	B	C			A	B	C
2	PA-2AW	2.00	6.00	4.80	10	PA-10AW	18.00	22.00	20.80
3	PA-3AW	4.00	8.00	6.80	11	PA-11AW	20.00	24.00	22.80
4	PA-4AW	6.00	10.00	8.80	12	PA-12AW	22.00	26.00	24.80
5	PA-5AW	8.00	12.00	10.80	13	PA-13AW	24.00	28.00	26.80
6	PA-6AW	10.00	14.00	12.80	14	PA-14AW	26.00	30.00	28.80
7	PA-7AW	12.00	16.00	14.80	15	PA-15AW	28.00	32.00	30.80
8	PA-8AW	14.00	18.00	16.80	16	PA-16AW	30.00	34.00	32.80
9	PA-9AW	16.00	20.00	18.80	-	-	-	-	-

GENERAL TOLERANCES (UNLESS SPECIFIED)		ZHE JIANG DELI CONNECTORS CO., LTD	
.X: ± 0.25	X°: ± 3.0°	PRODUCT NAME: DL20003 (PA)-AW	TITLE: 2.00 mm Pitch Wire To Board Wafer
.XX: ± 0.15	.X°: ± 2.0°	DR: Chen Quan Long	DATE:19/08/01
.XXX: ± 0.01	.XX°: ± 1.0°	CHKD:Zhang RenChuan	DATE:19/08/01
DRAWING NO:		APPD:Ren An De	DATE:19/08/01
FINISH:		SCALE: N/A	PAGE: 1/1
		UNITS: mm	REV.: A

REV.	7	8
	REVISION DESCRIPTION	DATE APPD

2PIN



4-9PIN

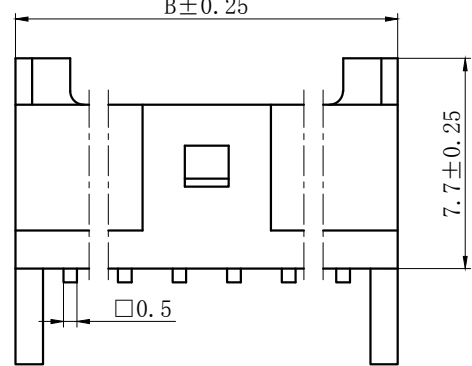

NOTES

Available in 02 through 16 Circuits.
 Mates with DL20003-Y Series Housing.
 Material : Nylon UL94V-0(2).
 0.50mm Square Pin.
 Pin Material : Brass / Tin-Plated.

3PIN

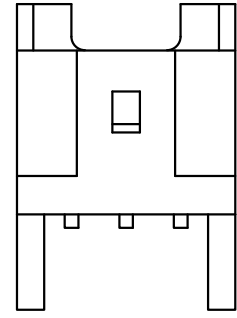

10PIN以上

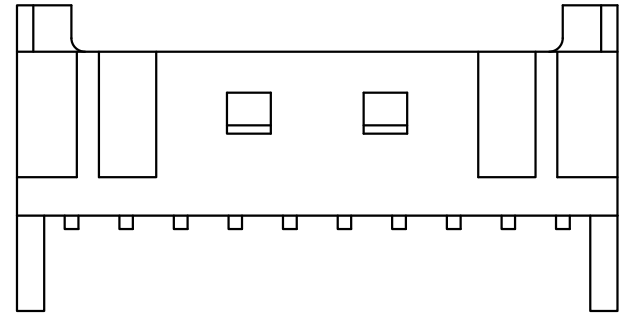

Circuits	Product name	Dimensino(mm)			Circuits	Product name	Dimensino(mm)		
		A	B	C			A	B	C
2	PA-2AWD	2.00	6.00	4.80	10	PA-10AWD	18.00	22.00	20.80
3	PA-3AWD	4.00	8.00	6.80	11	PA-11AWD	20.00	24.00	22.80
4	PA-4AWD	6.00	10.00	8.80	12	PA-12AWD	22.00	26.00	24.80
5	PA-5AWD	8.00	12.00	10.80	13	PA-13AWD	24.00	28.00	26.80
6	PA-6AWD	10.00	14.00	12.80	14	PA-14AWD	26.00	30.00	28.80
7	PA-7AWD	12.00	16.00	14.80	15	PA-15AWD	28.00	32.00	30.80
8	PA-8AWD	14.00	18.00	16.80	16	PA-16AWD	30.00	34.00	32.80
9	PA-9AWD	16.00	20.00	18.80	-	-	-	-	-

GENERAL TOLERANCES (UNLESS SPECIFIED)		ZHE JIANG DELI CONNECTORS CO., LTD			
.X: ± 0.25	X°: ± 3.0°	PRODUCT NAME: DL20003 (PA)-AWD		TITLE: 2.00 mm Pitch Wire To Board Wafer	
.XX: ± 0.15	.X°: ± 2.0°	DR: Chen Quan Long	DATE:19/08/01	PART NO:	
.XXX: ± 0.01	.XX°: ± 1.0°	CHKD: Wu Hui	DATE:19/08/01	SCALE: N/A	PAGE: 1/1
DRAWING NO:		APPD:Ren An De	DATE:19/08/01	UNITS: mm	REV.: A

REV.	7	8
REVISION DESCRIPTION	DATE	APPD

2PIN

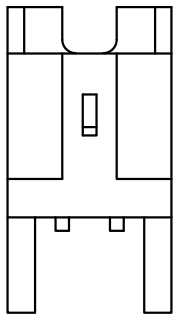

4-9PIN

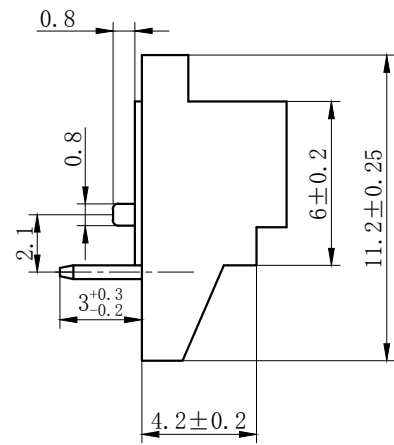
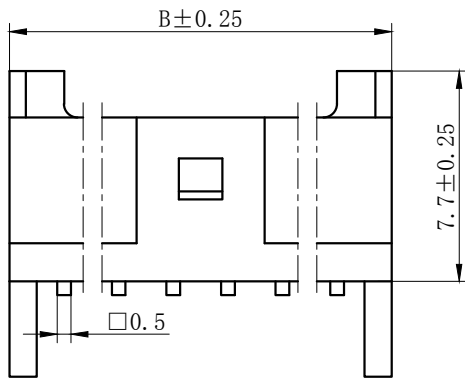

3PIN

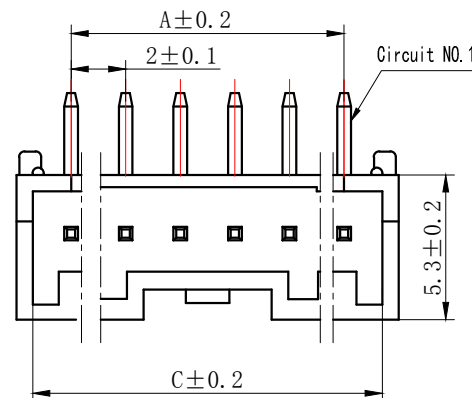
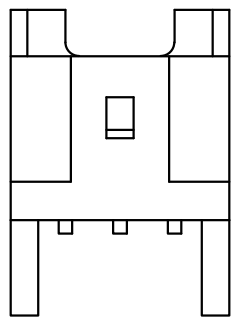

10PIN以上

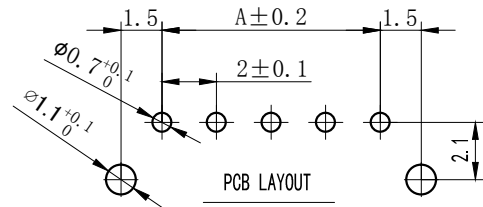
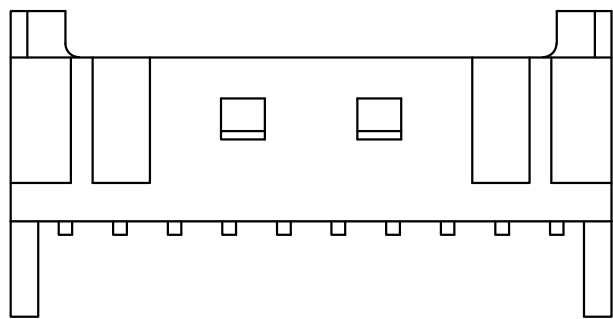

NOTES

Available in 02 through 16 Circuits.
 Mates with DL20003-Y Series Housing.
 Material : Nylon UL94V-0(2).
 0.50mm Square Pin.
 Pin Material : Brass / Tin-Plated.

Circuits	Product name	Dimensino(mm)			Circuits	Product name	Dimensino(mm)		
		A	B	C			A	B	C
2	PA-2AWD-S	2.00	6.00	4.80	10	PA-10AWD-S	18.00	22.00	20.80
3	PA-3AWD-S	4.00	8.00	6.80	11	PA-11AWD-S	20.00	24.00	22.80
4	PA-4AWD-S	6.00	10.00	8.80	12	PA-12AWD-S	22.00	26.00	24.80
5	PA-5AWD-S	8.00	12.00	10.80	13	PA-13AWD-S	24.00	28.00	26.80
6	PA-6AWD-S	10.00	14.00	12.80	14	PA-14AWD-S	26.00	30.00	28.80
7	PA-7AWD-S	12.00	16.00	14.80	15	PA-15AWD-S	28.00	32.00	30.80
8	PA-8AWD-S	14.00	18.00	16.80	16	PA-16AWD-S	30.00	34.00	32.80
9	PA-9AWD-S	16.00	20.00	18.80	-	-	-	-	-

GENERAL TOLERANCES (UNLESS SPECIFIED)		ZHE JIANG DELI CONNECTORS CO., LTD	
.X: ± 0.25	X°: ± 3.0°	PRODUCT NAME: DL20003(PA)-AWD-S	TITLE: 2.00 mm Pitch Wire To Board Wafer
.XX: ± 0.15	.X°: ± 2.0°	DR: Yuan Jun Rong	DATE:21/08/01
.XXX: ± 0.01	.XX°: ± 1.0°	CHKD: Wu Hui	DATE:21/08/01
FINISH:		APPD:Ren An De	DATE:21/08/01
DRAWING NO:			
		SCALE: N/A	PAGE: 1/1
		UNITS: mm	REV.: A

REV.	7	REVISION DESCRIPTION	8	DATE	APPD

NOTES

Available in 02 through 16 Circuits.
 Mates with DL20035-Y Series Housing.
 Material : Nylon UL94V-0 (2) .
 0.50mm Square Pin.
 Pin Material : Brass / Tin-Plated.

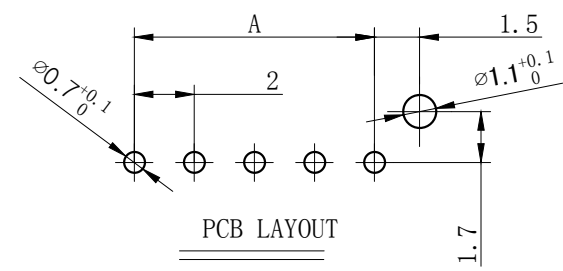
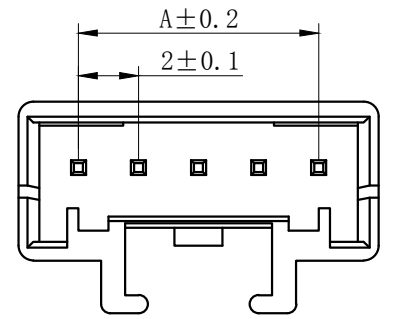

Circuits	Product name	Dimensino (mm)	
		A	B
2	PA-H-2AS	2.0	6.0
3	PA-H-3AS	4.0	8.0
4	PA-H-4AS	6.0	10.0
5	PA-H-5AS	8.0	12.0
6	PA-H-6AS	10.0	14.0
7	PA-H-7AS	12.0	16.0
8	PA-H-8AS	14.0	18.0
9	PA-H-9AS	16.0	20.0
10	PA-H-10AS	18.0	22.0
11	PA-H-11AS	20.0	24.0
12	PA-H-12AS	22.0	26.0
13	PA-H-13AS	24.0	28.0
14	PA-H-14AS	26.0	30.0
15	PA-H-15AS	28.0	32.0
16	PA-H-16AS	30.0	34.0

GENERAL TOLERANCES (UNLESS SPECIFIED)		ZHE JIANG DELI CONNECTORS CO ., LTD	
.X: ± 0.25	X° : ± 3.0°	PRODUCT NAME:	TITLE: 2.00 mm Pitch Wire To Board Wafer
.XX: ± 0.15	.X° : ± 2.0°	DL20035 (PA-H)-AS	
.XXX: ± 0.01	.XX° : ± 1.0°	DR: Zhang Wen Jing	DATE:09/08/01
FINISH:		CHKD: Wu Hui	DATE:09/08/01
DRAWING NO:		APPD:Ren An De	DATE:09/08/01
		SCALE: N/A	PAGE: 1/1
		UNITS: mm	REV.: A

REV.	REVISION DESCRIPTION	DATE	APPD

NOTES

Available in 02 through 05 Circuits.
 Mates with DL20035-Y Series Housing.
 Material : Nylon UL94V-0(2).
 Accepts DL20035-RT Crimp Terminal.

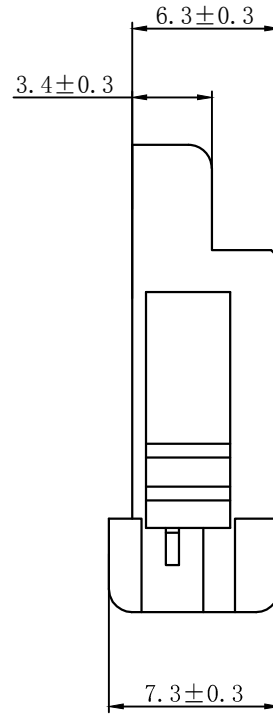

Circuits	Product name	Dimension mm				
		A	B	C	D	E
2	PA-H-2R	2.00	9.40	4.55	9.80	13.40
3	PA-H-3R	4.00	11.40	6.55	11.80	15.40
4	PA-H-4R	6.00	13.40	8.55	13.80	17.40
5	PA-H-5R	8.00	15.40	10.55	15.80	19.40

GENERAL TOLERANCES (UNLESS SPECIFIED)		ZHE JIANG DELI CONNECTORS CO., LTD			
.X: ± 0.25	X°: $\pm 3.0^\circ$	PRODUCT NAME: DL20035 (PA-H)-R		TITLE: 2.00 mm Pitch Wire To Wire Housing	
.XX: ± 0.15	.X°: $\pm 2.0^\circ$	DR: Chen Quan Long	DATE: 22/10/12	PART NO:	
.XXX: ± 0.01	.XX°: $\pm 1.0^\circ$	CHKD: Wu Hui	DATE: 22/10/12	SCALE: N/A	PAGE: 1/1
DRAWING NO:		APPD: Ren An De	DATE: 22/10/12	UNITS: mm	REV.: A

REV.	REVISION DESCRIPTION	DATE	APPD

NOTES

Available in 06 through 15 Circuits.
 Mates with DL20035-Y Series Housing.
 Material : Nylon UL94V-0(2).
 Accepts DL20035-RT Crimp Terminal.



Circuits	Product name	Dimension mm				
		A	B	C	D	E
6	PA-H-6R	10.00	17.40	12.55	19.80	21.40
7	PA-H-7R	12.00	19.40	14.55	21.80	23.40
8	PA-H-8R	14.00	21.40	16.55	23.80	25.40
9	PA-H-9R	16.00	23.40	18.55	25.80	27.40
10	PA-H-10R	18.00	25.40	20.55	27.80	29.40
11	PA-H-11R	20.00	27.40	22.55	29.80	31.40
12	PA-H-12R	22.00	29.40	24.55	31.80	33.40
13	PA-H-13R	24.00	31.40	26.55	33.80	35.40
14	PA-H-14R	26.00	33.40	28.55	35.80	37.40
15	PA-H-15R	28.00	35.40	30.55	37.80	39.40



GENERAL TOLERANCES (UNLESS SPECIFIED)		ZHE JIANG DELI CONNECTORS CO., LTD	
.X: ± 0.25	X°: $\pm 3.0^\circ$	PRODUCT NAME: DL20035 (PA-H)-R	TITLE: 2.00 mm Pitch Wire To Wire Housing
.XX: ± 0.15	.X°: $\pm 2.0^\circ$	DR: Chen Quan Long	DATE: 22/10/12
.XXX: ± 0.01	.XX°: $\pm 1.0^\circ$	CHKD: Wu Hui	DATE: 22/10/12
DRAWING NO:		APPD: Ren An De	DATE: 22/10/12
FINISH:		PART NO:	
		SCALE: N/A	PAGE: 1/1
		UNITS: mm	REV.: A

REV.	REVISION DESCRIPTION	DATE	APPD

NOTES

Available in 02 through 05 Circuits.
 Mates with DL20035-Y Series Housing.
 Material : Nylon UL94V-0(2).
 Accepts DL20035-RT Crimp Terminal.

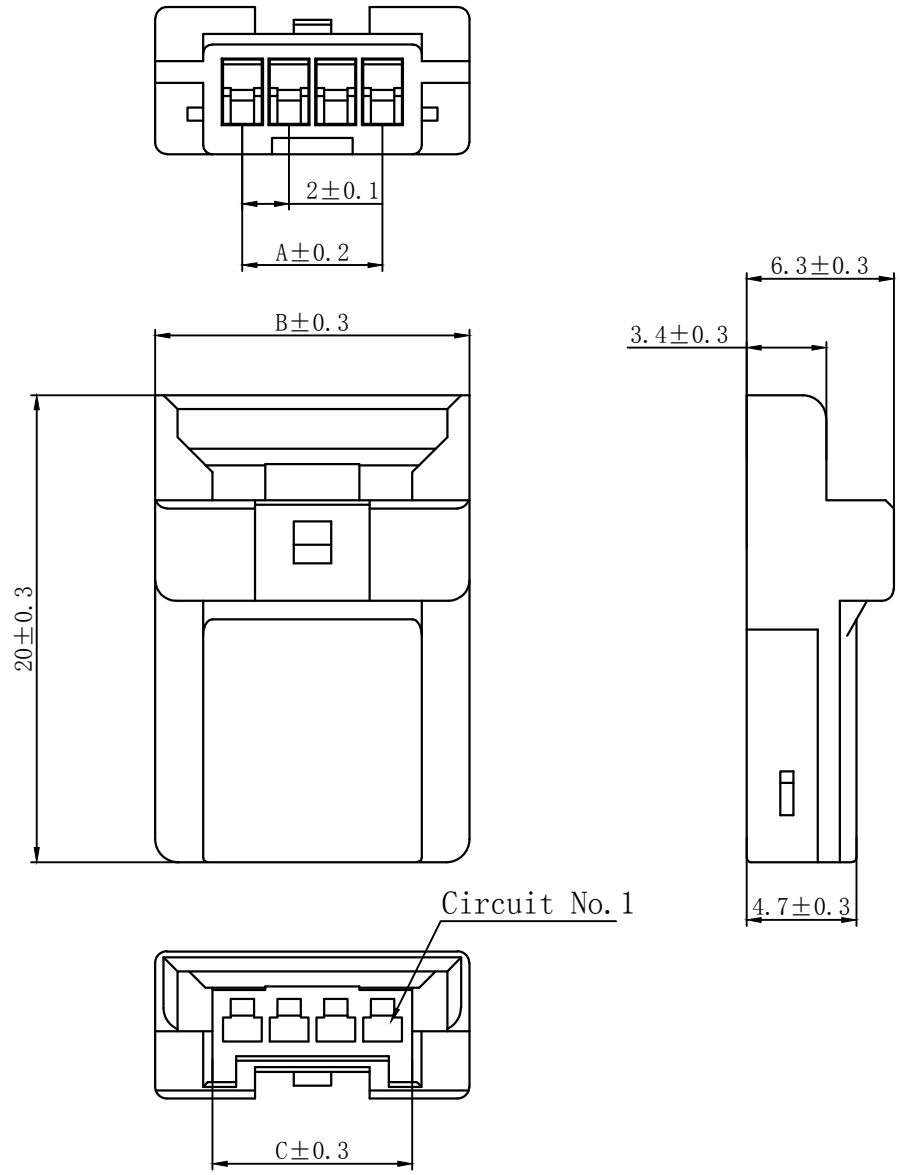

Circuits	Product name	Dimension mm		
		A	B	C
2	PA-H-2RF	2.00	9.40	4.55
3	PA-H-3RF	4.00	11.40	6.55
4	PA-H-4RF	6.00	13.40	8.55
5	PA-H-5RF	8.00	15.40	10.55

GENERAL TOLERANCES (UNLESS SPECIFIED)		ZHE JIANG DELI CONNECTORS CO., LTD	
.X: ± 0.25	X°: ± 3.0°	PRODUCT NAME: DL20035 (PA-H)-RF	TITLE: 2.00 mm Pitch Wire To Wire Housing
.XX: ± 0.15	.X°: ± 2.0°	DR: Chen Quan Long	DATE: 22/10/12
.XXX: ± 0.01	.XX°: ± 1.0°	CHKD: Wu Hui	DATE: 22/10/12
FINISH: _____		APPD: Ren An De	DATE: 22/10/12
DRAWING NO:			PART NO:
			SCALE: N/A
			PAGE: 1/1
			UNITS: mm
			REV.: A

REV.	REVISION DESCRIPTION	DATE	APPD

NOTES

Available in 06 through 15 Circuits.
 Mates with DL20035-Y Series Housing.
 Material : Nylon UL94V-0(2).
 Accepts DL20035-RT Crimp Terminal.



Circuits	Product name	Dimension mm		
		A	B	C
6	PA-H-6RF	10.00	17.40	12.55
7	PA-H-7RF	12.00	19.40	14.55
8	PA-H-8RF	14.00	21.40	16.55
9	PA-H-9RF	16.00	23.40	18.55
10	PA-H-10RF	18.00	25.40	20.55
11	PA-H-11RF	20.00	27.40	22.55
12	PA-H-12RF	22.00	29.40	24.55
13	PA-H-13RF	24.00	31.40	26.55
14	PA-H-14RF	26.00	33.40	28.55
15	PA-H-15RF	28.00	35.40	30.55

GENERAL TOLERANCES (UNLESS SPECIFIED)		ZHE JIANG DELI CONNECTORS CO., LTD	
.X: ± 0.25	X°: ± 3.0°	PRODUCT NAME: DL20035 (PA-H)-RF	TITLE: 2.00 mm Pitch Wire To Wire Housing
.XX: ± 0.15	.X°: ± 2.0°	DR: Chen Quan Long	DATE:22/10/12
.XXX: ± 0.01	.XX°: ± 1.0°	CHKD: Wu Hui	DATE:22/10/12
FINISH:		APPD: Ren An De	DATE:22/10/12
DRAWING NO:			

A
B
C
D
E
F

A
B
C
D
E
F

1 2 3 4 5 6 7 8

1 2 3 4 5 6 7 8

REV.	7	8
REVISION DESCRIPTION	DATE	APPD

A
B
C
D
E
F

A
B
C
D
E
F

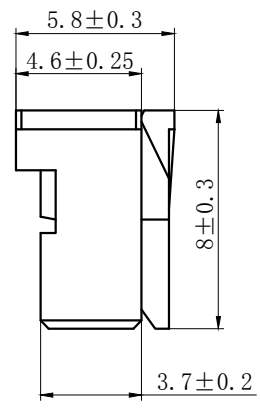

NOTES

Available in 02 through 16 Circuits.
Match with DL20003 series housing.
Material : Nylon UL94V-0 (2) .
Accepts DL20003-T Crimp Terminal.

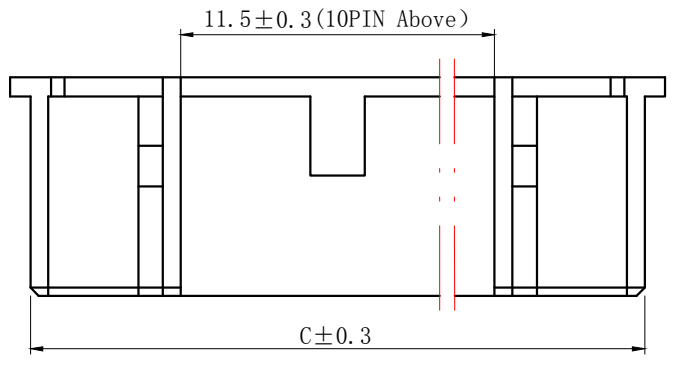
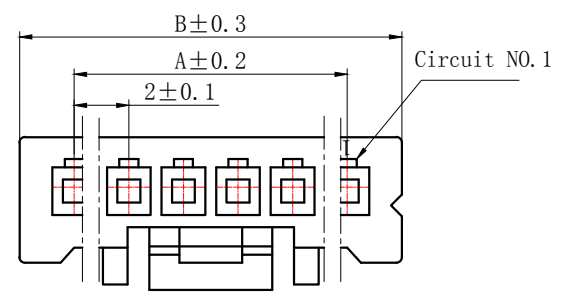
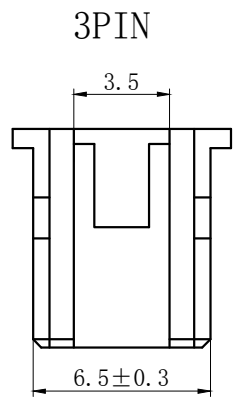

Circuits	PRODUCT NAME	Dimension mm			Circuits	PRODUCT NAME	Dimension mm		
		A	B	C			A	B	C
2	PA-2Y	2.0	6.0	4.5	10	PA-10Y	18.0	22.0	20.5
3	PA-3Y	4.0	8.0	6.5	11	PA-11Y	20.0	24.0	22.5
4	PA-4Y	6.0	10.0	8.5	12	PA-12Y	22.0	26.0	24.5
5	PA-5Y	8.0	12.0	10.5	13	PA-13Y	24.0	28.0	26.5
6	PA-6Y	10.0	14.0	12.5	14	PA-14Y	26.0	30.0	28.5
7	PA-7Y	12.0	16.0	14.5	15	PA-15Y	28.0	32.0	30.5
8	PA-8Y	14.0	18.0	16.5	16	PA-16Y	30.0	34.0	32.5
9	PA-9Y	16.0	20.0	18.5					

GENERAL TOLERANCES (UNLESS SPECIFIED)		ZHE JIANG DELI CONNECTORS CO ., LTD			
.X: ± 0.25	X° : ± 3.0°	PRODUCT NAME: DL20003 (PA)-Y		TITLE: 2.00 mm Pitch Housing	
.XX: ± 0.15	.X° : ± 2.0°	DR: Chen Quan Long	DATE:19/08/01	PART NO:	
.XXX: ± 0.01	.XX° : ± 1.0°	CHKD:Wu Hui	DATE:19/08/01	SCALE: N/A	PAGE: 1/1
DRAWING NO:		APPD:Ren An De	DATE:19/08/01	UNITS: mm	REV.: A

1 2 3 4 5 6 7 8

REV.	REVISION DESCRIPTION	DATE	APPD

NOTES

Available in 02 through 16 Circuits.
 Match with DL20035-AS series Wafer.
 Material : Nylon UL94V-0 (2) .
 Accepts DL20035-T Crimp Terminal.

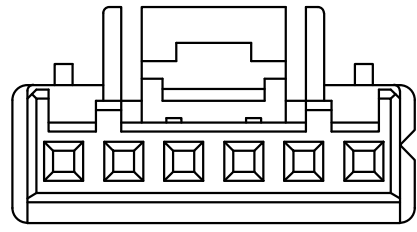

A

B

C

D

E

F

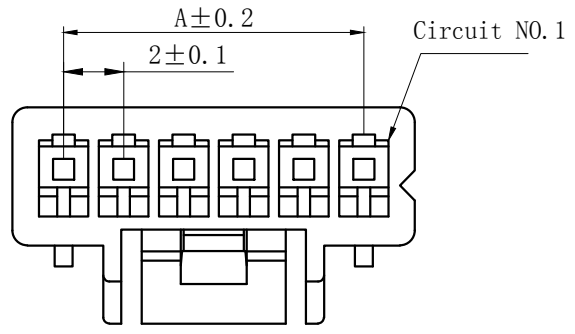
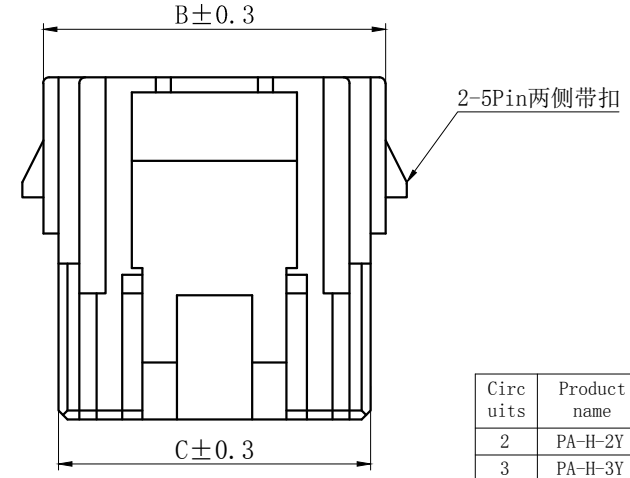
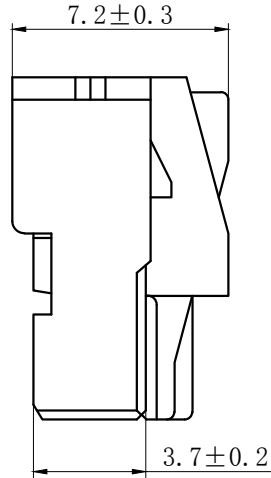
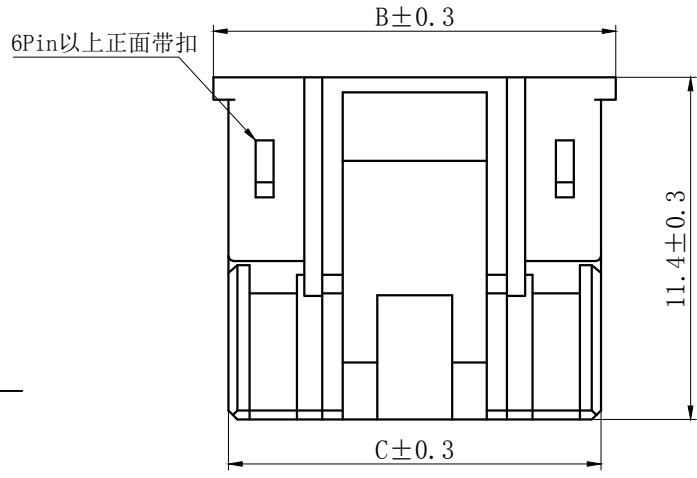

Circuits	Product name	Dimensino (mm)		
		A	B	C
2	PA-H-2Y	2.0	5.4	4.5
3	PA-H-3Y	4.0	7.4	6.5
4	PA-H-4Y	6.0	9.4	8.5
5	PA-H-5Y	8.0	11.4	10.5
6	PA-H-6Y	10.0	13.4	12.5
7	PA-H-7Y	12.0	15.4	14.5
8	PA-H-8Y	14.0	17.4	16.5
9	PA-H-9Y	16.0	19.4	18.5
10	PA-H-10Y	18.0	21.4	20.5
11	PA-H-11Y	20.0	23.4	22.5
12	PA-H-12Y	22.0	25.4	24.5
13	PA-H-13Y	24.0	27.4	26.5
14	PA-H-14Y	26.0	29.4	28.5
15	PA-H-15Y	28.0	31.4	30.5
16	PA-H-16Y	30.0	33.4	32.5

GENERAL TOLERANCES (UNLESS SPECIFIED)		ZHE JIANG DELI CONNECTORS CO., LTD	
.X: ± 0.25	X° : ± 3.0°	PRODUCT NAME:	TITLE:
.XX: ± 0.15	.X° : ± 2.0°	DL20035 (PA-H)-Y	2.00 mm Pitch Housing
.XXX: ± 0.01	.XX° : ± 1.0°	DR: Chen Quan Long	DATE:22/08/01
FINISH:		CHKD:Wu Hui	DATE:22/08/01
DRAWING NO:		APPD:Ren An De	DATE:22/08/01
			PART NO:
			SCALE: N/A
			PAGE: 1/1
			UNITS: mm
			REV.: A

1 2 3 4 5 6 7 8

1 2 3 4 5 6 7 8

REV.	REVISION DESCRIPTION	DATE	APPD

NOTES

Available in 02 through 05 Circuits.
 Mates with DL20035-Y Series Housing.
 Material : Nylon UL94V-0(2).
 Green Material RoHS Compliant.



Circuits	Product name	Dimensino (mm)	
		A	B
2	PA-H-2S	2.0	7.3
3	PA-H-3S	4.0	9.3
4	PA-H-4S	6.0	11.3
5	PA-H-5S	8.0	13.3

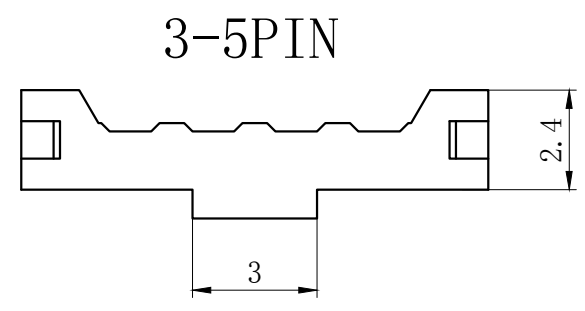
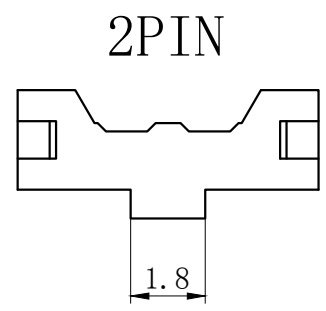

GENERAL TOLERANCES (UNLESS SPECIFIED)		ZHE JIANG DELI CONNECTORS CO., LTD	
.X: ± 0.25	X°: ± 3.0°	PRODUCT NAME: DL20035 (PA-H)-S	TITLE: 2.0 mm Pitch Wire To Board
.XX: ± 0.15	.X°: ± 2.0°	DR: Chen Quan Long	DATE:19/08/01
.XXX: ± 0.01	.XX°: ± 1.0°	CHKD: Wu Hui	DATE:19/08/01
FINISH:		APPD:Ren An De	DATE:19/08/01
DRAWING NO:			

A

B

C

D

E

F

A

B

C

D

E

F

1 2 3 4 5 6 7 8

1 2 3 4 5 6 7 8

REV.	REVISION DESCRIPTION	DATE	APPD

NOTES

Available in 06 through 16 Circuits.
 Mates with DL20035-Y Series Housing.
 Material : Nylon UL94V-0(2).
 Green Material RoHS Compliant.

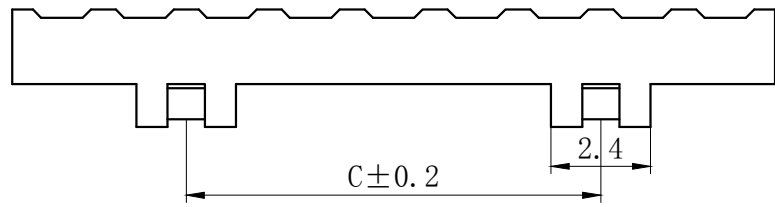
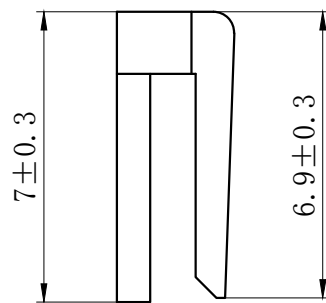
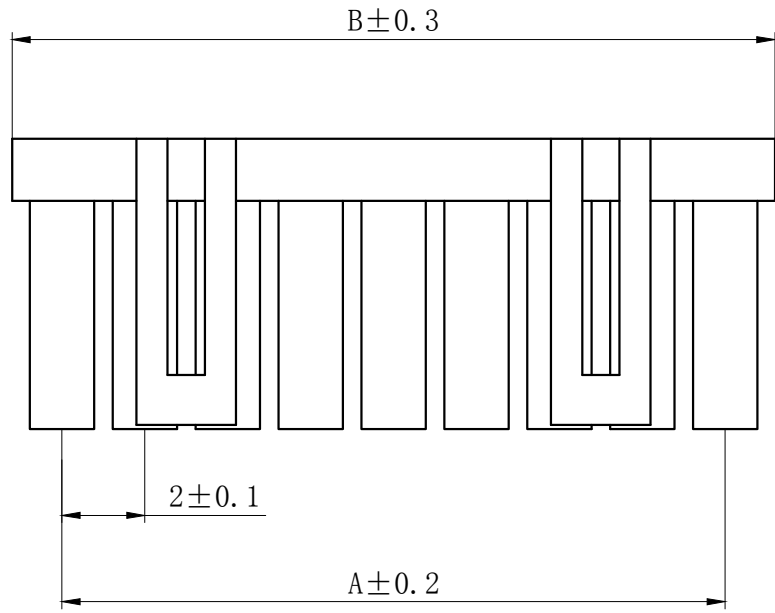
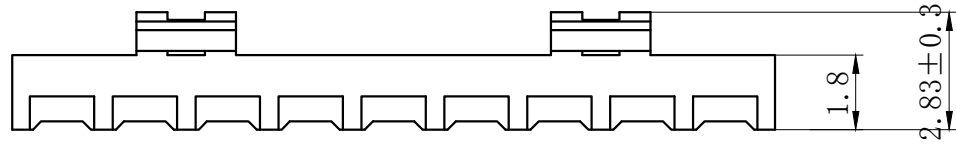

Circuits	Product name	Dimensino(mm)		
		A	B	C
6	PA-H-6S	10.0	12.4	10.0
7	PA-H-7S	12.0	14.4	10.0
8	PA-H-8S	14.0	16.4	10.0
9	PA-H-9S	16.0	18.4	10.0
10	PA-H-10S	18.0	20.4	17.4
11	PA-H-11S	20.0	22.4	17.4
12	PA-H-12S	22.0	24.4	17.4
13	PA-H-13S	24.0	26.4	17.4
14	PA-H-14S	26.0	28.4	17.4
15	PA-H-15S	28.0	30.4	17.4
16	PA-H-16S	30.0	32.4	17.4

GENERAL TOLERANCES (UNLESS SPECIFIED)		ZHE JIANG DELI CONNECTORS CO., LTD	
.X: ± 0.25	X°: ± 3.0°	PRODUCT NAME: DL20035 (PA-H)-S	TITLE: 2.0 mm Pitch Wire To Board
.XX: ± 0.15	.X°: ± 2.0°	DR: Chen Quan Long	DATE:19/08/01
.XXX: ± 0.01	.XX°: ± 1.0°	CHKD: Wu Hui	DATE:19/08/01
FINISH:		APPD:Ren An De	DATE:19/08/01
DRAWING NO:			
			PART NO:
			SCALE: N/A
			PAGE: 2/2
			UNITS: mm
			REV.: A

REV.	REVISION DESCRIPTION	DATE	APPD



NOTES

Used in DL20003-Y Series Housing.
 Accepts AWG #28~22 Wire Range.
 0.08~ 0.33 mm² .
 Insulation O.D.=0.9~1.5 mm.
 Material : Phosphor Bronze .
 Finish: Tin plated.
 Thickness: 0.2 mm.



SECTION A-A



SECTION B-B



SECTION C-C

GENERAL TOLERANCES (UNLESS SPECIFIED)		ZHE JIANG DELI CONNECTORS CO., LTD	
.X: ± 0.25	X°: ± 3.0°	PRODUCT NAME: DL20003 (PA)-T	TITLE: 2.00 mm Pitch Crimp Terminal
.XX: ± 0.15	.X°: ± 2.0°	DR:Chen Quan Long	DATE:20.3.31
.XXX: ± 0.01	.XX°: ± 1.0°	CHKD:Wu Hui	DATE:20.3.31
DRAWING NO:		APPD:Ren An De	DATE:20.3.31
FINISH:		SCALE: N/A	PAGE: 1/1
PART NO:		UNITS: mm	REV.: A

REV.	REVISION DESCRIPTION	DATE	APPD



NOTES

Used in DL20035-Y Series Housing.
 Accepts AWG #26~22 Wire Range.
 0.13~ 0.33 mm² .
 Insulation O.D.=0.9~1.5 mm.
 Material : Phosphor Bronze .
 Finish: Tin plated.
 Thickness: 0.2 mm.

GENERAL TOLERANCES (UNLESS SPECIFIED)		ZHE JIANG DELI CONNECTORS CO., LTD	
.X: ± 0.25	X° : ± 3.0°	PRODUCT NAME: DL20035 (PA-H)-T	TITLE: 2.00 mm Pitch Crimp Terminal
.XX: ± 0.15	.X° : ± 2.0°	DR:Chen Quan Long	DATE:22.3.31
.XXX: ± 0.01	.XX° : ± 1.0°	CHKD:Wu Hui	DATE:22.3.31
DRAWING NO:		APPD:Ren An De	DATE:22.3.31
FINISH:		SCALE: N/A	PAGE: 1/1
PART NO:		UNITS: mm	REV.: A

REV.	REVISION DESCRIPTION	DATE	APPD

A
B
C
D
E
F

A
B
C
D
E
F

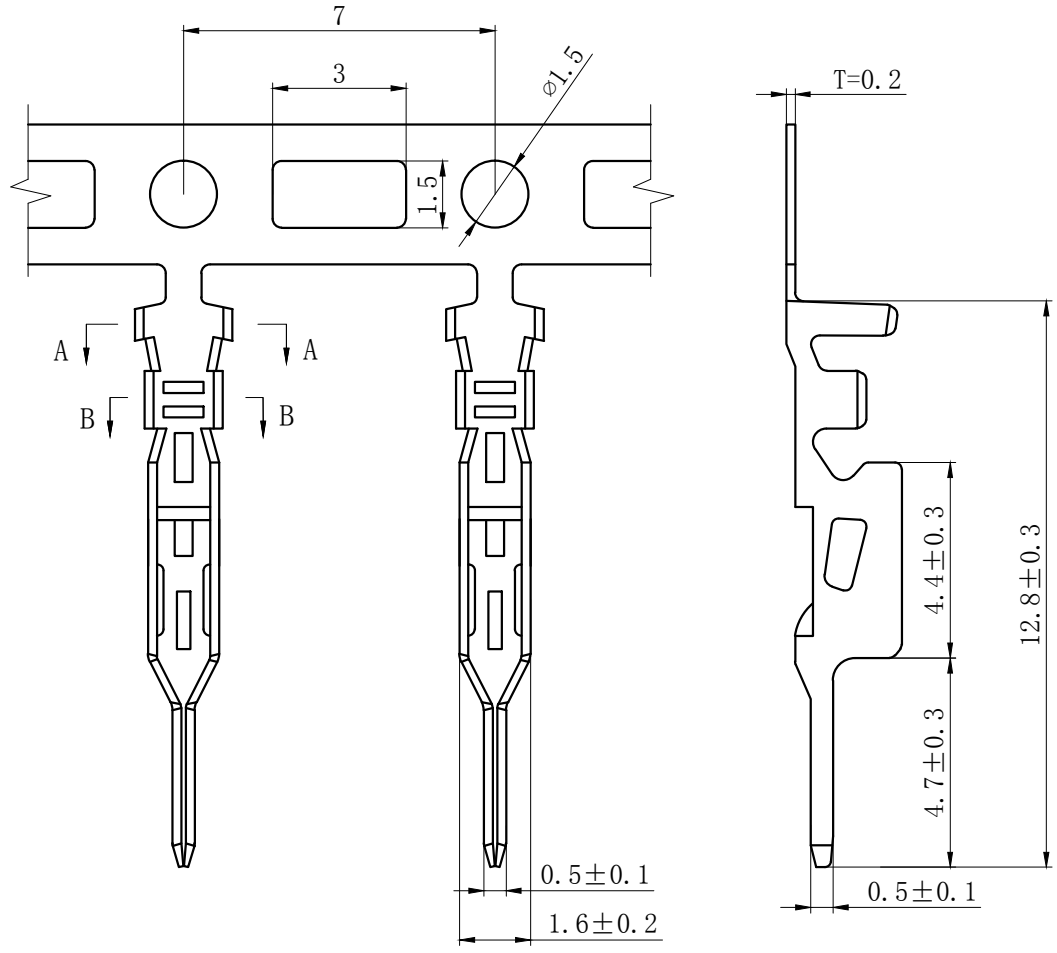

技术特性/Specifications:
 额定电压Rated voltage :250V AC.DC.
 额定电流Rated current :3A AC.DC.
 接触电阻Contact resistance:20MΩ MAX
 绝缘电阻Insulation resistance: 1000 MΩ MIN
 耐压Withstand voltage:800V AC/minute
 环境温度Ambient temperature: -40℃~+105℃
 材料/Materials:
 端子Terminal: 磷青铜Phosphor bronze ,
 镀锡Tin plated

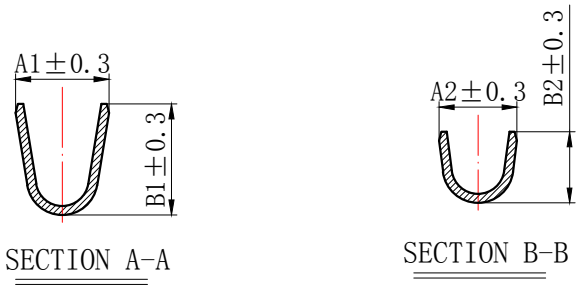

TYPE	Dimension mm				适用线规 AWG#
	A1	B1	A2	B2	
PA-H-RT	2.1	2.5	1.75	1.6	26-22
PA-H-RT-D	2.1	2.5	1.75	1.4	28-24

GENERAL TOLERANCES (UNLESS SPECIFIED)		ZHE JIANG DELI CONNECTORS CO., LTD			
.X: ± 0.25	X°: ± 3.0°	PRODUCT NAME: DL25035 (PA-H)-RT		TITLE: 2.00 mm Pitch Wire To Wire Terminal	
.XX: ± 0.15	.X°: ± 2.0°	DR:Yuan Jun Rong		DATE:21/12/30	
.XXX: ± 0.01	.XX°: ± 1.0°	CHKD:Wu Hui		DATE:21/12/30	
DRAWING NO:		APPD:Ren An De		DATE:21/12/30	
				SCALE: N/A	PAGE: 1/1
				UNITS: mm	REV.: A

1 2 3 4 5 6 7 8

X-ON Electronics

Largest Supplier of Electrical and Electronic Components

Click to view similar products for [Headers & Wire Housings](#) category:

Click to view products by [DLL](#) manufacturer:

Other Similar products are found below :

[0015917161](#) [0022155065](#) [57102-F02-18ULF](#) [58102-G61-06LF](#) [582553-1](#) [01.001.5753.1](#) [0050291907](#) [02.125.8002.8](#) [609-3404](#) [61062-3](#)
[CSU011177004](#) [622-0430](#) [622-3653LF](#) [63453-116](#) [636-1030](#) [636-1427](#) [636-3427](#) [636-4007](#) [641938-9](#) [65495-038](#) [65692-001LF](#) [65781-018](#)
[65781-047](#) [65817-010LF](#) [65817-015LF](#) [67095-007LF](#) [67601157](#) [68631-112](#) [68645-018](#) [699319-000](#) [70.362.1628.0](#) [70-4210](#) [70-4226B](#) [70-](#)
[4853B](#) [71.350.2428.0](#) [733-134](#) [733-162](#) [760-3052](#) [MHR-64-VUAL](#) [80.063.4001.1](#) [800-90-001-10-001000](#) [801-43-002-10-013000](#)
[801-43-006-10-002000](#) [803-43-024-10-001000](#) [803-93-012-10-001000](#) [8-1437020-4](#) [819-22-004-30-001101](#) [820-22-006-30-001101](#)
[820-22-008-30-001101](#) [821-22-002-10-001101](#)