

## 技术特性/Specifications:

额定电压 Rated voltage: 250V AC, DC  
额定电流 Rated current: 3A AC, DC  
接触电阻 Contact resistance: 20m $\Omega$  max  
绝缘电阻 Insulation resistance: 1000M $\Omega$  min  
耐压 Withstand voltage: 800V AC/minute  
环境温度 Ambient temperature: -40 $^{\circ}$ C~+105 $^{\circ}$ C  
适用线规 Wire range: AWG#28~#22

| REV. | REVISION DESCRIPTION | DATE |
|------|----------------------|------|
|      |                      |      |

技术特性/Specifications:

额定电流 Rated current: 3A AC\DC  
 额定电压 Rated voltage: 250V AC\DC  
 接触电阻 Contact resistance: 20mΩ max  
 绝缘电阻 Insulation resistance: 1000MΩ min  
 耐压 Withstand voltage: 800V AC/ minute  
 环境温度 Ambient temperature: -40℃ to 105℃  
 材料/Materials:  
 针座Wafer: LCP UL94V-0  
 铜针Pin Material: 黄铜Brass / Tin-Plated.

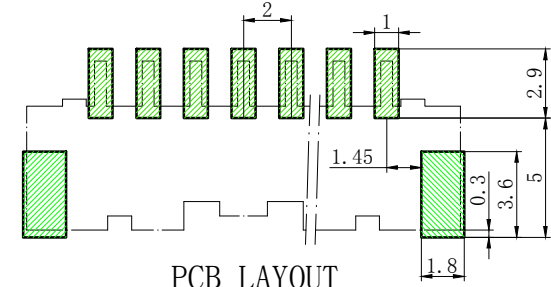
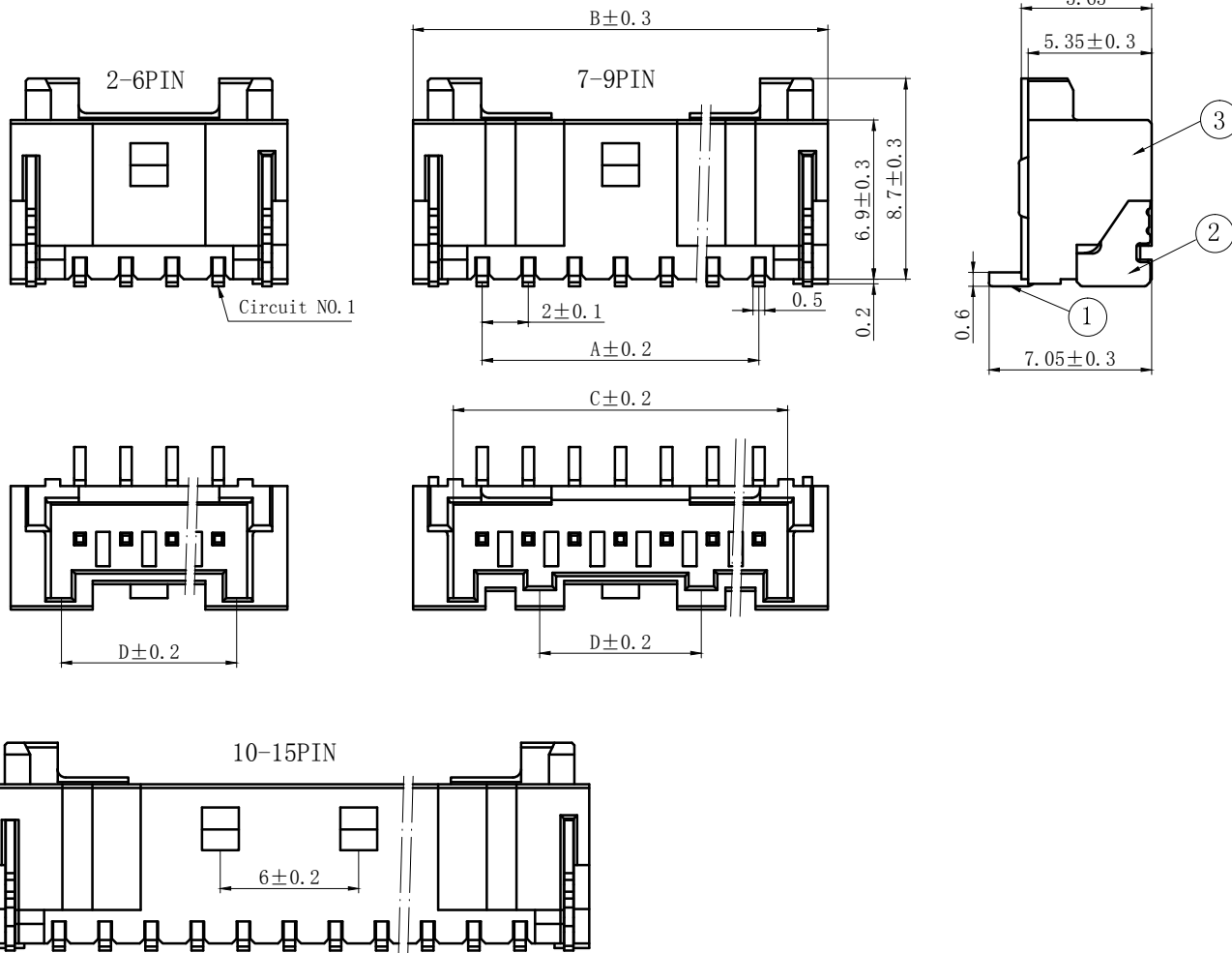

|    |    |     |     |    |         |
|----|----|-----|-----|----|---------|
| 3  | ③  | 基座  | LCP | 1  | UL94V-0 |
| 2  | ②  | 焊片  | 黄铜  | 2  | 镀锡      |
| 1  | ①  | 接触件 | 黄铜  | N* | 镀锡      |
| 序号 | 图号 | 名称  | 材料  | 数量 | 附件      |

| Circ uits | Product name | Dimension mm |       |       |      | Circ uits | Product name | Dimension mm |       |       |       |
|-----------|--------------|--------------|-------|-------|------|-----------|--------------|--------------|-------|-------|-------|
|           |              | A            | B     | C     | D    |           |              | A            | B     | C     | D     |
| 2         | PA-2AB       | 2.00         | 8.00  | 4.50  | 3.60 | 10        | PA-10AB      | 18.00        | 24.00 | 20.50 | 13.60 |
| 3         | PA-3AB       | 4.00         | 10.00 | 6.50  | 5.60 | 11        | PA-11AB      | 20.00        | 26.00 | 22.50 | 13.60 |
| 4         | PA-4AB       | 6.00         | 12.00 | 8.50  | 7.60 | 12        | PA-12AB      | 22.00        | 28.00 | 24.50 | 13.60 |
| 5         | PA-5AB       | 8.00         | 14.00 | 10.50 | 7.00 | 13        | PA-13AB      | 24.00        | 30.00 | 26.50 | 13.60 |
| 6         | PA-6AB       | 10.00        | 16.00 | 12.50 | 7.00 | 14        | PA-14AB      | 26.00        | 32.00 | 28.50 | 13.60 |
| 7         | PA-7AB       | 12.00        | 18.00 | 14.50 | 7.00 | 15        | PA-15AB      | 28.00        | 34.00 | 30.50 | 13.60 |
| 8         | PA-8AB       | 14.00        | 20.00 | 16.50 | 7.00 | 16        | PA-16AB      | 30.00        | 36.00 | 32.50 | 13.60 |
| 9         | PA-9AB       | 16.00        | 22.00 | 18.50 | 7.00 | -         | -            | -            | -     | -     | -     |

| GENERAL TOLERANCES (UNLESS SPECIFIED) |              |                                  |                | ZHE JIANG DELI CONNECTORS CO.,LTD                  |           |  |  |
|---------------------------------------|--------------|----------------------------------|----------------|--|-----------|--|--|
| .X: ± 0.25                            | X°: ± 3.0°   | PRODUCT NAME:<br>DL20003 (PA)-AB |                | TITLE:<br>2.00 mm Pitch<br>Wire To Board SMT Wafer |           |  |  |
| .XX: ± 0.15                           | .X°: ± 2.0°  | DR: Chen Quan Long               | DATE: 19/04/03 | PART NO:   |           |  |  |
| .XXX: ± 0.01                          | .XX°: ± 1.0° | CHKD: Wu Hui                     | DATE: 19/04/03 | SCALE: N/A   | PAGE: 1/1 |  |  |
| FINISH:                               |              | APPD: Ren An De                  | DATE: 19/04/03 | UNITS: mm  | REV.: A   |  |  |
| DRAWING NO:                           |              |                                  |                |  |           |  |  |

| REV. | REVISION DESCRIPTION | DATE |
|------|----------------------|------|
|      |                      |      |

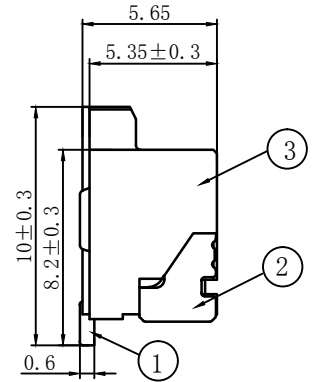
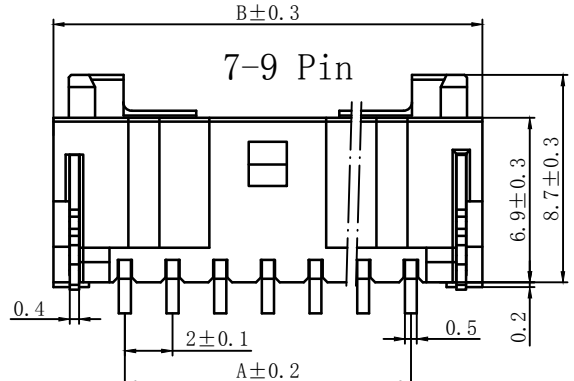
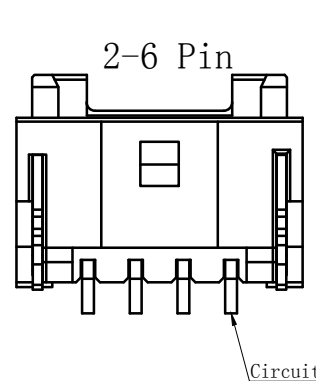

技术特性/Specifications:  
 额定电流 Rated current: 3A AC\DC  
 额定电压 Rated voltage: 250V AC\DC  
 接触电阻 Contact resistance: 20mΩ max  
 绝缘电阻 Insulation resistance: 1000MΩ min  
 耐压 Withstand voltage: 800V AC/ minute  
 环境温度 Ambient temperature: -40℃ to 105℃  
 材料/Materials:  
 针座Wafer: LCP UL94V-0  
 铜针Pin Material : 黄铜Brass / Tin-Plated.

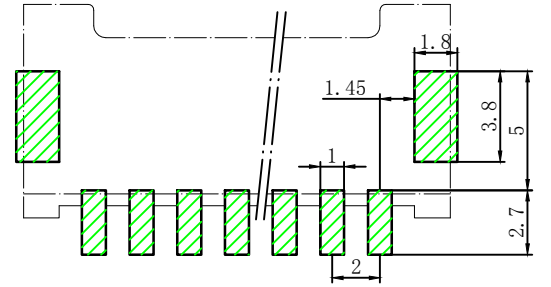
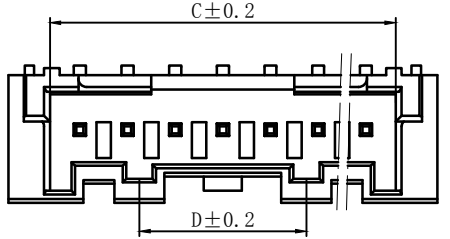
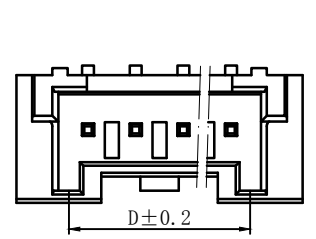

PCB LAYOUT

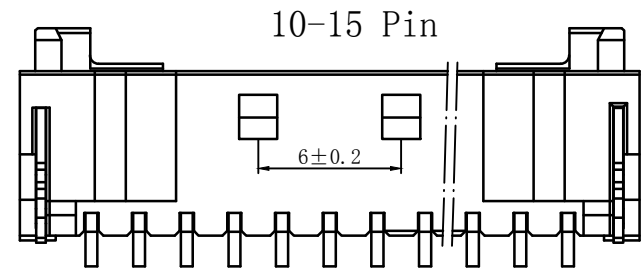

|    |    |     |     |    |         |
|----|----|-----|-----|----|---------|
| 3  | ③  | 基座  | LCP | 1  | UL94V-0 |
| 2  | ②  | 焊片  | 黄铜  | 2  | 镀锡      |
| 1  | ①  | 接触件 | 黄铜  | N* | 镀锡      |
| 序号 | 图号 | 名称  | 材料  | 数量 | 附件      |

| Circuits | Product name | Dimension mm |       |       |      | Circuits | Product name | Dimension mm |       |       |       |
|----------|--------------|--------------|-------|-------|------|----------|--------------|--------------|-------|-------|-------|
|          |              | A            | B     | C     | D    |          |              | A            | B     | C     | D     |
| 2        | PA-2AWB      | 2.00         | 8.00  | 4.50  | 3.60 | 10       | PA-10AWB     | 18.00        | 24.00 | 20.50 | 13.60 |
| 3        | PA-3AWB      | 4.00         | 10.00 | 6.50  | 5.60 | 11       | PA-11AWB     | 20.00        | 26.00 | 22.50 | 13.60 |
| 4        | PA-4AWB      | 6.00         | 12.00 | 8.50  | 7.60 | 12       | PA-12AWB     | 22.00        | 28.00 | 24.50 | 13.60 |
| 5        | PA-5AWB      | 8.00         | 14.00 | 10.50 | 7.00 | 13       | PA-13AWB     | 24.00        | 30.00 | 26.50 | 13.60 |
| 6        | PA-6AWB      | 10.00        | 16.00 | 12.50 | 7.00 | 14       | PA-14AWB     | 26.00        | 32.00 | 28.50 | 13.60 |
| 7        | PA-7AWB      | 12.00        | 18.00 | 14.50 | 7.00 | 15       | PA-15AWB     | 28.00        | 34.00 | 30.50 | 13.60 |
| 8        | PA-8AWB      | 14.00        | 20.00 | 16.50 | 7.00 | 16       | PA-16AWB     | 30.00        | 36.00 | 32.50 | 13.60 |
| 9        | PA-9AWB      | 16.00        | 22.00 | 18.50 | 7.00 | -        | -            | -            | -     | -     | -     |

GENERAL TOLERANCES (UNLESS SPECIFIED)

|              |               |  |  |
|--------------|---------------|--|--|
| .X: ± 0.25   | X° : ± 3.0°   | PRODUCT NAME:<br><b>DL20003 (PA)-AWB</b> | TITLE:<br>2.00 mm Pitch<br>Wire To Board SMT Wafer |
| .XX: ± 0.15  | .X° : ± 2.0°  | DR: Chen Quan Long                       | DATE: 19/04/03                                     |
| .XXX: ± 0.01 | .XX° : ± 1.0° | CHKD: Wu Hui                             | DATE: 19/04/03                                     |
| FINISH:      |               | APPD: Ren An De                          | DATE: 19/04/03                                     |
| DRAWING NO:  |               | UNITS: mm                                | REV.: A  |

ZHE JIANG DELI CONNECTORS CO., LTD

SCALE: N/A PAGE: 1/1

UNITS: mm REV.: A

| REV. | REVISION DESCRIPTION | DATE | APPD |
|------|----------------------|------|------|
|      |                      |      |      |

### NOTES

Available in 02 through 16 Circuits.  
 Mates with DL20003-Y Series Housing.  
 Material : Nylon UL94V-0 (2) .  
 0.50mm Square Pin.  
 Pin Material : Brass / Tin-Plated.

2PIN

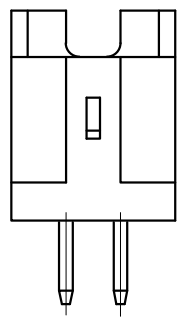

4-9PIN

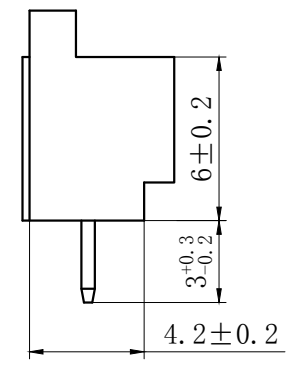
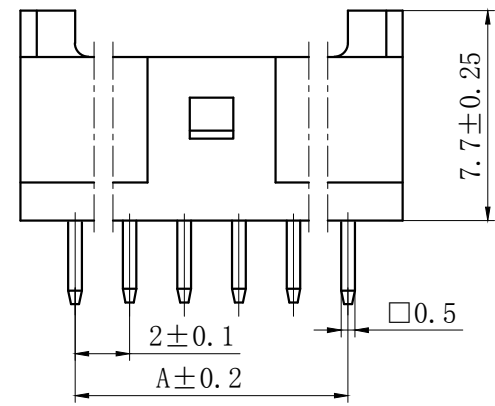

3PIN

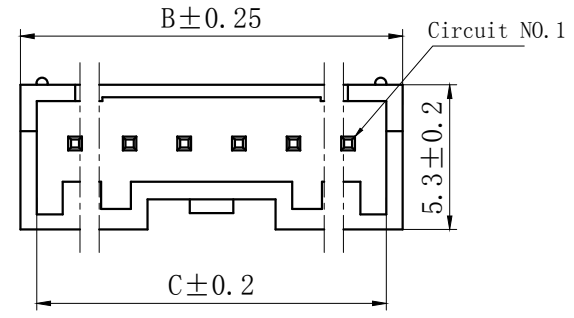
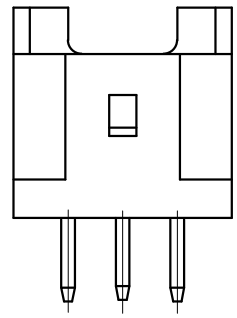

10PIN以上

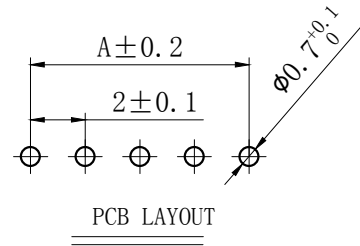
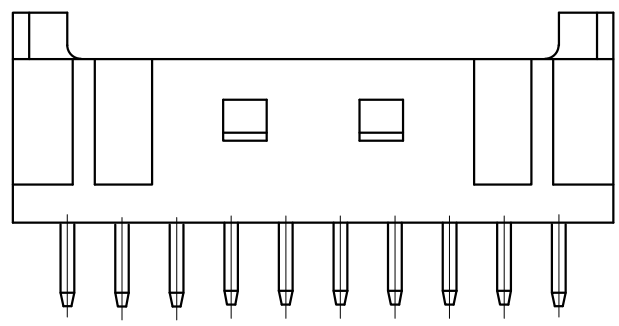

| Circuits | Product name | Dimensino (mm) |       |       | Circuits | Product name | Dimensino (mm) |       |       |
|----------|--------------|----------------|-------|-------|----------|--------------|----------------|-------|-------|
|          |              | A              | B     | C     |          |              | A              | B     | C     |
| 2        | PA-2A        | 2.00           | 6.00  | 4.80  | 10       | PA-10A       | 18.00          | 22.00 | 20.80 |
| 3        | PA-3A        | 4.00           | 8.00  | 6.80  | 11       | PA-11A       | 20.00          | 24.00 | 22.80 |
| 4        | PA-4A        | 6.00           | 10.00 | 8.80  | 12       | PA-12A       | 22.00          | 26.00 | 24.80 |
| 5        | PA-5A        | 8.00           | 12.00 | 10.80 | 13       | PA-13A       | 24.00          | 28.00 | 26.80 |
| 6        | PA-6A        | 10.00          | 14.00 | 12.80 | 14       | PA-14A       | 26.00          | 30.00 | 28.80 |
| 7        | PA-7A        | 12.00          | 16.00 | 14.80 | 15       | PA-15A       | 28.00          | 32.00 | 30.80 |
| 8        | PA-8A        | 14.00          | 18.00 | 16.80 | 16       | PA-16A       | 30.00          | 34.00 | 32.80 |
| 9        | PA-9A        | 16.00          | 20.00 | 18.80 | -        | -            | -              | -     | -     |

| GENERAL TOLERANCES (UNLESS SPECIFIED) |               | ZHE JIANG DELI CONNECTORS CO ., LTD |                      |
|---------------------------------------|---------------|-------------------------------------|----------------------|
| .X: ± 0.25                            | X° : ± 3.0°   | PRODUCT NAME:                       | TITLE: 2.00 mm Pitch |
| .XX: ± 0.15                           | .X° : ± 2.0°  | DL20003 (PA)-A                      | Wire To Board Wafer  |
| .XXX: ± 0.01                          | .XX° : ± 1.0° | DR: Chen Quan Long                  | DATE:19/08/01        |
| FINISH:                               |               | CHKD: Wu Hui                        | DATE:19/08/01        |
| DRAWING NO:                           |               | APPD:Ren An De                      | DATE:19/08/01        |
|                                       |               | SCALE: N/A                          | PAGE: 1/1            |
|                                       |               | UNITS: mm                           | REV.: A              |

| REV. | REVISION DESCRIPTION | DATE | APPD |
|------|----------------------|------|------|
|      |                      |      |      |

2PIN

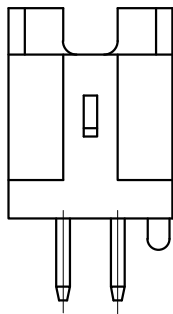

4-9PIN

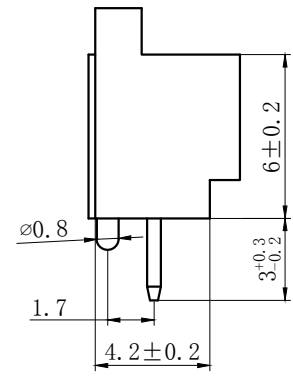
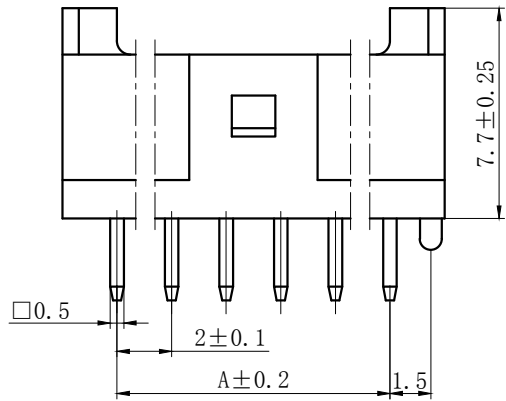

NOTES

Available in 02 through 16 Circuits.  
 Mates with DL20003-Y Series Housing.  
 Material : Nylon UL94V-0(2).  
 0.50mm Square Pin.  
 Pin Material : Brass / Tin-Plated.

3PIN

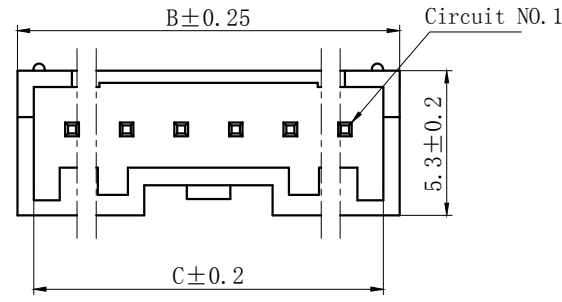
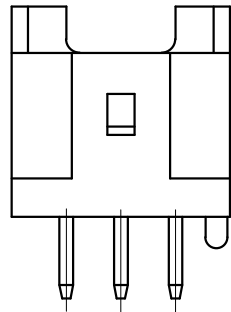

10PIN以上

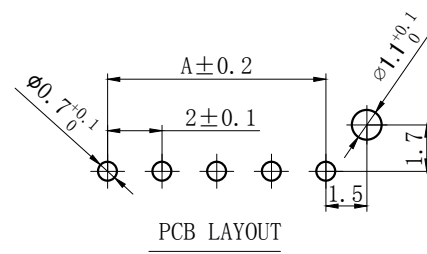
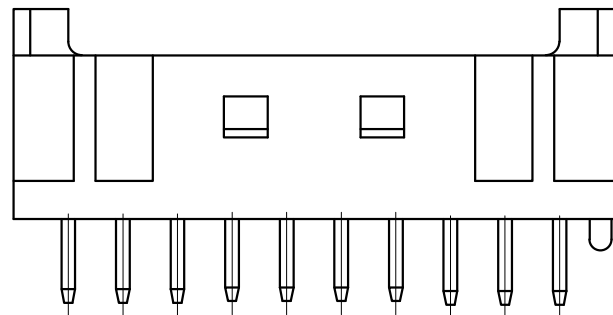

| Circuits | Product name | Dimensino(mm) |       |       | Circuits | Product name | Dimensino(mm) |       |       |
|----------|--------------|---------------|-------|-------|----------|--------------|---------------|-------|-------|
|          |              | A             | B     | C     |          |              | A             | B     | C     |
| 2        | PA-2AS       | 2.00          | 6.00  | 4.80  | 10       | PA-10AS      | 18.00         | 22.00 | 20.80 |
| 3        | PA-3AS       | 4.00          | 8.00  | 6.80  | 11       | PA-11AS      | 20.00         | 24.00 | 22.80 |
| 4        | PA-4AS       | 6.00          | 10.00 | 8.80  | 12       | PA-12AS      | 22.00         | 26.00 | 24.80 |
| 5        | PA-5AS       | 8.00          | 12.00 | 10.80 | 13       | PA-13AS      | 24.00         | 28.00 | 26.80 |
| 6        | PA-6AS       | 10.00         | 14.00 | 12.80 | 14       | PA-14AS      | 26.00         | 30.00 | 28.80 |
| 7        | PA-7AS       | 12.00         | 16.00 | 14.80 | 15       | PA-15AS      | 28.00         | 32.00 | 30.80 |
| 8        | PA-8AS       | 14.00         | 18.00 | 16.80 | 16       | PA-16AS      | 30.00         | 34.00 | 32.80 |
| 9        | PA-9AS       | 16.00         | 20.00 | 18.80 | -        | -            | -             | -     | -     |

|                                       |              |                                    |  |
|---------------------------------------|--------------|------------------------------------|--|
| GENERAL TOLERANCES (UNLESS SPECIFIED) |              | ZHE JIANG DELI CONNECTORS CO., LTD |  |
| .X: ± 0.25                            | .X°: ± 3.0°  | PRODUCT NAME:<br>DL20003(PA)-AS    | TITLE:<br>2.00 mm Pitch<br>Wire to Board Wafer |
| .XX: ± 0.15                           | .X°: ± 2.0°  | DR: Chen Quan Long                 | DATE:19/08/01                                  |
| .XXX: ± 0.01                          | .XX°: ± 1.0° | CHKD: Zhang Ren Chuan              | DATE:19/08/01                                  |
| FINISH:                               |              | APPD: Ren An De                    | DATE:19/08/01                                  |
| DRAWING NO:                           |              | SCALE: N/A                         | PAGE: 1/1                                      |
|                                       |              | UNITS: mm                          | REV.: A  |

|      |                      |  |  |      |      |  |  |  |  |
|------|----------------------|--|--|------|------|--|--|--|--|
|      |                      |  |  |      |      |  |  |  |  |
| REV. | REVISION DESCRIPTION |  |  | DATE | APPD |  |  |  |  |
|      |                      |  |  |      |      |  |  |  |  |

2PIN

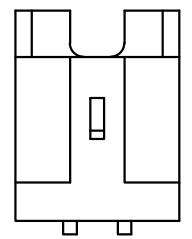

4-9PIN

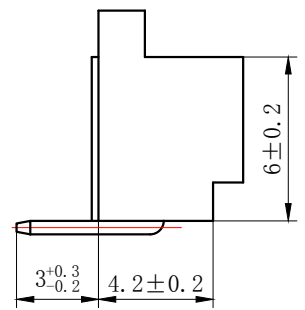
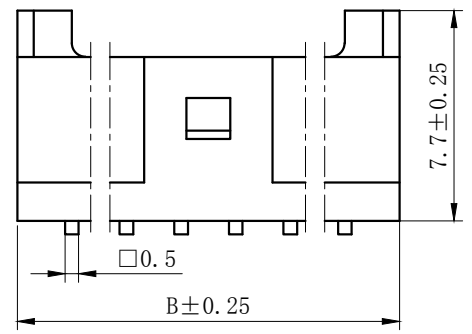

NOTES

Available in 02 through 16 Circuits.  
 Mates with DL20003-Y Series Housing.  
 Material : Nylon UL94V-0 (2) .  
 0.50mm Square Pin.  
 Pin Material : Brass / Tin-Plated.

3PIN

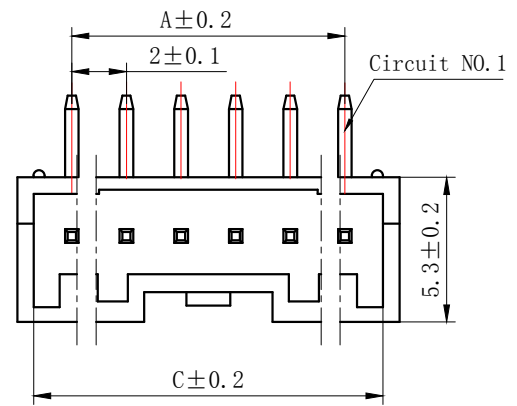
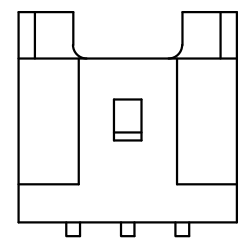

10PIN以上

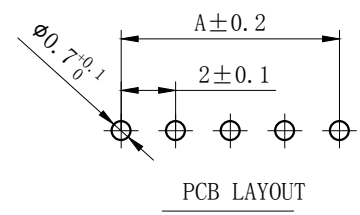
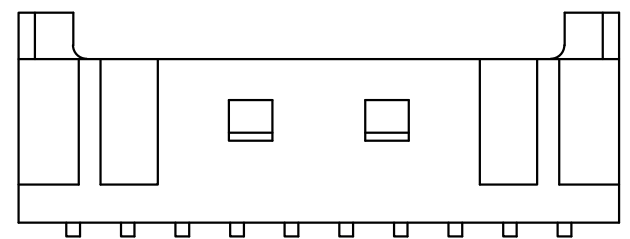

| Circuits | Product name | Dimensino (mm) |       |       | Circuits | Product name | Dimensino (mm) |       |       |
|----------|--------------|----------------|-------|-------|----------|--------------|----------------|-------|-------|
|          |              | A              | B     | C     |          |              | A              | B     | C     |
| 2        | PA-2AW       | 2.00           | 6.00  | 4.80  | 10       | PA-10AW      | 18.00          | 22.00 | 20.80 |
| 3        | PA-3AW       | 4.00           | 8.00  | 6.80  | 11       | PA-11AW      | 20.00          | 24.00 | 22.80 |
| 4        | PA-4AW       | 6.00           | 10.00 | 8.80  | 12       | PA-12AW      | 22.00          | 26.00 | 24.80 |
| 5        | PA-5AW       | 8.00           | 12.00 | 10.80 | 13       | PA-13AW      | 24.00          | 28.00 | 26.80 |
| 6        | PA-6AW       | 10.00          | 14.00 | 12.80 | 14       | PA-14AW      | 26.00          | 30.00 | 28.80 |
| 7        | PA-7AW       | 12.00          | 16.00 | 14.80 | 15       | PA-15AW      | 28.00          | 32.00 | 30.80 |
| 8        | PA-8AW       | 14.00          | 18.00 | 16.80 | 16       | PA-16AW      | 30.00          | 34.00 | 32.80 |
| 9        | PA-9AW       | 16.00          | 20.00 | 18.80 | -        | -            | -              | -     | -     |

|                                       |               |                                     |               |   |           |
|---------------------------------------|---------------|-------------------------------------|---------------|---|-----------|
| GENERAL TOLERANCES (UNLESS SPECIFIED) |               | ZHE JIANG DELI CONNECTORS CO ., LTD |               |   |           |
| .X: ± 0.25                            | X° : ± 3.0°   | PRODUCT NAME:<br>DL20003 (PA) -AW   |               | TITLE: 2.00 mm Pitch<br>Wire To Board Wafer |           |
| .XX: ± 0.15                           | .X° : ± 2.0°  | DR: Chen Quan Long                  | DATE:19/08/01 | PART NO:                                    |           |
| .XXX: ± 0.01                          | .XX° : ± 1.0° | CHKD:Zhang RenChuan                 | DATE:19/08/01 | SCALE: N/A                                  | PAGE: 1/1 |
| DRAWING NO:                           |               | APPD:Ren An De                      | DATE:19/08/01 | UNITS: mm                                   | REV.: A   |

| REV. | 7                    | 8         |
|------|----------------------|-----------|
|      | REVISION DESCRIPTION | DATE APPD |

2PIN

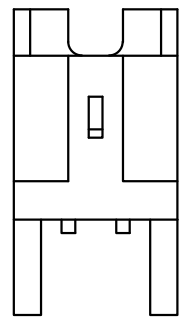

4-9PIN

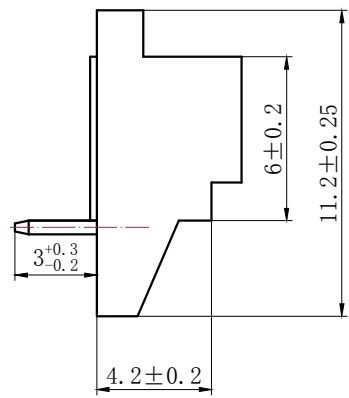
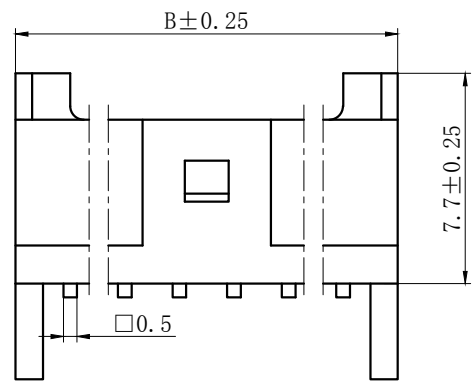

NOTES

Available in 02 through 16 Circuits.  
 Mates with DL20003-Y Series Housing.  
 Material : Nylon UL94V-0(2).  
 0.50mm Square Pin.  
 Pin Material : Brass / Tin-Plated.

3PIN

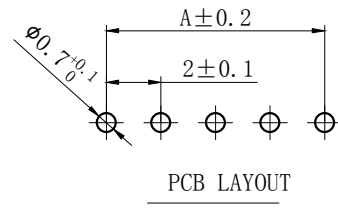
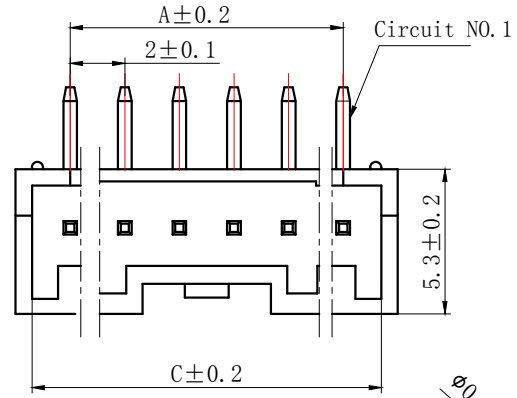
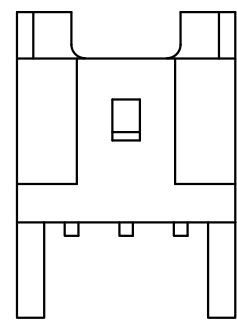

10PIN以上

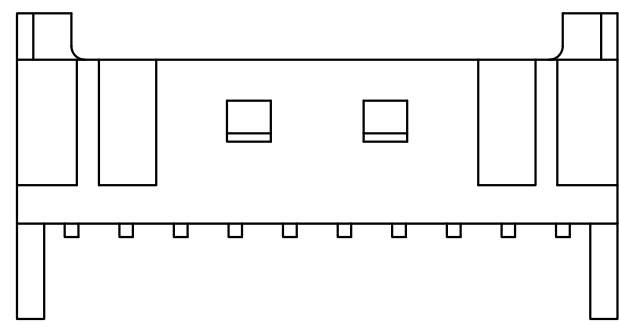

| Circuits | Product name | Dimensino(mm) |       |       | Circuits | Product name | Dimensino(mm) |       |       |
|----------|--------------|---------------|-------|-------|----------|--------------|---------------|-------|-------|
|          |              | A             | B     | C     |          |              | A             | B     | C     |
| 2        | PA-2AWD      | 2.00          | 6.00  | 4.80  | 10       | PA-10AWD     | 18.00         | 22.00 | 20.80 |
| 3        | PA-3AWD      | 4.00          | 8.00  | 6.80  | 11       | PA-11AWD     | 20.00         | 24.00 | 22.80 |
| 4        | PA-4AWD      | 6.00          | 10.00 | 8.80  | 12       | PA-12AWD     | 22.00         | 26.00 | 24.80 |
| 5        | PA-5AWD      | 8.00          | 12.00 | 10.80 | 13       | PA-13AWD     | 24.00         | 28.00 | 26.80 |
| 6        | PA-6AWD      | 10.00         | 14.00 | 12.80 | 14       | PA-14AWD     | 26.00         | 30.00 | 28.80 |
| 7        | PA-7AWD      | 12.00         | 16.00 | 14.80 | 15       | PA-15AWD     | 28.00         | 32.00 | 30.80 |
| 8        | PA-8AWD      | 14.00         | 18.00 | 16.80 | 16       | PA-16AWD     | 30.00         | 34.00 | 32.80 |
| 9        | PA-9AWD      | 16.00         | 20.00 | 18.80 | -        | -            | -             | -     | -     |

| GENERAL TOLERANCES (UNLESS SPECIFIED) |              | ZHE JIANG DELI CONNECTORS CO., LTD |  |
|---------------------------------------|--------------|------------------------------------|--|
| .X: ± 0.25                            | X°: ± 3.0°   | PRODUCT NAME:                      | TITLE: 2.00 mm Pitch Wire To Board Wafer |
| .XX: ± 0.15                           | .X°: ± 2.0°  | DL20003 (PA)-AWD                   |  |
| .XXX: ± 0.01                          | .XX°: ± 1.0° | DR: Chen Quan Long                 | DATE:19/08/01                            |
| FINISH:                               |              | CHKD: Wu Hui                       | DATE:19/08/01                            |
| DRAWING NO:                           |              | APPD:Ren An De                     | DATE:19/08/01                            |
|                                       |              | SCALE: N/A                         | PAGE: 1/1                                |
|                                       |              | UNITS: mm                          | REV.: A                                  |

|                      |      |      |
|----------------------|------|------|
| REV.                 | 7    | 8    |
| REVISION DESCRIPTION | DATE | APPD |

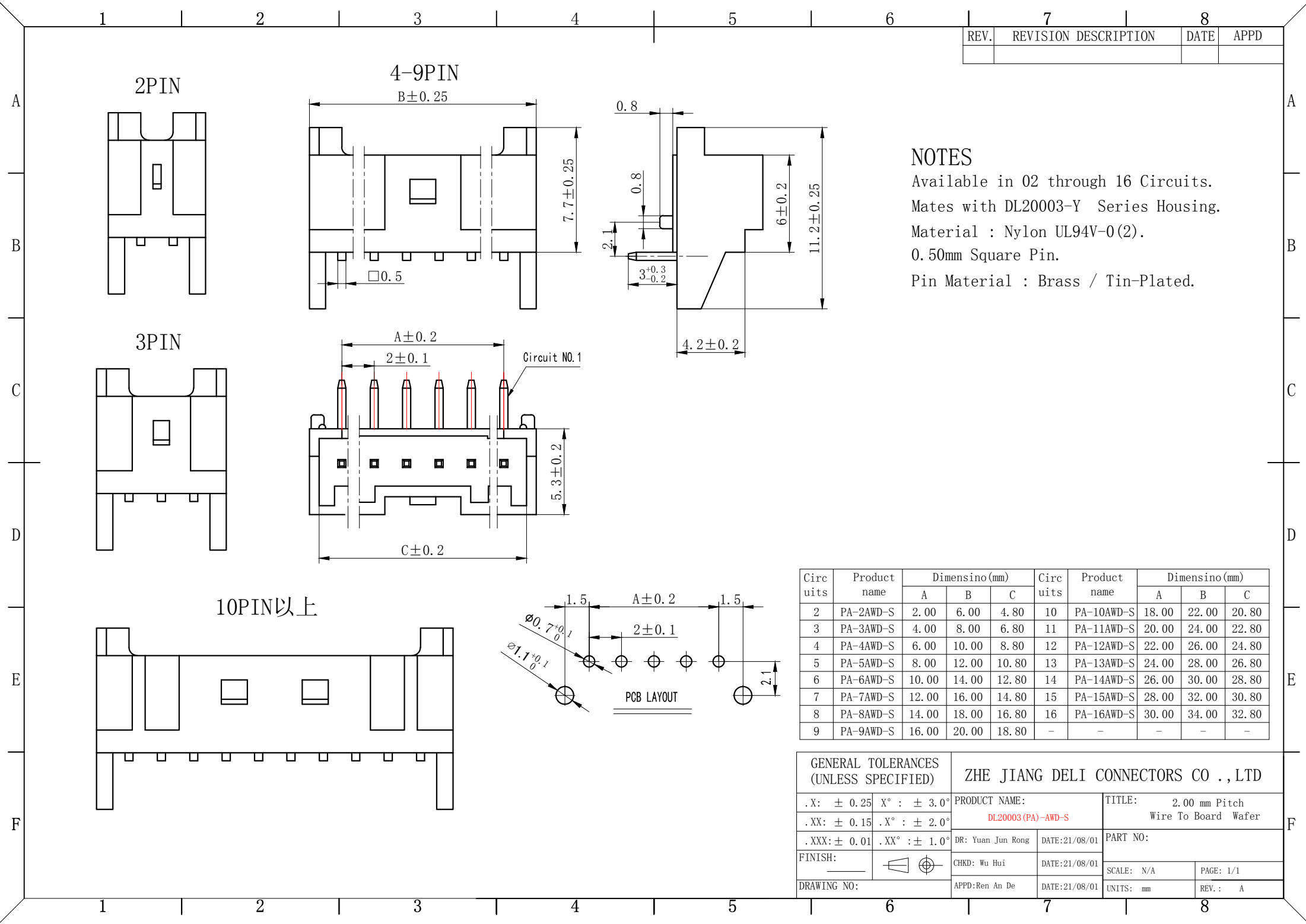

**NOTES**  
 Available in 02 through 16 Circuits.  
 Mates with DL20003-Y Series Housing.  
 Material : Nylon UL94V-0(2).  
 0.50mm Square Pin.  
 Pin Material : Brass / Tin-Plated.

| Circuits | Product name | Dimensino(mm) |       |       | Circuits | Product name | Dimensino(mm) |       |       |
|----------|--------------|---------------|-------|-------|----------|--------------|---------------|-------|-------|
|          |              | A             | B     | C     |          |              | A             | B     | C     |
| 2        | PA-2AWD-S    | 2.00          | 6.00  | 4.80  | 10       | PA-10AWD-S   | 18.00         | 22.00 | 20.80 |
| 3        | PA-3AWD-S    | 4.00          | 8.00  | 6.80  | 11       | PA-11AWD-S   | 20.00         | 24.00 | 22.80 |
| 4        | PA-4AWD-S    | 6.00          | 10.00 | 8.80  | 12       | PA-12AWD-S   | 22.00         | 26.00 | 24.80 |
| 5        | PA-5AWD-S    | 8.00          | 12.00 | 10.80 | 13       | PA-13AWD-S   | 24.00         | 28.00 | 26.80 |
| 6        | PA-6AWD-S    | 10.00         | 14.00 | 12.80 | 14       | PA-14AWD-S   | 26.00         | 30.00 | 28.80 |
| 7        | PA-7AWD-S    | 12.00         | 16.00 | 14.80 | 15       | PA-15AWD-S   | 28.00         | 32.00 | 30.80 |
| 8        | PA-8AWD-S    | 14.00         | 18.00 | 16.80 | 16       | PA-16AWD-S   | 30.00         | 34.00 | 32.80 |
| 9        | PA-9AWD-S    | 16.00         | 20.00 | 18.80 | -        | -            | -             | -     | -     |

|                                       |              |                                    |  |
|---------------------------------------|--------------|------------------------------------|--|
| GENERAL TOLERANCES (UNLESS SPECIFIED) |              | ZHE JIANG DELI CONNECTORS CO., LTD |  |
| .X: ± 0.25                            | X°: ± 3.0°   | PRODUCT NAME:<br>DL20003(PA)-AWD-S | TITLE:<br>2.00 mm Pitch<br>Wire To Board Wafer |
| .XX: ± 0.15                           | .X°: ± 2.0°  | DR: Yuan Jun Rong                  | DATE:21/08/01                                  |
| .XXX: ± 0.01                          | .XX°: ± 1.0° | CHKD: Wu Hui                       | DATE:21/08/01                                  |
| FINISH:                               |              | APPD:Ren An De                     | DATE:21/08/01                                  |
| DRAWING NO:                           |              |                                    |  |
|                                       |              | SCALE: N/A                         | PAGE: 1/1                                      |
|                                       |              | UNITS: mm                          | REV.: A  |



| REV. | REVISION DESCRIPTION | DATE | APPD |
|------|----------------------|------|------|
|      |                      |      |      |

### NOTES

Available in 02 through 16 Circuits.  
 Mates with DL20035-Y Series Housing.  
 Material : Nylon UL94V-0 (2) .  
 0.50mm Square Pin.  
 Pin Material : Brass / Tin-Plated.

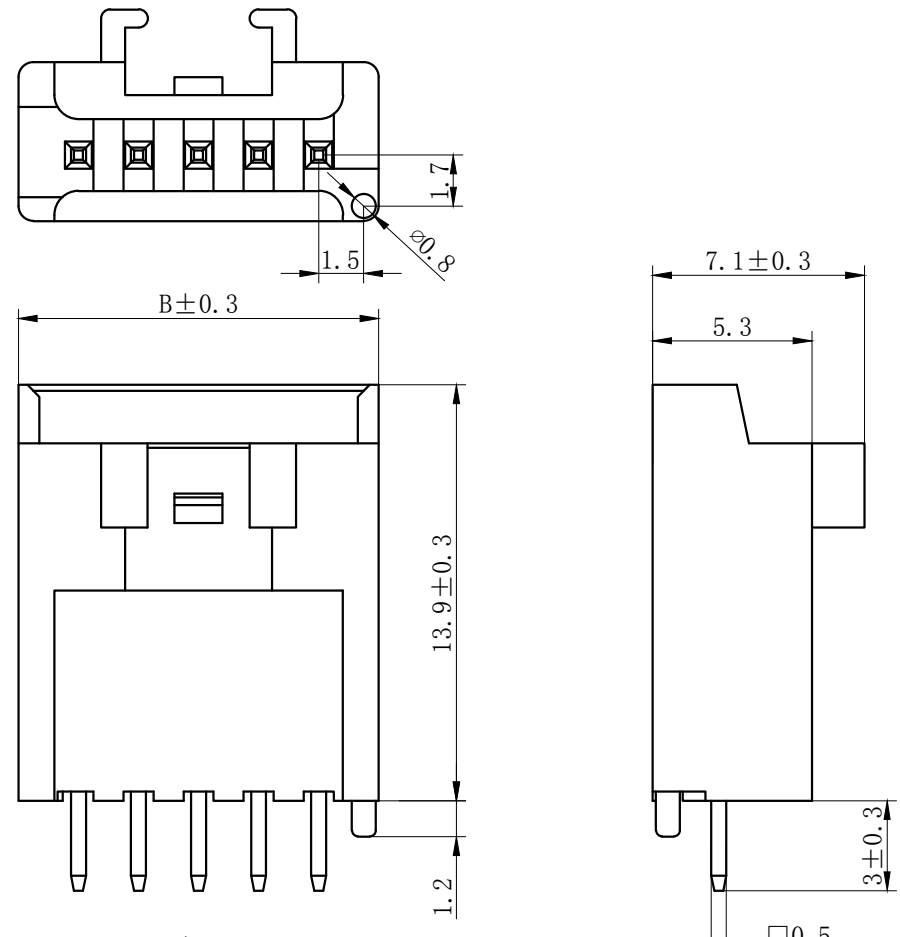

| Circuits | Product name | Dimensino (mm) |      |
|----------|--------------|----------------|------|
|          |              | A              | B    |
| 2        | PA-H-2AS     | 2.0            | 6.0  |
| 3        | PA-H-3AS     | 4.0            | 8.0  |
| 4        | PA-H-4AS     | 6.0            | 10.0 |
| 5        | PA-H-5AS     | 8.0            | 12.0 |
| 6        | PA-H-6AS     | 10.0           | 14.0 |
| 7        | PA-H-7AS     | 12.0           | 16.0 |
| 8        | PA-H-8AS     | 14.0           | 18.0 |
| 9        | PA-H-9AS     | 16.0           | 20.0 |
| 10       | PA-H-10AS    | 18.0           | 22.0 |
| 11       | PA-H-11AS    | 20.0           | 24.0 |
| 12       | PA-H-12AS    | 22.0           | 26.0 |
| 13       | PA-H-13AS    | 24.0           | 28.0 |
| 14       | PA-H-14AS    | 26.0           | 30.0 |
| 15       | PA-H-15AS    | 28.0           | 32.0 |
| 16       | PA-H-16AS    | 30.0           | 34.0 |

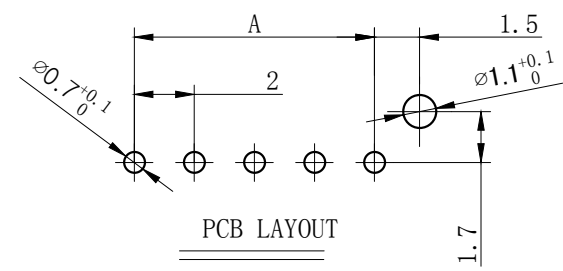

|                                       |                       |   |  |
|---------------------------------------|-----------------------|---|--|
| GENERAL TOLERANCES (UNLESS SPECIFIED) |                       | ZHE JIANG DELI CONNECTORS CO., LTD        |  |
| .X: $\pm 0.25$                        | X°: $\pm 3.0^\circ$   | PRODUCT NAME:<br><b>DL20035 (PA-H)-AS</b> | TITLE:<br>2.00 mm Pitch<br>Wire To Board Wafer |
| .XX: $\pm 0.15$                       | .X°: $\pm 2.0^\circ$  | DR: Zhang Wen Jing                        | DATE: 09/08/01                                 |
| .XXX: $\pm 0.01$                      | .XX°: $\pm 1.0^\circ$ | CHKD: Wu Hui                              | DATE: 09/08/01                                 |
| DRAWING NO:                           |                       | APPD: Ren An De                           | DATE: 09/08/01                                 |
| FINISH:                               |                       | SCALE: N/A                                | PAGE: 1/1                                      |
|                                       |                       | UNITS: mm                                 | REV.: A  |

| REV. | REVISION DESCRIPTION | DATE | APPD |
|------|----------------------|------|------|
|      |                      |      |      |

### NOTES

Available in 02 through 05 Circuits.  
Mates with DL20035-Y Series Housing.  
Material : Nylon UL94V-0(2).  
Accepts DL20035-RT Crimp Terminal.

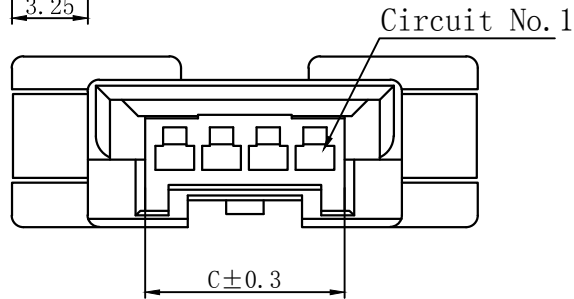
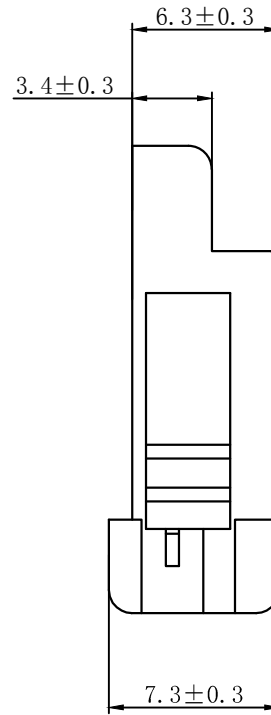
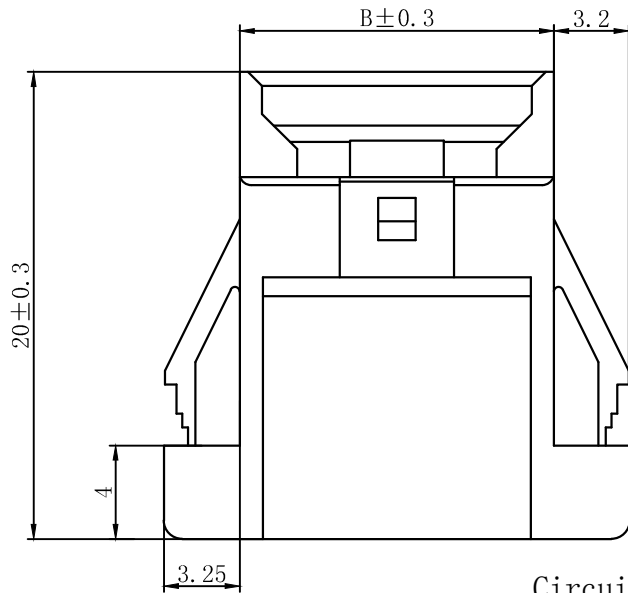
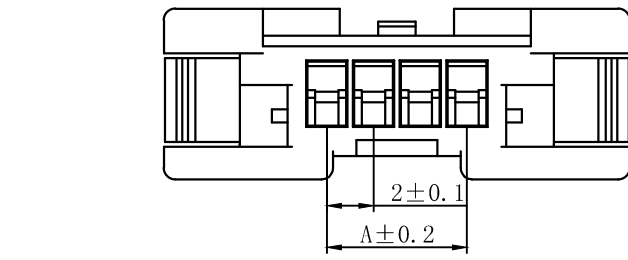
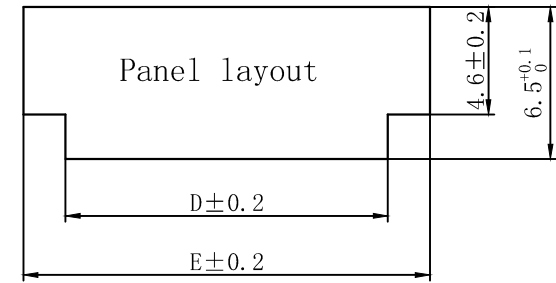

| Circuits | Product name | Dimension mm |       |       |       |       |
|----------|--------------|--------------|-------|-------|-------|-------|
|          |              | A            | B     | C     | D     | E     |
| 2        | PA-H-2R      | 2.00         | 9.40  | 4.55  | 9.80  | 13.40 |
| 3        | PA-H-3R      | 4.00         | 11.40 | 6.55  | 11.80 | 15.40 |
| 4        | PA-H-4R      | 6.00         | 13.40 | 8.55  | 13.80 | 17.40 |
| 5        | PA-H-5R      | 8.00         | 15.40 | 10.55 | 15.80 | 19.40 |

|  |                        |  |                |  |           |
|--|------------------------|--|----------------|--|-----------|
| GENERAL TOLERANCES<br>(UNLESS SPECIFIED) |                        | ZHE JIANG DELI CONNECTORS CO., LTD       |                |  |           |
| .X: $\pm 0.25$                           | X°: $\pm 3.0^\circ$    | PRODUCT NAME:<br><b>DL20035 (PA-H)-R</b> |                | TITLE: 2.00 mm Pitch<br>Wire To Wire Housing |           |
| .XX: $\pm 0.15$                          | .XX°: $\pm 2.0^\circ$  | DR: Chen Quan Long                       | DATE: 22/10/12 | PART NO:                                     |           |
| .XXX: $\pm 0.01$                         | .XXX°: $\pm 1.0^\circ$ | CHKD: Wu Hui                             | DATE: 22/10/12 | SCALE: N/A                                   | PAGE: 1/1 |
| DRAWING NO:                              |                        | APPD: Ren An De                          | DATE: 22/10/12 | UNITS: mm                                    | REV.: A   |

|      |                      |      |      |
|------|----------------------|------|------|
| REV. | REVISION DESCRIPTION | DATE | APPD |
|      |                      |      |      |

NOTES

Available in 06 through 15 Circuits.  
 Mates with DL20035-Y Series Housing.  
 Material : Nylon UL94V-0(2).  
 Accepts DL20035-RT Crimp Terminal.

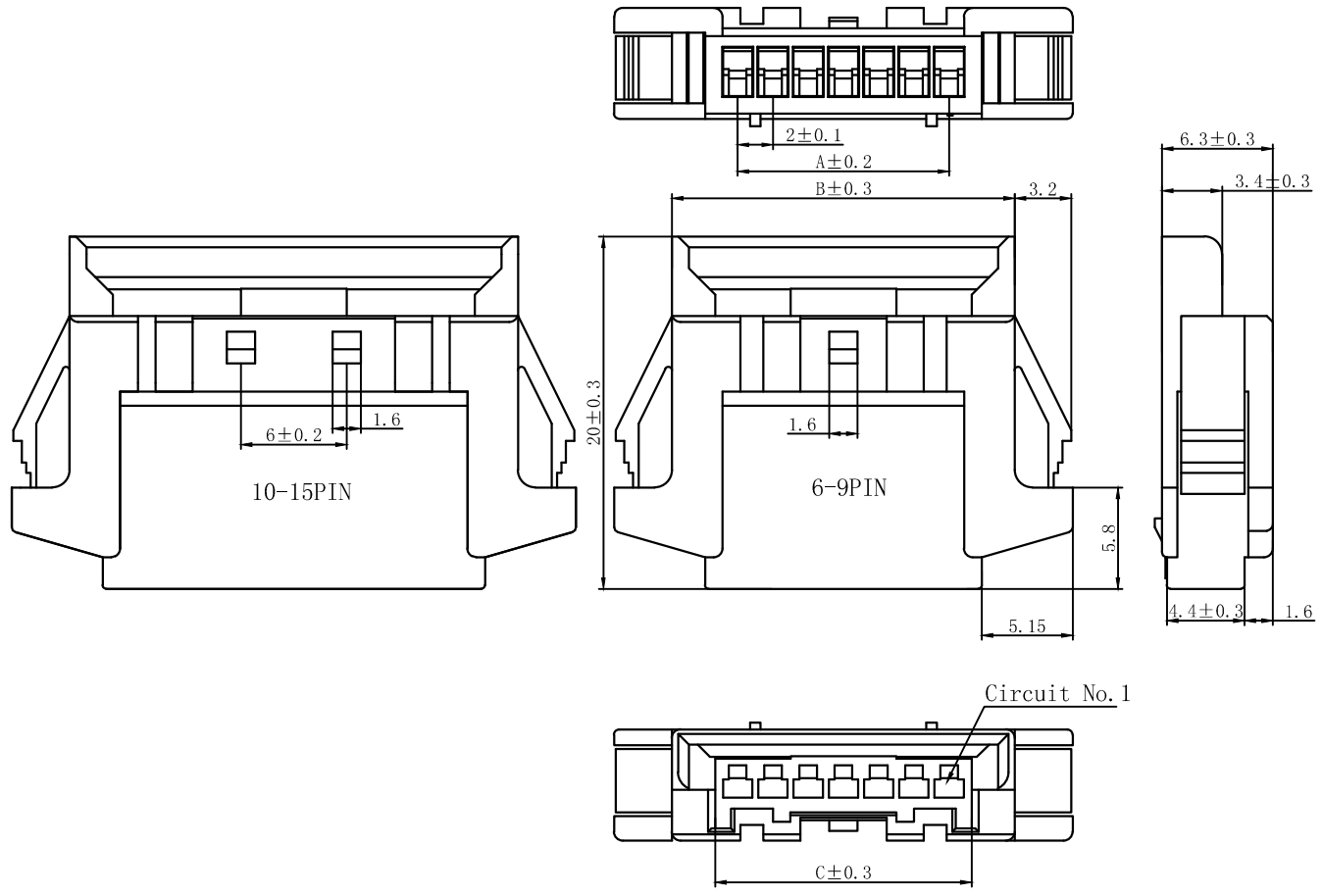

| Circuits | Product name | Dimension mm |       |       |       |       |
|----------|--------------|--------------|-------|-------|-------|-------|
|          |              | A            | B     | C     | D     | E     |
| 6        | PA-H-6R      | 10.00        | 17.40 | 12.55 | 19.80 | 21.40 |
| 7        | PA-H-7R      | 12.00        | 19.40 | 14.55 | 21.80 | 23.40 |
| 8        | PA-H-8R      | 14.00        | 21.40 | 16.55 | 23.80 | 25.40 |
| 9        | PA-H-9R      | 16.00        | 23.40 | 18.55 | 25.80 | 27.40 |
| 10       | PA-H-10R     | 18.00        | 25.40 | 20.55 | 27.80 | 29.40 |
| 11       | PA-H-11R     | 20.00        | 27.40 | 22.55 | 29.80 | 31.40 |
| 12       | PA-H-12R     | 22.00        | 29.40 | 24.55 | 31.80 | 33.40 |
| 13       | PA-H-13R     | 24.00        | 31.40 | 26.55 | 33.80 | 35.40 |
| 14       | PA-H-14R     | 26.00        | 33.40 | 28.55 | 35.80 | 37.40 |
| 15       | PA-H-15R     | 28.00        | 35.40 | 30.55 | 37.80 | 39.40 |

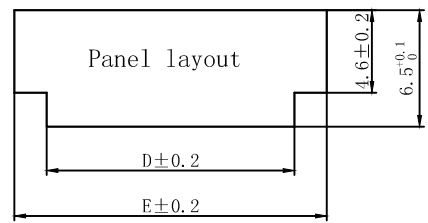

|                                       |                       |                                    |                |  |           |
|---------------------------------------|-----------------------|------------------------------------|----------------|--|-----------|
| GENERAL TOLERANCES (UNLESS SPECIFIED) |                       | ZHE JIANG DELI CONNECTORS CO., LTD |                |  |           |
| .X: $\pm 0.25$                        | X°: $\pm 3.0^\circ$   | PRODUCT NAME:<br>DL20035 (PA-H)-R  |                | TITLE:<br>2.00 mm Pitch Wire To Wire Housing |           |
| .XX: $\pm 0.15$                       | .X°: $\pm 2.0^\circ$  | DR: Chen Quan Long                 | DATE: 22/10/12 | PART NO:                                     |           |
| .XXX: $\pm 0.01$                      | .XX°: $\pm 1.0^\circ$ | CHKD: Wu Hui                       | DATE: 22/10/12 | SCALE: N/A                                   | PAGE: 1/1 |
| DRAWING NO:                           |                       | APPD: Ren An De                    | DATE: 22/10/12 | UNITS: mm                                    | REV.: A   |

| REV. | REVISION DESCRIPTION | DATE | APPD |
|------|----------------------|------|------|
|      |                      |      |      |

### NOTES

Available in 02 through 05 Circuits.  
 Mates with DL20035-Y Series Housing.  
 Material : Nylon UL94V-0(2).  
 Accepts DL20035-RT Crimp Terminal.

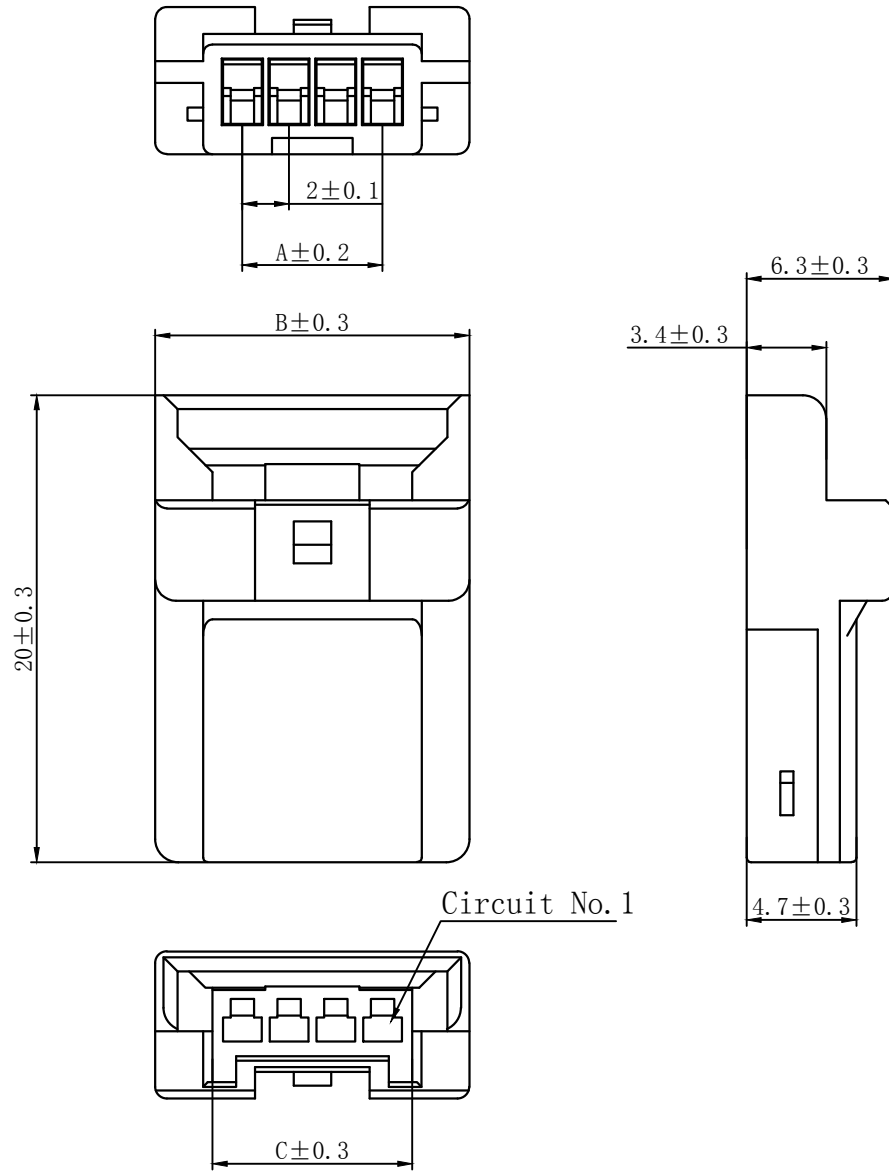

| Circuits | Product name | Dimension mm |       |       |
|----------|--------------|--------------|-------|-------|
|          |              | A            | B     | C     |
| 2        | PA-H-2RF     | 2.00         | 9.40  | 4.55  |
| 3        | PA-H-3RF     | 4.00         | 11.40 | 6.55  |
| 4        | PA-H-4RF     | 6.00         | 13.40 | 8.55  |
| 5        | PA-H-5RF     | 8.00         | 15.40 | 10.55 |

| GENERAL TOLERANCES (UNLESS SPECIFIED) |               | ZHE JIANG DELI CONNECTORS CO., LTD        |               |
|---------------------------------------|---------------|---|---------------|
| .X: ± 0.25                            | X° : ± 3.0°   | PRODUCT NAME: DL20035 (PA-H)-RF           |               |
| .XX: ± 0.15                           | .X° : ± 2.0°  | TITLE: 2.00 mm Pitch Wire To Wire Housing |               |
| .XXX: ± 0.01                          | .XX° : ± 1.0° | DR: Chen Quan Long                        | DATE:22/10/12 |
| FINISH: _____                         |               | CHKD: Wu Hui                              | DATE:22/10/12 |
| DRAWING NO:                           |               | APPD:Ren An De                            | DATE:22/10/12 |
|                                       |               | SCALE: N/A                                | PAGE: 1/1     |
|                                       |               | UNITS: mm                                 | REV.: A       |

|      |                      |      |      |
|------|----------------------|------|------|
| REV. | REVISION DESCRIPTION | DATE | APPD |
|      |                      |      |      |

NOTES

Available in 06 through 15 Circuits.  
 Mates with DL20035-Y Series Housing.  
 Material : Nylon UL94V-0(2).  
 Accepts DL20035-RT Crimp Terminal.

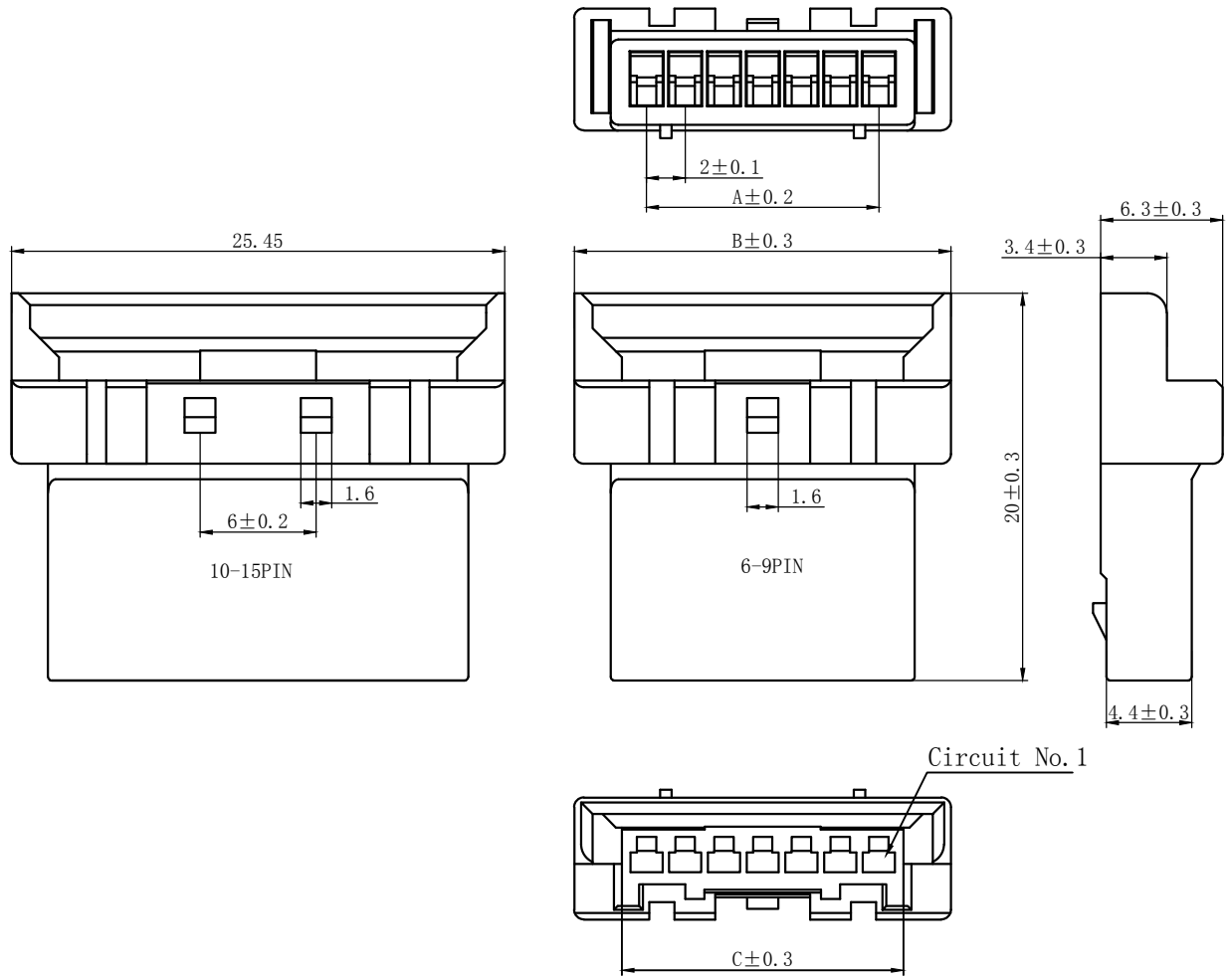

| Circuits | Product name | Dimension mm |       |       |
|----------|--------------|--------------|-------|-------|
|          |              | A            | B     | C     |
| 6        | PA-H-6RF     | 10.00        | 17.40 | 12.55 |
| 7        | PA-H-7RF     | 12.00        | 19.40 | 14.55 |
| 8        | PA-H-8RF     | 14.00        | 21.40 | 16.55 |
| 9        | PA-H-9RF     | 16.00        | 23.40 | 18.55 |
| 10       | PA-H-10RF    | 18.00        | 25.40 | 20.55 |
| 11       | PA-H-11RF    | 20.00        | 27.40 | 22.55 |
| 12       | PA-H-12RF    | 22.00        | 29.40 | 24.55 |
| 13       | PA-H-13RF    | 24.00        | 31.40 | 26.55 |
| 14       | PA-H-14RF    | 26.00        | 33.40 | 28.55 |
| 15       | PA-H-15RF    | 28.00        | 35.40 | 30.55 |

|  |              |                                    |   |
|--|--------------|------------------------------------|---|
| GENERAL TOLERANCES<br>(UNLESS SPECIFIED) |              | ZHE JIANG DELI CONNECTORS CO., LTD |   |
| .X: ± 0.25                               | X°: ± 3.0°   | PRODUCT NAME:<br>DL20035 (PA-H)-RF | TITLE:<br>2.00 mm Pitch<br>Wire To Wire Housing |
| .XX: ± 0.15                              | .X°: ± 2.0°  | DR: Chen Quan Long                 | DATE:22/10/12                                   |
| .XXX: ± 0.01                             | .XX°: ± 1.0° | CHKD: Wu Hui                       | DATE:22/10/12                                   |
| FINISH:                                  |              | APPD: Ren An De                    | DATE:22/10/12                                   |
| DRAWING NO:                              |              |                                    |   |

A  
B  
C  
D  
E  
F

A  
B  
C  
D  
E  
F

1 2 3 4 5 6 7 8

1 2 3 4 5 6 7 8

| REV.                 | 7    | 8    |
|----------------------|------|------|
| REVISION DESCRIPTION | DATE | APPD |
|                      |      |      |

A  
B  
C  
D  
E  
F

A  
B  
C  
D  
E  
F

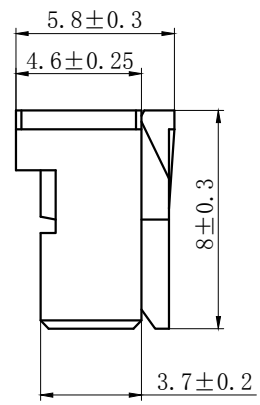
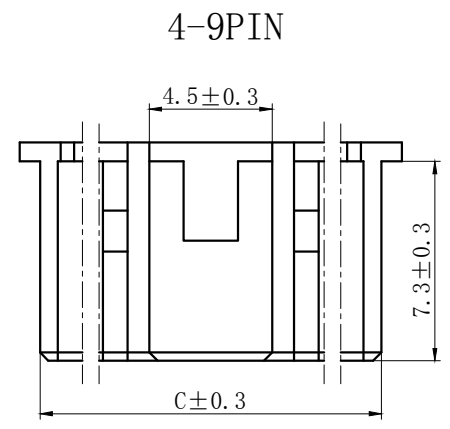
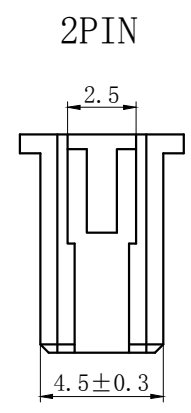

### NOTES

Available in 02 through 16 Circuits.  
Match with DL20003 series housing.  
Material : Nylon UL94V-0 (2) .  
Accepts DL20003-T Crimp Terminal.

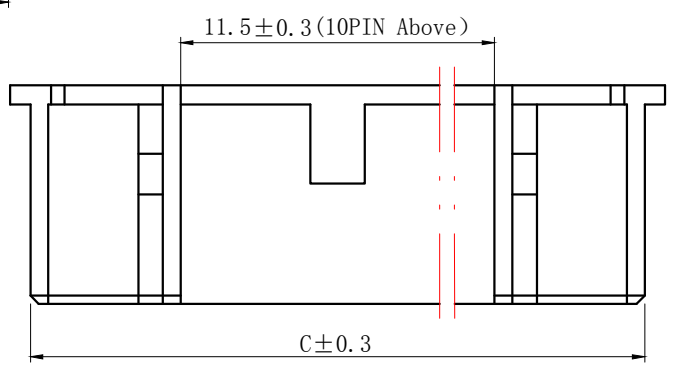
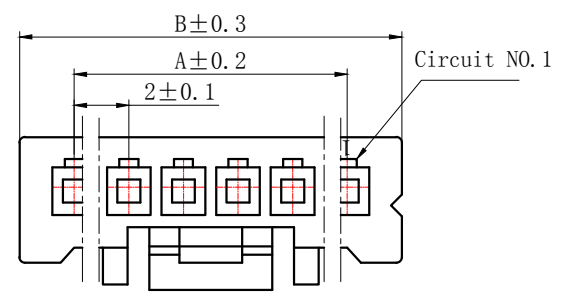
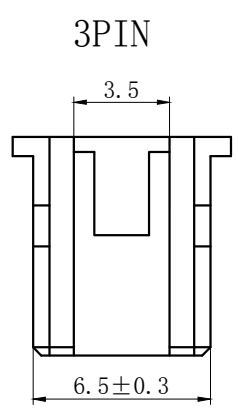

| Circuits | PRODUCT NAME | Dimension mm |      |      | Circuits | PRODUCT NAME | Dimension mm |      |      |
|----------|--------------|--------------|------|------|----------|--------------|--------------|------|------|
|          |              | A            | B    | C    |          |              | A            | B    | C    |
| 2        | PA-2Y        | 2.0          | 6.0  | 4.5  | 10       | PA-10Y       | 18.0         | 22.0 | 20.5 |
| 3        | PA-3Y        | 4.0          | 8.0  | 6.5  | 11       | PA-11Y       | 20.0         | 24.0 | 22.5 |
| 4        | PA-4Y        | 6.0          | 10.0 | 8.5  | 12       | PA-12Y       | 22.0         | 26.0 | 24.5 |
| 5        | PA-5Y        | 8.0          | 12.0 | 10.5 | 13       | PA-13Y       | 24.0         | 28.0 | 26.5 |
| 6        | PA-6Y        | 10.0         | 14.0 | 12.5 | 14       | PA-14Y       | 26.0         | 30.0 | 28.5 |
| 7        | PA-7Y        | 12.0         | 16.0 | 14.5 | 15       | PA-15Y       | 28.0         | 32.0 | 30.5 |
| 8        | PA-8Y        | 14.0         | 18.0 | 16.5 | 16       | PA-16Y       | 30.0         | 34.0 | 32.5 |
| 9        | PA-9Y        | 16.0         | 20.0 | 18.5 |          |              |              |      |      |

|                                       |               |                                     |                                 |
|---------------------------------------|---------------|-------------------------------------|---------------------------------|
| GENERAL TOLERANCES (UNLESS SPECIFIED) |               | ZHE JIANG DELI CONNECTORS CO ., LTD |                                 |
| .X: ± 0.25                            | X° : ± 3.0°   | PRODUCT NAME:<br>DL20003 (PA)-Y     | TITLE:<br>2.00 mm Pitch Housing |
| .XX: ± 0.15                           | .X° : ± 2.0°  | DR: Chen Quan Long                  | DATE:19/08/01                   |
| .XXX: ± 0.01                          | .XX° : ± 1.0° | CHKD:Wu Hui                         | DATE:19/08/01                   |
| FINISH:                               |               | APPD:Ren An De                      | DATE:19/08/01                   |
| DRAWING NO:                           |               |                                     |                                 |
|                                       |               | SCALE: N/A                          | PAGE: 1/1                       |
|                                       |               | UNITS: mm                           | REV.: A                         |

1 2 3 4 5 6 7 8

| REV. | REVISION DESCRIPTION | DATE | APPD |
|------|----------------------|------|------|
|      |                      |      |      |

### NOTES

Available in 02 through 16 Circuits.  
 Match with DL20035-AS series Wafer.  
 Material : Nylon UL94V-0 (2) .  
 Accepts DL20035-T Crimp Terminal.

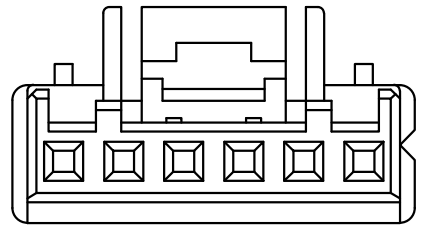

A

B

C

D

E

F

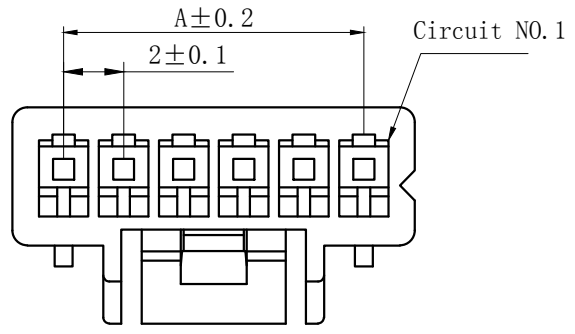
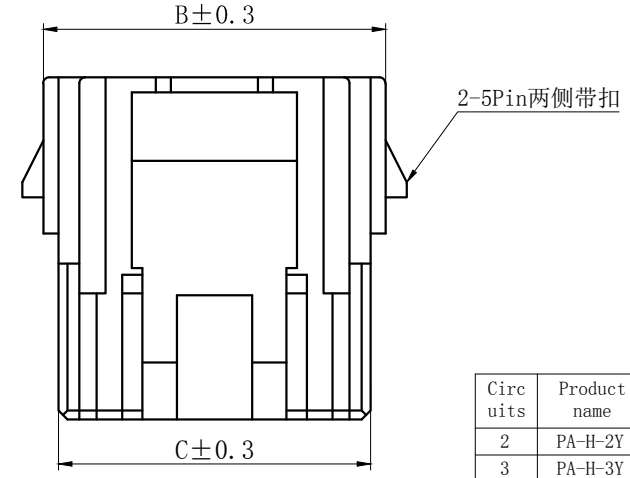
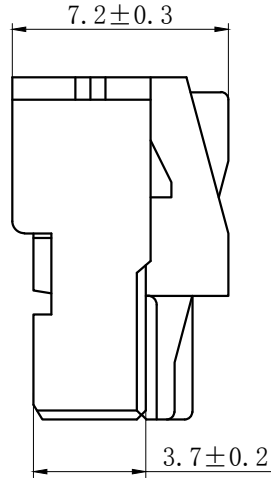
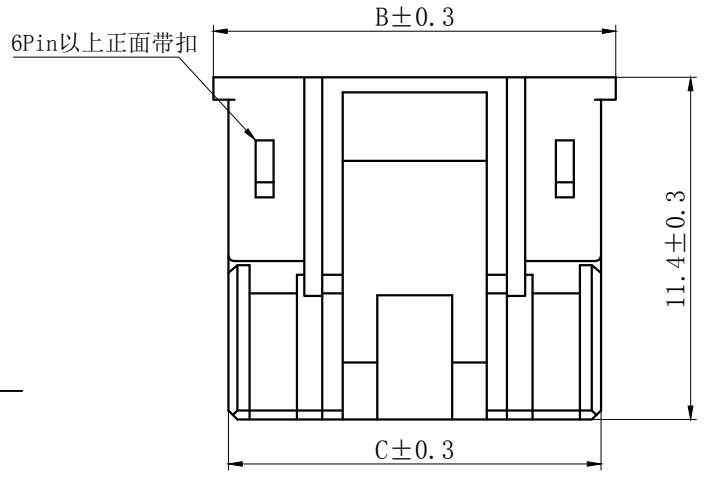

| Circuits | Product name | Dimensino (mm) |      |      |
|----------|--------------|----------------|------|------|
|          |              | A              | B    | C    |
| 2        | PA-H-2Y      | 2.0            | 5.4  | 4.5  |
| 3        | PA-H-3Y      | 4.0            | 7.4  | 6.5  |
| 4        | PA-H-4Y      | 6.0            | 9.4  | 8.5  |
| 5        | PA-H-5Y      | 8.0            | 11.4 | 10.5 |
| 6        | PA-H-6Y      | 10.0           | 13.4 | 12.5 |
| 7        | PA-H-7Y      | 12.0           | 15.4 | 14.5 |
| 8        | PA-H-8Y      | 14.0           | 17.4 | 16.5 |
| 9        | PA-H-9Y      | 16.0           | 19.4 | 18.5 |
| 10       | PA-H-10Y     | 18.0           | 21.4 | 20.5 |
| 11       | PA-H-11Y     | 20.0           | 23.4 | 22.5 |
| 12       | PA-H-12Y     | 22.0           | 25.4 | 24.5 |
| 13       | PA-H-13Y     | 24.0           | 27.4 | 26.5 |
| 14       | PA-H-14Y     | 26.0           | 29.4 | 28.5 |
| 15       | PA-H-15Y     | 28.0           | 31.4 | 30.5 |
| 16       | PA-H-16Y     | 30.0           | 33.4 | 32.5 |

|                                       |               |                                     |                       |
|---------------------------------------|---------------|-------------------------------------|-----------------------|
| GENERAL TOLERANCES (UNLESS SPECIFIED) |               | ZHE JIANG DELI CONNECTORS CO ., LTD |                       |
| .X: ± 0.25                            | X° : ± 3.0°   | PRODUCT NAME:                       | TITLE:                |
| .XX: ± 0.15                           | .X° : ± 2.0°  | DL20035 (PA-H)-Y                    | 2.00 mm Pitch Housing |
| .XXX: ± 0.01                          | .XX° : ± 1.0° | DR: Chen Quan Long                  | DATE:22/08/01         |
| FINISH:                               |               | CHKD:Wu Hui                         | DATE:22/08/01         |
| DRAWING NO:                           |               | APPD:Ren An De                      | DATE:22/08/01         |
|                                       |               |                                     | PART NO:              |
|                                       |               |                                     | SCALE: N/A            |
|                                       |               |                                     | PAGE: 1/1             |
|                                       |               |                                     | UNITS: mm             |
|                                       |               |                                     | REV.: A               |

1 2 3 4 5 6 7 8

1 2 3 4 5 6 7 8

| REV. | REVISION DESCRIPTION | DATE | APPD |
|------|----------------------|------|------|
|      |                      |      |      |

### NOTES

Available in 02 through 05 Circuits.  
 Mates with DL20035-Y Series Housing.  
 Material : Nylon UL94V-0(2).  
 Green Material RoHS Compliant.

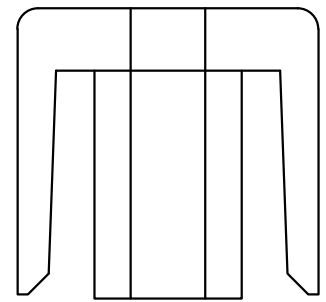
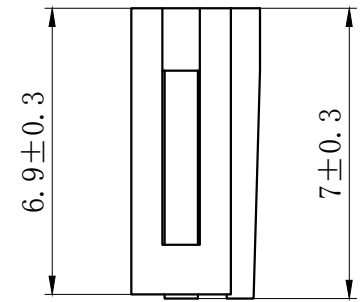
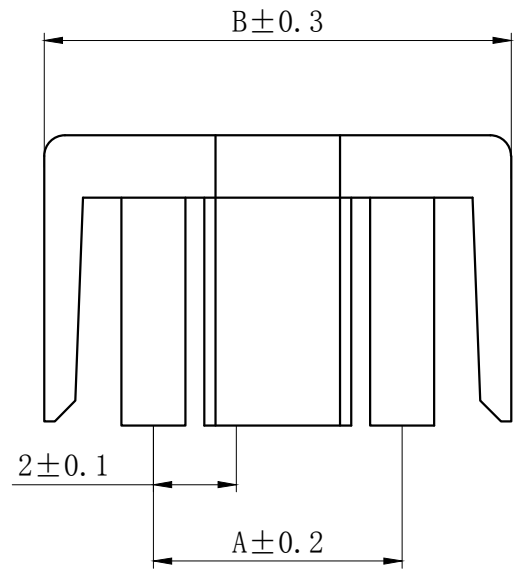
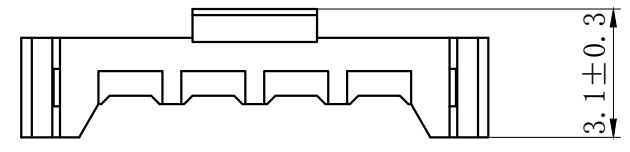

| Circuits | Product name | Dimensino (mm) |      |
|----------|--------------|----------------|------|
|          |              | A              | B    |
| 2        | PA-H-2S      | 2.0            | 7.3  |
| 3        | PA-H-3S      | 4.0            | 9.3  |
| 4        | PA-H-4S      | 6.0            | 11.3 |
| 5        | PA-H-5S      | 8.0            | 13.3 |

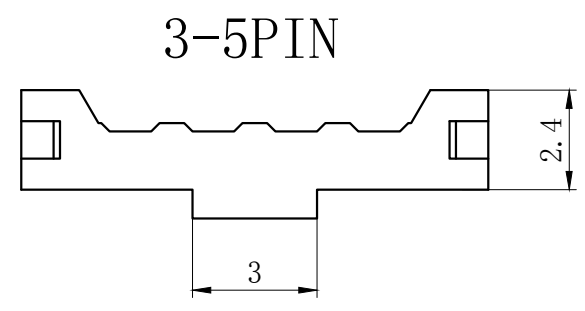
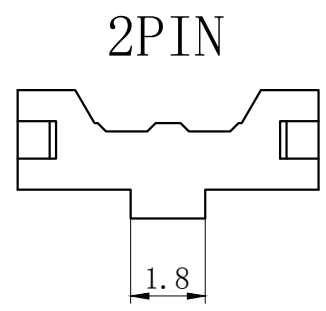

| GENERAL TOLERANCES (UNLESS SPECIFIED) |               | ZHE JIANG DELI CONNECTORS CO ., LTD |                                   |
|---------------------------------------|---------------|-------------------------------------|-----------------------------------|
| .X: ± 0.25                            | X° : ± 3.0°   | PRODUCT NAME:                       | TITLE: 2.0 mm Pitch Wire To Board |
| .XX: ± 0.15                           | .X° : ± 2.0°  | DL20035 (PA-H)-S                    |                                   |
| .XXX: ± 0.01                          | .XX° : ± 1.0° | DR: Chen Quan Long                  | DATE:19/08/01                     |
| FINISH:                               |               | CHKD: Wu Hui                        | DATE:19/08/01                     |
| DRAWING NO:                           |               | APPD:Ren An De                      | DATE:19/08/01                     |
|                                       |               |                                     | PART NO:                          |
|                                       |               |                                     | SCALE: N/A                        |
|                                       |               |                                     | PAGE: 1/2                         |
|                                       |               |                                     | UNITS: mm                         |
|                                       |               |                                     | REV.: A                           |



|      |                      |      |      |
|------|----------------------|------|------|
| REV. | REVISION DESCRIPTION | DATE | APPD |
|      |                      |      |      |

NOTES

Available in 06 through 16 Circuits.  
Mates with DL20035-Y Series Housing.  
Material : Nylon UL94V-0(2).  
Green Material RoHS Compliant.

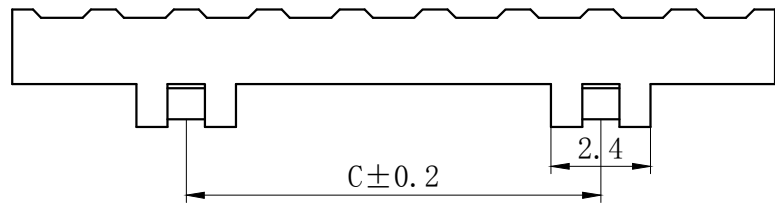
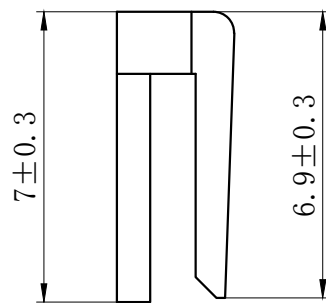
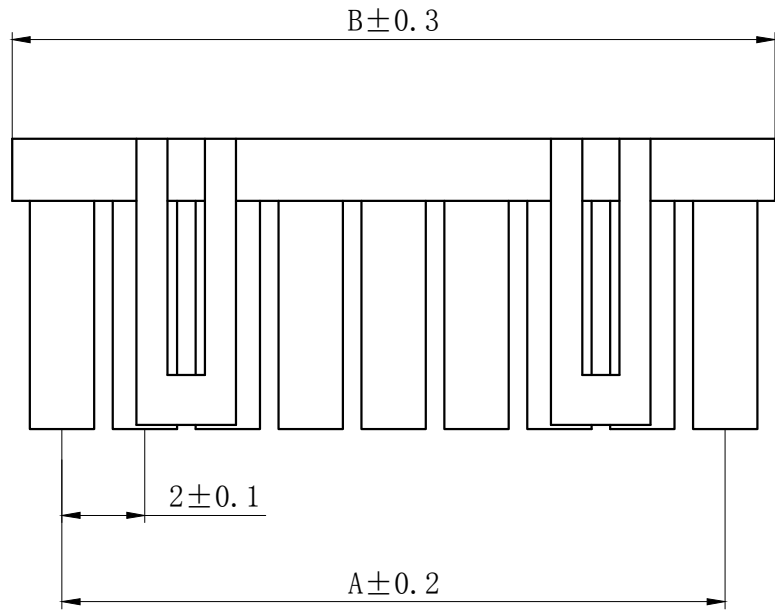
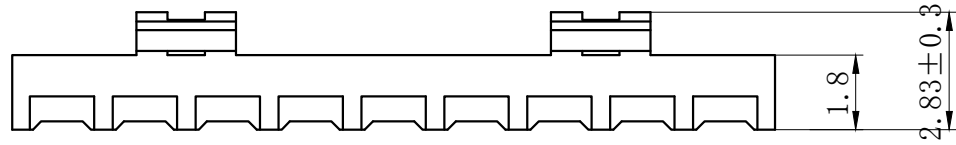

| Circuits | Product name | Dimensino(mm) |      |      |
|----------|--------------|---------------|------|------|
|          |              | A             | B    | C    |
| 6        | PA-H-6S      | 10.0          | 12.4 | 10.0 |
| 7        | PA-H-7S      | 12.0          | 14.4 | 10.0 |
| 8        | PA-H-8S      | 14.0          | 16.4 | 10.0 |
| 9        | PA-H-9S      | 16.0          | 18.4 | 10.0 |
| 10       | PA-H-10S     | 18.0          | 20.4 | 17.4 |
| 11       | PA-H-11S     | 20.0          | 22.4 | 17.4 |
| 12       | PA-H-12S     | 22.0          | 24.4 | 17.4 |
| 13       | PA-H-13S     | 24.0          | 26.4 | 17.4 |
| 14       | PA-H-14S     | 26.0          | 28.4 | 17.4 |
| 15       | PA-H-15S     | 28.0          | 30.4 | 17.4 |
| 16       | PA-H-16S     | 30.0          | 32.4 | 17.4 |

|  |              |  |   |
|--|--------------|--|---|
| GENERAL TOLERANCES<br>(UNLESS SPECIFIED) |              | ZHE JIANG DELI CONNECTORS CO., LTD       |   |
| .X: ± 0.25                               | X°: ± 3.0°   | PRODUCT NAME:<br><b>DL20035 (PA-H)-S</b> | TITLE:<br>2.0 mm Pitch<br>Wire To Board |
| .XX: ± 0.15                              | .X°: ± 2.0°  | DR: Chen Quan Long                       | DATE:19/08/01                           |
| .XXX: ± 0.01                             | .XX°: ± 1.0° | CHKD: Wu Hui                             | DATE:19/08/01                           |
| FINISH:                                  |              | APPD:Ren An De                           | DATE:19/08/01                           |
| DRAWING NO:                              |              |  |   |
|  |              |  | PART NO:                                |
|  |              |  | SCALE: N/A                              |
|  |              |  | PAGE: 2/2                               |
|  |              |  | UNITS: mm                               |
|  |              |  | REV.: A                                 |

| REV. | REVISION DESCRIPTION | DATE | APPD |
|------|----------------------|------|------|
|      |                      |      |      |

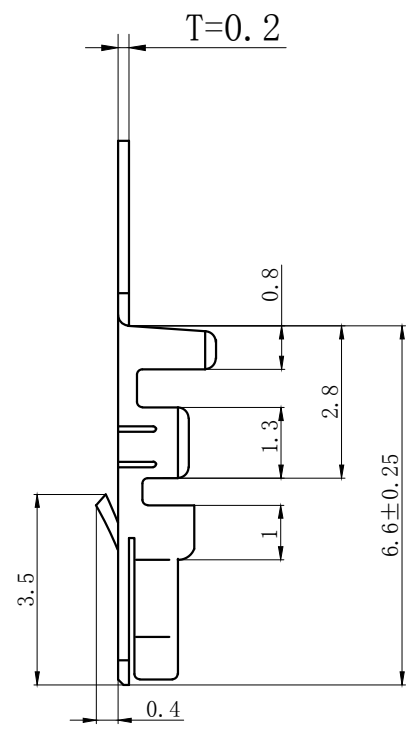
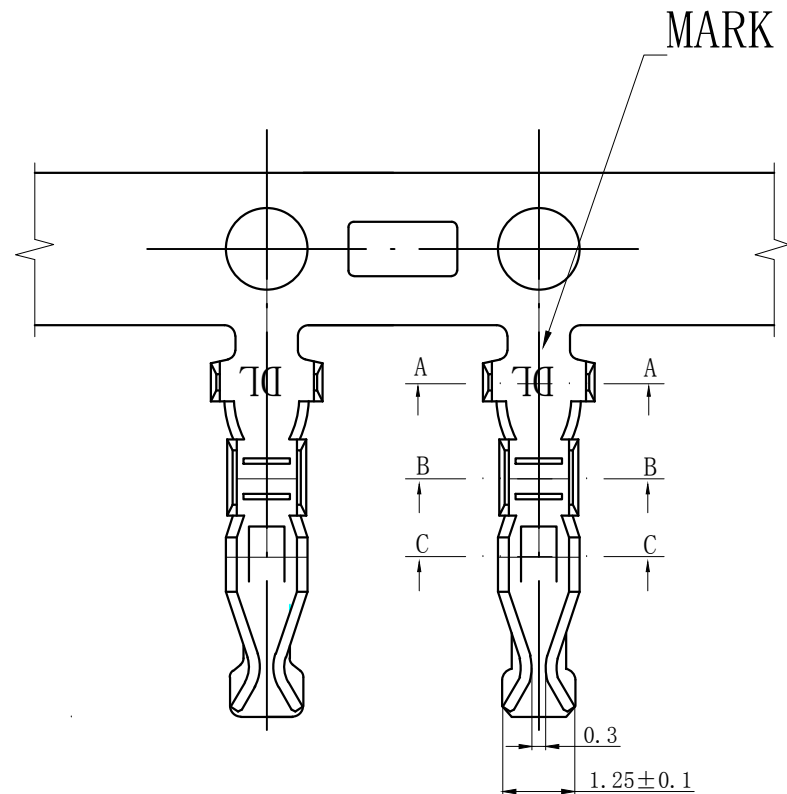

**NOTES**

Used in DL20003-Y Series Housing.  
 Accepts AWG #28~22 Wire Range.  
 0.08~ 0.33 mm<sup>2</sup> .  
 Insulation O.D.=0.9~1.5 mm.  
 Material : Phosphor Bronze .  
 Finish: Tin plated.  
 Thickness: 0.2 mm.

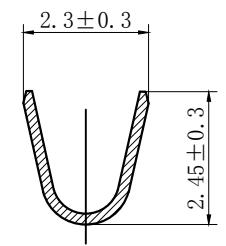

SECTION A-A

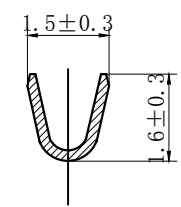

SECTION B-B

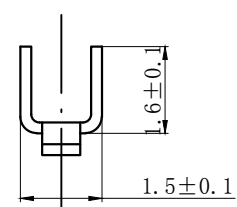

SECTION C-C

| GENERAL TOLERANCES<br>(UNLESS SPECIFIED) |              | ZHE JIANG DELI CONNECTORS CO., LTD     |   |
|--|--------------|--|---|
| .X: ± 0.25                               | X°: ± 3.0°   | PRODUCT NAME:<br><b>DL20003 (PA)-T</b> | TITLE:<br>2.00 mm Pitch<br>Crimp Terminal |
| .XX: ± 0.15                              | .X°: ± 2.0°  | DR: Chen Quan Long                     | DATE: 20.3.31                             |
| .XXX: ± 0.01                             | .XX°: ± 1.0° | CHKD: Wu Hui                           | DATE: 20.3.31                             |
| DRAWING NO:                              |              | APPD: Ren An De                        | DATE: 20.3.31                             |
| FINISH:                                  |              | SCALE: N/A                             | PAGE: 1/1                                 |
| PART NO:                                 |              | UNITS: mm                              | REV.: A                                   |

| REV. | REVISION DESCRIPTION | DATE | APPD |
|------|----------------------|------|------|
|      |                      |      |      |

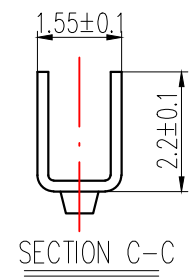
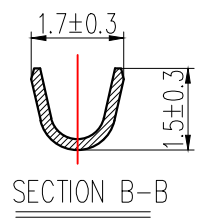
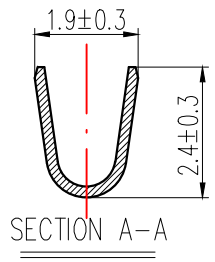
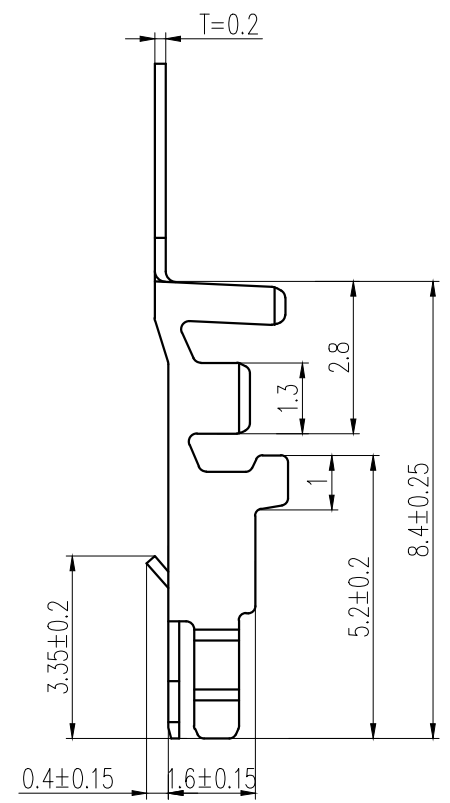
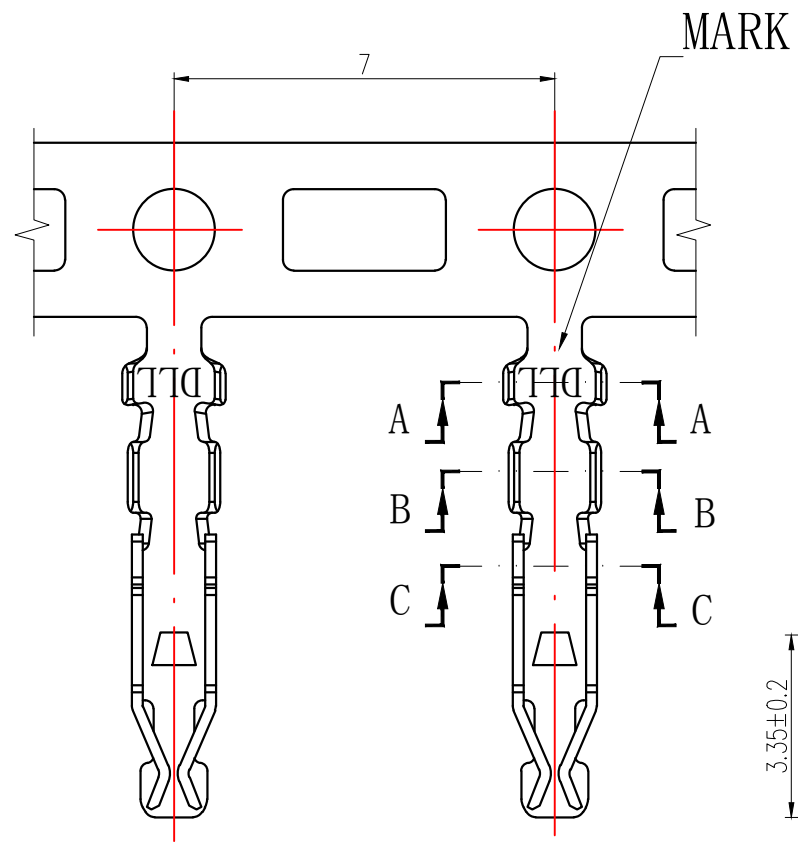

### NOTES

- Used in DL20035-Y Series Housing.
- Accepts AWG #26~22 Wire Range.  
0.13~ 0.33 mm<sup>2</sup> .
- Insulation O.D.=0.9~1.5 mm.
- Material : Phosphor Bronze .
- Finish: Tin plated.
- Thickness: 0.2 mm.

| GENERAL TOLERANCES (UNLESS SPECIFIED) |               | ZHE JIANG DELI CONNECTORS CO., LTD       |  |
|---------------------------------------|---------------|--|--|
| .X: ± 0.25                            | X° : ± 3.0°   | PRODUCT NAME:<br><b>DL20035 (PA-H)-T</b> | TITLE:<br>2.00 mm Pitch Crimp Terminal |
| .XX: ± 0.15                           | .X° : ± 2.0°  | DR:Chen Quan Long                        | DATE:22.3.31                           |
| .XXX: ± 0.01                          | .XX° : ± 1.0° | CHKD:Wu Hui                              | DATE:22.3.31                           |
| DRAWING NO:                           |               | APPD:Ren An De                           | DATE:22.3.31                           |
| FINISH:                               |               | SCALE: N/A                               | PAGE: 1/1                              |
| PART NO:                              |               | UNITS: mm                                | REV.: A                                |

| REV. | REVISION DESCRIPTION | DATE | APPD |
|------|----------------------|------|------|
|      |                      |      |      |

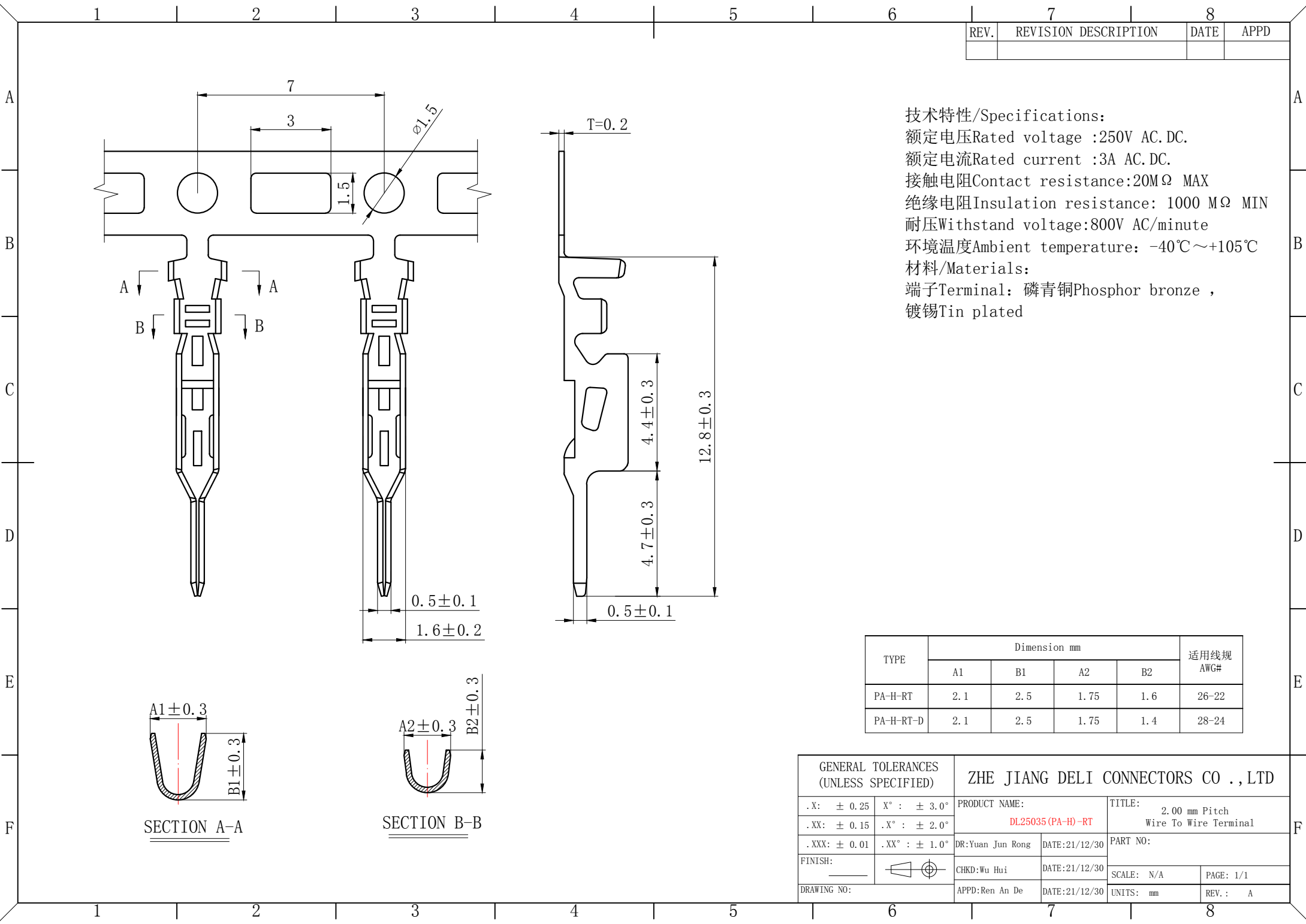

技术特性/Specifications:  
 额定电压Rated voltage :250V AC.DC.  
 额定电流Rated current :3A AC.DC.  
 接触电阻Contact resistance:20MΩ MAX  
 绝缘电阻Insulation resistance: 1000 MΩ MIN  
 耐压Withstand voltage:800V AC/minute  
 环境温度Ambient temperature: -40℃~+105℃  
 材料/Materials:  
 端子Terminal: 磷青铜Phosphor bronze ,  
 镀锡Tin plated

| TYPE      | Dimension mm |     |      |     | 适用线规<br>AWG# |
|-----------|--------------|-----|------|-----|--------------|
|           | A1           | B1  | A2   | B2  |              |
| PA-H-RT   | 2.1          | 2.5 | 1.75 | 1.6 | 26-22        |
| PA-H-RT-D | 2.1          | 2.5 | 1.75 | 1.4 | 28-24        |

|  |              |                                    |               |  |           |
|--|--------------|------------------------------------|---------------|--|-----------|
| GENERAL TOLERANCES<br>(UNLESS SPECIFIED) |              | ZHE JIANG DELI CONNECTORS CO., LTD |               |  |           |
| .X: ± 0.25                               | X°: ± 3.0°   | PRODUCT NAME:<br>DL25035 (PA-H)-RT |               | TITLE:<br>2.00 mm Pitch<br>Wire To Wire Terminal |           |
| .XX: ± 0.15                              | .X°: ± 2.0°  | DR:Yuan Jun Rong                   |               | DATE:21/12/30                                    |           |
| .XXX: ± 0.01                             | .XX°: ± 1.0° | DATE:21/12/30                      |               | PART NO:   |           |
| FINISH:                                  |              | CHKD:Wu Hui                        | DATE:21/12/30 | SCALE: N/A                                       | PAGE: 1/1 |
| DRAWING NO:                              |              | APPD:Ren An De                     | DATE:21/12/30 | UNITS: mm  | REV.: A   |

## X-ON Electronics

Largest Supplier of Electrical and Electronic Components

*Click to view similar products for [Headers & Wire Housings](#) category:*

*Click to view products by [DLL](#) manufacturer:*

Other Similar products are found below :

[0015917161](#) [0022155065](#) [57102-F02-18ULF](#) [58102-G61-06LF](#) [582553-1](#) [01.001.5753.1](#) [0050291907](#) [02.125.8002.8](#) [609-3404](#) [61062-3](#)  
[CSU011177004](#) [622-0430](#) [622-3653LF](#) [63453-116](#) [636-1030](#) [636-1427](#) [636-3427](#) [636-4007](#) [641938-9](#) [65495-038](#) [65692-001LF](#) [65781-018](#)  
[65781-047](#) [65817-010LF](#) [65817-015LF](#) [67095-007LF](#) [67601157](#) [68631-112](#) [68645-018](#) [699319-000](#) [70.362.1628.0](#) [70-4210](#) [70-4226B](#) [70-](#)  
[4853B](#) [71.350.2428.0](#) [733-134](#) [733-162](#) [760-3052](#) [MHR-64-VUAL](#) [80.063.4001.1](#) [800-90-001-10-001000](#) [801-43-002-10-013000](#)  
[801-43-006-10-002000](#) [803-43-024-10-001000](#) [803-93-012-10-001000](#) [8-1437020-4](#) [819-22-004-30-001101](#) [820-22-006-30-001101](#)  
[820-22-008-30-001101](#) [821-22-002-10-001101](#)