

技术特性/Specifications:

额定电压 Rated voltage: 250V AC, DC
额定电流 Rated current: 3A AC, DC
接触电阻 Contact resistance: 20m Ω max
绝缘电阻 Insulation resistance: 1000M Ω min
耐压 Withstand voltage: 800V AC/minute
环境温度 Ambient temperature: -40 $^{\circ}$ C~+105 $^{\circ}$ C
适用线规 Wire range: AWG#28~#22

| REV. | REVISION DESCRIPTION | DATE |
|------|----------------------|------|
| | | |

技术特性/Specifications:

额定电流 Rated current: 3A AC\DC
 额定电压 Rated voltage: 250V AC\DC
 接触电阻 Contact resistance: 20mΩ max
 绝缘电阻 Insulation resistance: 1000MΩ min
 耐压 Withstand voltage: 800V AC/ minute
 环境温度 Ambient temperature: -40℃ to 105℃
 材料/Materials:
 针座Wafer: LCP UL94V-0
 铜针Pin Material: 黄铜Brass / Tin-Plated.

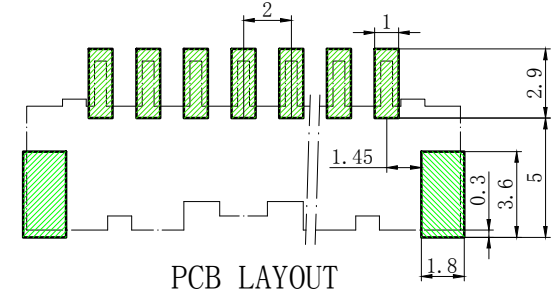
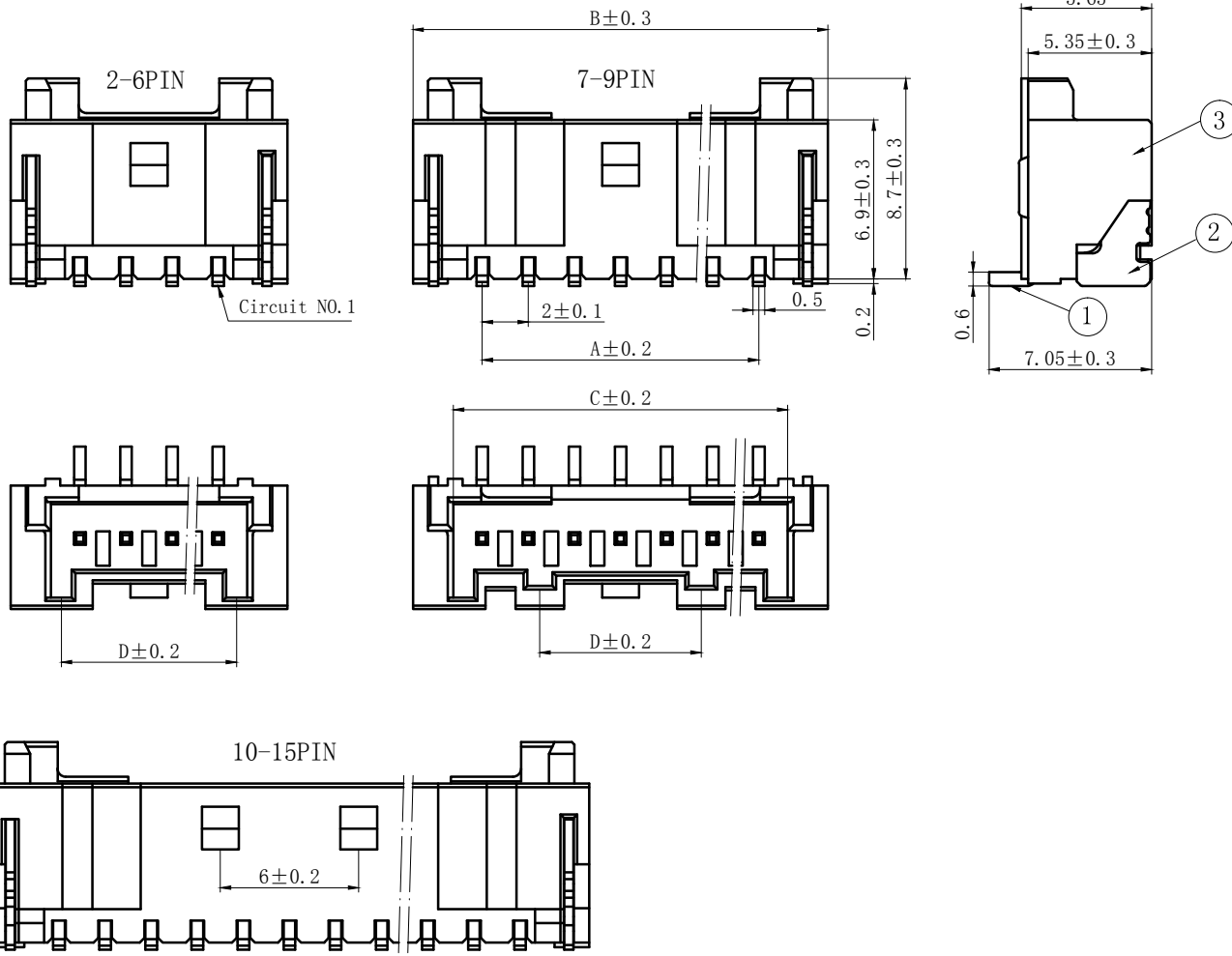

| | | | | | |
|----|----|-----|-----|----|---------|
| 3 | ③ | 基座 | LCP | 1 | UL94V-0 |
| 2 | ② | 焊片 | 黄铜 | 2 | 镀锡 |
| 1 | ① | 接触件 | 黄铜 | N* | 镀锡 |
| 序号 | 图号 | 名称 | 材料 | 数量 | 附件 |

| Circ uits | Product name | Dimension mm | | | | Circ uits | Product name | Dimension mm | | | |
|--------------|-----------------|--------------|-------|-------|------|--------------|-----------------|--------------|-------|-------|-------|
| | | A | B | C | D | | | A | B | C | D |
| 2 | PA-2AB | 2.00 | 8.00 | 4.50 | 3.60 | 10 | PA-10AB | 18.00 | 24.00 | 20.50 | 13.60 |
| 3 | PA-3AB | 4.00 | 10.00 | 6.50 | 5.60 | 11 | PA-11AB | 20.00 | 26.00 | 22.50 | 13.60 |
| 4 | PA-4AB | 6.00 | 12.00 | 8.50 | 7.60 | 12 | PA-12AB | 22.00 | 28.00 | 24.50 | 13.60 |
| 5 | PA-5AB | 8.00 | 14.00 | 10.50 | 7.00 | 13 | PA-13AB | 24.00 | 30.00 | 26.50 | 13.60 |
| 6 | PA-6AB | 10.00 | 16.00 | 12.50 | 7.00 | 14 | PA-14AB | 26.00 | 32.00 | 28.50 | 13.60 |
| 7 | PA-7AB | 12.00 | 18.00 | 14.50 | 7.00 | 15 | PA-15AB | 28.00 | 34.00 | 30.50 | 13.60 |
| 8 | PA-8AB | 14.00 | 20.00 | 16.50 | 7.00 | 16 | PA-16AB | 30.00 | 36.00 | 32.50 | 13.60 |
| 9 | PA-9AB | 16.00 | 22.00 | 18.50 | 7.00 | - | - | - | - | - | - |

| GENERAL TOLERANCES (UNLESS SPECIFIED) | | ZHE JIANG DELI CONNECTORS CO.,LTD | |
|--|---------------|---|--|
| .X: ± 0.25 | X° : ± 3.0° | PRODUCT NAME: DL20003 (PA)-AB | TITLE: 2.00 mm Pitch Wire To Board SMT Wafer |
| .XX: ± 0.15 | .X° : ± 2.0° | DR: Chen Quan Long | DATE: 19/04/03 |
| .XXX: ± 0.01 | .XX° : ± 1.0° | CHKD: Wu Hui | DATE: 19/04/03 |
| FINISH: _____ | | APPD: Ren An De | DATE: 19/04/03 |
| DRAWING NO: | | SCALE: N/A | PAGE: 1/1 |
| | | UNITS: mm | REV.: A |

| REV. | REVISION DESCRIPTION | DATE |
|------|----------------------|------|
| | | |

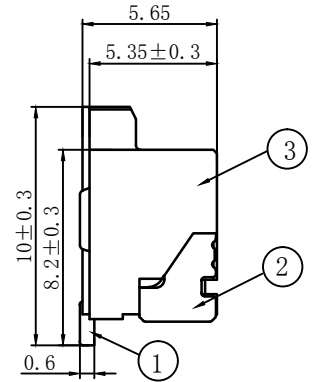
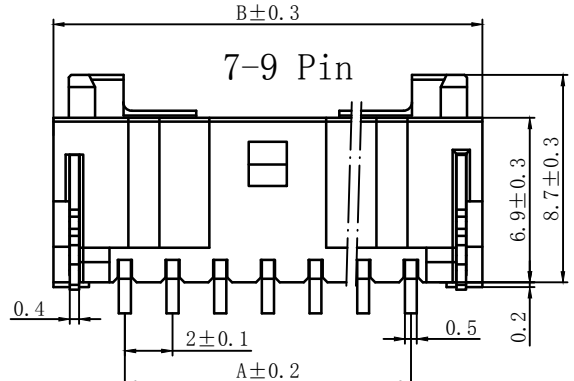
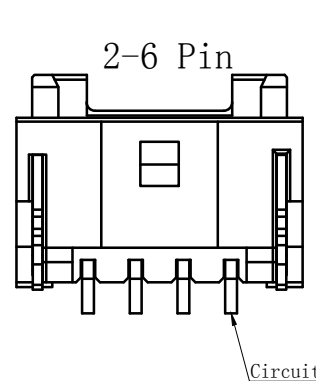

技术特性/Specifications:
 额定电流 Rated current: 3A AC\DC
 额定电压 Rated voltage: 250V AC\DC
 接触电阻 Contact resistance: 20mΩ max
 绝缘电阻 Insulation resistance: 1000MΩ min
 耐压 Withstand voltage: 800V AC/ minute
 环境温度 Ambient temperature: -40℃ to 105℃
 材料/Materials:
 针座Wafer: LCP UL94V-0
 铜针Pin Material : 黄铜Brass / Tin-Plated.

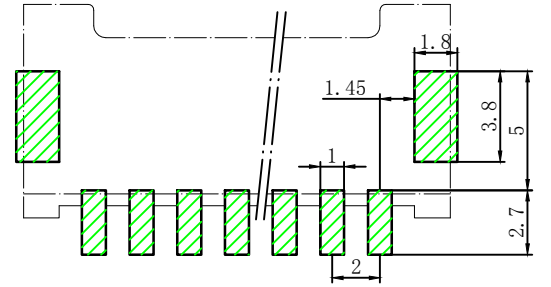
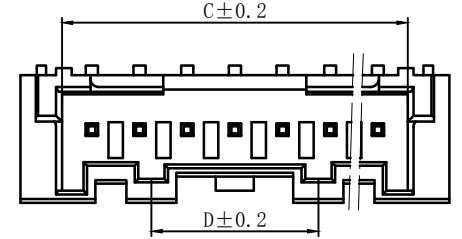
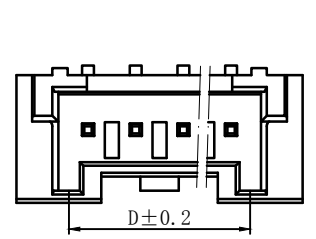

PCB LAYOUT

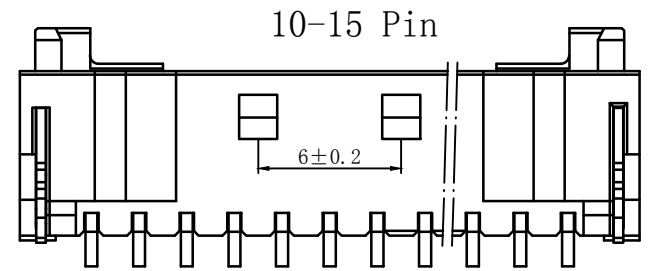

| | | | | | |
|----|----|-----|-----|----|---------|
| 3 | ③ | 基座 | LCP | 1 | UL94V-0 |
| 2 | ② | 焊片 | 黄铜 | 2 | 镀锡 |
| 1 | ① | 接触件 | 黄铜 | N* | 镀锡 |
| 序号 | 图号 | 名称 | 材料 | 数量 | 附件 |

| Circuits | Product name | Dimension mm | | | | Circuits | Product name | Dimension mm | | | |
|----------|--------------|--------------|-------|-------|------|----------|--------------|--------------|-------|-------|-------|
| | | A | B | C | D | | | A | B | C | D |
| 2 | PA-2AWB | 2.00 | 8.00 | 4.50 | 3.60 | 10 | PA-10AWB | 18.00 | 24.00 | 20.50 | 13.60 |
| 3 | PA-3AWB | 4.00 | 10.00 | 6.50 | 5.60 | 11 | PA-11AWB | 20.00 | 26.00 | 22.50 | 13.60 |
| 4 | PA-4AWB | 6.00 | 12.00 | 8.50 | 7.60 | 12 | PA-12AWB | 22.00 | 28.00 | 24.50 | 13.60 |
| 5 | PA-5AWB | 8.00 | 14.00 | 10.50 | 7.00 | 13 | PA-13AWB | 24.00 | 30.00 | 26.50 | 13.60 |
| 6 | PA-6AWB | 10.00 | 16.00 | 12.50 | 7.00 | 14 | PA-14AWB | 26.00 | 32.00 | 28.50 | 13.60 |
| 7 | PA-7AWB | 12.00 | 18.00 | 14.50 | 7.00 | 15 | PA-15AWB | 28.00 | 34.00 | 30.50 | 13.60 |
| 8 | PA-8AWB | 14.00 | 20.00 | 16.50 | 7.00 | 16 | PA-16AWB | 30.00 | 36.00 | 32.50 | 13.60 |
| 9 | PA-9AWB | 16.00 | 22.00 | 18.50 | 7.00 | - | - | - | - | - | - |

| | | | | | |
|---------------------------------------|--------------|--|----------------|---|------------|
| GENERAL TOLERANCES (UNLESS SPECIFIED) | | ZHE JIANG DELI CONNECTORS CO., LTD | | | |
| .X: ± 0.25 | X°: ± 3.0° | PRODUCT NAME: DL20003 (PA)-AWB | | TITLE: 2.00 mm Pitch Wire To Board SMT Wafer | |
| .XX: ± 0.15 | .X°: ± 2.0° | DR: Chen Quan Long | DATE: 19/04/03 | PART NO: | |
| .XXX: ± 0.01 | .XX°: ± 1.0° | FINISH: | CHKD: Wu Hui | DATE: 19/04/03 | SCALE: N/A |
| DRAWING NO: | | APPD: Ren An De | DATE: 19/04/03 | UNITS: mm | PAGE: 1/1 |
| | | | | REV.: A | |

| REV. | REVISION DESCRIPTION | DATE | APPD |
|------|----------------------|------|------|
| | | | |

NOTES

Available in 02 through 16 Circuits.
 Mates with DL20003-Y Series Housing.
 Material : Nylon UL94V-0 (2) .
 0.50mm Square Pin.
 Pin Material : Brass / Tin-Plated.

2PIN

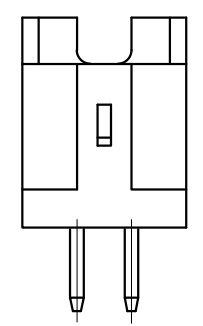

4-9PIN

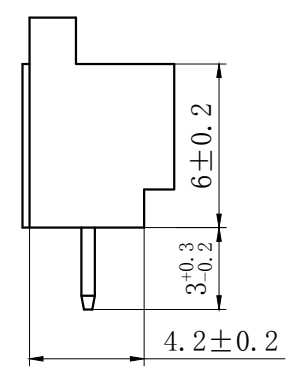
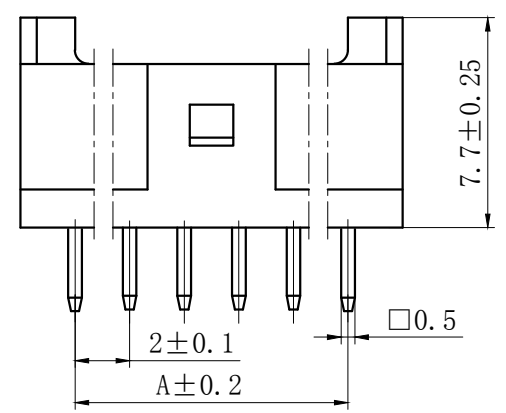

3PIN

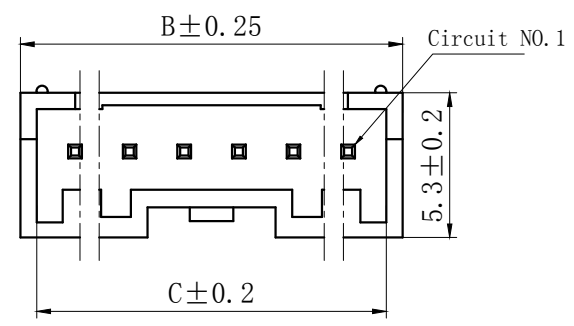
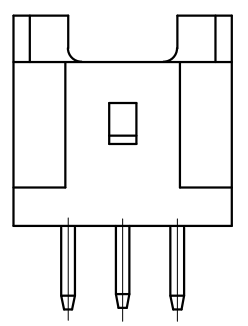

10PIN以上

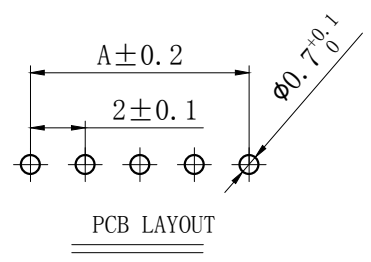
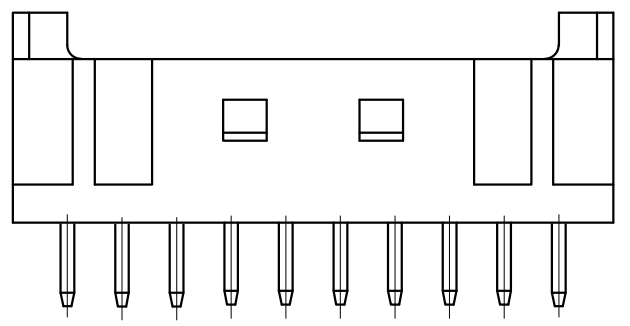

| Circuits | Product name | Dimensino (mm) | | | Circuits | Product name | Dimensino (mm) | | |
|----------|--------------|----------------|-------|-------|----------|--------------|----------------|-------|-------|
| | | A | B | C | | | A | B | C |
| 2 | PA-2A | 2.00 | 6.00 | 4.80 | 10 | PA-10A | 18.00 | 22.00 | 20.80 |
| 3 | PA-3A | 4.00 | 8.00 | 6.80 | 11 | PA-11A | 20.00 | 24.00 | 22.80 |
| 4 | PA-4A | 6.00 | 10.00 | 8.80 | 12 | PA-12A | 22.00 | 26.00 | 24.80 |
| 5 | PA-5A | 8.00 | 12.00 | 10.80 | 13 | PA-13A | 24.00 | 28.00 | 26.80 |
| 6 | PA-6A | 10.00 | 14.00 | 12.80 | 14 | PA-14A | 26.00 | 30.00 | 28.80 |
| 7 | PA-7A | 12.00 | 16.00 | 14.80 | 15 | PA-15A | 28.00 | 32.00 | 30.80 |
| 8 | PA-8A | 14.00 | 18.00 | 16.80 | 16 | PA-16A | 30.00 | 34.00 | 32.80 |
| 9 | PA-9A | 16.00 | 20.00 | 18.80 | - | - | - | - | - |

| | | | |
|---------------------------------------|---------------|-------------------------------------|---|
| GENERAL TOLERANCES (UNLESS SPECIFIED) | | ZHE JIANG DELI CONNECTORS CO ., LTD | |
| .X: ± 0.25 | X° : ± 3.0° | PRODUCT NAME: DL20003 (PA)-A | TITLE: 2.00 mm Pitch Wire To Board Wafer |
| .XX: ± 0.15 | .X° : ± 2.0° | DR: Chen Quan Long | DATE:19/08/01 |
| .XXX: ± 0.01 | .XX° : ± 1.0° | CHKD: Wu Hui | DATE:19/08/01 |
| FINISH: | | APPD:Ren An De | DATE:19/08/01 |
| DRAWING NO: | | | |
| | | SCALE: N/A | PAGE: 1/1 |
| | | UNITS: mm | REV.: A |

| REV. | REVISION DESCRIPTION | DATE | APPD |
|------|----------------------|------|------|
| | | | |

2PIN

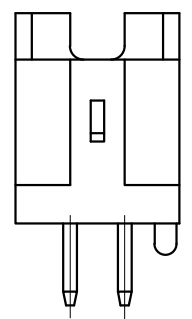

4-9PIN

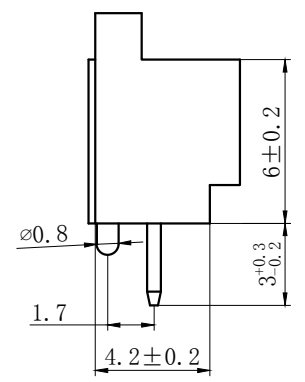
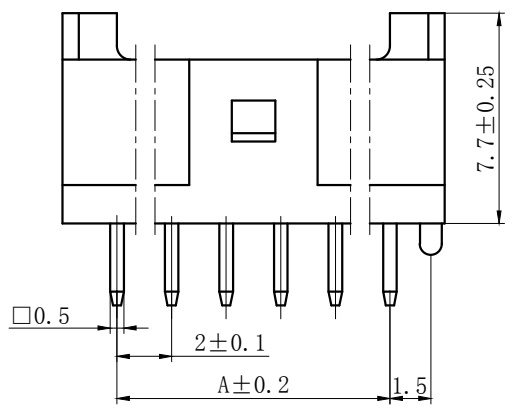

NOTES

Available in 02 through 16 Circuits.
 Mates with DL20003-Y Series Housing.
 Material : Nylon UL94V-0(2).
 0.50mm Square Pin.
 Pin Material : Brass / Tin-Plated.

3PIN

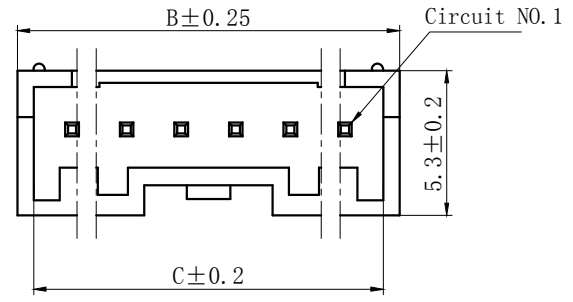
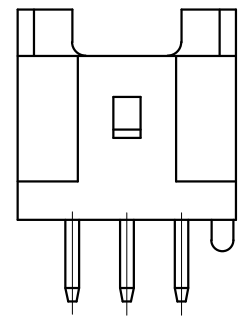

10PIN以上

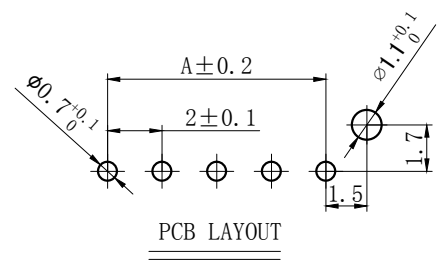
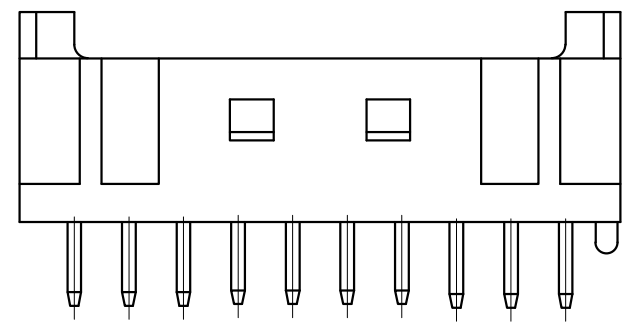

| Circuits | Product name | Dimensino(mm) | | | Circuits | Product name | Dimensino(mm) | | |
|----------|--------------|---------------|-------|-------|----------|--------------|---------------|-------|-------|
| | | A | B | C | | | A | B | C |
| 2 | PA-2AS | 2.00 | 6.00 | 4.80 | 10 | PA-10AS | 18.00 | 22.00 | 20.80 |
| 3 | PA-3AS | 4.00 | 8.00 | 6.80 | 11 | PA-11AS | 20.00 | 24.00 | 22.80 |
| 4 | PA-4AS | 6.00 | 10.00 | 8.80 | 12 | PA-12AS | 22.00 | 26.00 | 24.80 |
| 5 | PA-5AS | 8.00 | 12.00 | 10.80 | 13 | PA-13AS | 24.00 | 28.00 | 26.80 |
| 6 | PA-6AS | 10.00 | 14.00 | 12.80 | 14 | PA-14AS | 26.00 | 30.00 | 28.80 |
| 7 | PA-7AS | 12.00 | 16.00 | 14.80 | 15 | PA-15AS | 28.00 | 32.00 | 30.80 |
| 8 | PA-8AS | 14.00 | 18.00 | 16.80 | 16 | PA-16AS | 30.00 | 34.00 | 32.80 |
| 9 | PA-9AS | 16.00 | 20.00 | 18.80 | - | - | - | - | - |

| | | | |
|---------------------------------------|--------------|------------------------------------|--|
| GENERAL TOLERANCES (UNLESS SPECIFIED) | | ZHE JIANG DELI CONNECTORS CO., LTD | |
| .X: ± 0.25 | .X°: ± 3.0° | PRODUCT NAME: DL20003(PA)-AS | TITLE: 2.00 mm Pitch Wire To Board Wafer |
| .XX: ± 0.15 | .X°: ± 2.0° | DR: Chen Quan Long | DATE:19/08/01 |
| .XXX: ± 0.01 | .XX°: ± 1.0° | CHKD: Zhang Ren Chuan | DATE:19/08/01 |
| FINISH: | | APPD: Ren An De | DATE:19/08/01 |
| DRAWING NO: | | SCALE: N/A | PAGE: 1/1 |
| | | UNITS: mm | REV.: A |

| REV. | 7 | 8 |
|------|----------------------|-----------|
| | REVISION DESCRIPTION | DATE APPD |
| | | |

2PIN

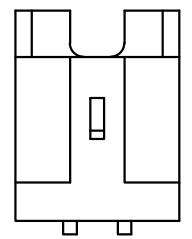

4-9PIN

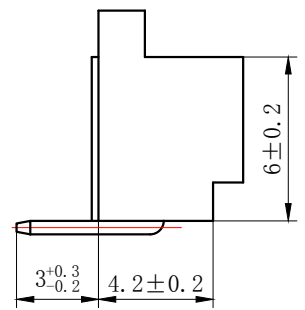
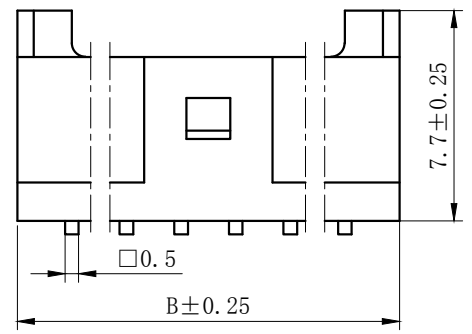

NOTES

Available in 02 through 16 Circuits.
 Mates with DL20003-Y Series Housing.
 Material : Nylon UL94V-0 (2) .
 0.50mm Square Pin.
 Pin Material : Brass / Tin-Plated.

3PIN

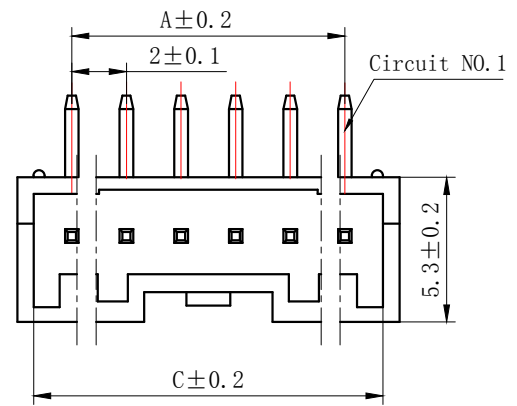
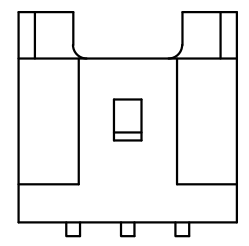

10PIN以上

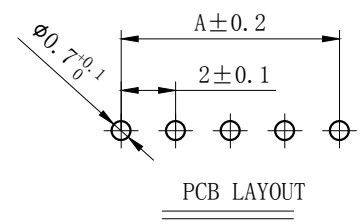
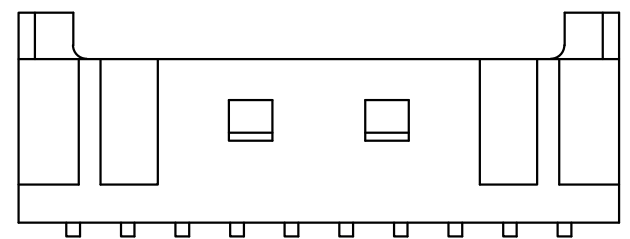

| Circuits | Product name | Dimensino (mm) | | | Circuits | Product name | Dimensino (mm) | | |
|----------|--------------|----------------|-------|-------|----------|--------------|----------------|-------|-------|
| | | A | B | C | | | A | B | C |
| 2 | PA-2AW | 2.00 | 6.00 | 4.80 | 10 | PA-10AW | 18.00 | 22.00 | 20.80 |
| 3 | PA-3AW | 4.00 | 8.00 | 6.80 | 11 | PA-11AW | 20.00 | 24.00 | 22.80 |
| 4 | PA-4AW | 6.00 | 10.00 | 8.80 | 12 | PA-12AW | 22.00 | 26.00 | 24.80 |
| 5 | PA-5AW | 8.00 | 12.00 | 10.80 | 13 | PA-13AW | 24.00 | 28.00 | 26.80 |
| 6 | PA-6AW | 10.00 | 14.00 | 12.80 | 14 | PA-14AW | 26.00 | 30.00 | 28.80 |
| 7 | PA-7AW | 12.00 | 16.00 | 14.80 | 15 | PA-15AW | 28.00 | 32.00 | 30.80 |
| 8 | PA-8AW | 14.00 | 18.00 | 16.80 | 16 | PA-16AW | 30.00 | 34.00 | 32.80 |
| 9 | PA-9AW | 16.00 | 20.00 | 18.80 | - | - | - | - | - |

| | | | |
|---------------------------------------|---------------|-------------------------------------|--|
| GENERAL TOLERANCES (UNLESS SPECIFIED) | | ZHE JIANG DELI CONNECTORS CO ., LTD | |
| .X: ± 0.25 | X° : ± 3.0° | PRODUCT NAME: DL20003 (PA) -AW | TITLE: 2.00 mm Pitch Wire To Board Wafer |
| .XX: ± 0.15 | .X° : ± 2.0° | DR: Chen Quan Long | DATE:19/08/01 |
| .XXX: ± 0.01 | .XX° : ± 1.0° | CHKD:Zhang RenChuan | DATE:19/08/01 |
| FINISH: | | APPD:Ren An De | DATE:19/08/01 |
| DRAWING NO: | | | |
| | | SCALE: N/A | PAGE: 1/1 |
| | | UNITS: mm | REV.: A |

| REV. | REVISION DESCRIPTION | DATE | APPD |
|------|----------------------|------|------|
| | | | |

2PIN

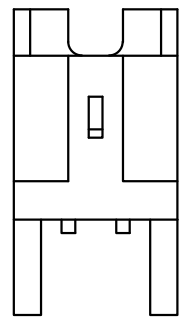

4-9PIN

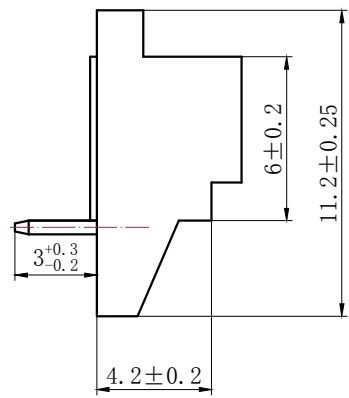
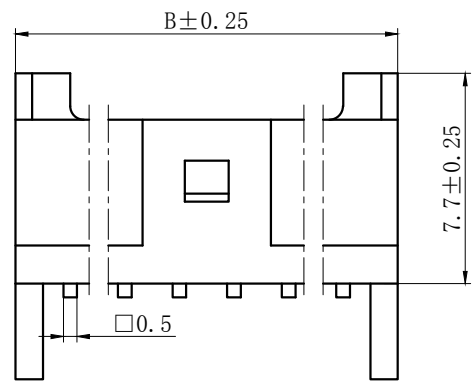

NOTES

Available in 02 through 16 Circuits.
 Mates with DL20003-Y Series Housing.
 Material : Nylon UL94V-0(2).
 0.50mm Square Pin.
 Pin Material : Brass / Tin-Plated.

3PIN

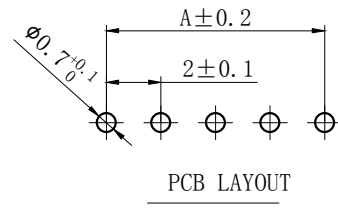
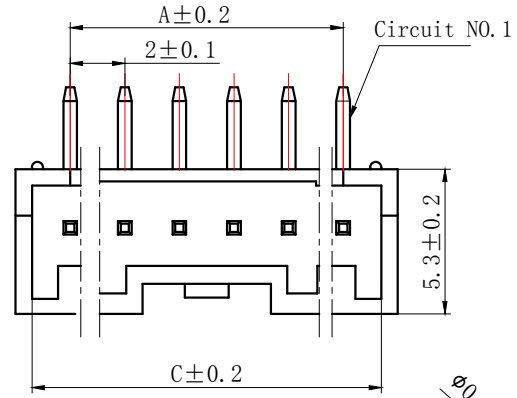
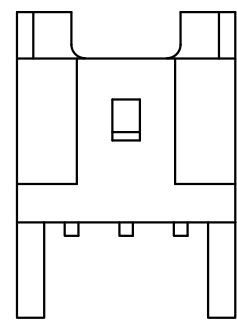

10PIN以上

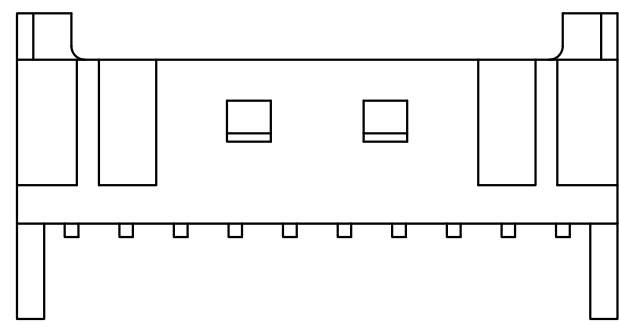

| Circuits | Product name | Dimensino(mm) | | | Circuits | Product name | Dimensino(mm) | | |
|----------|--------------|---------------|-------|-------|----------|--------------|---------------|-------|-------|
| | | A | B | C | | | A | B | C |
| 2 | PA-2AWD | 2.00 | 6.00 | 4.80 | 10 | PA-10AWD | 18.00 | 22.00 | 20.80 |
| 3 | PA-3AWD | 4.00 | 8.00 | 6.80 | 11 | PA-11AWD | 20.00 | 24.00 | 22.80 |
| 4 | PA-4AWD | 6.00 | 10.00 | 8.80 | 12 | PA-12AWD | 22.00 | 26.00 | 24.80 |
| 5 | PA-5AWD | 8.00 | 12.00 | 10.80 | 13 | PA-13AWD | 24.00 | 28.00 | 26.80 |
| 6 | PA-6AWD | 10.00 | 14.00 | 12.80 | 14 | PA-14AWD | 26.00 | 30.00 | 28.80 |
| 7 | PA-7AWD | 12.00 | 16.00 | 14.80 | 15 | PA-15AWD | 28.00 | 32.00 | 30.80 |
| 8 | PA-8AWD | 14.00 | 18.00 | 16.80 | 16 | PA-16AWD | 30.00 | 34.00 | 32.80 |
| 9 | PA-9AWD | 16.00 | 20.00 | 18.80 | - | - | - | - | - |

| | | | |
|---------------------------------------|--------------|------------------------------------|--|
| GENERAL TOLERANCES (UNLESS SPECIFIED) | | ZHE JIANG DELI CONNECTORS CO., LTD | |
| .X: ± 0.25 | X°: ± 3.0° | PRODUCT NAME: | TITLE: 2.00 mm Pitch Wire To Board Wafer |
| .XX: ± 0.15 | .X°: ± 2.0° | DL20003 (PA)-AWD | |
| .XXX: ± 0.01 | .XX°: ± 1.0° | DR: Chen Quan Long | DATE:19/08/01 |
| FINISH: | | CHKD: Wu Hui | DATE:19/08/01 |
| DRAWING NO: | | APPD:Ren An De | DATE:19/08/01 |
| | | SCALE: N/A | PAGE: 1/1 |
| | | UNITS: mm | REV.: A |

| | | |
|----------------------|------|------|
| REV. | 7 | 8 |
| REVISION DESCRIPTION | DATE | APPD |

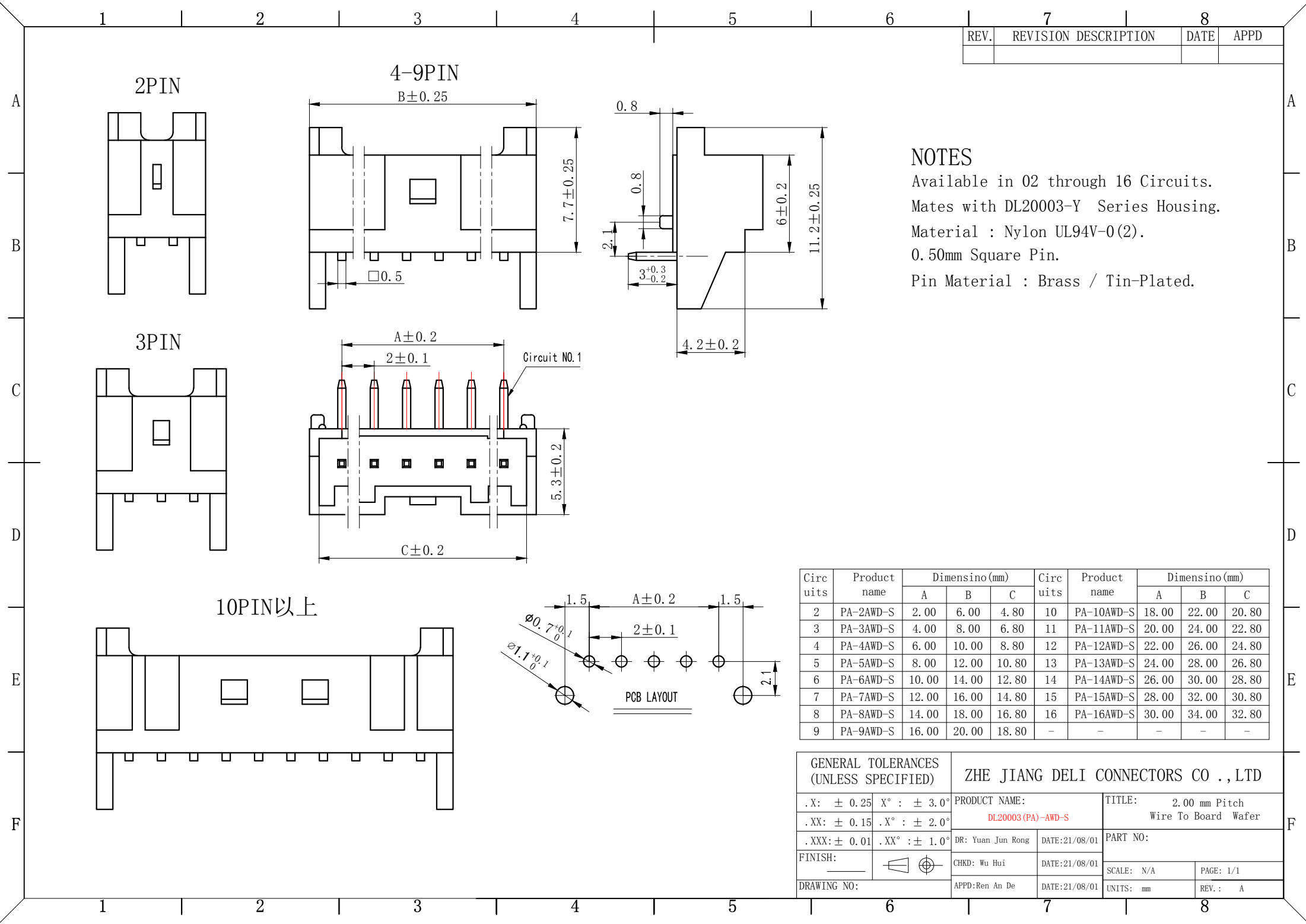

NOTES
 Available in 02 through 16 Circuits.
 Mates with DL20003-Y Series Housing.
 Material : Nylon UL94V-0(2).
 0.50mm Square Pin.
 Pin Material : Brass / Tin-Plated.

| Circuits | Product name | Dimensino(mm) | | | Circuits | Product name | Dimensino(mm) | | |
|----------|--------------|---------------|-------|-------|----------|--------------|---------------|-------|-------|
| | | A | B | C | | | A | B | C |
| 2 | PA-2AWD-S | 2.00 | 6.00 | 4.80 | 10 | PA-10AWD-S | 18.00 | 22.00 | 20.80 |
| 3 | PA-3AWD-S | 4.00 | 8.00 | 6.80 | 11 | PA-11AWD-S | 20.00 | 24.00 | 22.80 |
| 4 | PA-4AWD-S | 6.00 | 10.00 | 8.80 | 12 | PA-12AWD-S | 22.00 | 26.00 | 24.80 |
| 5 | PA-5AWD-S | 8.00 | 12.00 | 10.80 | 13 | PA-13AWD-S | 24.00 | 28.00 | 26.80 |
| 6 | PA-6AWD-S | 10.00 | 14.00 | 12.80 | 14 | PA-14AWD-S | 26.00 | 30.00 | 28.80 |
| 7 | PA-7AWD-S | 12.00 | 16.00 | 14.80 | 15 | PA-15AWD-S | 28.00 | 32.00 | 30.80 |
| 8 | PA-8AWD-S | 14.00 | 18.00 | 16.80 | 16 | PA-16AWD-S | 30.00 | 34.00 | 32.80 |
| 9 | PA-9AWD-S | 16.00 | 20.00 | 18.80 | - | - | - | - | - |

| | | | |
|---------------------------------------|--------------|------------------------------------|--|
| GENERAL TOLERANCES (UNLESS SPECIFIED) | | ZHE JIANG DELI CONNECTORS CO., LTD | |
| .X: ± 0.25 | X°: ± 3.0° | PRODUCT NAME: DL20003(PA)-AWD-S | TITLE: 2.00 mm Pitch Wire To Board Wafer |
| .XX: ± 0.15 | .X°: ± 2.0° | DR: Yuan Jun Rong | DATE:21/08/01 |
| .XXX: ± 0.01 | .XX°: ± 1.0° | CHKD: Wu Hui | DATE:21/08/01 |
| FINISH: | | APPD:Ren An De | DATE:21/08/01 |
| DRAWING NO: | | | |

| | | | | | |
|------|---|----------------------|---|------|------|
| REV. | 7 | REVISION DESCRIPTION | 8 | DATE | APPD |
| | | | | | |

NOTES

Available in 02 through 16 Circuits.
 Mates with DL20035-Y Series Housing.
 Material : Nylon UL94V-0 (2) .
 0.50mm Square Pin.
 Pin Material : Brass / Tin-Plated.

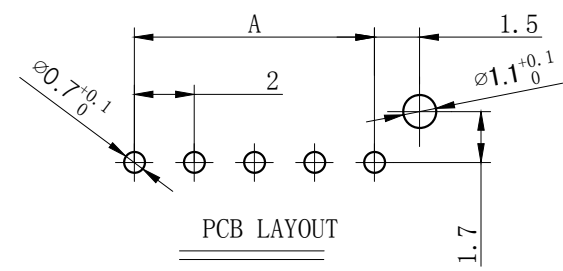
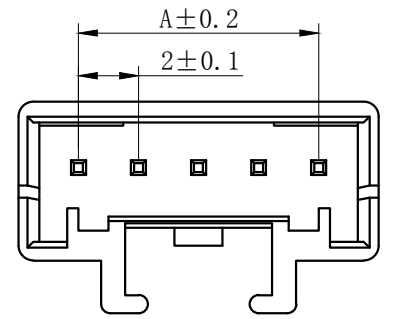
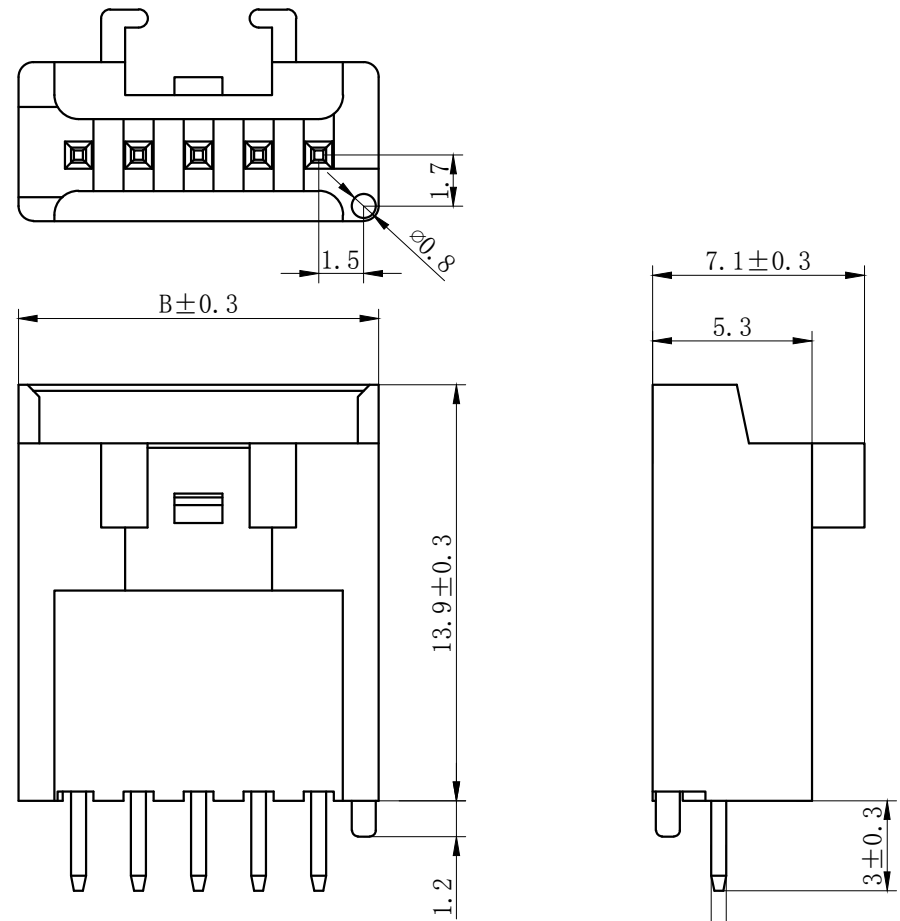

| Circuits | Product name | Dimensino (mm) | |
|----------|--------------|----------------|------|
| | | A | B |
| 2 | PA-H-2AS | 2.0 | 6.0 |
| 3 | PA-H-3AS | 4.0 | 8.0 |
| 4 | PA-H-4AS | 6.0 | 10.0 |
| 5 | PA-H-5AS | 8.0 | 12.0 |
| 6 | PA-H-6AS | 10.0 | 14.0 |
| 7 | PA-H-7AS | 12.0 | 16.0 |
| 8 | PA-H-8AS | 14.0 | 18.0 |
| 9 | PA-H-9AS | 16.0 | 20.0 |
| 10 | PA-H-10AS | 18.0 | 22.0 |
| 11 | PA-H-11AS | 20.0 | 24.0 |
| 12 | PA-H-12AS | 22.0 | 26.0 |
| 13 | PA-H-13AS | 24.0 | 28.0 |
| 14 | PA-H-14AS | 26.0 | 30.0 |
| 15 | PA-H-15AS | 28.0 | 32.0 |
| 16 | PA-H-16AS | 30.0 | 34.0 |

| | | | |
|---------------------------------------|---------------|-------------------------------------|--|
| GENERAL TOLERANCES (UNLESS SPECIFIED) | | ZHE JIANG DELI CONNECTORS CO ., LTD | |
| .X: ± 0.25 | X° : ± 3.0° | PRODUCT NAME: | TITLE: 2.00 mm Pitch Wire To Board Wafer |
| .XX: ± 0.15 | .X° : ± 2.0° | DL20035 (PA-H)-AS | |
| .XXX: ± 0.01 | .XX° : ± 1.0° | DR: Zhang Wen Jing | DATE:09/08/01 |
| FINISH: | | CHKD: Wu Hui | DATE:09/08/01 |
| DRAWING NO: | | APPD:Ren An De | DATE:09/08/01 |
| | | SCALE: N/A | PAGE: 1/1 |
| | | UNITS: mm | REV.: A |

| REV. | REVISION DESCRIPTION | DATE | APPD |
|------|----------------------|------|------|
| | | | |

NOTES

Available in 02 through 05 Circuits.
 Mates with DL20035-Y Series Housing.
 Material : Nylon UL94V-0(2).
 Accepts DL20035-RT Crimp Terminal.

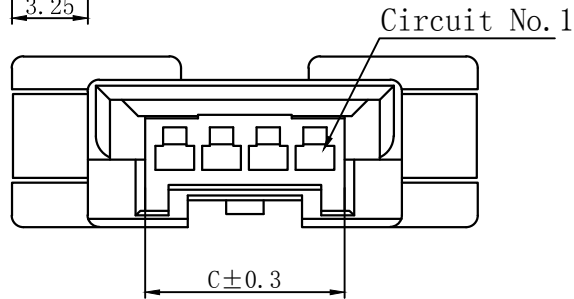
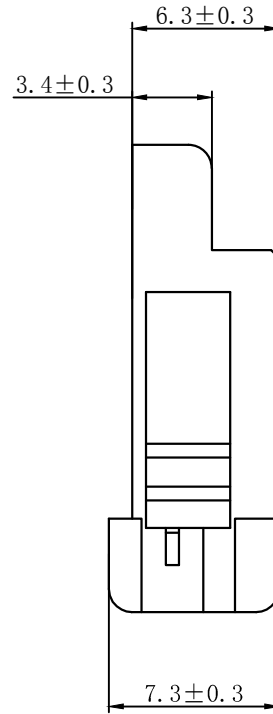
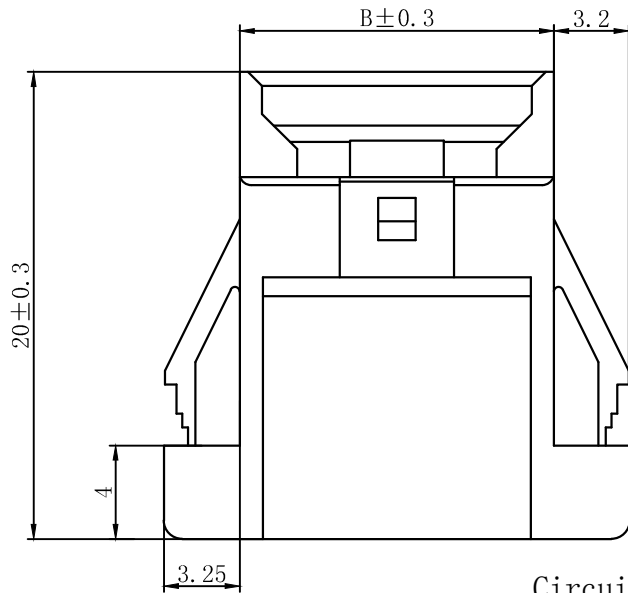
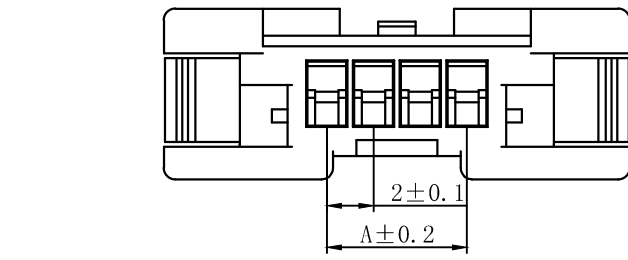
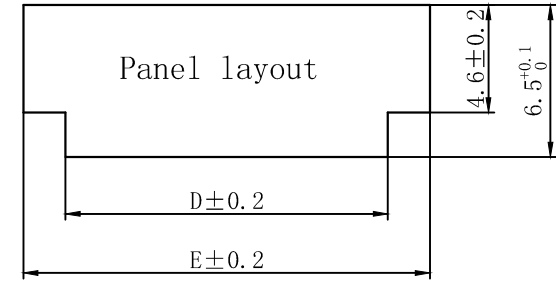

| Circuits | Product name | Dimension mm | | | | |
|----------|--------------|--------------|-------|-------|-------|-------|
| | | A | B | C | D | E |
| 2 | PA-H-2R | 2.00 | 9.40 | 4.55 | 9.80 | 13.40 |
| 3 | PA-H-3R | 4.00 | 11.40 | 6.55 | 11.80 | 15.40 |
| 4 | PA-H-4R | 6.00 | 13.40 | 8.55 | 13.80 | 17.40 |
| 5 | PA-H-5R | 8.00 | 15.40 | 10.55 | 15.80 | 19.40 |

| | | | | | |
|--|-----------------------|--|----------------|--|-----------|
| GENERAL TOLERANCES (UNLESS SPECIFIED) | | ZHE JIANG DELI CONNECTORS CO., LTD | | | |
| .X: ± 0.25 | X°: $\pm 3.0^\circ$ | PRODUCT NAME: DL20035 (PA-H)-R | | TITLE: 2.00 mm Pitch Wire To Wire Housing | |
| .XX: ± 0.15 | .X°: $\pm 2.0^\circ$ | DR: Chen Quan Long | DATE: 22/10/12 | PART NO: | |
| .XXX: ± 0.01 | .XX°: $\pm 1.0^\circ$ | CHKD: Wu Hui | DATE: 22/10/12 | SCALE: N/A | PAGE: 1/1 |
| DRAWING NO: | | APPD: Ren An De | DATE: 22/10/12 | UNITS: mm | REV.: A |

| | | | |
|------|----------------------|------|------|
| REV. | REVISION DESCRIPTION | DATE | APPD |
| | | | |

NOTES

Available in 06 through 15 Circuits.
 Mates with DL20035-Y Series Housing.
 Material : Nylon UL94V-0(2).
 Accepts DL20035-RT Crimp Terminal.

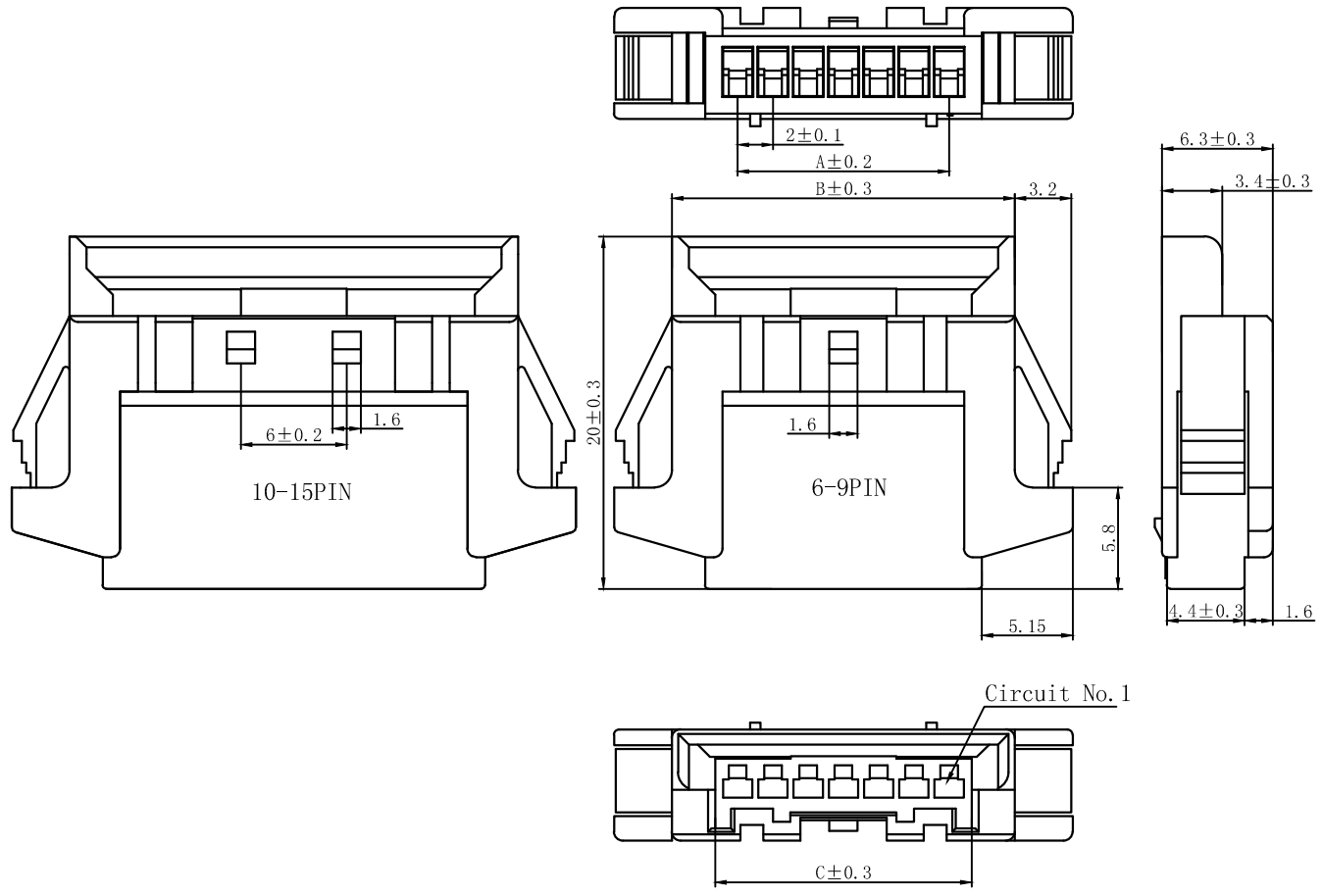

| Circuits | Product name | Dimension mm | | | | |
|----------|--------------|--------------|-------|-------|-------|-------|
| | | A | B | C | D | E |
| 6 | PA-H-6R | 10.00 | 17.40 | 12.55 | 19.80 | 21.40 |
| 7 | PA-H-7R | 12.00 | 19.40 | 14.55 | 21.80 | 23.40 |
| 8 | PA-H-8R | 14.00 | 21.40 | 16.55 | 23.80 | 25.40 |
| 9 | PA-H-9R | 16.00 | 23.40 | 18.55 | 25.80 | 27.40 |
| 10 | PA-H-10R | 18.00 | 25.40 | 20.55 | 27.80 | 29.40 |
| 11 | PA-H-11R | 20.00 | 27.40 | 22.55 | 29.80 | 31.40 |
| 12 | PA-H-12R | 22.00 | 29.40 | 24.55 | 31.80 | 33.40 |
| 13 | PA-H-13R | 24.00 | 31.40 | 26.55 | 33.80 | 35.40 |
| 14 | PA-H-14R | 26.00 | 33.40 | 28.55 | 35.80 | 37.40 |
| 15 | PA-H-15R | 28.00 | 35.40 | 30.55 | 37.80 | 39.40 |

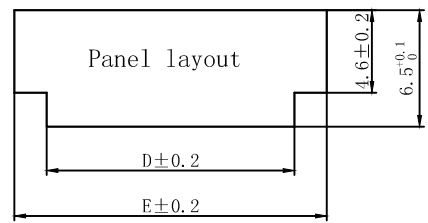

| | | | |
|---------------------------------------|-----------------------|------------------------------------|--|
| GENERAL TOLERANCES (UNLESS SPECIFIED) | | ZHE JIANG DELI CONNECTORS CO., LTD | |
| .X: ± 0.25 | X°: $\pm 3.0^\circ$ | PRODUCT NAME: DL20035 (PA-H)-R | TITLE: 2.00 mm Pitch Wire To Wire Housing |
| .XX: ± 0.15 | .X°: $\pm 2.0^\circ$ | DR: Chen Quan Long | DATE: 22/10/12 |
| .XXX: ± 0.01 | .XX°: $\pm 1.0^\circ$ | CHKD: Wu Hui | DATE: 22/10/12 |
| DRAWING NO: | | APPD: Ren An De | DATE: 22/10/12 |
| FINISH: | | PART NO: | |
| | | SCALE: N/A | PAGE: 1/1 |
| | | UNITS: mm | REV.: A |

| REV. | REVISION DESCRIPTION | DATE | APPD |
|------|----------------------|------|------|
| | | | |

NOTES

Available in 02 through 05 Circuits.
 Mates with DL20035-Y Series Housing.
 Material : Nylon UL94V-0(2).
 Accepts DL20035-RT Crimp Terminal.

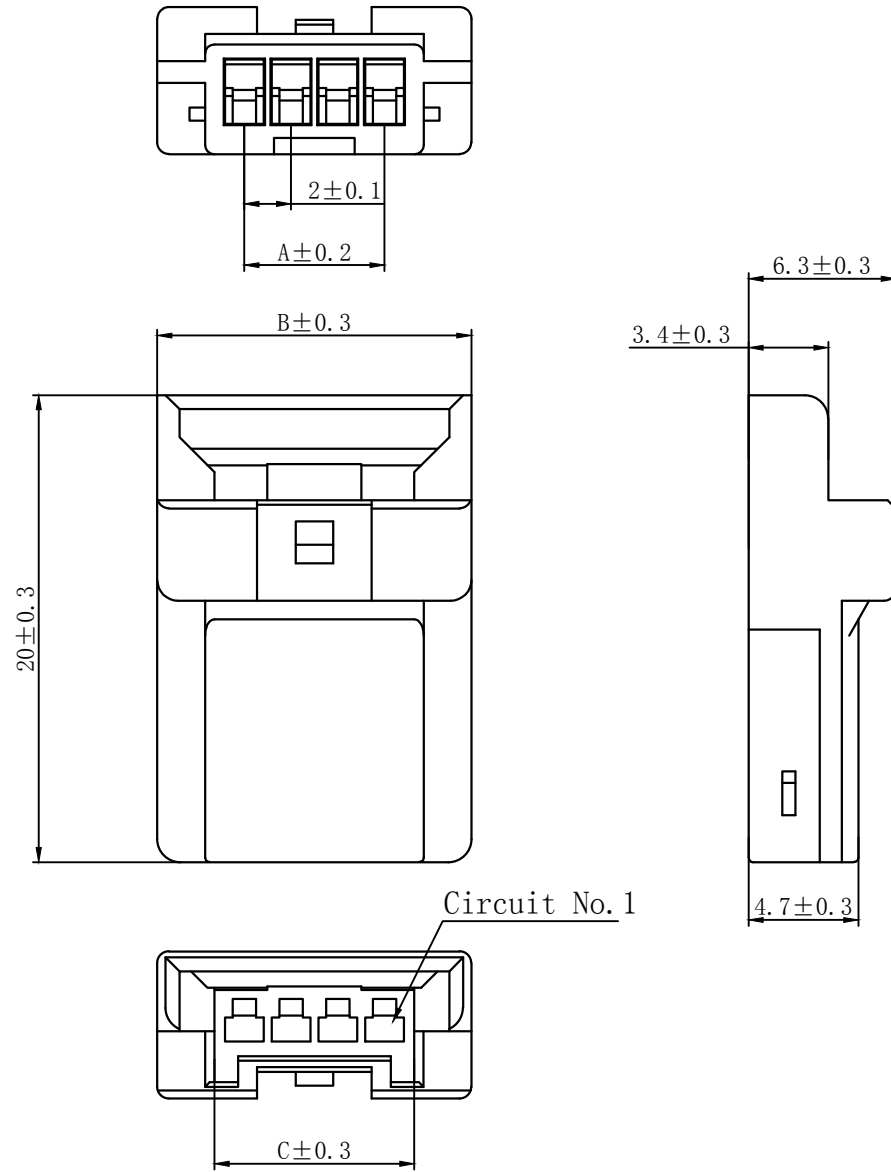

| Circuits | Product name | Dimension mm | | |
|----------|--------------|--------------|-------|-------|
| | | A | B | C |
| 2 | PA-H-2RF | 2.00 | 9.40 | 4.55 |
| 3 | PA-H-3RF | 4.00 | 11.40 | 6.55 |
| 4 | PA-H-4RF | 6.00 | 13.40 | 8.55 |
| 5 | PA-H-5RF | 8.00 | 15.40 | 10.55 |

| | | | |
|--|-----------------------|------------------------------------|---|
| GENERAL TOLERANCES (UNLESS SPECIFIED) | | ZHE JIANG DELI CONNECTORS CO., LTD | |
| .X: ± 0.25 | X°: $\pm 3.0^\circ$ | PRODUCT NAME: DL20035(PA-H)-RF | TITLE: 2.00 mm Pitch Wire To Wire Housing |
| .XX: ± 0.15 | .X°: $\pm 2.0^\circ$ | DR: Chen Quan Long | DATE:22/10/12 |
| .XXX: ± 0.01 | .XX°: $\pm 1.0^\circ$ | CHKD: Wu Hui | DATE:22/10/12 |
| FINISH: | | APPD:Ren An De | DATE:22/10/12 |
| DRAWING NO: | | | |
| | | SCALE: N/A | PAGE: 1/1 |
| | | UNITS: mm | REV.: A |

| | | | |
|------|----------------------|------|------|
| REV. | REVISION DESCRIPTION | DATE | APPD |
| | | | |

NOTES

Available in 06 through 15 Circuits.
 Mates with DL20035-Y Series Housing.
 Material : Nylon UL94V-0(2).
 Accepts DL20035-RT Crimp Terminal.

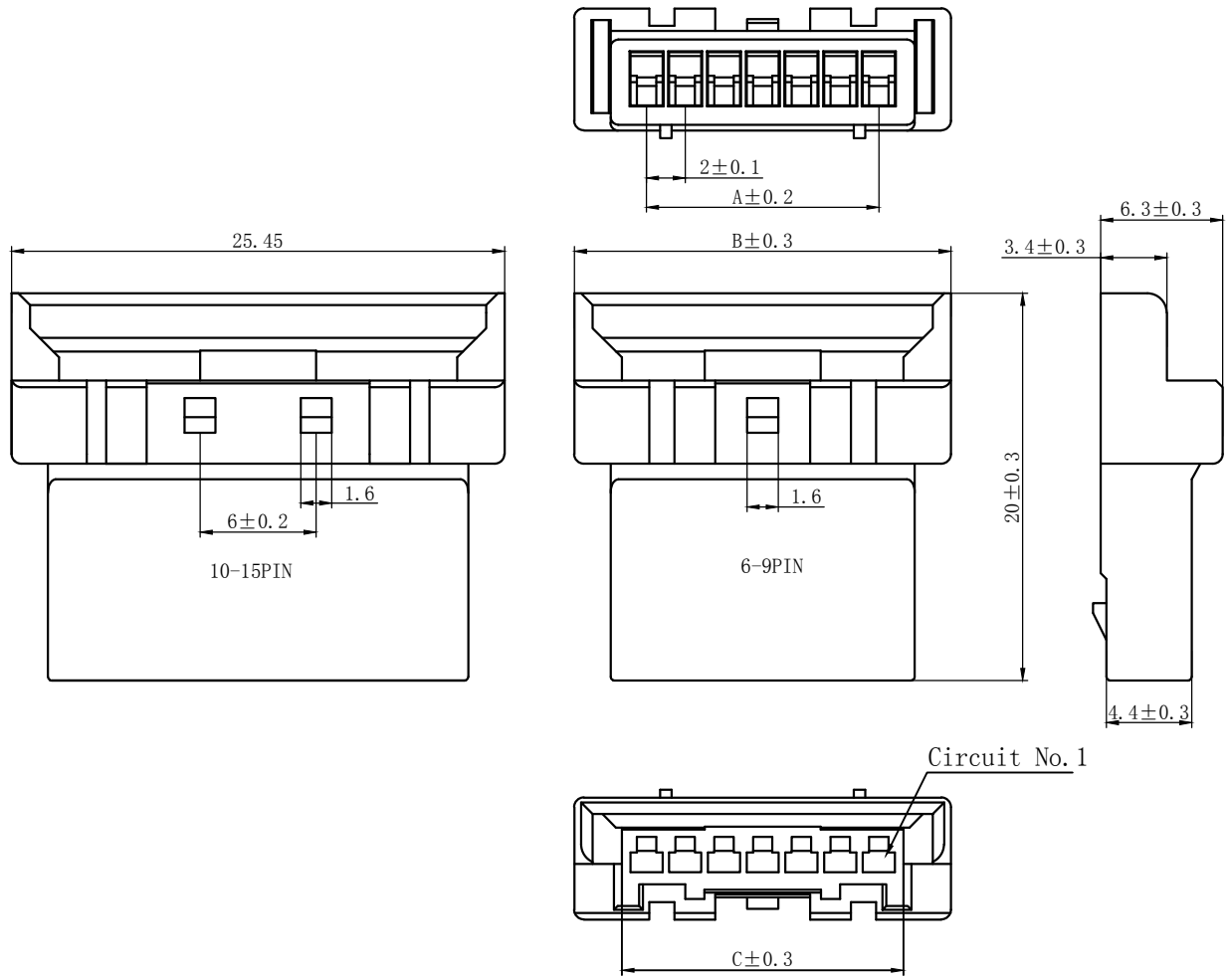

| Circuits | Product name | Dimension mm | | |
|----------|--------------|--------------|-------|-------|
| | | A | B | C |
| 6 | PA-H-6RF | 10.00 | 17.40 | 12.55 |
| 7 | PA-H-7RF | 12.00 | 19.40 | 14.55 |
| 8 | PA-H-8RF | 14.00 | 21.40 | 16.55 |
| 9 | PA-H-9RF | 16.00 | 23.40 | 18.55 |
| 10 | PA-H-10RF | 18.00 | 25.40 | 20.55 |
| 11 | PA-H-11RF | 20.00 | 27.40 | 22.55 |
| 12 | PA-H-12RF | 22.00 | 29.40 | 24.55 |
| 13 | PA-H-13RF | 24.00 | 31.40 | 26.55 |
| 14 | PA-H-14RF | 26.00 | 33.40 | 28.55 |
| 15 | PA-H-15RF | 28.00 | 35.40 | 30.55 |

| | | | |
|--|--------------|------------------------------------|---|
| GENERAL TOLERANCES (UNLESS SPECIFIED) | | ZHE JIANG DELI CONNECTORS CO., LTD | |
| .X: ± 0.25 | X°: ± 3.0° | PRODUCT NAME: DL20035 (PA-H)-RF | TITLE: 2.00 mm Pitch Wire To Wire Housing |
| .XX: ± 0.15 | .X°: ± 2.0° | DR: Chen Quan Long | DATE:22/10/12 |
| .XXX: ± 0.01 | .XX°: ± 1.0° | CHKD: Wu Hui | DATE:22/10/12 |
| FINISH: | | APPD: Ren An De | DATE:22/10/12 |
| DRAWING NO: | | | |

A
B
C
D
E
F

A
B
C
D
E
F

1 2 3 4 5 6 7 8

1 2 3 4 5 6 7 8

| REV. | 7 | 8 |
|----------------------|------|------|
| REVISION DESCRIPTION | DATE | APPD |
| | | |

A
B
C
D
E
F

A
B
C
D
E
F

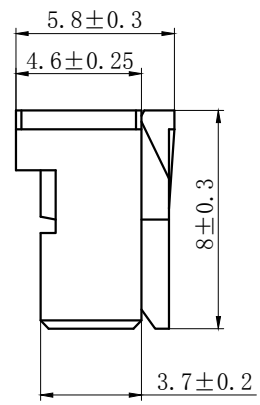
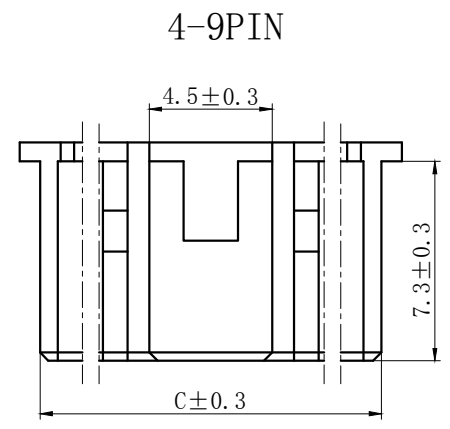
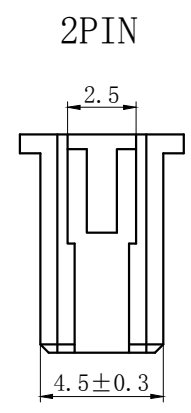

NOTES

Available in 02 through 16 Circuits.
Match with DL20003 series housing.
Material : Nylon UL94V-0 (2) .
Accepts DL20003-T Crimp Terminal.

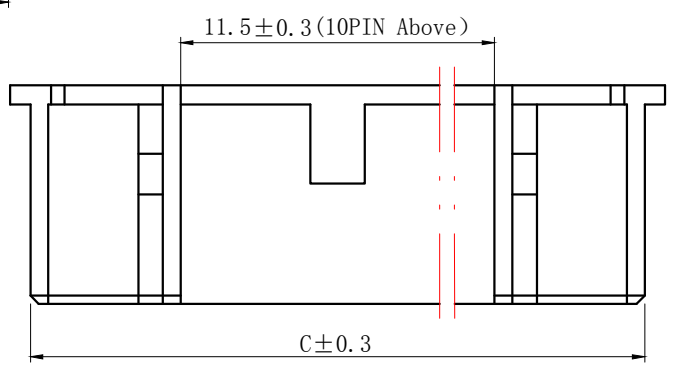
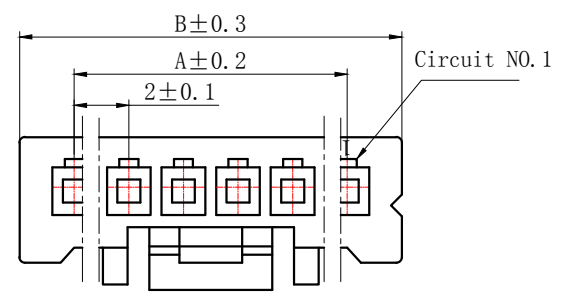
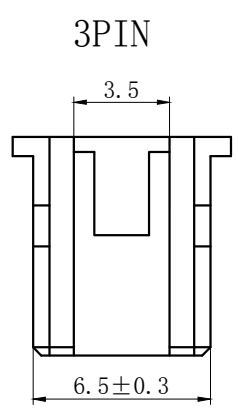

| Circuits | PRODUCT NAME | Dimension mm | | | Circuits | PRODUCT NAME | Dimension mm | | |
|----------|--------------|--------------|------|------|----------|--------------|--------------|------|------|
| | | A | B | C | | | A | B | C |
| 2 | PA-2Y | 2.0 | 6.0 | 4.5 | 10 | PA-10Y | 18.0 | 22.0 | 20.5 |
| 3 | PA-3Y | 4.0 | 8.0 | 6.5 | 11 | PA-11Y | 20.0 | 24.0 | 22.5 |
| 4 | PA-4Y | 6.0 | 10.0 | 8.5 | 12 | PA-12Y | 22.0 | 26.0 | 24.5 |
| 5 | PA-5Y | 8.0 | 12.0 | 10.5 | 13 | PA-13Y | 24.0 | 28.0 | 26.5 |
| 6 | PA-6Y | 10.0 | 14.0 | 12.5 | 14 | PA-14Y | 26.0 | 30.0 | 28.5 |
| 7 | PA-7Y | 12.0 | 16.0 | 14.5 | 15 | PA-15Y | 28.0 | 32.0 | 30.5 |
| 8 | PA-8Y | 14.0 | 18.0 | 16.5 | 16 | PA-16Y | 30.0 | 34.0 | 32.5 |
| 9 | PA-9Y | 16.0 | 20.0 | 18.5 | | | | | |

| | | | |
|---------------------------------------|---------------|-------------------------------------|---------------------------------|
| GENERAL TOLERANCES (UNLESS SPECIFIED) | | ZHE JIANG DELI CONNECTORS CO ., LTD | |
| .X: ± 0.25 | X° : ± 3.0° | PRODUCT NAME: DL20003 (PA)-Y | TITLE: 2.00 mm Pitch Housing |
| .XX: ± 0.15 | .X° : ± 2.0° | DR: Chen Quan Long | DATE:19/08/01 |
| .XXX: ± 0.01 | .XX° : ± 1.0° | CHKD:Wu Hui | DATE:19/08/01 |
| FINISH: | | APPD:Ren An De | DATE:19/08/01 |
| DRAWING NO: | | | |
| | | SCALE: N/A | PAGE: 1/1 |
| | | UNITS: mm | REV.: A |

1 2 3 4 5 6 7 8

| REV. | REVISION DESCRIPTION | DATE | APPD |
|------|----------------------|------|------|
| | | | |

NOTES

Available in 02 through 16 Circuits.
 Match with DL20035-AS series Wafer.
 Material : Nylon UL94V-0 (2) .
 Accepts DL20035-T Crimp Terminal.

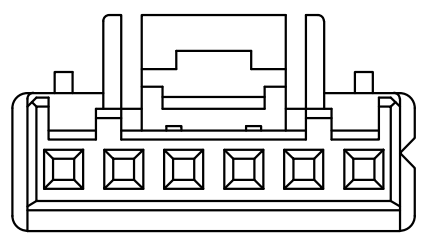

A

A

B

B

C

C

D

D

E

E

F

F

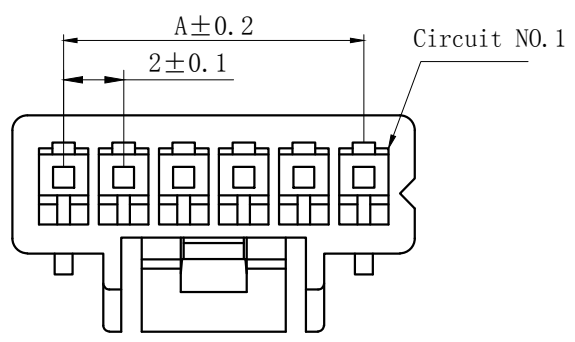
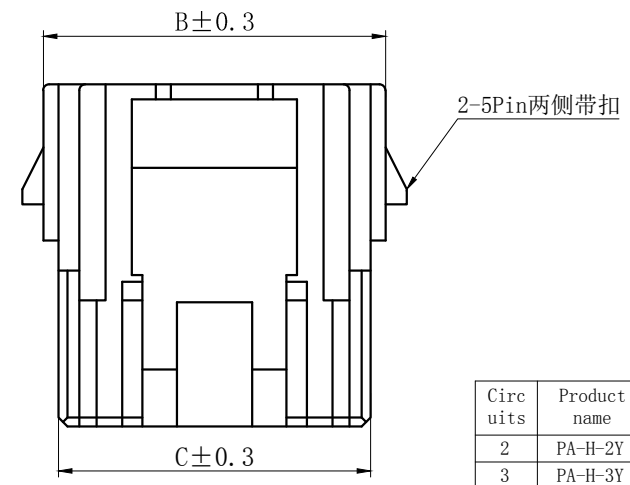
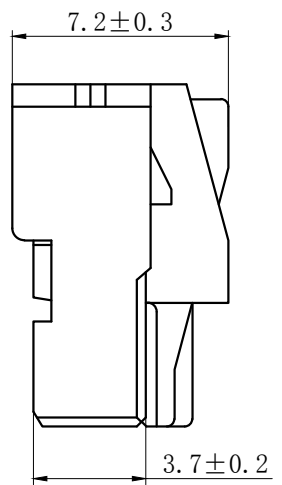
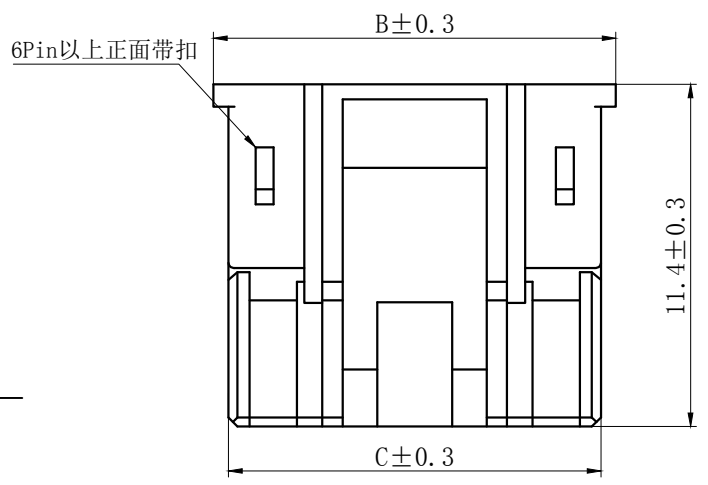

| Circuits | Product name | Dimensino (mm) | | |
|----------|--------------|----------------|------|------|
| | | A | B | C |
| 2 | PA-H-2Y | 2.0 | 5.4 | 4.5 |
| 3 | PA-H-3Y | 4.0 | 7.4 | 6.5 |
| 4 | PA-H-4Y | 6.0 | 9.4 | 8.5 |
| 5 | PA-H-5Y | 8.0 | 11.4 | 10.5 |
| 6 | PA-H-6Y | 10.0 | 13.4 | 12.5 |
| 7 | PA-H-7Y | 12.0 | 15.4 | 14.5 |
| 8 | PA-H-8Y | 14.0 | 17.4 | 16.5 |
| 9 | PA-H-9Y | 16.0 | 19.4 | 18.5 |
| 10 | PA-H-10Y | 18.0 | 21.4 | 20.5 |
| 11 | PA-H-11Y | 20.0 | 23.4 | 22.5 |
| 12 | PA-H-12Y | 22.0 | 25.4 | 24.5 |
| 13 | PA-H-13Y | 24.0 | 27.4 | 26.5 |
| 14 | PA-H-14Y | 26.0 | 29.4 | 28.5 |
| 15 | PA-H-15Y | 28.0 | 31.4 | 30.5 |
| 16 | PA-H-16Y | 30.0 | 33.4 | 32.5 |

| | | | |
|---------------------------------------|---------------|------------------------------------|-----------------------|
| GENERAL TOLERANCES (UNLESS SPECIFIED) | | ZHE JIANG DELI CONNECTORS CO., LTD | |
| .X: ± 0.25 | X° : ± 3.0° | PRODUCT NAME: | TITLE: |
| .XX: ± 0.15 | .X° : ± 2.0° | DL20035 (PA-H)-Y | 2.00 mm Pitch Housing |
| .XXX: ± 0.01 | .XX° : ± 1.0° | DR: Chen Quan Long | DATE:22/08/01 |
| FINISH: | | CHKD:Wu Hui | DATE:22/08/01 |
| DRAWING NO: | | APPD:Ren An De | DATE:22/08/01 |
| | | SCALE: N/A | PAGE: 1/1 |
| | | UNITS: mm | REV.: A |

| REV. | REVISION DESCRIPTION | DATE | APPD |
|------|----------------------|------|------|
| | | | |

NOTES

Available in 02 through 05 Circuits.
 Mates with DL20035-Y Series Housing.
 Material : Nylon UL94V-0(2).
 Green Material RoHS Compliant.

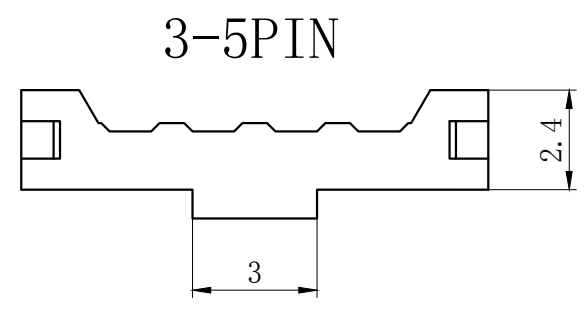
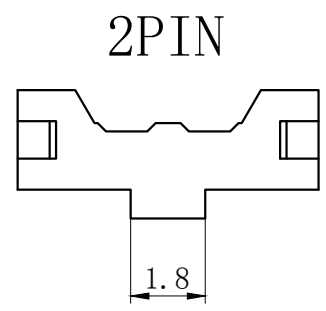
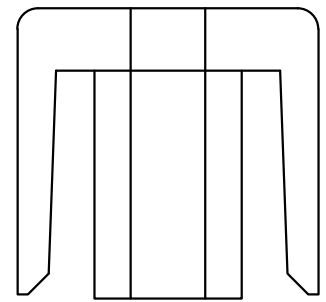
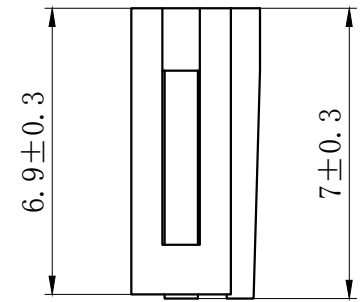
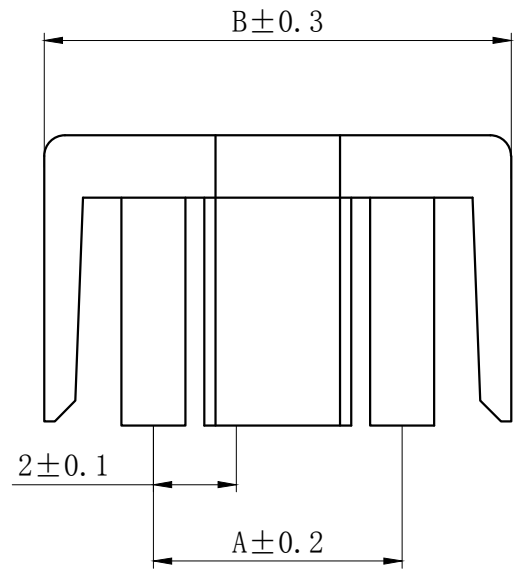
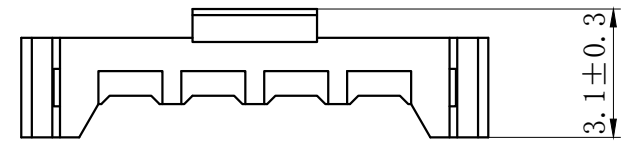

| Circuits | Product name | Dimensino (mm) | |
|----------|--------------|----------------|------|
| | | A | B |
| 2 | PA-H-2S | 2.0 | 7.3 |
| 3 | PA-H-3S | 4.0 | 9.3 |
| 4 | PA-H-4S | 6.0 | 11.3 |
| 5 | PA-H-5S | 8.0 | 13.3 |

| GENERAL TOLERANCES (UNLESS SPECIFIED) | | ZHE JIANG DELI CONNECTORS CO ., LTD | |
|---------------------------------------|---------------|-------------------------------------|-----------------------------------|
| .X: ± 0.25 | X° : ± 3.0° | PRODUCT NAME: | TITLE: 2.0 mm Pitch Wire To Board |
| .XX: ± 0.15 | .X° : ± 2.0° | DL20035 (PA-H)-S | |
| .XXX: ± 0.01 | .XX° : ± 1.0° | DR: Chen Quan Long | DATE:19/08/01 |
| FINISH: | | CHKD: Wu Hui | DATE:19/08/01 |
| DRAWING NO: | | APPD:Ren An De | DATE:19/08/01 |
| | | PART NO: | |
| | | SCALE: N/A | PAGE: 1/2 |
| | | UNITS: mm | REV. : A |

| | | | |
|------|----------------------|------|------|
| REV. | REVISION DESCRIPTION | DATE | APPD |
| | | | |

NOTES

Available in 06 through 16 Circuits.
Mates with DL20035-Y Series Housing.
Material : Nylon UL94V-0(2).
Green Material RoHS Compliant.

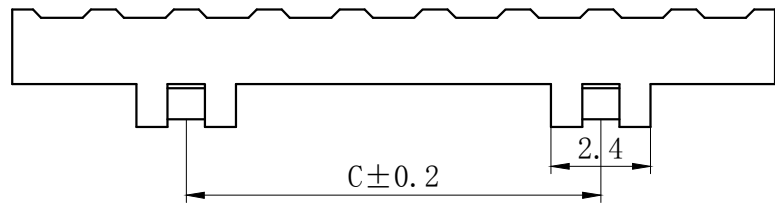
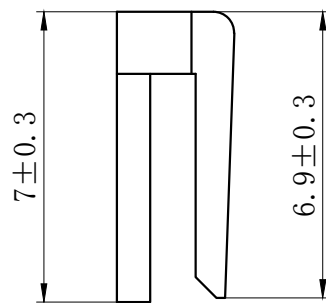
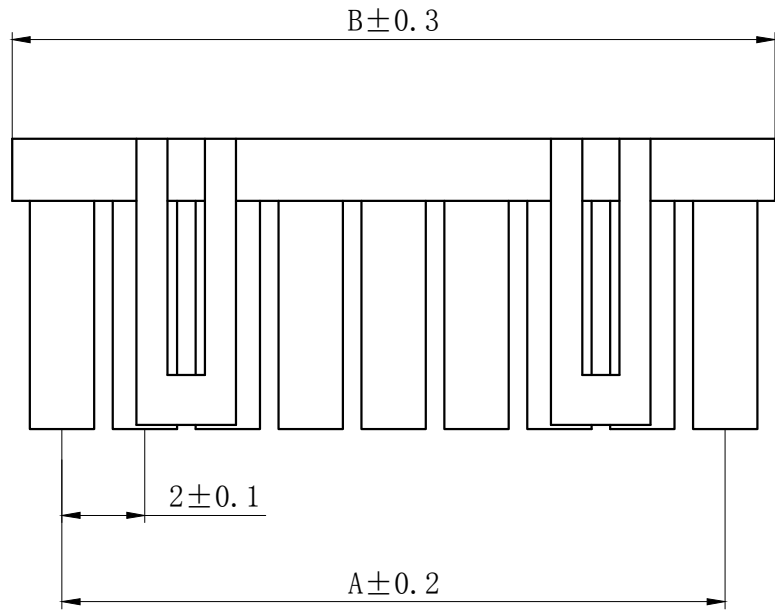
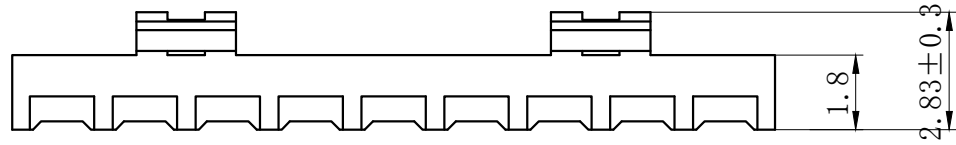

| Circuits | Product name | Dimensino(mm) | | |
|----------|--------------|---------------|------|------|
| | | A | B | C |
| 6 | PA-H-6S | 10.0 | 12.4 | 10.0 |
| 7 | PA-H-7S | 12.0 | 14.4 | 10.0 |
| 8 | PA-H-8S | 14.0 | 16.4 | 10.0 |
| 9 | PA-H-9S | 16.0 | 18.4 | 10.0 |
| 10 | PA-H-10S | 18.0 | 20.4 | 17.4 |
| 11 | PA-H-11S | 20.0 | 22.4 | 17.4 |
| 12 | PA-H-12S | 22.0 | 24.4 | 17.4 |
| 13 | PA-H-13S | 24.0 | 26.4 | 17.4 |
| 14 | PA-H-14S | 26.0 | 28.4 | 17.4 |
| 15 | PA-H-15S | 28.0 | 30.4 | 17.4 |
| 16 | PA-H-16S | 30.0 | 32.4 | 17.4 |

| | | | |
|--|--------------|--|---|
| GENERAL TOLERANCES (UNLESS SPECIFIED) | | ZHE JIANG DELI CONNECTORS CO., LTD | |
| .X: ± 0.25 | X°: ± 3.0° | PRODUCT NAME: DL20035 (PA-H)-S | TITLE: 2.0 mm Pitch Wire To Board |
| .XX: ± 0.15 | .X°: ± 2.0° | DR: Chen Quan Long | DATE:19/08/01 |
| .XXX: ± 0.01 | .XX°: ± 1.0° | CHKD: Wu Hui | DATE:19/08/01 |
| FINISH: | | APPD:Ren An De | DATE:19/08/01 |
| DRAWING NO: | | | |

| REV. | REVISION DESCRIPTION | DATE | APPD |
|------|----------------------|------|------|
| | | | |

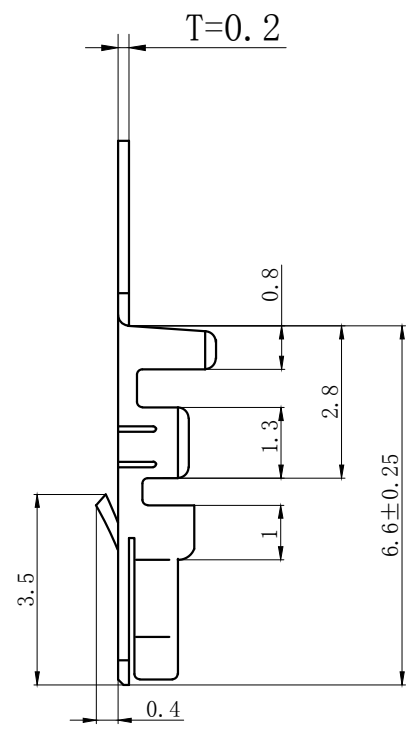
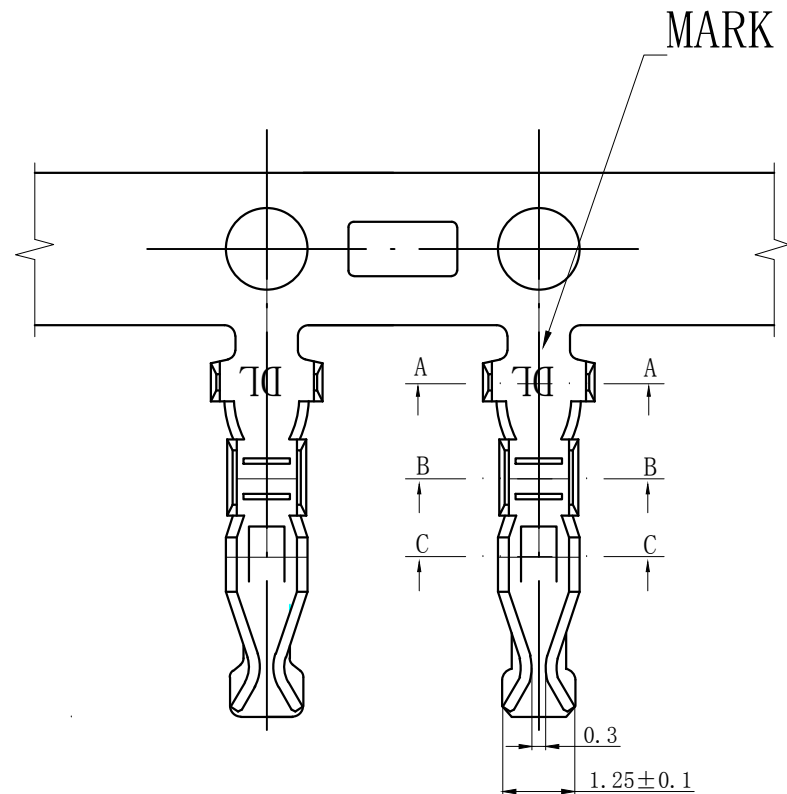

NOTES

Used in DL20003-Y Series Housing.
 Accepts AWG #28~22 Wire Range.
 0.08~ 0.33 mm² .
 Insulation O.D.=0.9~1.5 mm.
 Material : Phosphor Bronze .
 Finish: Tin plated.
 Thickness: 0.2 mm.

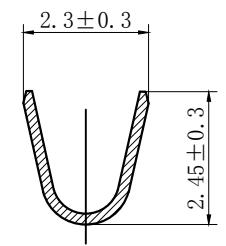

SECTION A-A

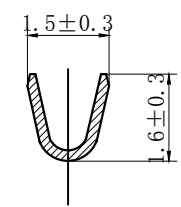

SECTION B-B

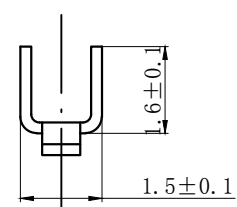

SECTION C-C

| GENERAL TOLERANCES (UNLESS SPECIFIED) | | ZHE JIANG DELI CONNECTORS CO., LTD | |
|--|---------------|--|---|
| .X: ± 0.25 | X° : ± 3.0° | PRODUCT NAME: DL20003 (PA)-T | TITLE: 2.00 mm Pitch Crimp Terminal |
| .XX: ± 0.15 | .X° : ± 2.0° | DR:Chen Quan Long | DATE:20.3.31 |
| .XXX: ± 0.01 | .XX° : ± 1.0° | CHKD:Wu Hui | DATE:20.3.31 |
| DRAWING NO: | | APPD:Ren An De | DATE:20.3.31 |
| | | SCALE: N/A | PAGE: 1/1 |
| | | UNITS: mm | REV.: A |

| REV. | REVISION DESCRIPTION | DATE | APPD |
|------|----------------------|------|------|
| | | | |

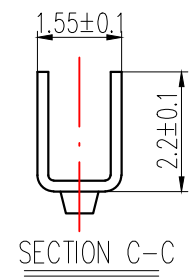
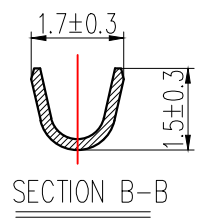
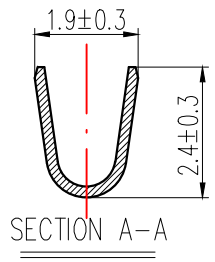
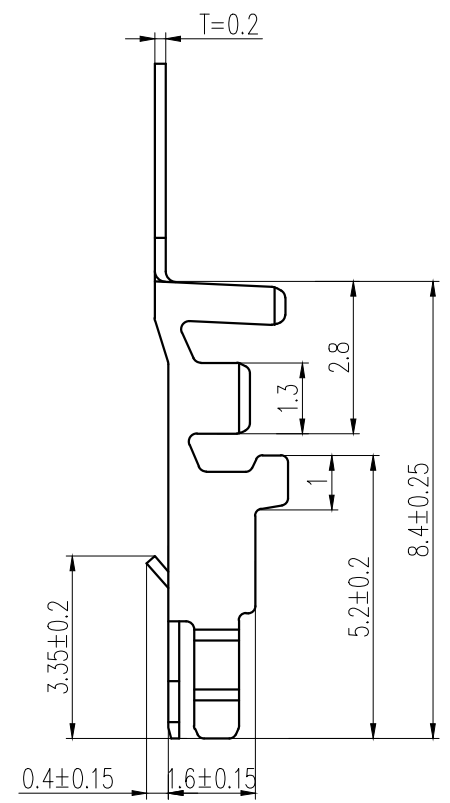
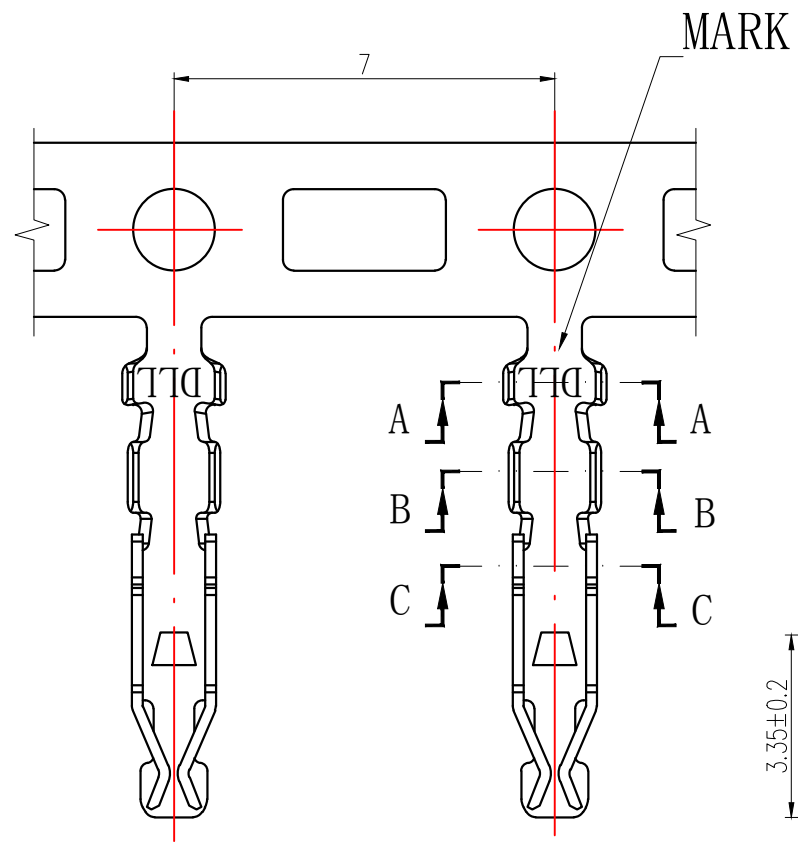

NOTES

- Used in DL20035-Y Series Housing.
- Accepts AWG #26~22 Wire Range.
0.13~ 0.33 mm² .
- Insulation O.D.=0.9~1.5 mm.
- Material : Phosphor Bronze .
- Finish: Tin plated.
- Thickness: 0.2 mm.

| GENERAL TOLERANCES (UNLESS SPECIFIED) | | ZHE JIANG DELI CONNECTORS CO., LTD | |
|--|---------------|--|---|
| .X: ± 0.25 | X° : ± 3.0° | PRODUCT NAME: DL20035 (PA-H)-T | TITLE: 2.00 mm Pitch Crimp Terminal |
| .XX: ± 0.15 | .X° : ± 2.0° | DR:Chen Quan Long | DATE:22.3.31 |
| .XXX: ± 0.01 | .XX° : ± 1.0° | CHKD:Wu Hui | DATE:22.3.31 |
| DRAWING NO: | | APPD:Ren An De | DATE:22.3.31 |
| | | SCALE: N/A | PAGE: 1/1 |
| | | UNITS: mm | REV.: A |

| REV. | REVISION DESCRIPTION | DATE | APPD |
|------|----------------------|------|------|
| | | | |

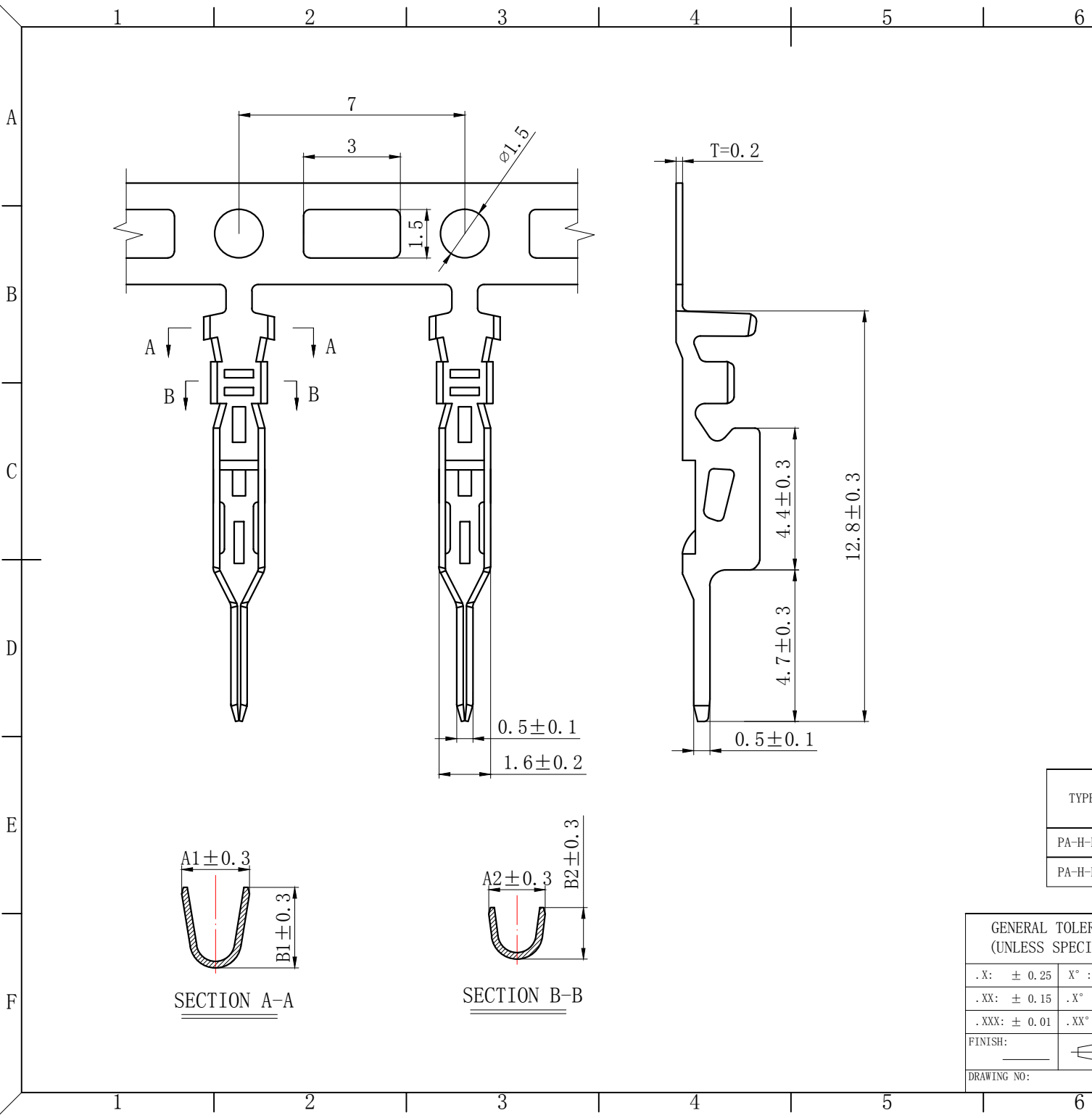

技术特性/Specifications:
 额定电压Rated voltage :250V AC.DC.
 额定电流Rated current :3A AC.DC.
 接触电阻Contact resistance:20MΩ MAX
 绝缘电阻Insulation resistance: 1000 MΩ MIN
 耐压Withstand voltage:800V AC/minute
 环境温度Ambient temperature: -40℃~+105℃
 材料/Materials:
 端子Terminal: 磷青铜Phosphor bronze ,
 镀锡Tin plated

| TYPE | Dimension mm | | | | 适用线规 AWG# |
|-----------|--------------|-----|------|-----|--------------|
| | A1 | B1 | A2 | B2 | |
| PA-H-RT | 2.1 | 2.5 | 1.75 | 1.6 | 26-22 |
| PA-H-RT-D | 2.1 | 2.5 | 1.75 | 1.4 | 28-24 |

| | | | | | |
|--|--------------|------------------------------------|---------------------------|--|-----------|
| GENERAL TOLERANCES (UNLESS SPECIFIED) | | ZHE JIANG DELI CONNECTORS CO., LTD | | | |
| .X: ± 0.25 | X°: ± 3.0° | PRODUCT NAME: DL25035 (PA-H)-RT | | TITLE: 2.00 mm Pitch Wire To Wire Terminal | |
| .XX: ± 0.15 | .X°: ± 2.0° | DR:Yuan Jun Rong DATE:21/12/30 | | PART NO: | |
| .XXX: ± 0.01 | .XX°: ± 1.0° | FINISH: | CHKD:Wu Hui DATE:21/12/30 | SCALE: N/A | PAGE: 1/1 |
| DRAWING NO: | | APPD:Ren An De | DATE:21/12/30 | UNITS: mm | REV.: A |

X-ON Electronics

Largest Supplier of Electrical and Electronic Components

Click to view similar products for [Headers & Wire Housings](#) category:

Click to view products by [DLL](#) manufacturer:

Other Similar products are found below :

[0015917161](#) [0022155065](#) [57102-F02-18ULF](#) [58102-G61-06LF](#) [582553-1](#) [01.001.5753.1](#) [0050291907](#) [02.125.8002.8](#) [609-3404](#) [61062-3](#)
[CSU011177004](#) [622-0430](#) [622-3653LF](#) [63453-116](#) [636-1030](#) [636-1427](#) [636-3427](#) [636-4007](#) [641938-9](#) [65495-038](#) [65692-001LF](#) [65781-018](#)
[65781-047](#) [65817-010LF](#) [65817-015LF](#) [67095-007LF](#) [67601157](#) [68631-112](#) [68645-018](#) [699319-000](#) [70.362.1628.0](#) [70-4210](#) [70-4226B](#) [70-](#)
[4853B](#) [71.350.2428.0](#) [733-134](#) [733-162](#) [760-3052](#) [MHR-64-VUAL](#) [80.063.4001.1](#) [800-90-001-10-001000](#) [801-43-002-10-013000](#)
[801-43-006-10-002000](#) [803-43-024-10-001000](#) [803-93-012-10-001000](#) [8-1437020-4](#) [819-22-004-30-001101](#) [820-22-006-30-001101](#)
[820-22-008-30-001101](#) [821-22-002-10-001101](#)