

技术特性/Specifications:

额定电压 Rated voltage: 250V AC, DC
额定电流 Rated current: 3A AC, DC
接触电阻 Contact resistance: 20m Ω max
绝缘电阻 Insulation resistance: 1000M Ω min
耐压 Withstand voltage: 800V AC/minute
环境温度 Ambient temperature: -40 $^{\circ}$ C~+105 $^{\circ}$ C
适用线规 Wire range: AWG#28~#22

| | | | |
|------|----------------------|------|------|
| REV. | REVISION DESCRIPTION | DATE | APPD |
| | | | |

16PIN以上

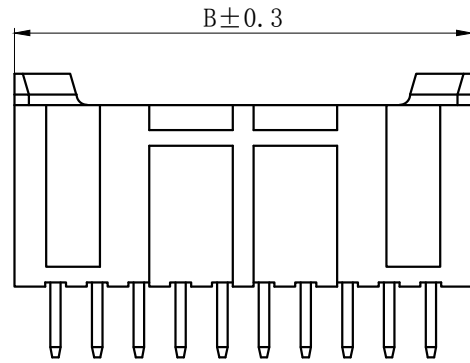

14PIN以下

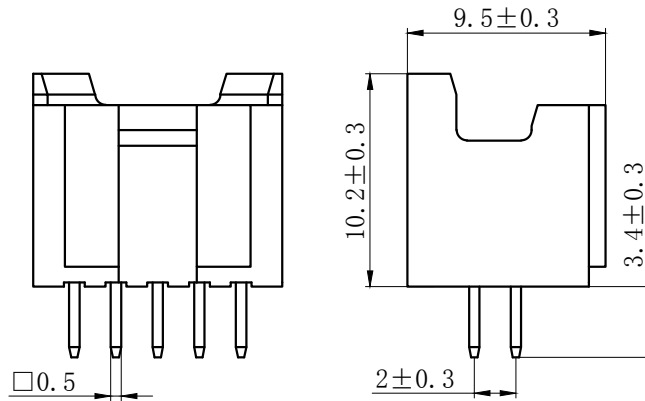

NOTES

Available in 04 through 40 Circuits.
 Mates with DL20034-Y Series Housing.
 Material : Nylon UL94V-0 (2) .
 0.50mm Square Pin.
 Pin Material : Brass / Tin-Plated.

30-40PIN

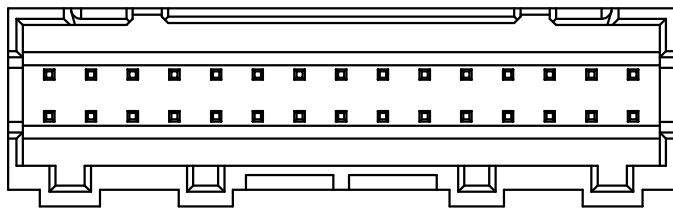

10-28PIN

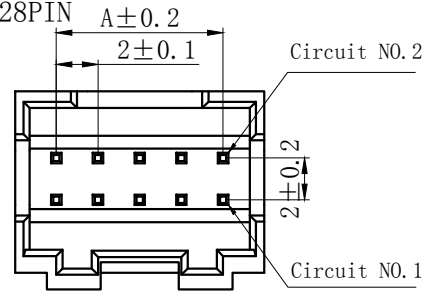

4-8PIN

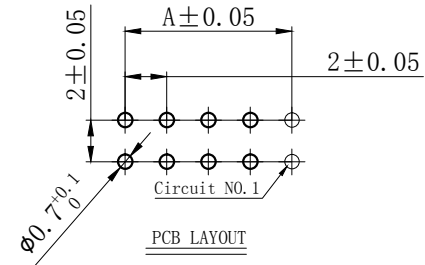
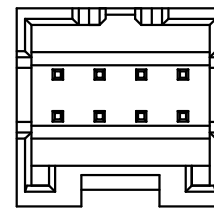

| Circuits | Type | Dimensino (mm) | | Circuits | Type | Dimensino (mm) | |
|----------|---------|----------------|-------|----------|---------|----------------|-------|
| | | A | B | | | A | B |
| 2X2 | PAD-4A | 2.00 | 6.00 | 2X12 | PAD-24A | 22.00 | 26.00 |
| 2X3 | PAD-6A | 4.00 | 8.00 | 2X13 | PAD-26A | 24.00 | 28.00 |
| 2X4 | PAD-8A | 6.00 | 10.00 | 2X14 | PAD-28A | 26.00 | 30.00 |
| 2X5 | PAD-10A | 8.00 | 12.00 | 2X15 | PAD-30A | 28.00 | 32.00 |
| 2X6 | PAD-12A | 10.00 | 14.00 | 2X16 | PAD-32A | 30.00 | 34.00 |
| 2X7 | PAD-14A | 12.00 | 16.00 | 2X17 | PAD-34A | 32.00 | 36.00 |
| 2X8 | PAD-16A | 14.00 | 18.00 | 2X18 | PAD-36A | 34.00 | 38.00 |
| 2X9 | PAD-18A | 16.00 | 20.00 | 2X19 | PAD-38A | 36.00 | 40.00 |
| 2X10 | PAD-20A | 18.00 | 22.00 | 2X20 | PAD-40A | 38.00 | 42.00 |
| 2X11 | PAD-22A | 20.00 | 24.00 | | | | |

| | | | |
|---------------------------------------|--------------|------------------------------------|--|
| GENERAL TOLERANCES (UNLESS SPECIFIED) | | ZHE JIANG DELI CONNECTORS CO., LTD | |
| .X: ± 0.25 | X°: ± 3.0° | PRODUCT NAME: DL20034-A (PAD-A) | TITLE: 2.00 mm Pitch Wire To Board Wafer |
| .XX: ± 0.15 | .X°: ± 2.0° | DR: Chen Quan Long | DATE:22/12/01 |
| .XXX: ± 0.01 | .XX°: ± 1.0° | CHKD: Wu Hui | DATE:22/12/01 |
| FINISH: | | APPD: Ren An De | DATE:22/12/01 |
| DRAWING NO: | | | |
| | | SCALE: N/A | PAGE: 1/1 |
| | | UNITS: mm | REV.: A |

| REV. | REVISION DESCRIPTION | DATE | APPD |
|------|----------------------|------|------|
| | | | |

NOTES

Available in 04 through 40 Circuits.
Mates with DL20034-Y Series Housing.
Material : Nylon UL94V-0 (2) .
0.50mm Square Pin.
Pin Material : Brass / Tin-Plated.

16PIN以上

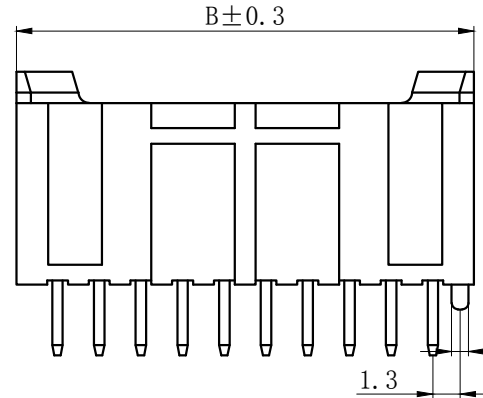

14PIN以下

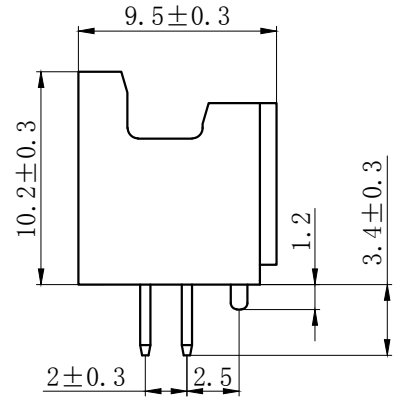
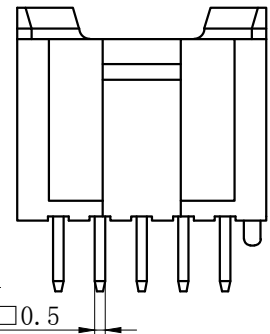

30-40PIN

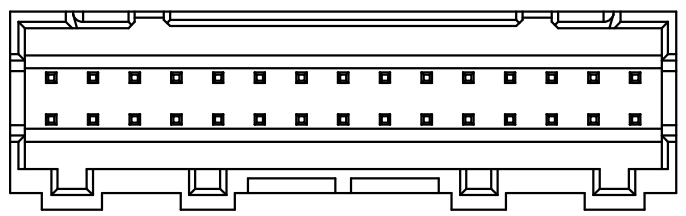

10-28PIN

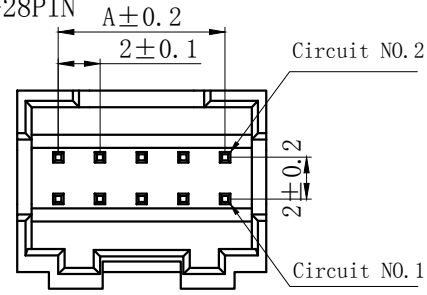

4-8PIN

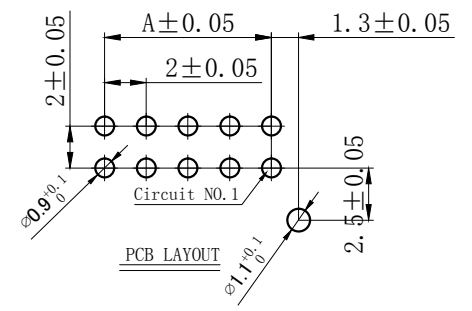
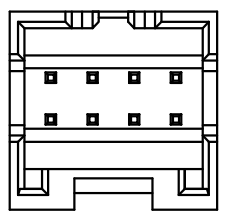

| Circuits | Type | Dimensino (mm) | | Circuits | Type | Dimensino (mm) | |
|----------|----------|----------------|-------|----------|----------|----------------|-------|
| | | A | B | | | A | B |
| 2X2 | PAD-4AS | 2.00 | 6.00 | 2X12 | PAD-24AS | 22.00 | 26.00 |
| 2X3 | PAD-6AS | 4.00 | 8.00 | 2X13 | PAD-26AS | 24.00 | 28.00 |
| 2X4 | PAD-8AS | 6.00 | 10.00 | 2X14 | PAD-28AS | 26.00 | 30.00 |
| 2X5 | PAD-10AS | 8.00 | 12.00 | 2X15 | PAD-30AS | 28.00 | 32.00 |
| 2X6 | PAD-12AS | 10.00 | 14.00 | 2X16 | PAD-32AS | 30.00 | 34.00 |
| 2X7 | PAD-14AS | 12.00 | 16.00 | 2X17 | PAD-34AS | 32.00 | 36.00 |
| 2X8 | PAD-16AS | 14.00 | 18.00 | 2X18 | PAD-36AS | 34.00 | 38.00 |
| 2X9 | PAD-18AS | 16.00 | 20.00 | 2X19 | PAD-38AS | 36.00 | 40.00 |
| 2X10 | PAD-20AS | 18.00 | 22.00 | 2X20 | PAD-40AS | 38.00 | 42.00 |
| 2X11 | PAD-22AS | 20.00 | 24.00 | | | | |

| | | | |
|---------------------------------------|--------------|--------------------------------------|--|
| GENERAL TOLERANCES (UNLESS SPECIFIED) | | ZHE JIANG DELI CONNECTORS CO., LTD | |
| .X: ± 0.25 | X°: ± 3.0° | PRODUCT NAME: DL20034-AS (PAD-AS) | TITLE: 2.00 mm Pitch Wire To Board Wafer |
| .XX: ± 0.15 | .X°: ± 2.0° | DR: Chen Quan Long | DATE:22/12/01 |
| .XXX: ± 0.01 | .XX°: ± 1.0° | CHKD: Wu Hui | DATE:22/12/01 |
| FINISH: | | APPD: Ren An De | DATE:22/12/01 |
| DRAWING NO: | | UNITS: mm | REV.: A |
| | | SCALE: N/A | PAGE: 1/1 |
| | | PART NO: | |

| | | | |
|------|----------------------|------|------|
| REV. | REVISION DESCRIPTION | DATE | APPD |
| | | | |

A

16PIN以上

14PIN以下

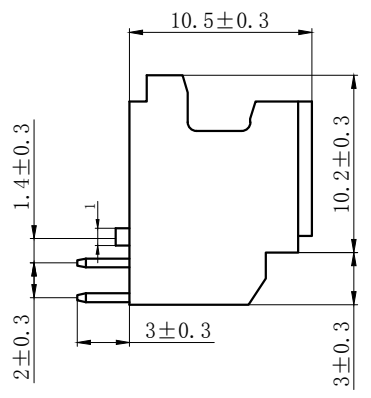
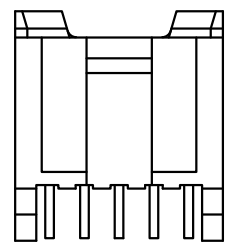
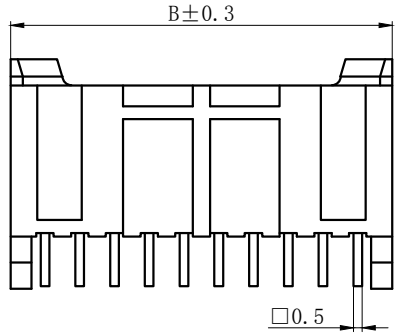

NOTES

Available in 04 through 40 Circuits.
 Mates with DL20034-Y Series Housing.
 Material : Nylon UL94V-0 (2) .
 0.50mm Square Pin.
 Pin Material : Brass / Tin-Plated.

B

C

30-40PIN

10-28PIN

4-8PIN

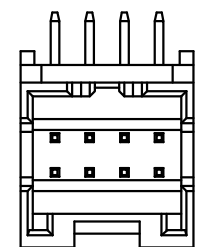
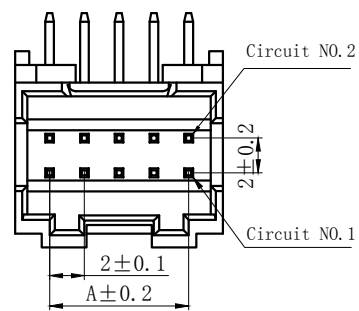
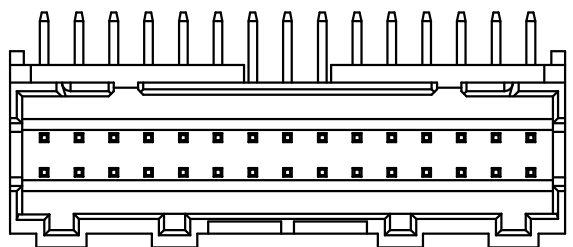

D

E

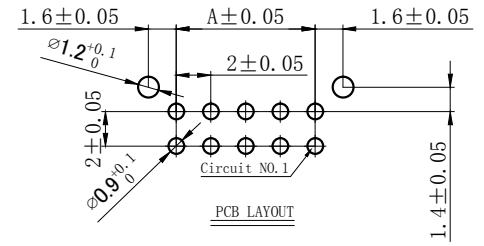

| Circuits | Type | Dimensino(mm) | | Circuits | Type | Dimensino(mm) | |
|----------|-------------|---------------|-------|----------|-------------|---------------|-------|
| | | A | B | | | A | B |
| 2X2 | PAD-4AWD-S | 2.00 | 6.00 | 2X12 | PAD-24AWD-S | 22.00 | 26.00 |
| 2X3 | PAD-6AWD-S | 4.00 | 8.00 | 2X13 | PAD-26AWD-S | 24.00 | 28.00 |
| 2X4 | PAD-8AWD-S | 6.00 | 10.00 | 2X14 | PAD-28AWD-S | 26.00 | 30.00 |
| 2X5 | PAD-10AWD-S | 8.00 | 12.00 | 2X15 | PAD-30AWD-S | 28.00 | 32.00 |
| 2X6 | PAD-12AWD-S | 10.00 | 14.00 | 2X16 | PAD-32AWD-S | 30.00 | 34.00 |
| 2X7 | PAD-14AWD-S | 12.00 | 16.00 | 2X17 | PAD-34AWD-S | 32.00 | 36.00 |
| 2X8 | PAD-16AWD-S | 14.00 | 18.00 | 2X18 | PAD-36AWD-S | 34.00 | 38.00 |
| 2X9 | PAD-18AWD-S | 16.00 | 20.00 | 2X19 | PAD-38AWD-S | 36.00 | 40.00 |
| 2X10 | PAD-20AWD-S | 18.00 | 22.00 | 2X20 | PAD-40AWD-S | 38.00 | 42.00 |
| 2X11 | PAD-22AWD-S | 20.00 | 24.00 | | | | |

F

| | | | |
|---------------------------------------|--------------|--|---|
| GENERAL TOLERANCES (UNLESS SPECIFIED) | | ZHE JIANG DELI CONNECTORS CO., LTD | |
| .X: ± 0.25 | X°: ± 3.0° | PRODUCT NAME: DL20034-AWD-S (PAD-AWD-S) | TITLE: 2.00 mm Pitch Wire To Board Wafer |
| .XX: ± 0.15 | .X°: ± 2.0° | DR: Chen Quan Long | DATE:22/12/01 |
| .XXX: ± 0.01 | .XX°: ± 1.0° | CHKD: Wu Hui | DATE:22/12/01 |
| FINISH: | | APPD: Ren An De | DATE:22/12/01 |
| DRAWING NO: | | UNITS: mm | REV.: A |

1 2 3 4 5 6 7 8

| | | | |
|------|----------------------|------|------|
| REV. | REVISION DESCRIPTION | DATE | APPD |
| | | | |

NOTES

Available in 04 through 40 Circuits.
 Match with DL20034 series Wafer.
 Material : Nylon UL94V-0 (2) .
 Accepts DL20034-T Crimp Terminal.

16PIN以上

14PIN以下

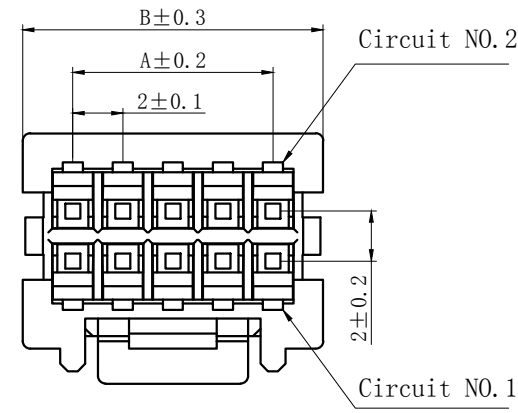
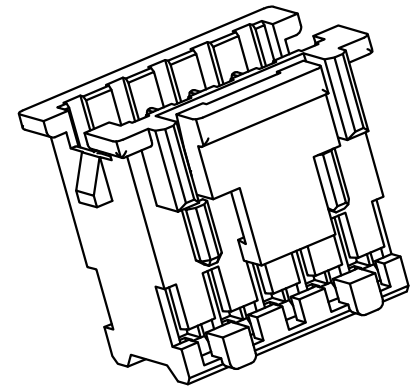
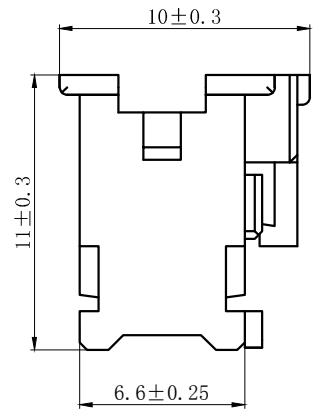
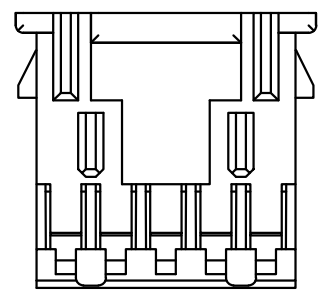
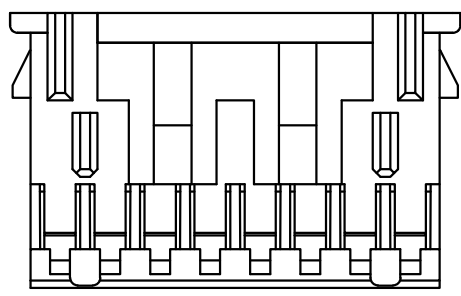

| Circuits | Type | Dimensino(mm) | | Circuits | Type | Dimensino(mm) | |
|----------|---------|---------------|-------|----------|---------|---------------|-------|
| | | A | B | | | A | B |
| 2X2 | PAD-4Y | 2.00 | 6.00 | 2X12 | PAD-24Y | 22.00 | 26.00 |
| 2X3 | PAD-6Y | 4.00 | 8.00 | 2X13 | PAD-26Y | 24.00 | 28.00 |
| 2X4 | PAD-8Y | 6.00 | 10.00 | 2X14 | PAD-28Y | 26.00 | 30.00 |
| 2X5 | PAD-10Y | 8.00 | 12.00 | 2X15 | PAD-30Y | 28.00 | 32.00 |
| 2X6 | PAD-12Y | 10.00 | 14.00 | 2X16 | PAD-32Y | 30.00 | 34.00 |
| 2X7 | PAD-14Y | 12.00 | 16.00 | 2X17 | PAD-34Y | 32.00 | 36.00 |
| 2X8 | PAD-16Y | 14.00 | 18.00 | 2X18 | PAD-36Y | 34.00 | 38.00 |
| 2X9 | PAD-18Y | 16.00 | 20.00 | 2X19 | PAD-38Y | 36.00 | 40.00 |
| 2X10 | PAD-20Y | 18.00 | 22.00 | 2X20 | PAD-40Y | 38.00 | 42.00 |
| 2X11 | PAD-22Y | 20.00 | 24.00 | | | | |

| | | | |
|---------------------------------------|---------------|-------------------------------------|---------------------------------|
| GENERAL TOLERANCES (UNLESS SPECIFIED) | | ZHE JIANG DELI CONNECTORS CO ., LTD | |
| .X: ± 0.25 | X° : ± 3.0° | PRODUCT NAME: DL20034-Y (PAD-Y) | TITLE: 2.00 mm Pitch Housing |
| .XX: ± 0.15 | .X° : ± 2.0° | DR: Chen Quan Long | DATE:22/12/01 |
| .XXX: ± 0.01 | .XX° : ± 1.0° | CHKD:Wu Hui | DATE:22/12/01 |
| FINISH: | | APPD:Ren An De | DATE:22/12/01 |
| DRAWING NO: | | SCALE: N/A | PAGE: 1/1 |
| | | UNITS: mm | REV.: A |

A
B
C
D
E
F

A
B
C
D
E
F

1 2 3 4 5 6 7 8

| | | | |
|------|----------------------|------|------|
| REV. | REVISION DESCRIPTION | DATE | APPD |
| | | | |

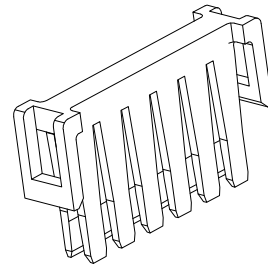
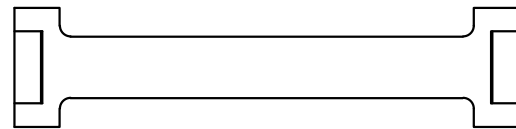
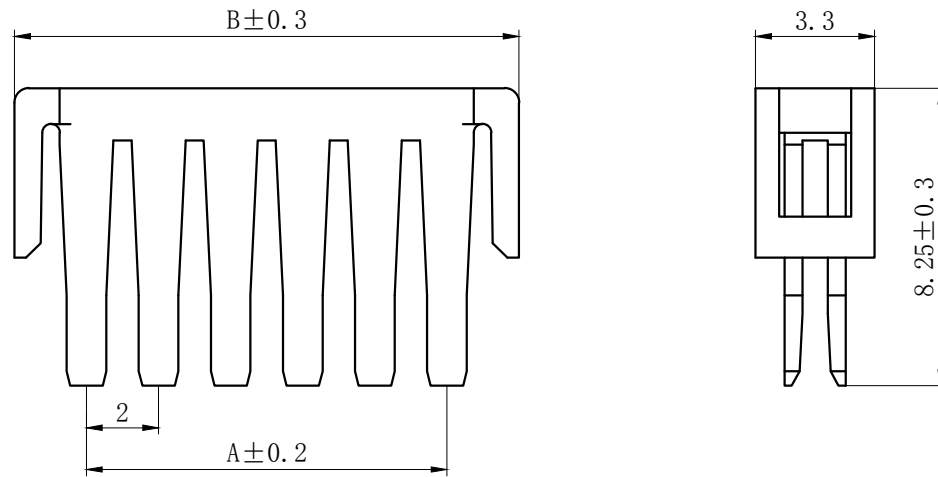

NOTES

Available in 04 through 40 Circuits.
 Mates with DL20034-Y Series Housing.
 Material : Nylon UL94V-0(2).
 Green Material RoHS Compliant.

| Circuits | Type | Dimension (mm) | | Circuits | Type | Dimension (mm) | |
|----------|---------|----------------|-------|----------|---------|----------------|-------|
| | | A | B | | | A | B |
| 2X2 | PAD-4S | 2.00 | 6.00 | 2X12 | PAD-24S | 22.00 | 26.00 |
| 2X3 | PAD-6S | 4.00 | 8.00 | 2X13 | PAD-26S | 24.00 | 28.00 |
| 2X4 | PAD-8S | 6.00 | 10.00 | 2X14 | PAD-28S | 26.00 | 30.00 |
| 2X5 | PAD-10S | 8.00 | 12.00 | 2X15 | PAD-30S | 28.00 | 32.00 |
| 2X6 | PAD-12S | 10.00 | 14.00 | 2X16 | PAD-32S | 30.00 | 34.00 |
| 2X7 | PAD-14S | 12.00 | 16.00 | 2X17 | PAD-34S | 32.00 | 36.00 |
| 2X8 | PAD-16S | 14.00 | 18.00 | 2X18 | PAD-36S | 34.00 | 38.00 |
| 2X9 | PAD-18S | 16.00 | 20.00 | 2X19 | PAD-38S | 36.00 | 40.00 |
| 2X10 | PAD-20S | 18.00 | 22.00 | 2X20 | PAD-40S | 38.00 | 42.00 |
| 2X11 | PAD-22S | 20.00 | 24.00 | | | | |

| | | | |
|--|---------------|------------------------------------|-----------------------------------|
| GENERAL TOLERANCES (UNLESS SPECIFIED) | | ZHE JIANG DELI CONNECTORS CO., LTD | |
| .X: ± 0.25 | X° : ± 3.0° | PRODUCT NAME: | TITLE: 2.0 mm Pitch Wire To Board |
| .XX: ± 0.15 | .X° : ± 2.0° | DL20034-S (PAD-S) | |
| .XXX: ± 0.01 | .XX° : ± 1.0° | DR: Chen Quan Long | DATE: 19/08/01 |
| FINISH: | | CHKD: Wu Hui | DATE: 19/08/01 |
| DRAWING NO: | | APPD: Ren An De | DATE: 19/08/01 |
| | | | PART NO: |
| | | | SCALE: N/A |
| | | | PAGE: 1/1 |
| | | | UNITS: mm |
| | | | REV.: A |

| REV. | REVISION DESCRIPTION | DATE | APPD |
|------|----------------------|------|------|
| | | | |

NOTES

Used in DL20001-Y Series Housing.

Accepts AWG #28~22 Wire Range.

0.08~ 0.33 mm² .

Insulation O.D.=0.8~1.5 mm.

Material : Phosphor Bronze .

Finish: Tin plated.

Thickness: 0.2 mm.

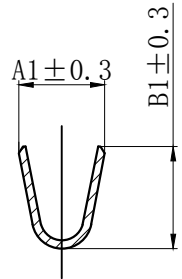
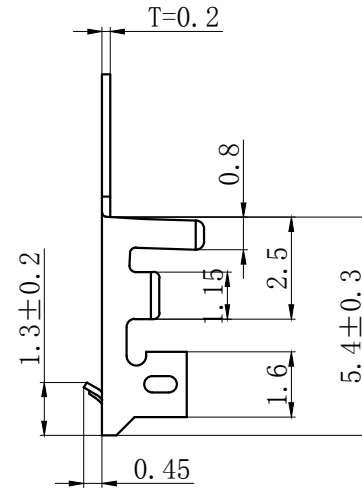
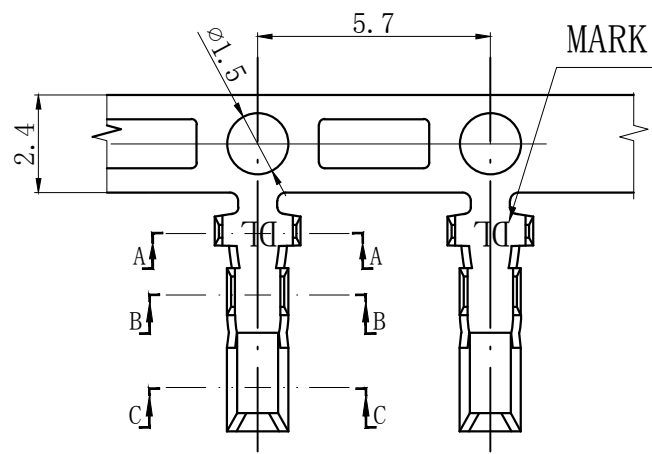

SECTION A-A

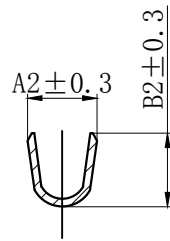

SECTION B-B

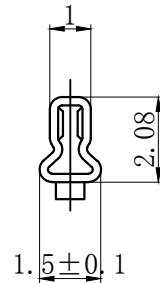

SECTION C-C

| TYPE | Dimension mm | | | | Applicable wires AWG# |
|--------|--------------|-----|-----|-----|--------------------------|
| | A1 | B1 | A2 | B2 | |
| PH-T-G | 2.1 | 2.5 | 1.7 | 1.8 | 24-22 |
| PH-T | 2.1 | 2.5 | 1.5 | 1.4 | 26-24 |
| PH-T-D | 1.9 | 1.9 | 1.2 | 1.2 | 28-26 |

GENERAL TOLERANCES
(UNLESS SPECIFIED)

| | |
|--------------|---------------|
| .X: ± 0.25 | X° : ± 3.0° |
| .XX: ± 0.15 | .X° : ± 2.0° |
| .XXX: ± 0.01 | .XX° : ± 1.0° |
| FINISH: | |
| DRAWING NO: | |

ZHE JIANG DELI CONNECTORS CO., LTD

| | | | |
|-----------------------------------|---------------|---|-----------|
| PRODUCT NAME: DL20001-T (PH-T) | | TITLE: 2.00 mm Pitch Crimp Terminal | |
| DR:Chen Quan Long | DATE:20/01/26 | PART NO: | |
| CHKD: Wu Hui | DATE:20/01/26 | SCALE: N/A | PAGE: 1/1 |
| APPD:Ren An De | DATE:20/01/26 | UNITS: mm | REV.: A |

X-ON Electronics

Largest Supplier of Electrical and Electronic Components

Click to view similar products for [RF Connector Accessories](#) category:

Click to view products by [DLL](#) manufacturer:

Other Similar products are found below :

[89674-0712](#) [FERRULE-174](#) [R141802000](#) [R141842000](#) [R141862000W](#) [R280907000](#) [AX102907](#) [HP-500](#) [2098-3251-94](#) [KA-81-02](#) [KA-81-05](#) [KN-89-12](#) [89674-0805](#) [FERRULE-223](#) [202102-11](#) [R280468000](#) [R280510000](#) [RFI155-1](#) [RFI25-12-D3](#) [RFI25-4-D2](#) [RFI75-12-D2](#) [RFI97-14](#) [360HS001M2508M6](#) [4-1532137-4](#) [HRM-514S\(40\)](#) [5-21085-0](#) [111062-0490](#) [112122-SOD-LUG](#) [IPP-2014](#) [RFI95-14-D2](#) [MX-913/U\(45\)](#) [1736-1511-075](#) [RFI75-2-D3](#) [RFI25-3-D3](#) [R280469010](#) [RFI85-4](#) [896110450](#) [660-024M09S5-01](#) [1403137-1](#) [360HB001M2512H](#) [360HS001M1716M3](#) [380HS115M2508H3](#) [380HS001M1716M4](#) [FERRULE-316DB](#) [105274-2000](#) [73415-1970](#) [R280755050W](#) [52014041A](#) [R447120000](#) [BNC-JCAP\(01\)](#)