

技术特性/Specifications:

额定电压 Rated voltage: 250V AC, DC
额定电流 Rated current: 3A AC, DC
接触电阻 Contact resistance: 20m Ω max
绝缘电阻 Insulation resistance: 1000M Ω min
耐压 Withstand voltage: 800V AC/minute
环境温度 Ambient temperature: -40 $^{\circ}$ C~+105 $^{\circ}$ C
适用线规 Wire range: AWG#28~#22

REV.	REVISION DESCRIPTION	DATE	APPD

16PIN以上

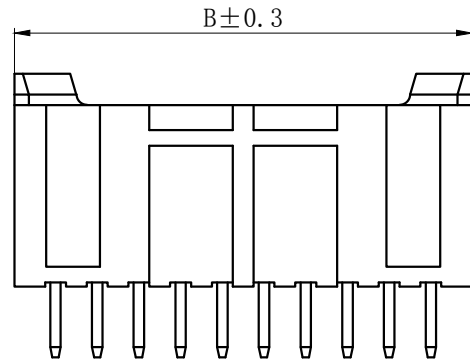

14PIN以下

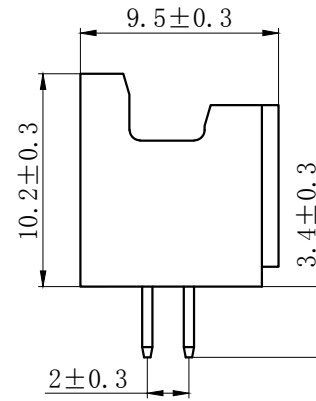
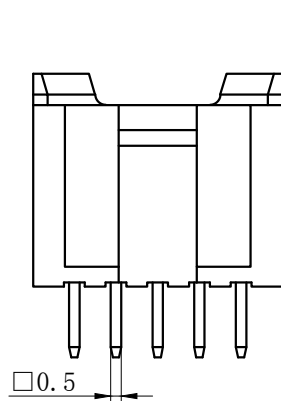

NOTES

Available in 04 through 40 Circuits.
 Mates with DL20034-Y Series Housing.
 Material : Nylon UL94V-0 (2) .
 0.50mm Square Pin.
 Pin Material : Brass / Tin-Plated.

30-40PIN

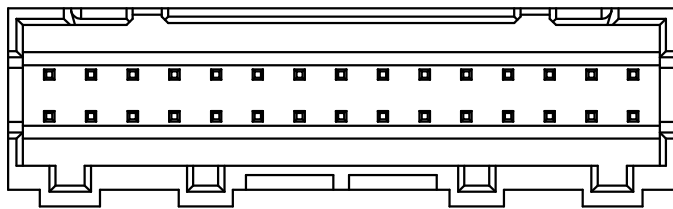

10-28PIN

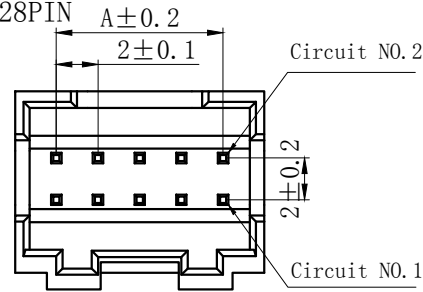

4-8PIN

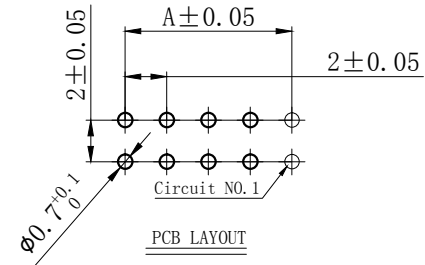
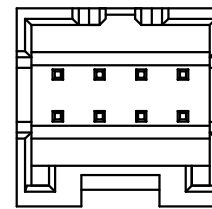

Circuits	Type	Dimensino (mm)		Circuits	Type	Dimensino (mm)	
		A	B			A	B
2X2	PAD-4A	2.00	6.00	2X12	PAD-24A	22.00	26.00
2X3	PAD-6A	4.00	8.00	2X13	PAD-26A	24.00	28.00
2X4	PAD-8A	6.00	10.00	2X14	PAD-28A	26.00	30.00
2X5	PAD-10A	8.00	12.00	2X15	PAD-30A	28.00	32.00
2X6	PAD-12A	10.00	14.00	2X16	PAD-32A	30.00	34.00
2X7	PAD-14A	12.00	16.00	2X17	PAD-34A	32.00	36.00
2X8	PAD-16A	14.00	18.00	2X18	PAD-36A	34.00	38.00
2X9	PAD-18A	16.00	20.00	2X19	PAD-38A	36.00	40.00
2X10	PAD-20A	18.00	22.00	2X20	PAD-40A	38.00	42.00
2X11	PAD-22A	20.00	24.00				

GENERAL TOLERANCES (UNLESS SPECIFIED)		ZHE JIANG DELI CONNECTORS CO., LTD	
.X: ± 0.25	X°: ± 3.0°	PRODUCT NAME: DL20034-A (PAD-A)	TITLE: 2.00 mm Pitch Wire To Board Wafer
.XX: ± 0.15	.X°: ± 2.0°	DR: Chen Quan Long	DATE:22/12/01
.XXX: ± 0.01	.XX°: ± 1.0°	CHKD: Wu Hui	DATE:22/12/01
FINISH:		APPD: Ren An De	DATE:22/12/01
DRAWING NO:			
			PART NO:
			SCALE: N/A
			PAGE: 1/1
			UNITS: mm
			REV.: A

REV.	REVISION DESCRIPTION	DATE	APPD

NOTES

Available in 04 through 40 Circuits.
Mates with DL20034-Y Series Housing.
Material : Nylon UL94V-0 (2) .
0.50mm Square Pin.
Pin Material : Brass / Tin-Plated.

16PIN以上

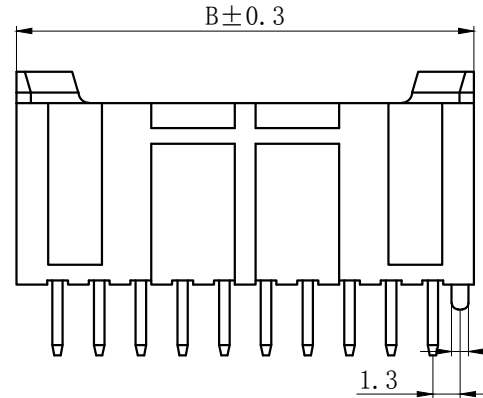

14PIN以下

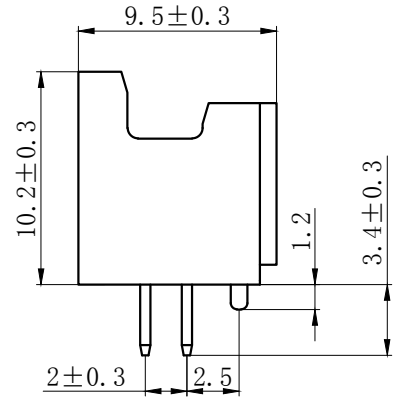
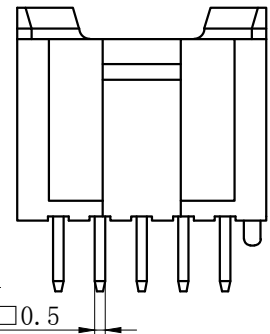

30-40PIN

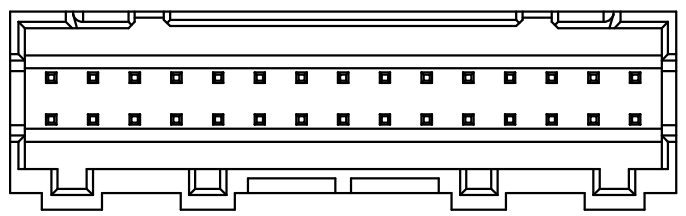

10-28PIN

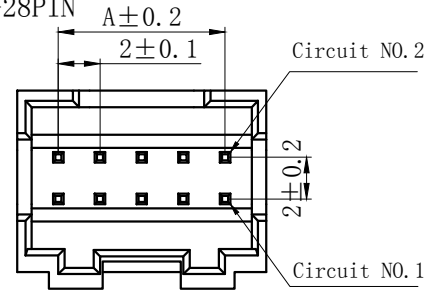

4-8PIN

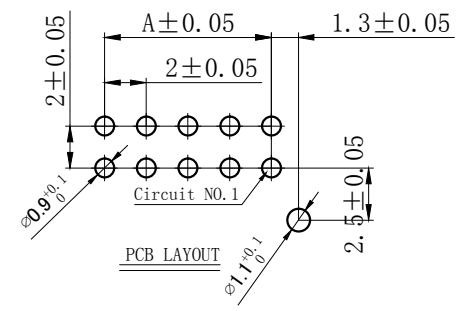
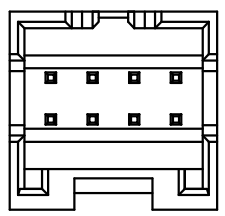

Circuits	Type	Dimensino (mm)		Circuits	Type	Dimensino (mm)	
		A	B			A	B
2X2	PAD-4AS	2.00	6.00	2X12	PAD-24AS	22.00	26.00
2X3	PAD-6AS	4.00	8.00	2X13	PAD-26AS	24.00	28.00
2X4	PAD-8AS	6.00	10.00	2X14	PAD-28AS	26.00	30.00
2X5	PAD-10AS	8.00	12.00	2X15	PAD-30AS	28.00	32.00
2X6	PAD-12AS	10.00	14.00	2X16	PAD-32AS	30.00	34.00
2X7	PAD-14AS	12.00	16.00	2X17	PAD-34AS	32.00	36.00
2X8	PAD-16AS	14.00	18.00	2X18	PAD-36AS	34.00	38.00
2X9	PAD-18AS	16.00	20.00	2X19	PAD-38AS	36.00	40.00
2X10	PAD-20AS	18.00	22.00	2X20	PAD-40AS	38.00	42.00
2X11	PAD-22AS	20.00	24.00				

GENERAL TOLERANCES (UNLESS SPECIFIED)		ZHE JIANG DELI CONNECTORS CO., LTD	
.X: ± 0.25	X°: ± 3.0°	PRODUCT NAME: DL20034-AS (PAD-AS)	TITLE: 2.00 mm Pitch Wire To Board Wafer
.XX: ± 0.15	.X°: ± 2.0°	DR: Chen Quan Long	DATE:22/12/01
.XXX: ± 0.01	.XX°: ± 1.0°	CHKD: Wu Hui	DATE:22/12/01
FINISH:		APPD: Ren An De	DATE:22/12/01
DRAWING NO:		UNITS: mm	REV.: A
		PART NO:	SCALE: N/A
			PAGE: 1/1

REV.	REVISION DESCRIPTION	DATE	APPD

16PIN以上

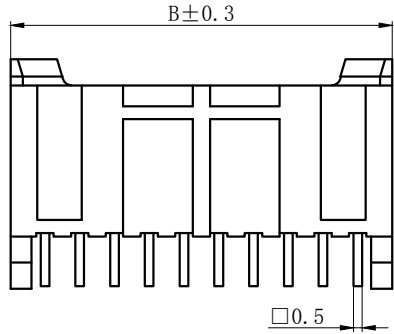

14PIN以下

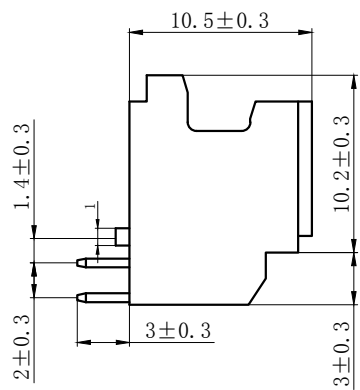
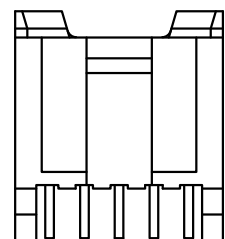

NOTES

Available in 04 through 40 Circuits.
 Mates with DL20034-Y Series Housing.
 Material : Nylon UL94V-0 (2) .
 0.50mm Square Pin.
 Pin Material : Brass / Tin-Plated.

30-40PIN

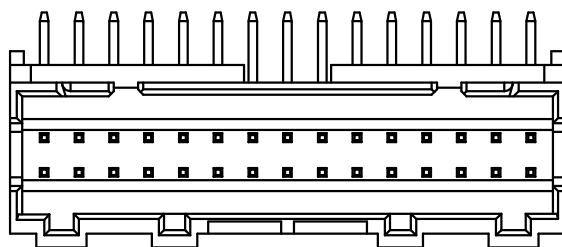

10-28PIN

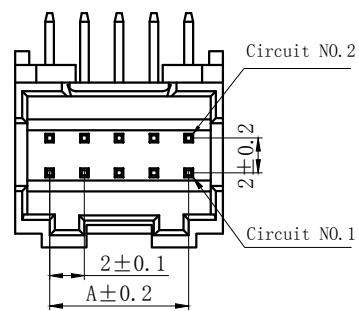

4-8PIN

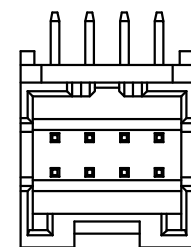

Circuits	Type	Dimensino(mm)		Circuits	Type	Dimensino(mm)	
		A	B			A	B
2X2	PAD-4AWD-S	2.00	6.00	2X12	PAD-24AWD-S	22.00	26.00
2X3	PAD-6AWD-S	4.00	8.00	2X13	PAD-26AWD-S	24.00	28.00
2X4	PAD-8AWD-S	6.00	10.00	2X14	PAD-28AWD-S	26.00	30.00
2X5	PAD-10AWD-S	8.00	12.00	2X15	PAD-30AWD-S	28.00	32.00
2X6	PAD-12AWD-S	10.00	14.00	2X16	PAD-32AWD-S	30.00	34.00
2X7	PAD-14AWD-S	12.00	16.00	2X17	PAD-34AWD-S	32.00	36.00
2X8	PAD-16AWD-S	14.00	18.00	2X18	PAD-36AWD-S	34.00	38.00
2X9	PAD-18AWD-S	16.00	20.00	2X19	PAD-38AWD-S	36.00	40.00
2X10	PAD-20AWD-S	18.00	22.00	2X20	PAD-40AWD-S	38.00	42.00
2X11	PAD-22AWD-S	20.00	24.00				

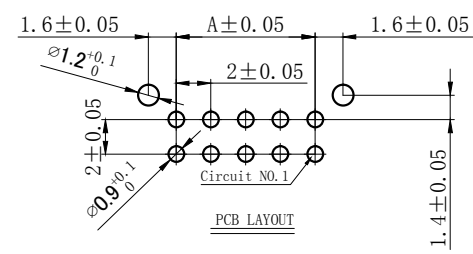

GENERAL TOLERANCES (UNLESS SPECIFIED)		ZHE JIANG DELI CONNECTORS CO., LTD	
.X: ± 0.25	X°: ± 3.0°	PRODUCT NAME: DL20034-AWD-S (PAD-AWD-S)	TITLE: 2.00 mm Pitch Wire To Board Wafer
.XX: ± 0.15	.X°: ± 2.0°	DR: Chen Quan Long	DATE:22/12/01
.XXX: ± 0.01	.XX°: ± 1.0°	CHKD: Wu Hui	DATE:22/12/01
FINISH:		APPD: Ren An De	DATE:22/12/01
DRAWING NO:		UNITS: mm	REV.: A

A

B

C

D

E

F

A

B

C

D

E

F

1 2 3 4 5 6 7 8

REV.	REVISION DESCRIPTION	DATE	APPD

NOTES

Available in 04 through 40 Circuits.
 Match with DL20034 series Wafer.
 Material : Nylon UL94V-0 (2) .
 Accepts DL20034-T Crimp Terminal.

16PIN以上

14PIN以下

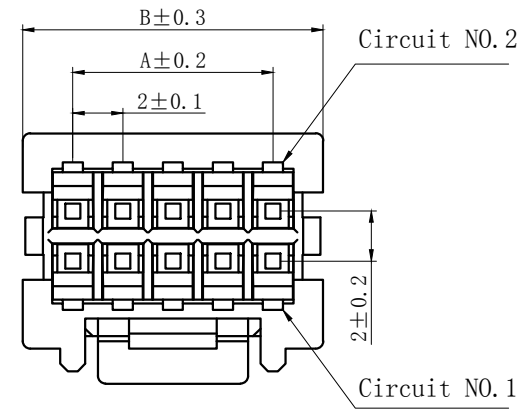
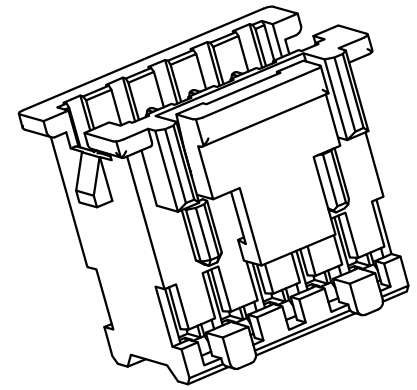
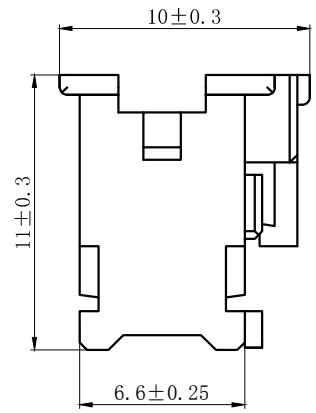
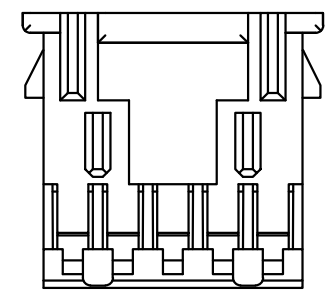
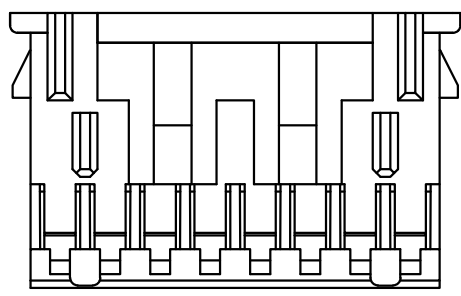

Circuits	Type	Dimensino(mm)		Circuits	Type	Dimensino(mm)	
		A	B			A	B
2X2	PAD-4Y	2.00	6.00	2X12	PAD-24Y	22.00	26.00
2X3	PAD-6Y	4.00	8.00	2X13	PAD-26Y	24.00	28.00
2X4	PAD-8Y	6.00	10.00	2X14	PAD-28Y	26.00	30.00
2X5	PAD-10Y	8.00	12.00	2X15	PAD-30Y	28.00	32.00
2X6	PAD-12Y	10.00	14.00	2X16	PAD-32Y	30.00	34.00
2X7	PAD-14Y	12.00	16.00	2X17	PAD-34Y	32.00	36.00
2X8	PAD-16Y	14.00	18.00	2X18	PAD-36Y	34.00	38.00
2X9	PAD-18Y	16.00	20.00	2X19	PAD-38Y	36.00	40.00
2X10	PAD-20Y	18.00	22.00	2X20	PAD-40Y	38.00	42.00
2X11	PAD-22Y	20.00	24.00				

GENERAL TOLERANCES (UNLESS SPECIFIED)		ZHE JIANG DELI CONNECTORS CO ., LTD	
.X: ± 0.25	X° : ± 3.0°	PRODUCT NAME: DL20034-Y (PAD-Y)	TITLE: 2.00 mm Pitch Housing
.XX: ± 0.15	.X° : ± 2.0°	DR: Chen Quan Long	DATE:22/12/01
.XXX: ± 0.01	.XX° : ± 1.0°	CHKD:Wu Hui	DATE:22/12/01
FINISH:		APPD:Ren An De	DATE:22/12/01
DRAWING NO:		SCALE: N/A	PAGE: 1/1
		UNITS: mm	REV.: A

A
B
C
D
E
F

A
B
C
D
E
F

1 2 3 4 5 6 7 8

REV.	REVISION DESCRIPTION	DATE	APPD

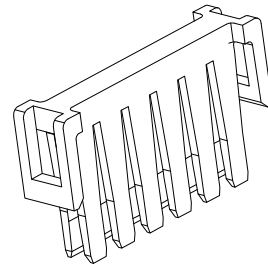
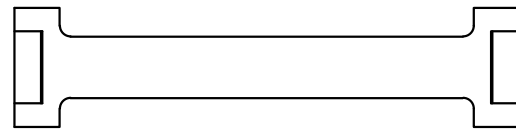
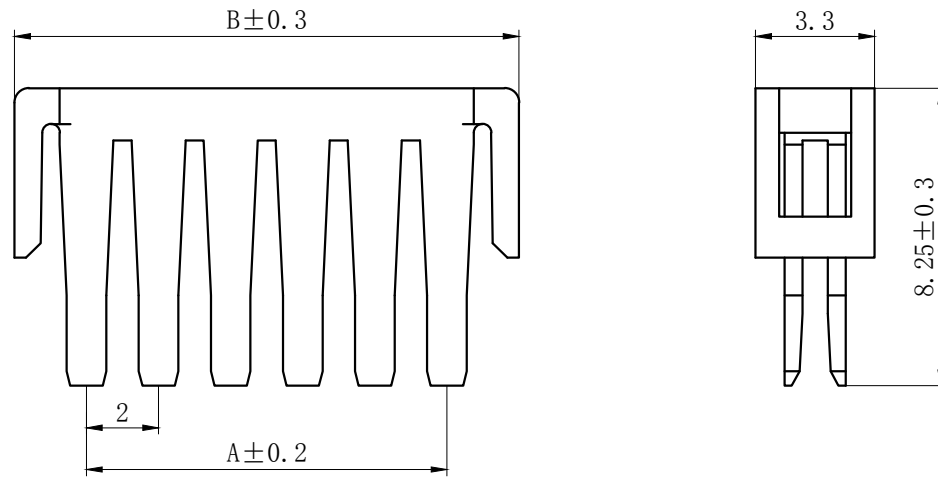

NOTES

Available in 04 through 40 Circuits.
 Mates with DL20034-Y Series Housing.
 Material : Nylon UL94V-0(2).
 Green Material RoHS Compliant.

Circuits	Type	Dimension (mm)		Circuits	Type	Dimension (mm)	
		A	B			A	B
2X2	PAD-4S	2.00	6.00	2X12	PAD-24S	22.00	26.00
2X3	PAD-6S	4.00	8.00	2X13	PAD-26S	24.00	28.00
2X4	PAD-8S	6.00	10.00	2X14	PAD-28S	26.00	30.00
2X5	PAD-10S	8.00	12.00	2X15	PAD-30S	28.00	32.00
2X6	PAD-12S	10.00	14.00	2X16	PAD-32S	30.00	34.00
2X7	PAD-14S	12.00	16.00	2X17	PAD-34S	32.00	36.00
2X8	PAD-16S	14.00	18.00	2X18	PAD-36S	34.00	38.00
2X9	PAD-18S	16.00	20.00	2X19	PAD-38S	36.00	40.00
2X10	PAD-20S	18.00	22.00	2X20	PAD-40S	38.00	42.00
2X11	PAD-22S	20.00	24.00				

GENERAL TOLERANCES (UNLESS SPECIFIED)		ZHE JIANG DELI CONNECTORS CO., LTD	
.X: ± 0.25	X° : ± 3.0°	PRODUCT NAME:	TITLE: 2.0 mm Pitch Wire To Board
.XX: ± 0.15	.X° : ± 2.0°	DL20034-S (PAD-S)	
.XXX: ± 0.01	.XX° : ± 1.0°	DR: Chen Quan Long	DATE: 19/08/01
FINISH:		CHKD: Wu Hui	DATE: 19/08/01
DRAWING NO:		APPD: Ren An De	DATE: 19/08/01
			PART NO:
			SCALE: N/A
			PAGE: 1/1
			UNITS: mm
			REV.: A

REV.	REVISION DESCRIPTION	DATE	APPD

NOTES

Used in DL20001-Y Series Housing.

Accepts AWG #28~22 Wire Range.

0.08~ 0.33 mm² .

Insulation O.D.=0.8~1.5 mm.

Material : Phosphor Bronze .

Finish: Tin plated.

Thickness: 0.2 mm.

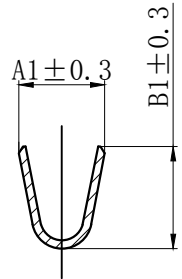
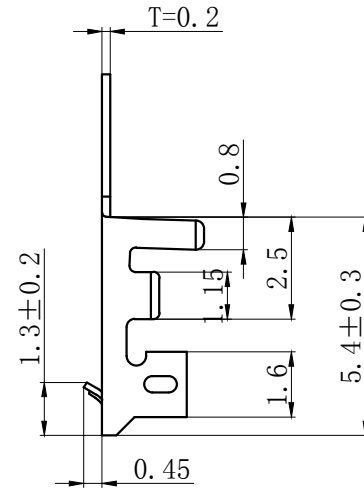
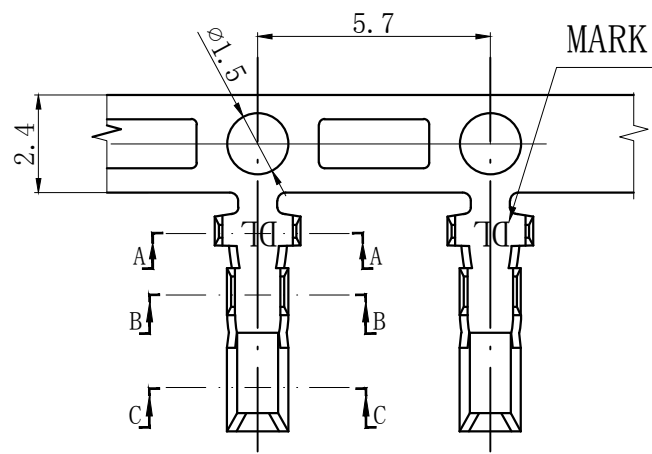

SECTION A-A

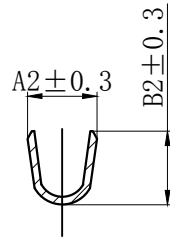

SECTION B-B

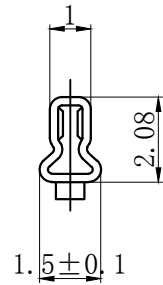

SECTION C-C

TYPE	Dimension mm				Applicable wires AWG#
	A1	B1	A2	B2	
PH-T-G	2.1	2.5	1.7	1.8	24-22
PH-T	2.1	2.5	1.5	1.4	26-24
PH-T-D	1.9	1.9	1.2	1.2	28-26

GENERAL TOLERANCES
(UNLESS SPECIFIED)

.X: ± 0.25	X° : ± 3.0°
.XX: ± 0.15	.X° : ± 2.0°
.XXX: ± 0.01	.XX° : ± 1.0°

FINISH: _____
DRAWING NO: _____

ZHE JIANG DELI CONNECTORS CO., LTD

PRODUCT NAME:
DL20001-T (PH-T)

TITLE:
2.00 mm Pitch
Crimp Terminal

DR: Chen Quan Long DATE: 20/01/26

PART NO:

CHKD: Wu Hui DATE: 20/01/26

SCALE: N/A PAGE: 1/1

APPD: Ren An De DATE: 20/01/26

UNITS: mm REV.: A

X-ON Electronics

Largest Supplier of Electrical and Electronic Components

Click to view similar products for [Headers & Wire Housings](#) category:

Click to view products by [DLL](#) manufacturer:

Other Similar products are found below :

[0015917161](#) [0022155065](#) [57102-F02-18ULF](#) [58102-G61-06LF](#) [582553-1](#) [01.001.5753.1](#) [0050291907](#) [02.125.8002.8](#) [609-3404](#) [61062-3](#)
[CSU011177004](#) [622-0430](#) [622-3653LF](#) [63453-116](#) [636-1030](#) [636-1427](#) [636-3427](#) [636-4007](#) [641938-9](#) [65495-038](#) [65692-001LF](#) [65781-018](#)
[65781-047](#) [65817-010LF](#) [65817-015LF](#) [67095-007LF](#) [67601157](#) [68631-112](#) [68645-018](#) [699319-000](#) [70.362.1628.0](#) [70-4210](#) [70-4226B](#) [70-](#)
[4853B](#) [71.350.2428.0](#) [733-134](#) [733-162](#) [MHR-64-VUAL](#) [80.063.4001.1](#) [800-90-001-10-001000](#) [801-43-002-10-013000](#) [801-43-006-10-](#)
[002000](#) [803-43-024-10-001000](#) [803-93-012-10-001000](#) [8-1437020-4](#) [819-22-004-30-001101](#) [820-22-006-30-001101](#) [820-22-008-30-001101](#)
[821-22-002-10-001101](#) [821-22-003-10-002101](#)