

技术特性/Specifications:

额定电压 Rated voltage: 250V AC, DC
额定电流 Rated current: 3A AC, DC
接触电阻 Contact resistance: 20m Ω max
绝缘电阻 Insulation resistance: 1000M Ω min
耐压 Withstand voltage: 800V AC/minute
环境温度 Ambient temperature: -40 $^{\circ}$ C~+105 $^{\circ}$ C
适用线规 Wire range: AWG#28~#22

REV.	REVISION DESCRIPTION	DATE	APPD

16PIN以上

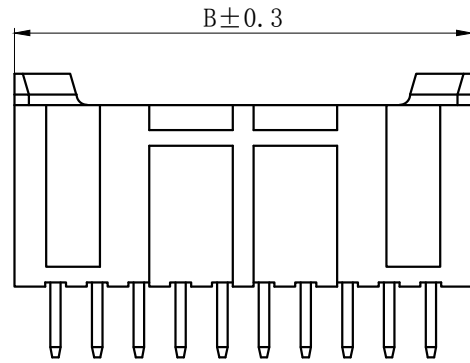

14PIN以下

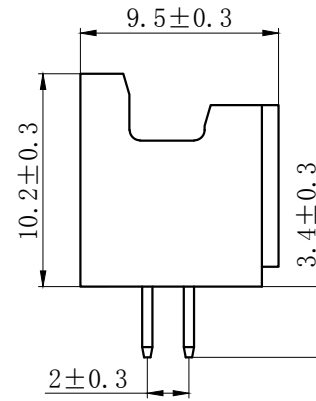
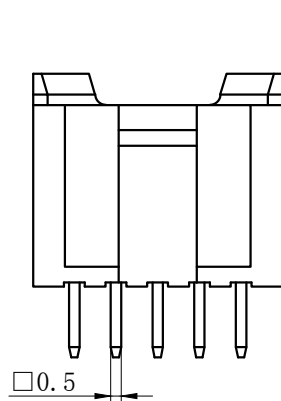

NOTES

Available in 04 through 40 Circuits.
 Mates with DL20034-Y Series Housing.
 Material : Nylon UL94V-0 (2) .
 0.50mm Square Pin.
 Pin Material : Brass / Tin-Plated.

30-40PIN

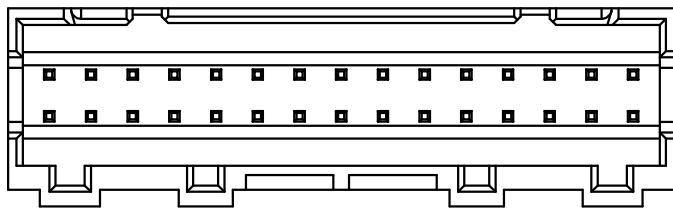

10-28PIN

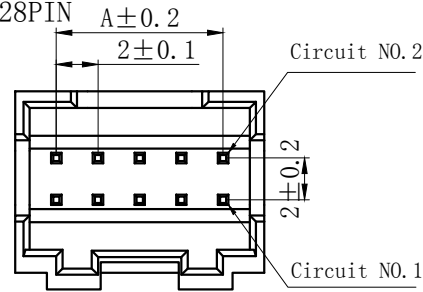

4-8PIN

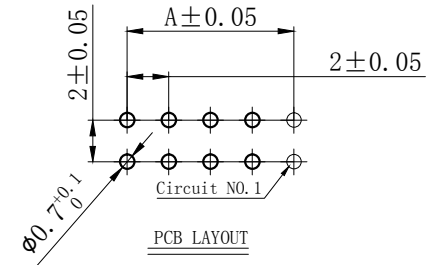
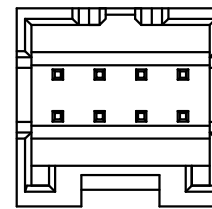

Circuits	Type	Dimensino (mm)		Circuits	Type	Dimensino (mm)	
		A	B			A	B
2X2	PAD-4A	2.00	6.00	2X12	PAD-24A	22.00	26.00
2X3	PAD-6A	4.00	8.00	2X13	PAD-26A	24.00	28.00
2X4	PAD-8A	6.00	10.00	2X14	PAD-28A	26.00	30.00
2X5	PAD-10A	8.00	12.00	2X15	PAD-30A	28.00	32.00
2X6	PAD-12A	10.00	14.00	2X16	PAD-32A	30.00	34.00
2X7	PAD-14A	12.00	16.00	2X17	PAD-34A	32.00	36.00
2X8	PAD-16A	14.00	18.00	2X18	PAD-36A	34.00	38.00
2X9	PAD-18A	16.00	20.00	2X19	PAD-38A	36.00	40.00
2X10	PAD-20A	18.00	22.00	2X20	PAD-40A	38.00	42.00
2X11	PAD-22A	20.00	24.00				

GENERAL TOLERANCES (UNLESS SPECIFIED)		ZHE JIANG DELI CONNECTORS CO., LTD	
.X: ± 0.25	X°: ± 3.0°	PRODUCT NAME: DL20034-A (PAD-A)	TITLE: 2.00 mm Pitch Wire To Board Wafer
.XX: ± 0.15	.X°: ± 2.0°	DR: Chen Quan Long	DATE: 22/12/01
.XXX: ± 0.01	.XX°: ± 1.0°	CHKD: Wu Hui	DATE: 22/12/01
FINISH:		APPD: Ren An De	DATE: 22/12/01
DRAWING NO:			
		SCALE: N/A	PAGE: 1/1
		UNITS: mm	REV.: A

REV.	7	REVISION DESCRIPTION	8	DATE	APPD

NOTES

Available in 04 through 40 Circuits.
Mates with DL20034-Y Series Housing.
Material : Nylon UL94V-0 (2) .
0.50mm Square Pin.
Pin Material : Brass / Tin-Plated.

16PIN以上

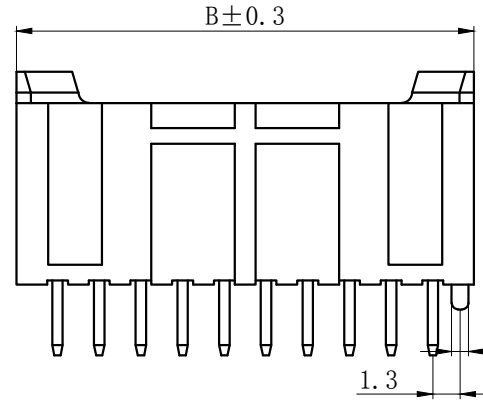

14PIN以下

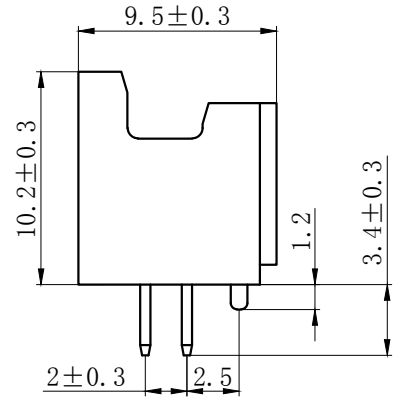
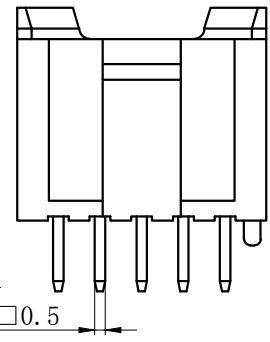

30-40PIN

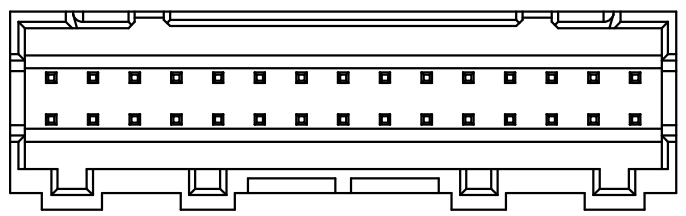

10-28PIN

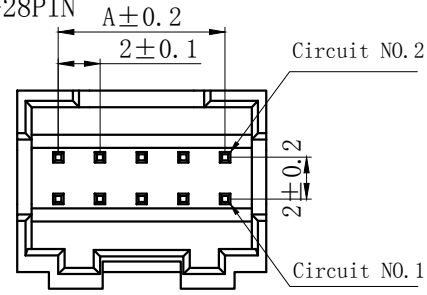

4-8PIN

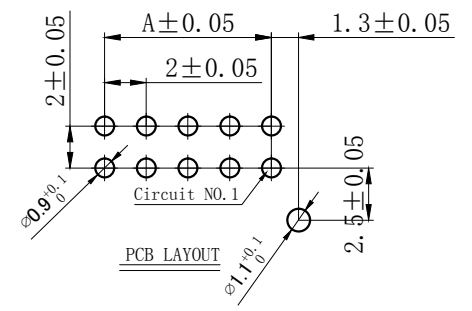
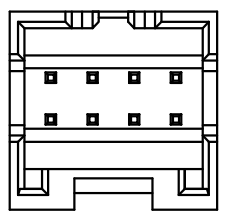

Circuits	Type	Dimensino (mm)		Circuits	Type	Dimensino (mm)	
		A	B			A	B
2X2	PAD-4AS	2.00	6.00	2X12	PAD-24AS	22.00	26.00
2X3	PAD-6AS	4.00	8.00	2X13	PAD-26AS	24.00	28.00
2X4	PAD-8AS	6.00	10.00	2X14	PAD-28AS	26.00	30.00
2X5	PAD-10AS	8.00	12.00	2X15	PAD-30AS	28.00	32.00
2X6	PAD-12AS	10.00	14.00	2X16	PAD-32AS	30.00	34.00
2X7	PAD-14AS	12.00	16.00	2X17	PAD-34AS	32.00	36.00
2X8	PAD-16AS	14.00	18.00	2X18	PAD-36AS	34.00	38.00
2X9	PAD-18AS	16.00	20.00	2X19	PAD-38AS	36.00	40.00
2X10	PAD-20AS	18.00	22.00	2X20	PAD-40AS	38.00	42.00
2X11	PAD-22AS	20.00	24.00				

GENERAL TOLERANCES (UNLESS SPECIFIED)		ZHE JIANG DELI CONNECTORS CO., LTD	
.X: ± 0.25	X° : ± 3.0°	PRODUCT NAME: DL20034-AS (PAD-AS)	TITLE: 2.00 mm Pitch Wire To Board Wafer
.XX: ± 0.15	.X° : ± 2.0°	DR: Chen Quan Long	DATE:22/12/01
.XXX: ± 0.01	.XX° : ± 1.0°	CHKD: Wu Hui	DATE:22/12/01
FINISH:		APPD: Ren An De	DATE:22/12/01
DRAWING NO:		UNITS: mm	REV.: A

REV.	REVISION DESCRIPTION	DATE	APPD

16PIN以上

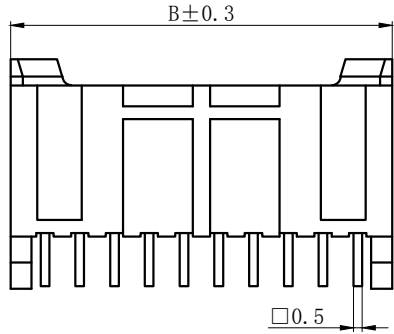

14PIN以下

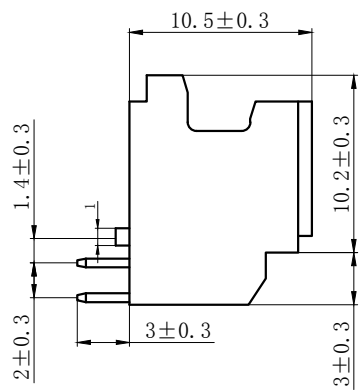
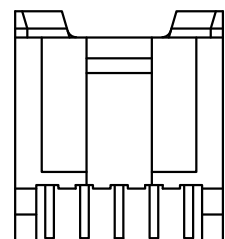

NOTES

Available in 04 through 40 Circuits.
 Mates with DL20034-Y Series Housing.
 Material : Nylon UL94V-0 (2) .
 0.50mm Square Pin.
 Pin Material : Brass / Tin-Plated.

30-40PIN

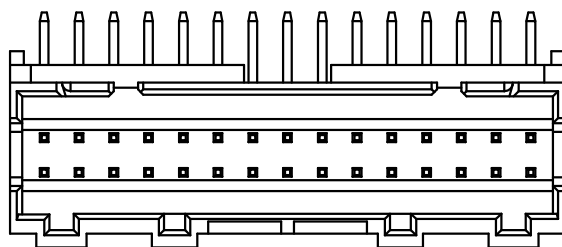

10-28PIN

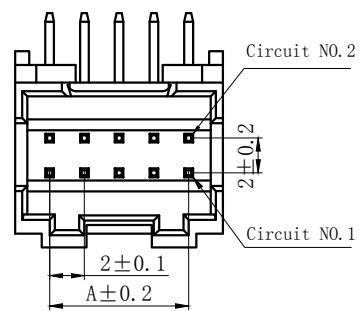

4-8PIN

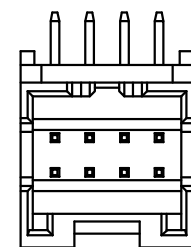

Circuits	Type	Dimensino(mm)		Circuits	Type	Dimensino(mm)	
		A	B			A	B
2X2	PAD-4AWD-S	2.00	6.00	2X12	PAD-24AWD-S	22.00	26.00
2X3	PAD-6AWD-S	4.00	8.00	2X13	PAD-26AWD-S	24.00	28.00
2X4	PAD-8AWD-S	6.00	10.00	2X14	PAD-28AWD-S	26.00	30.00
2X5	PAD-10AWD-S	8.00	12.00	2X15	PAD-30AWD-S	28.00	32.00
2X6	PAD-12AWD-S	10.00	14.00	2X16	PAD-32AWD-S	30.00	34.00
2X7	PAD-14AWD-S	12.00	16.00	2X17	PAD-34AWD-S	32.00	36.00
2X8	PAD-16AWD-S	14.00	18.00	2X18	PAD-36AWD-S	34.00	38.00
2X9	PAD-18AWD-S	16.00	20.00	2X19	PAD-38AWD-S	36.00	40.00
2X10	PAD-20AWD-S	18.00	22.00	2X20	PAD-40AWD-S	38.00	42.00
2X11	PAD-22AWD-S	20.00	24.00				

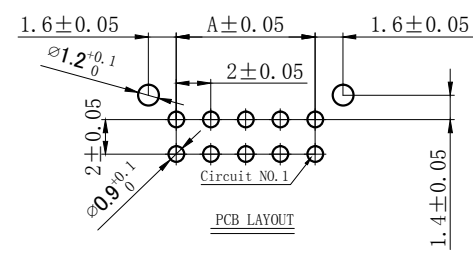

GENERAL TOLERANCES (UNLESS SPECIFIED)		ZHE JIANG DELI CONNECTORS CO., LTD	
.X: ± 0.25	X°: ± 3.0°	PRODUCT NAME: DL20034-AWD-S (PAD-AWD-S)	TITLE: 2.00 mm Pitch Wire To Board Wafer
.XX: ± 0.15	.X°: ± 2.0°	DR: Chen Quan Long	DATE:22/12/01
.XXX: ± 0.01	.XX°: ± 1.0°	CHKD: Wu Hui	DATE:22/12/01
FINISH:		APPD: Ren An De	DATE:22/12/01
DRAWING NO:		UNITS: mm	REV.: A
		PART NO:	SCALE: N/A
			PAGE: 1/1

REV.	REVISION DESCRIPTION	DATE	APPD

NOTES

Available in 04 through 40 Circuits.
 Match with DL20034 series Wafer.
 Material : Nylon UL94V-0 (2) .
 Accepts DL20034-T Crimp Terminal.

16PIN以上

14PIN以下

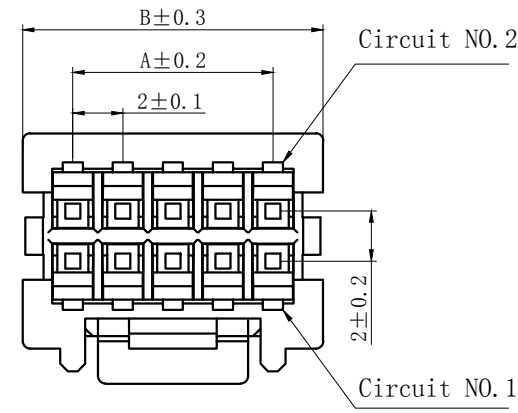
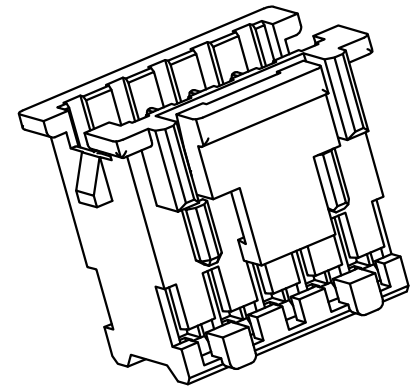
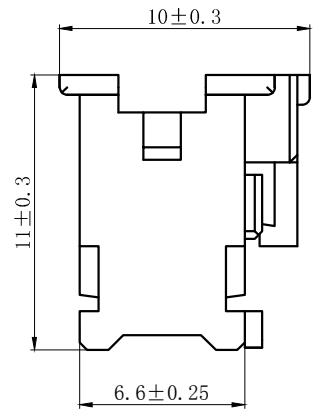
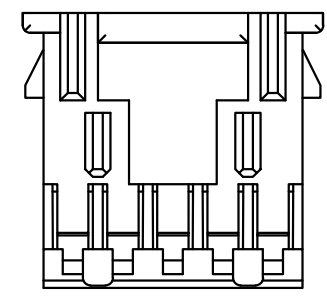
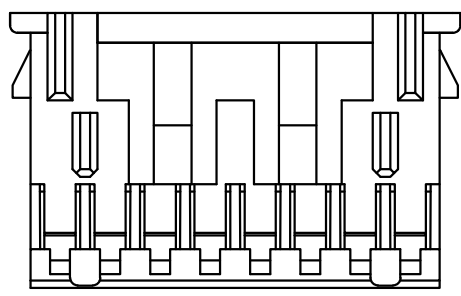

Circuits	Type	Dimensino(mm)		Circuits	Type	Dimensino(mm)	
		A	B			A	B
2X2	PAD-4Y	2.00	6.00	2X12	PAD-24Y	22.00	26.00
2X3	PAD-6Y	4.00	8.00	2X13	PAD-26Y	24.00	28.00
2X4	PAD-8Y	6.00	10.00	2X14	PAD-28Y	26.00	30.00
2X5	PAD-10Y	8.00	12.00	2X15	PAD-30Y	28.00	32.00
2X6	PAD-12Y	10.00	14.00	2X16	PAD-32Y	30.00	34.00
2X7	PAD-14Y	12.00	16.00	2X17	PAD-34Y	32.00	36.00
2X8	PAD-16Y	14.00	18.00	2X18	PAD-36Y	34.00	38.00
2X9	PAD-18Y	16.00	20.00	2X19	PAD-38Y	36.00	40.00
2X10	PAD-20Y	18.00	22.00	2X20	PAD-40Y	38.00	42.00
2X11	PAD-22Y	20.00	24.00				

GENERAL TOLERANCES (UNLESS SPECIFIED)		ZHE JIANG DELI CONNECTORS CO ., LTD	
.X: ± 0.25	X° : ± 3.0°	PRODUCT NAME: DL20034-Y (PAD-Y)	TITLE: 2.00 mm Pitch Housing
.XX: ± 0.15	.X° : ± 2.0°	DR: Chen Quan Long	DATE:22/12/01
.XXX: ± 0.01	.XX° : ± 1.0°	CHKD:Wu Hui	DATE:22/12/01
FINISH:		APPD:Ren An De	DATE:22/12/01
DRAWING NO:		SCALE: N/A	PAGE: 1/1
		UNITS: mm	REV.: A

A
B
C
D
E
F

A
B
C
D
E
F

1 2 3 4 5 6 7 8

REV.	REVISION DESCRIPTION	DATE	APPD

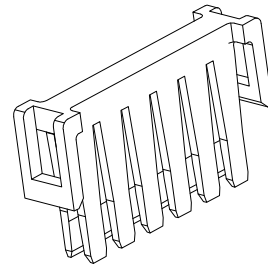
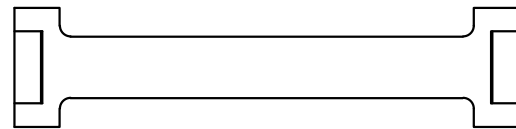
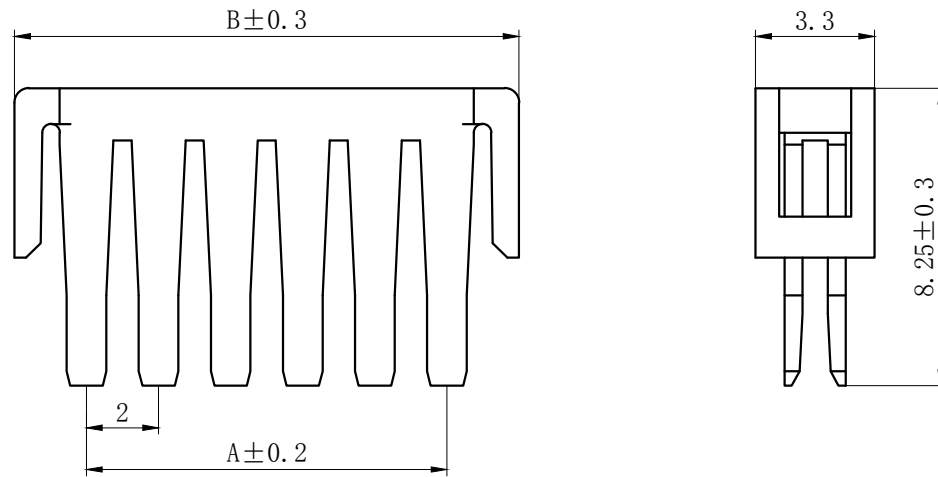

NOTES

Available in 04 through 40 Circuits.
Mates with DL20034-Y Series Housing.
Material : Nylon UL94V-0(2).
Green Material RoHS Compliant.

Circuits	Type	Dimension (mm)		Circuits	Type	Dimension (mm)	
		A	B			A	B
2X2	PAD-4S	2.00	6.00	2X12	PAD-24S	22.00	26.00
2X3	PAD-6S	4.00	8.00	2X13	PAD-26S	24.00	28.00
2X4	PAD-8S	6.00	10.00	2X14	PAD-28S	26.00	30.00
2X5	PAD-10S	8.00	12.00	2X15	PAD-30S	28.00	32.00
2X6	PAD-12S	10.00	14.00	2X16	PAD-32S	30.00	34.00
2X7	PAD-14S	12.00	16.00	2X17	PAD-34S	32.00	36.00
2X8	PAD-16S	14.00	18.00	2X18	PAD-36S	34.00	38.00
2X9	PAD-18S	16.00	20.00	2X19	PAD-38S	36.00	40.00
2X10	PAD-20S	18.00	22.00	2X20	PAD-40S	38.00	42.00
2X11	PAD-22S	20.00	24.00				

GENERAL TOLERANCES (UNLESS SPECIFIED)				ZHE JIANG DELI CONNECTORS CO., LTD			
.X: ± 0.25	X°: ± 3.0°	PRODUCT NAME: DL20034-S (PAD-S)		TITLE: 2.0 mm Pitch Wire To Board			
.XX: ± 0.15	.X°: ± 2.0°	DR: Chen Quan Long		DATE: 19/08/01		PART NO:	
.XXX: ± 0.01	.XX°: ± 1.0°	CHKD: Wu Hui		DATE: 19/08/01		SCALE: N/A	
FINISH:		APPD: Ren An De		DATE: 19/08/01		PAGE: 1/1	
DRAWING NO:				UNITS: mm		REV.: A	

REV.	REVISION DESCRIPTION	DATE	APPD

NOTES

Used in DL20001-Y Series Housing.

Accepts AWG #28~22 Wire Range.

0.08~ 0.33 mm².

Insulation O.D.=0.8~1.5 mm.

Material : Phosphor Bronze .

Finish: Tin plated.

Thickness: 0.2 mm.

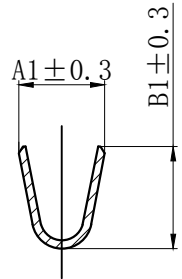
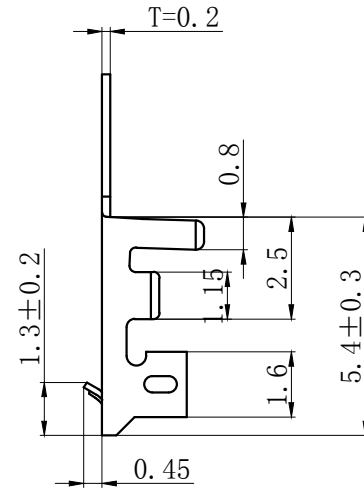
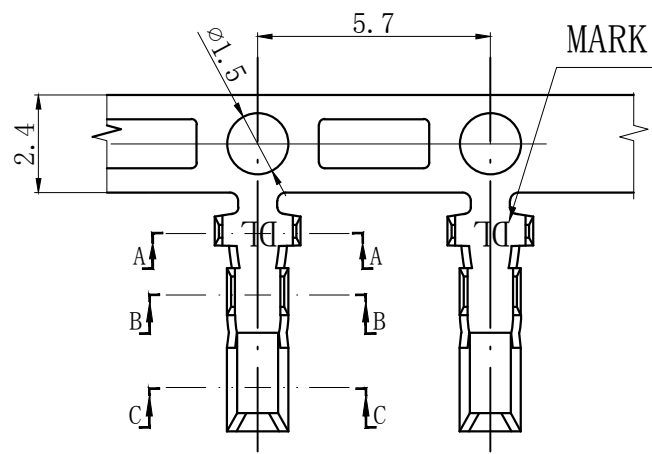

SECTION A-A

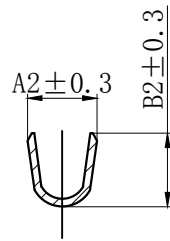

SECTION B-B

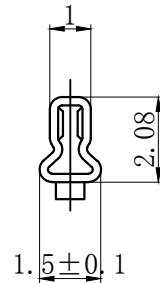

SECTION C-C

TYPE	Dimension mm				Applicable wires AWG#
	A1	B1	A2	B2	
PH-T-G	2.1	2.5	1.7	1.8	24-22
PH-T	2.1	2.5	1.5	1.4	26-24
PH-T-D	1.9	1.9	1.2	1.2	28-26

GENERAL TOLERANCES
(UNLESS SPECIFIED)

.X: ± 0.25	X° : ± 3.0°
.XX: ± 0.15	.X° : ± 2.0°
.XXX: ± 0.01	.XX° : ± 1.0°
FINISH:	
DRAWING NO:	

ZHE JIANG DELI CONNECTORS CO., LTD

PRODUCT NAME: DL20001-T (PH-T)		TITLE: 2.00 mm Pitch Crimp Terminal	
DR:Chen Quan Long	DATE:20/01/26	PART NO:	
CHKD: Wu Hui	DATE:20/01/26	SCALE: N/A	PAGE: 1/1
APPD:Ren An De	DATE:20/01/26	UNITS: mm	REV.: A

X-ON Electronics

Largest Supplier of Electrical and Electronic Components

Click to view similar products for [RF Connector Accessories](#) category:

Click to view products by [DLL](#) manufacturer:

Other Similar products are found below :

[89674-0712](#) [FERRULE-174](#) [R141802000](#) [R141842000](#) [R141862000W](#) [R280907000](#) [RFI75-3](#) [AX102907](#) [HP-500](#) [2098-3251-94](#) [KA-81-02](#)
[KA-81-05](#) [KN-89-12](#) [89674-0805](#) [FERRULE-223](#) [202102-11](#) [R280468000](#) [R280510000](#) [RFI155-1](#) [RFI25-12-D3](#) [RFI25-4-D2](#) [RFI25-5](#)
[RFI75-12-D2](#) [RFI97-14](#) [360HS001M2508M6](#) [4-1532137-4](#) [HRM-514S\(40\)](#) [5-21085-0](#) [111062-0490](#) [112122-SOD-LUG](#) [IPP-2014](#) [RFI95-](#)
[14-D2](#) [MX-913/U\(45\)](#) [1736-1511-075](#) [000-78400](#) [RFI75-2-D3](#) [RFI25-3-D3](#) [R280469010](#) [RFI85-4](#) [896110450](#) [660-024M09S5-01](#) [1403137-](#)
[1](#) [360HB001M2512H](#) [360HS001M1716M3](#) [380HS115M2508H3](#) [380HS001M1716M4](#) [FERRULE-316DB](#) [105274-2000](#) [73415-1970](#)
[R280755050W](#)