



技术特性/Specifications:

额定电压 Rated voltage: 250V AC, DC
额定电流 Rated current: 2A AC, DC
接触电阻 Contact resistance: 20mΩ max
绝缘电阻 Insulation resistance: 1000MΩ min
耐压 Withstand voltage: 800V AC/minute
环境温度 Ambient temperature: -40℃~+105℃
适用线规 Wire range: AWG#28~#22

| REV. | REVISION DESCRIPTION | DATE | APPD |
|------|----------------------|------|------|
| | | | |

NOTES

Available in 04 through 60 Circuits.
 Mates with DL20006-XXY Series Housing.
 Material : LCP UL94V-0.
 Pin Material : Brass.Tin-plated .



PCB LAYOUT



| Circuits | Product name | Dimension mm | | | Circuits | Product name | Dimension mm | | |
|----------|--------------|--------------|-------|-------|----------|--------------|--------------|-------|-------|
| | | A | B | C | | | A | B | C |
| 2X2 | PHB-4AB | 2.00 | 9.00 | 5.00 | 2X11 | PHB-22AB | 20.00 | 27.00 | 23.00 |
| 2X3 | PHB-6AB | 4.00 | 11.00 | 7.00 | 2X12 | PHB-24AB | 22.00 | 29.00 | 25.00 |
| 2X4 | PHB-8AB | 6.00 | 13.00 | 9.00 | 2X13 | PHB-26AB | 24.00 | 31.00 | 27.00 |
| 2X5 | PHB-10AB | 8.00 | 15.00 | 11.00 | 2X14 | PHB-28AB | 26.00 | 33.00 | 29.00 |
| 2X6 | PHB-12AB | 10.00 | 17.00 | 13.00 | 2X15 | PHB-30AB | 28.00 | 35.00 | 31.00 |
| 2X7 | PHB-14AB | 12.00 | 19.00 | 15.00 | 2X16 | PHB-32AB | 30.00 | 37.00 | 33.00 |
| 2X8 | PHB-16AB | 14.00 | 21.00 | 17.00 | 2X17 | PHB-34AB | 32.00 | 39.00 | 35.00 |
| 2X9 | PHB-18AB | 16.00 | 23.00 | 19.00 | - | - | - | - | - |
| 2X10 | PHB-20AB | 18.00 | 25.00 | 21.00 | 2X30 | PHB-60AB | 58.00 | 65.00 | 61.00 |

| | | | | | |
|----|----|-----|-----|----|---------|
| 3 | ③ | 基座 | LCP | 1 | UL94V-0 |
| 2 | ② | 焊片 | 黄铜 | 2 | 镀锡 |
| 1 | ① | 接触件 | 黄铜 | N* | 镀锡 |
| 序号 | 图号 | 名称 | 材料 | 数量 | 附件 |

| GENERAL TOLERANCES (UNLESS SPECIFIED) | | ZHE JIANG DELI CONNECTORS CO., LTD | | | |
|---------------------------------------|--------------|---|--|---|--|
| .X: ± 0.25 | X°: ± 3.0° | PRODUCT NAME: DL20006 (PHB) -AB | | TITLE: 2.0 mm Pitch Wire To Board SMT Wafer | |
| .XX: ± 0.15 | .X°: ± 2.0° | DR: Chen Quan Long DATE: 20/09/03 | | PART NO: | |
| .XXX: ± 0.01 | .XX°: ± 1.0° | CHKD: Wu Hui DATE: 20/09/03 | | SCALE: N/A PAGE: 1/1 | |
| FINISH: | | APPD: Ren An De DATE: 20/09/03 | | UNITS: mm REV.: A | |
| DRAWING NO: | | | | | |

| REV. | REVISION DESCRIPTION | DATE | APPD |
|------|----------------------|------|------|
| | | | |

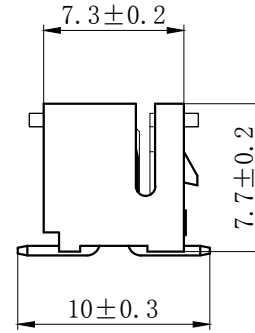
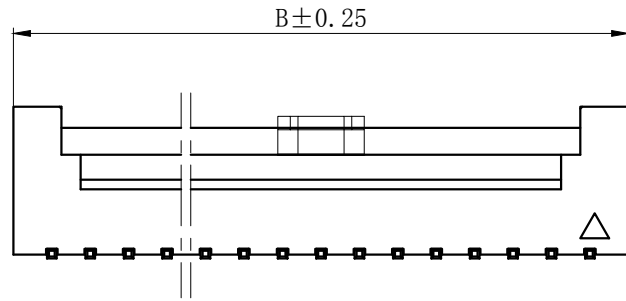

NOTES

Available in 04 through 60 Circuits.
 Mates with DL20006-Y Series Housing.
 Material : LCP UL94V-0.
 0.50mm Square Pin.
 Pin Material : Brass / Tin-Plated.

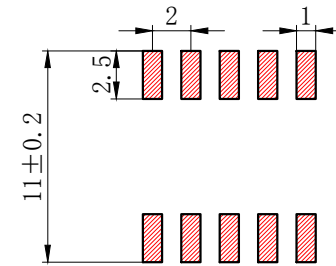
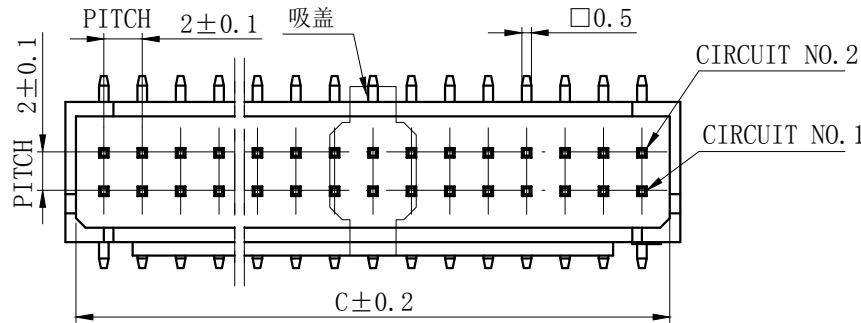

PCB LAYOUT

| Circuits | Product name | Dimension mm | | | Circuits | Product name | Dimension mm | | | Circuits | Product name | Dimension mm | | |
|----------|--------------|--------------|-------|-------|----------|--------------|--------------|-------|-------|----------|--------------|--------------|-------|-------|
| | | A | B | C | | | A | B | C | | | A | B | C |
| 2X2 | PHB-4ABZ | 2.00 | 6.00 | 4.90 | 2X10 | PHB-20ABZ | 18.00 | 22.00 | 20.90 | 2X18 | PHB-36ABZ | 34.00 | 38.00 | 36.90 |
| 2X3 | PHB-6ABZ | 4.00 | 8.00 | 6.90 | 2X11 | PHB-22ABZ | 20.00 | 24.00 | 22.90 | 2X19 | PHB-38ABZ | 36.00 | 40.00 | 38.90 |
| 2X4 | PHB-8ABZ | 6.00 | 10.00 | 8.90 | 2X12 | PHB-24ABZ | 22.00 | 26.00 | 24.90 | 2X20 | PHB-40ABZ | 38.00 | 42.00 | 40.90 |
| 2X5 | PHB-10ABZ | 8.00 | 12.00 | 10.90 | 2X13 | PHB-26ABZ | 24.00 | 28.00 | 26.90 | ~ | ~ | ~ | ~ | ~ |
| 2X6 | PHB-12ABZ | 10.00 | 14.00 | 12.90 | 2X14 | PHB-28ABZ | 26.00 | 30.00 | 28.90 | 2X30 | PHB-60ABZ | 58.00 | 62.00 | 60.90 |
| 2X7 | PHB-14ABZ | 12.00 | 16.00 | 14.90 | 2X15 | PHB-30ABZ | 28.00 | 32.00 | 30.90 | | | | | |
| 2X8 | PHB-16ABZ | 14.00 | 18.00 | 16.90 | 2X16 | PHB-32ABZ | 30.00 | 34.00 | 32.90 | | | | | |
| 2X9 | PHB-18ABZ | 16.00 | 20.00 | 18.90 | 2X17 | PHB-34ABZ | 32.00 | 36.00 | 34.90 | | | | | |

| GENERAL TOLERANCES (UNLESS SPECIFIED) | | ZHE JIANG DELI CONNECTORS CO., LTD | |
|--|--------------|------------------------------------|---|
| .X: ± 0.25 | X°: ± 3.0° | PRODUCT NAME: | TITLE: 2.00 mm Pitch Wire To Board Wafer |
| .XX: ± 0.15 | .X°: ± 2.0° | DL20006 (PHB)-ABZ | |
| .XXX: ± 0.01 | .XX°: ± 1.0° | DR: Chen Quan Long | DATE: 21.7.16 |
| FINISH: | | CHKD: Wu Hui | DATE: 21.7.16 |
| DRAWING NO: | | APPD: Ren An De | DATE: 21.7.16 |
| | | | SCALE: N/A |
| | | | PAGE: 1/1 |
| | | | UNITS: mm |
| | | | REV.: A |

| | | | |
|------|----------------------|------|------|
| REV. | REVISION DESCRIPTION | DATE | APPD |
| | | | |



NOTES

Available in 04 through 60 Circuits.
 Mates with DL20006-XXY Series Housing.
 Material : LCP UL94V-0.
 Pin Material : Brass. Tin-plated .

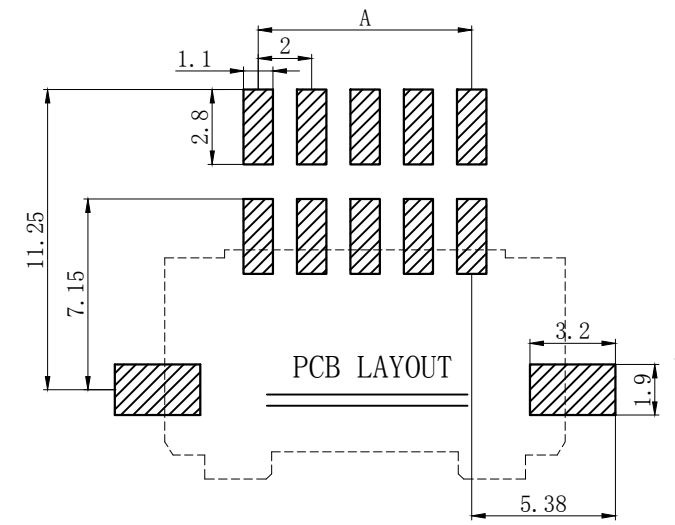

| Type | Product name | Dimension mm | | | Type | Product name | Dimension mm | | |
|------|--------------|--------------|-------|-------|------|--------------|--------------|-------|-------|
| | | A | B | C | | | A | B | C |
| 2X2 | PHB-4AWB | 2.00 | 9.00 | 5.00 | 2X11 | PHB-22AWB | 20.00 | 27.00 | 23.00 |
| 2X3 | PHB-6AWB | 4.00 | 11.00 | 7.00 | 2X12 | PHB-24AWB | 22.00 | 29.00 | 25.00 |
| 2X4 | PHB-8AWB | 6.00 | 13.00 | 9.00 | 2X13 | PHB-26AWB | 24.00 | 31.00 | 27.00 |
| 2X5 | PHB-10AWB | 8.00 | 15.00 | 11.00 | 2X14 | PHB-28AWB | 26.00 | 33.00 | 29.00 |
| 2X6 | PHB-12AWB | 10.00 | 17.00 | 13.00 | 2X15 | PHB-32AWB | 28.00 | 35.00 | 31.00 |
| 2X7 | PHB-14AWB | 12.00 | 19.00 | 15.00 | 2X16 | PHB-32AWB | 30.00 | 37.00 | 33.00 |
| 2X8 | PHB-16AWB | 14.00 | 21.00 | 17.00 | 2X17 | PHB-34AWB | 32.00 | 39.00 | 35.00 |
| 2X9 | PHB-18AWB | 16.00 | 23.00 | 19.00 | - | - | - | - | - |
| 2X10 | PHB-20AWB | 18.00 | 25.00 | 21.00 | 2X30 | PHB-60AWB | 58.00 | 65.00 | 61.00 |

| | | | | | |
|----|----|-----|-----|----|---------|
| 3 | ③ | 基座 | LCP | 1 | UL94V-0 |
| 2 | ② | 焊片 | 黄铜 | 2 | 镀锡 |
| 1 | ① | 接触件 | 黄铜 | N* | 镀锡 |
| 序号 | 图号 | 名称 | 材料 | 数量 | 附件 |

| | | | | | |
|---------------------------------------|--------------|------------------------------------|----------------|---|-----------|
| GENERAL TOLERANCES (UNLESS SPECIFIED) | | ZHE JIANG DELI CONNECTORS CO., LTD | | | |
| .X: ± 0.25 | X°: ± 3.0° | PRODUCT NAME: DL20006 (PHB)-AWB | | TITLE: 2.0 mm Pitch Wire To Board SMT Wafer | |
| .XX: ± 0.15 | .X°: ± 2.0° | DR: Chen Quan Long | | DATE: 20/09/03 | |
| .XXX: ± 0.01 | .XX°: ± 1.0° | FINISH: _____ | | PART NO: | |
| DRAWING NO: _____ | | CHKD: Wu Hui | DATE: 20/09/03 | SCALE: N/A | PAGE: 1/1 |
| | | APPD: Ren An De | DATE: 20/09/03 | UNITS: mm | REV.: A |

| | | | |
|------|----------------------|------|------|
| REV. | REVISION DESCRIPTION | DATE | APPD |
| A | 3.4调整3.3±0.2 | | LIU |

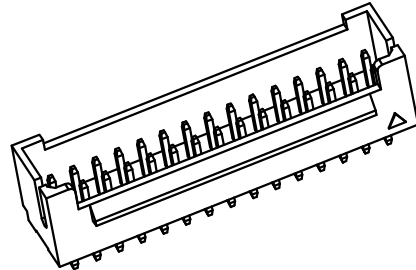
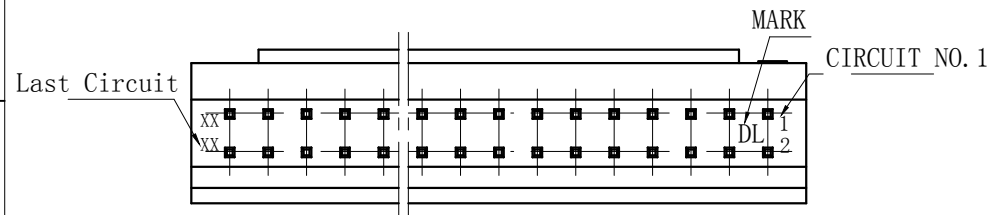

NOTES

Available in 04 through 60 Circuits.
 Mates with DL20006-Y Series Housing.
 Material : Nylon UL94V-0(2).
 0.50mm Square Pin.
 Pin Material : Brass / Tin-Plated.

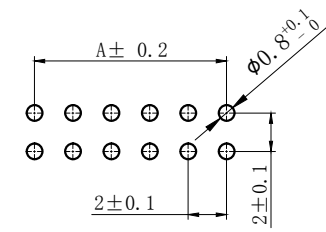
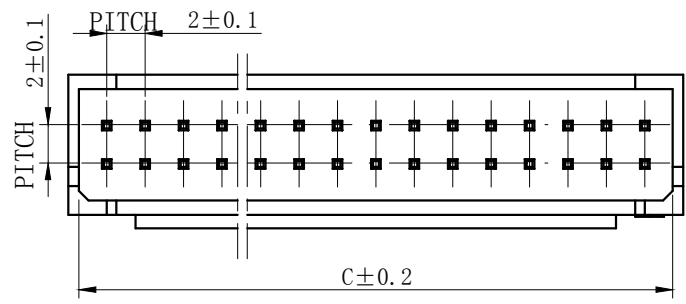
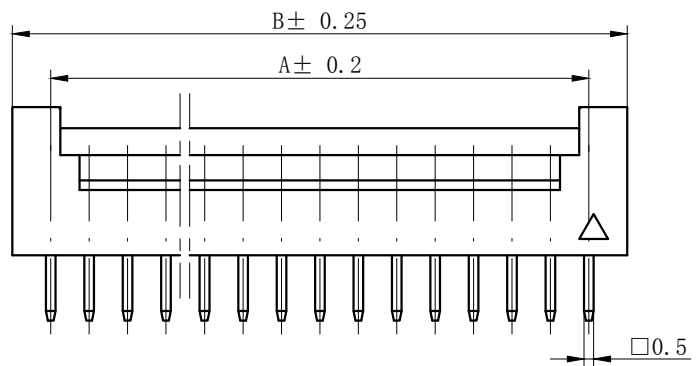

PCB LAYOUT

| Circuits | Product name | Dimension mm | | | Circuits | Product name | Dimension mm | | | Circuits | Product name | Dimension mm | | |
|----------|--------------|--------------|-------|-------|----------|--------------|--------------|-------|-------|----------|--------------|--------------|-------|-------|
| | | A | B | C | | | A | B | C | | | A | B | C |
| 2X2 | PHB-4A | 2.00 | 6.00 | 4.90 | 2X10 | PHB-20A | 18.00 | 22.00 | 20.90 | 2X18 | PHB-36A | 34.00 | 38.00 | 36.90 |
| 2X3 | PHB-6A | 4.00 | 8.00 | 6.90 | 2X11 | PHB-22A | 20.00 | 24.00 | 22.90 | 2X19 | PHB-38A | 36.00 | 40.00 | 38.90 |
| 2X4 | PHB-8A | 6.00 | 10.00 | 8.90 | 2X12 | PHB-24A | 22.00 | 26.00 | 24.90 | 2X20 | PHB-40A | 38.00 | 42.00 | 40.90 |
| 2X5 | PHB-10A | 8.00 | 12.00 | 10.90 | 2X13 | PHB-26A | 24.00 | 28.00 | 26.90 | ~ | ~ | ~ | ~ | ~ |
| 2X6 | PHB-12A | 10.00 | 14.00 | 12.90 | 2X14 | PHB-28A | 26.00 | 30.00 | 28.90 | 2X30 | PHB-60A | 58.00 | 62.00 | 60.90 |
| 2X7 | PHB-14A | 12.00 | 16.00 | 14.90 | 2X15 | PHB-30A | 28.00 | 32.00 | 30.90 | | | | | |
| 2X8 | PHB-16A | 14.00 | 18.00 | 16.90 | 2X16 | PHB-32A | 30.00 | 34.00 | 32.90 | | | | | |
| 2X9 | PHB-18A | 16.00 | 20.00 | 18.90 | 2X17 | PHB-34A | 32.00 | 36.00 | 34.90 | | | | | |

| | | | |
|--|--------------|---|--|
| GENERAL TOLERANCES (UNLESS SPECIFIED) | | 浙江德利接插件有限公司 ZHEJIANG DELI CONNECTORS CO.,LTD | |
| .X: ± 0.25 | X°: ± 3.0° | | |
| .XX: ± 0.15 | .X°: ± 2.0° | PRODUCT NAME: DL20006 (PHB)-A | TITLE: 2.00 mm Pitch Wire To Board Wafer |
| .XXX: ± 0.01 | .XX°: ± 1.0° | DR: Yuan Jun Rong | DATE:20.11.30 |
| FINISH: _____ | | CHKD: Wu Hui | DATE:20.11.30 |
| | | APPD:Ren An De | DATE:20.11.30 |
| DRAWING NO: | | SCALE: N/A | PAGE: 1/1 |
| | | UNITS: mm | REV.: A |

| | | | |
|------|----------------------|------|------|
| REV. | REVISION DESCRIPTION | DATE | APPD |
| | | | |

NOTES

Available in 04 through 60 Circuits.
Mates with DL20006-Y Series Housing.
Material : Nylon UL94V-0(2).
0.50mm Square Pin.
Pin Material : Brass / Tin-Plated.

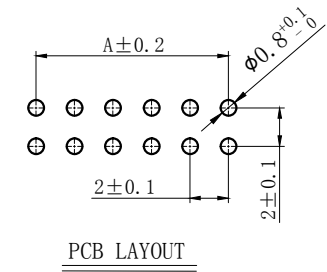
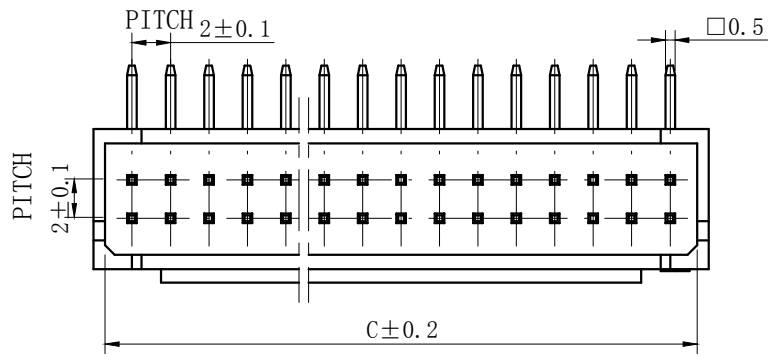

| Circuits | Product name | Dimension mm | | | Circuits | Product name | Dimension mm | | | Circuits | Product name | Dimension mm | | |
|----------|--------------|--------------|-------|-------|----------|--------------|--------------|-------|-------|----------|--------------|--------------|-------|-------|
| | | A | B | C | | | A | B | C | | | A | B | C |
| 2X2 | PHB-4AW | 2.00 | 6.00 | 4.90 | 2X10 | PHB-20AW | 18.00 | 22.00 | 20.90 | 2X18 | PHB-36AW | 34.00 | 38.00 | 36.90 |
| 2X3 | PHB-6AW | 4.00 | 8.00 | 6.90 | 2X11 | PHB-22AW | 20.00 | 24.00 | 22.90 | 2X19 | PHB-38AW | 36.00 | 40.00 | 38.90 |
| 2X4 | PHB-8AW | 6.00 | 10.00 | 8.90 | 2X12 | PHB-24AW | 22.00 | 26.00 | 24.90 | 2X20 | PHB-40AW | 38.00 | 42.00 | 40.90 |
| 2X5 | PHB-10AW | 8.00 | 12.00 | 10.90 | 2X13 | PHB-26AW | 24.00 | 28.00 | 26.90 | ~ | ~ | ~ | ~ | ~ |
| 2X6 | PHB-12AW | 10.00 | 14.00 | 12.90 | 2X14 | PHB-28AW | 26.00 | 30.00 | 28.90 | 2X30 | PHB-60AW | 58.00 | 62.00 | 60.90 |
| 2X7 | PHB-14AW | 12.00 | 16.00 | 14.90 | 2X15 | PHB-30AW | 28.00 | 32.00 | 30.90 | | | | | |
| 2X8 | PHB-16AW | 14.00 | 18.00 | 16.90 | 2X16 | PHB-32AW | 30.00 | 34.00 | 32.90 | | | | | |
| 2X9 | PHB-18AW | 16.00 | 20.00 | 18.90 | 2X17 | PHB-34AW | 32.00 | 36.00 | 34.90 | | | | | |

| | | | |
|--|---------------|--|--|
| GENERAL TOLERANCES (UNLESS SPECIFIED) | | 浙江德利接插件有限公司 ZHE JIANG DELI CONNECTORS CO.,LTD | |
| .X: ± 0.25 | X° : ± 3.0° | PRODUCT NAME: DL20006 (PHB)-AW | TITLE: 2.00 mm Pitch Wire To Board Wafer |
| .XX: ± 0.15 | .X° : ± 2.0° | DR:Chen Quan Long | DATE:20.11.30 |
| .XXX: ± 0.01 | .XX° : ± 1.0° | CHKD: Wu Hui | DATE:20.11.30 |
| DRAWING NO: | | APPD:Ren An De | DATE:20.11.30 |
| | | SCALE: N/A | PAGE: 1/1 |
| | | UNITS: mm | REV.: A |

| | | | |
|------|----------------------|------|------|
| REV. | REVISION DESCRIPTION | DATE | APPD |
| | | | |

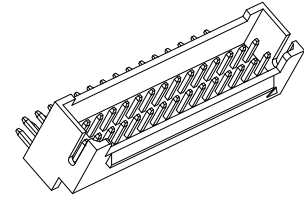
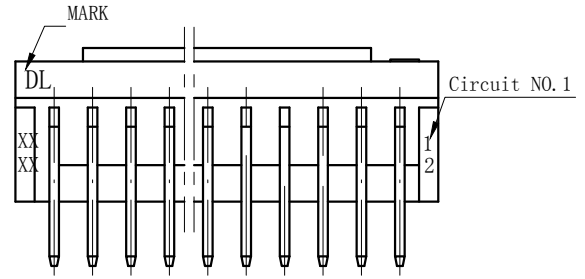

NOTES

Available in 04 through 60 Circuits.
 Mates with DL20006-Y Series Housing.
 Material : Nylon UL94V-0(2).
 0.50mm Square Pin.
 Pin Material : Brass / Tin-Plated.

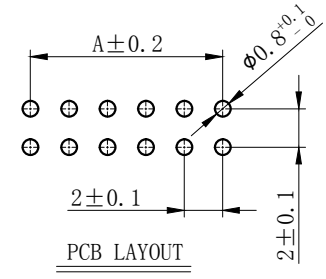
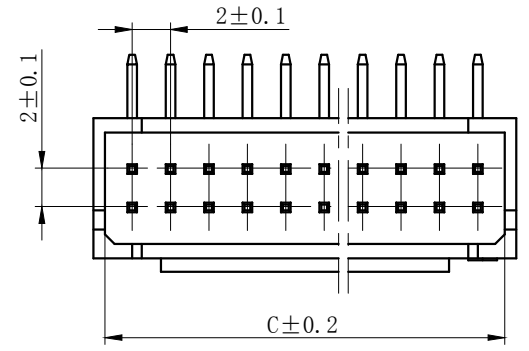
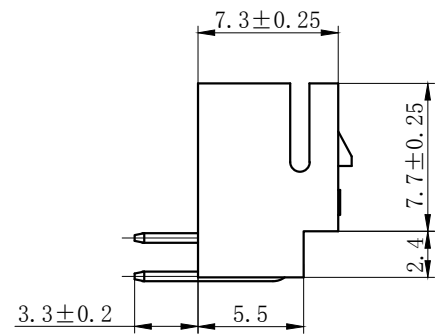
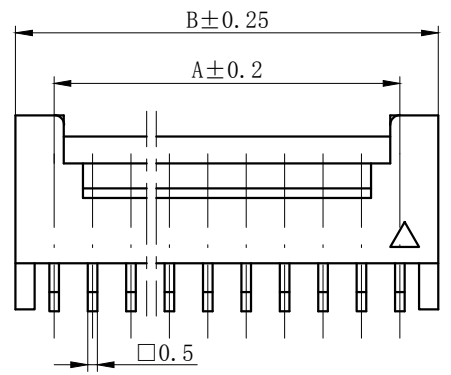

| Circuits | Product name | Dimension mm | | | Circuits | Product name | Dimension mm | | | Circuits | Product name | Dimension mm | | |
|----------|--------------|--------------|-------|-------|----------|--------------|--------------|-------|-------|----------|--------------|--------------|-------|-------|
| | | A | B | C | | | A | B | C | | | A | B | C |
| 2X2 | PHB-4AWD | 2.00 | 6.00 | 4.90 | 2X10 | PHB-20AWD | 18.00 | 22.00 | 20.90 | 2X18 | PHB-36AWD | 34.00 | 38.00 | 36.90 |
| 2X3 | PHB-6AWD | 4.00 | 8.00 | 6.90 | 2X11 | PHB-22AWD | 20.00 | 24.00 | 22.90 | 2X19 | PHB-38AWD | 36.00 | 40.00 | 38.90 |
| 2X4 | PHB-8AWD | 6.00 | 10.00 | 8.90 | 2X12 | PHB-24AWD | 22.00 | 26.00 | 24.90 | 2X20 | PHB-40AWD | 38.00 | 42.00 | 40.90 |
| 2X5 | PHB-10AWD | 8.00 | 12.00 | 10.90 | 2X13 | PHB-26AWD | 24.00 | 28.00 | 26.90 | ~ | ~ | ~ | ~ | ~ |
| 2X6 | PHB-12AWD | 10.00 | 14.00 | 12.90 | 2X14 | PHB-28AWD | 26.00 | 30.00 | 28.90 | 2X30 | PHB-60AWD | 58.00 | 62.00 | 60.90 |
| 2X7 | PHB-14AWD | 12.00 | 16.00 | 14.90 | 2X15 | PHB-30AWD | 28.00 | 32.00 | 30.90 | | | | | |
| 2X8 | PHB-16AWD | 14.00 | 18.00 | 16.90 | 2X16 | PHB-32AWD | 30.00 | 34.00 | 32.90 | | | | | |
| 2X9 | PHB-18AWD | 16.00 | 20.00 | 18.90 | 2X17 | PHB-34AWD | 32.00 | 36.00 | 34.90 | | | | | |

| | | | |
|--|--------------|---|--|
| GENERAL TOLERANCES (UNLESS SPECIFIED) | | 浙江德利接插件有限公司 ZHEJIANG DELI CONNECTORS CO.,LTD | |
| .X: ± 0.25 | X°: ± 3.0° | PRODUCT NAME: DL20006 (PHB)-AWD | TITLE: 2.00 mm Pitch Wire To Board Wafer |
| .XX: ± 0.15 | .X°: ± 2.0° | DR: Chen Quan Long | DATE: 20.11.30 |
| .XXX: ± 0.01 | .XX°: ± 1.0° | CHKD: Wu Hui | DATE: 20.11.30 |
| FINISH: | | APPD: Ren An De | DATE: 20.11.30 |
| DRAWING NO: | | | UNITS: mm |
| | | | PAGE: 1/1 |
| | | | REV.: A |

| | | | |
|------|----------------------|------|------|
| REV. | REVISION DESCRIPTION | DATE | APPD |
| | | | |



NOTES

Available in 04 through 60 Circuits.
 Mates with DL20006-Y Series Housing.
 Material : Nylon UL94V-0(2).
 0.50mm Square Pin.
 Pin Material : Brass / Tin-Plated.



| Circuits | Product name | Dimension mm | | | Circuits | Product name | Dimension mm | | | Circuits | Product name | Dimension mm | | |
|----------|--------------|--------------|-------|-------|----------|--------------|--------------|-------|-------|----------|--------------|--------------|-------|-------|
| | | A | B | C | | | A | B | C | | | A | B | C |
| 2X2 | PHB-4AWD-S | 2.00 | 6.00 | 4.90 | 2X10 | PHB-20AWD-S | 18.00 | 22.00 | 20.90 | 2X18 | PHB-36AWD-S | 34.00 | 38.00 | 36.90 |
| 2X3 | PHB-6AWD-S | 4.00 | 8.00 | 6.90 | 2X11 | PHB-22AWD-S | 20.00 | 24.00 | 22.90 | 2X19 | PHB-38AWD-S | 36.00 | 40.00 | 38.90 |
| 2X4 | PHB-8AWD-S | 6.00 | 10.00 | 8.90 | 2X12 | PHB-24AWD-S | 22.00 | 26.00 | 24.90 | 2X20 | PHB-40AWD-S | 38.00 | 42.00 | 40.90 |
| 2X5 | PHB-10AWD-S | 8.00 | 12.00 | 10.90 | 2X13 | PHB-26AWD-S | 24.00 | 28.00 | 26.90 | ~ | ~ | ~ | ~ | ~ |
| 2X6 | PHB-12AWD-S | 10.00 | 14.00 | 12.90 | 2X14 | PHB-28AWD-S | 26.00 | 30.00 | 28.90 | 2X30 | PHB-60AWD-S | 58.00 | 62.00 | 60.90 |
| 2X7 | PHB-14AWD-S | 12.00 | 16.00 | 14.90 | 2X15 | PHB-30AWD-S | 28.00 | 32.00 | 30.90 | | | | | |
| 2X8 | PHB-16AWD-S | 14.00 | 18.00 | 16.90 | 2X16 | PHB-32AWD-S | 30.00 | 34.00 | 32.90 | | | | | |
| 2X9 | PHB-18AWD-S | 16.00 | 20.00 | 18.90 | 2X17 | PHB-34AWD-S | 32.00 | 36.00 | 34.90 | | | | | |

| | | | |
|--|--------------|--|--|
| GENERAL TOLERANCES (UNLESS SPECIFIED) | | 浙江德利接插件有限公司 ZHEJIANG DELI CONNECTORS CO., LTD | |
| .X: ± 0.25 | .X°: ± 3.0° | PRODUCT NAME: DL20006 (PHB)-AWD-S | TITLE: 2.00 mm Pitch Wire To Board Wafer |
| .XX: ± 0.15 | .X°: ± 2.0° | DR: Ke Xian Qiang | DATE: 23.10.20 |
| .XXX: ± 0.01 | .XX°: ± 1.0° | CHKD: Liu Bing | DATE: 23.10.20 |
| FINISH: | | APPD: Ren An De | DATE: 23.10.20 |
| DRAWING NO: | | | SCALE: N/A |
| | | | PAGE: 1/1 |
| | | | UNITS: mm |
| | | | REV.: A |

| | | | |
|------|----------------------|------|------|
| REV. | REVISION DESCRIPTION | DATE | APPD |
| | | | |



NOTES

Available in 04 through 60 Circuits.
Mates with DL20006-Y Series Housing.

Material : Nylon UL94V-0(2).
0.50mm Square Pin.

Pin Material : Brass / Tin-Plated.

COLOR (颜色) : DL20006 (PHB)-AWD-S-XX

RE:red (红色); BR:brown (棕色); GY:gray (灰色);
BK:black (黑色); OR:orange (橙色); BL:blue (蓝色);
GE:green (绿色); OW:off-white (米黄色);
PU:purple (紫色); PI:pink (粉色); YE:yellow (黄色);
TR:transparent (透明色); OT:other (其它)

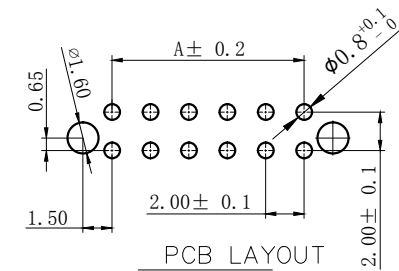

| Circuits | Product name | Dimension mm | | | Circuits | Product name | Dimension mm | | | Circuits | Product name | Dimension mm | | |
|----------|----------------|--------------|-------|-------|----------|----------------|--------------|-------|-------|----------|----------------|--------------|-------|-------|
| | | A | B | C | | | A | B | C | | | A | B | C |
| 2X2 | PHB-4AWD-S-XX | 2.00 | 6.00 | 4.90 | 2X10 | PHB-20AWD-S-XX | 18.00 | 22.00 | 20.90 | 2X18 | PHB-36AWD-S-XX | 34.00 | 38.00 | 36.90 |
| 2X3 | PHB-6AWD-S-XX | 4.00 | 8.00 | 6.90 | 2X11 | PHB-22AWD-S-XX | 20.00 | 24.00 | 22.90 | 2X19 | PHB-38AWD-S-XX | 36.00 | 40.00 | 38.90 |
| 2X4 | PHB-8AWD-S-XX | 6.00 | 10.00 | 8.90 | 2X12 | PHB-24AWD-S-XX | 22.00 | 26.00 | 24.90 | 2X20 | PHB-40AWD-S-XX | 38.00 | 42.00 | 40.90 |
| 2X5 | PHB-10AWD-S-XX | 8.00 | 12.00 | 10.90 | 2X13 | PHB-26AWD-S-XX | 24.00 | 28.00 | 26.90 | ~ | ~ | ~ | ~ | ~ |
| 2X6 | PHB-12AWD-S-XX | 10.00 | 14.00 | 12.90 | 2X14 | PHB-28AWD-S-XX | 26.00 | 30.00 | 28.90 | 2X30 | PHB-60AWD-S-XX | 58.00 | 62.00 | 60.90 |
| 2X7 | PHB-14AWD-S-XX | 12.00 | 16.00 | 14.90 | 2X15 | PHB-30AWD-S-XX | 28.00 | 32.00 | 30.90 | | | | | |
| 2X8 | PHB-16AWD-S-XX | 14.00 | 18.00 | 16.90 | 2X16 | PHB-32AWD-S-XX | 30.00 | 34.00 | 32.90 | | | | | |
| 2X9 | PHB-18AWD-S-XX | 16.00 | 20.00 | 18.90 | 2X17 | PHB-34AWD-S-XX | 32.00 | 36.00 | 34.90 | | | | | |

| | | | |
|--|--------------|--|--|
| GENERAL TOLERANCES (UNLESS SPECIFIED) | | 浙江德利接插件有限公司 ZHEJIANG DELI CONNECTORS CO., LTD | |
| .X: ± 0.25 | X°: ± 3.0° | PRODUCT NAME: DL20006 (PHB)-AWD-S-XX | TITLE: 2.00 mm Pitch Wire To Board Wafer |
| .XX: ± 0.15 | .X°: ± 2.0° | DR: Ke Xian Qiang | DATE: 23.10.20 |
| .XXX: ± 0.01 | .XX°: ± 1.0° | CHKD: Liu Bing | DATE: 23.10.20 |
| FINISH: | | APPD: Ren An De | DATE: 23.10.20 |
| DRAWING NO: | | SCALE: N/A | PAGE: 1/1 |
| | | UNITS: mm | REV.: A |

| | | | |
|------|----------------------|------|------|
| REV. | REVISION DESCRIPTION | DATE | APPD |
| | | | |



NOTES
 Available in 04 through 60 Circuits.
 Match with DL20006 series housing
 Material : Nylon UL94V-0(2).
 Accepts DL20006-T Crimp Terminal.

| Circuits | Product name | Dimension mm | | | Circuits | Product name | Dimension mm | | | Circuits | Product name | Dimension mm | | |
|----------|--------------|--------------|-------|-------|----------|--------------|--------------|-------|-------|----------|--------------|--------------|-------|-------|
| | | A | B | C | | | A | B | C | | | A | B | C |
| 2X2 | PHB-4Y | 7.00 | 4.70 | 2.00 | 2X10 | PHB-20Y | 23.00 | 20.70 | 18.00 | 2X18 | PHB-36Y | 39.00 | 36.70 | 34.00 |
| 2X3 | PHB-6Y | 9.00 | 6.70 | 4.00 | 2X11 | PHB-22Y | 25.00 | 22.70 | 20.00 | 2X19 | PHB-38Y | 41.00 | 38.70 | 36.00 |
| 2X4 | PHB-8Y | 11.00 | 8.70 | 6.00 | 2X12 | PHB-24Y | 27.00 | 24.70 | 22.00 | 2X20 | PHB-40Y | 43.00 | 40.70 | 38.00 |
| 2X5 | PHB-10Y | 13.00 | 10.70 | 8.00 | 2X13 | PHB-26Y | 29.00 | 26.70 | 24.00 | 2X21 | PHB-42Y | 45.00 | 42.70 | 40.00 |
| 2X6 | PHB-12Y | 15.00 | 12.70 | 10.00 | 2X14 | PHB-28Y | 31.00 | 28.70 | 26.00 | 2X22 | PHB-44Y | 47.00 | 44.70 | 42.00 |
| 2X7 | PHB-14Y | 17.00 | 14.70 | 12.00 | 2X15 | PHB-30Y | 33.00 | 30.70 | 28.00 | ~ | ~ | ~ | ~ | ~ |
| 2X8 | PHB-16Y | 19.00 | 16.70 | 14.00 | 2X16 | PHB-32Y | 35.00 | 32.70 | 30.00 | 2X30 | PHB-60Y | 63.00 | 60.70 | 58.00 |
| 2X9 | PHB-18Y | 21.00 | 18.70 | 16.00 | 2X17 | PHB-34Y | 37.00 | 34.70 | 32.00 | | | | | |

| | | | |
|--|--------------|--|-------------------------------------|
| GENERAL TOLERANCES (UNLESS SPECIFIED) | | 浙江德利接插件有限公司 ZHE JIANG DELI CONNECTORS CO.,LTD | |
| .X: ± 0.25 | X°: ± 3.0° | PRODUCT NAME: DL20006 (PHB)-Y | TITLE: 2.00 mm Pitch Housing |
| .XX: ± 0.15 | .X°: ± 2.0° | DR: Yuan Jun Rong | DATE:20.11.30 |
| .XXX: ± 0.01 | .XX°: ± 1.0° | CHKD: Wu Hui | DATE:20.11.30 |
| FINISH: _____ | | APPD: Ren An De | DATE:20.11.30 |
| DRAWING NO: | | | PART NO: SCALE: N/A UNITS: mm |
| | | | PAGE: 1/1 REV.: B |

1

2

3

4

5

6

7

8

| REV. | REVISION DESCRIPTION | DATE | APPD |
|------|----------------------|------|------|
| | | | |

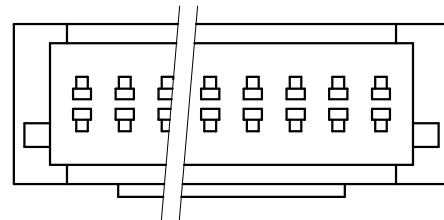
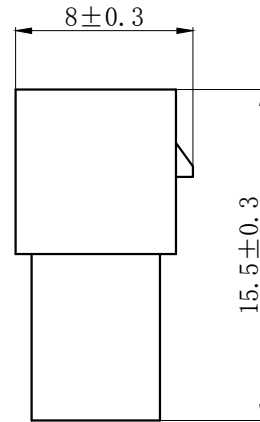
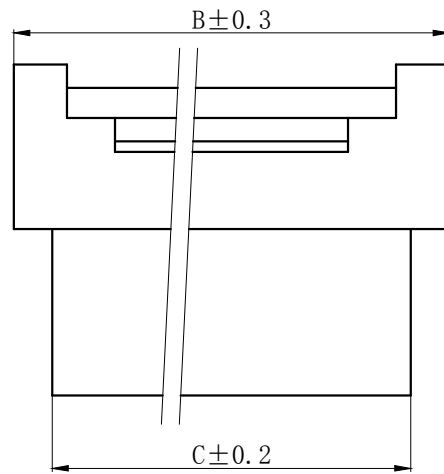

NOTES

Available in 04 through 60 Circuits.
 Mates with DL20006-Y Series Housing.
 Material : Nylon UL94V-0(2).
 Accepts DL20006-RT Crimp Terminal.

| Circuits | Product name | Dimension mm | | | Circuits | Product name | Dimension mm | | | Circuits | Product name | Dimension mm | | |
|----------|--------------|--------------|-------|-------|----------|--------------|--------------|-------|-------|----------|--------------|--------------|-------|-------|
| | | A | B | C | | | A | B | C | | | A | B | C |
| 2X2 | PHB-4R | 2.00 | 8.40 | 4.80 | 2X10 | PHB-20R | 18.00 | 24.40 | 20.80 | 2X18 | PHB-36R | 34.00 | 40.40 | 36.80 |
| 2X3 | PHB-6R | 4.00 | 10.40 | 6.80 | 2X11 | PHB-22R | 20.00 | 26.40 | 22.80 | 2X19 | PHB-38R | 36.00 | 42.40 | 38.80 |
| 2X4 | PHB-8R | 6.00 | 12.40 | 8.80 | 2X12 | PHB-24R | 22.00 | 28.40 | 24.80 | 2X20 | PHB-40R | 38.00 | 44.40 | 40.80 |
| 2X5 | PHB-10R | 8.00 | 14.40 | 10.80 | 2X13 | PHB-26R | 24.00 | 30.40 | 26.80 | ~ | ~ | ~ | ~ | ~ |
| 2X6 | PHB-12R | 10.00 | 16.40 | 12.80 | 2X14 | PHB-28R | 26.00 | 32.40 | 28.80 | 2X30 | PHB-60R | 58.00 | 64.40 | 60.80 |
| 2X7 | PHB-14R | 12.00 | 18.40 | 14.80 | 2X15 | PHB-30R | 28.00 | 34.40 | 30.80 | | | | | |
| 2X8 | PHB-16R | 14.00 | 20.40 | 16.80 | 2X16 | PHB-32R | 30.00 | 36.40 | 32.80 | | | | | |
| 2X9 | PHB-18R | 16.00 | 22.40 | 18.80 | 2X17 | PHB-34R | 32.00 | 38.40 | 34.80 | | | | | |

GENERAL TOLERANCES
(UNLESS SPECIFIED)

| | |
|--------------|----------------|
| .X: ± 0.25 | .X° : ± 3.0° |
| .XX: ± 0.15 | .XX° : ± 2.0° |
| .XXX: ± 0.01 | .XXX° : ± 1.0° |
| FINISH: | |
| DRAWING NO: | |

浙江德利接插件有限公司
 ZHE JIANG DELI CONNECTORS CO.,LTD

| | |
|---------------------------------|---|
| PRODUCT NAME: DL20006(PHB)-R | TITLE: 2.00 mm Pitch Wire To Wire Housing |
| DR:Chen Quan Long DATE:20.11.30 | PART NO: |
| CHKD: Wu Hui DATE:20.11.30 | SCALE: N/A PAGE: 1/1 |
| APPD:Ren An De DATE:20.11.30 | UNITS: mm REV.: A |

1

2

3

4

5

6

7

8

A

B

C

D

E

F

A

B

C

D

E

F

| REV. | REVISION DESCRIPTION | DATE | APPD |
|------|----------------------|----------|------|
| B | PHB-T开口处及倒勾尺寸调整 | 13/12/26 | 刘兵 |
| C | 调整小压线脚尺寸 | 17/04/13 | 吴慧 |
| D | 调整倒勾形状 | 18/09/25 | 吴慧 |



NOTES

Used in DL20006-Y or DL20026-Y Series Housing.
 Accepts AWG #28~22 Wire Range.
 0.08~ 0.33 mm² .
 Insulation O. D. =0.9~1.5 mm.
 Material : Phosphor Bronze .
 Finish: Tin plated.



| TYPE | Dimension mm | | | | 适用线规 |
|----------|--------------|-----|-----|-----|-------|
| | A1 | B1 | A2 | B2 | AWG# |
| PHB-T-02 | 2.1 | 2.3 | 1.6 | 1.7 | 24-22 |
| PHB-T-01 | 2.0 | 1.8 | 1.5 | 1.5 | 28-24 |

| | | | | | |
|---------------------------------------|--------------|------------------------------------|--|--|--|
| GENERAL TOLERANCES (UNLESS SPECIFIED) | | ZHE JIANG DELI CONNECTORS CO., LTD | | | |
| .X: ± 0.25 | X°: ± 3.0° | PRODUCT NAME: DL20006 (PHB)-T | | TITLE: 2.00 mm Pitch Crimp Terminal | |
| .XX: ± 0.15 | .X°: ± 2.0° | DR: Chen Quan Long | | DATE: 20/04/13 | |
| .XXX: ± 0.01 | .XX°: ± 1.0° | CHKD: Wu hui | | DATE: 20/04/13 | |
| DRAWING NO: | | APPD: Ren An De | | DATE: 20/04/13 | |
| | | SCALE: N/A | | PAGE: 1/1 | |
| | | UNITS: mm | | REV.: D | |

| REV. | REVISION DESCRIPTION | DATE | APPD |
|------|----------------------|------|------|
| | | | |



NOTES

Used in DL20001-R Series Housing.
 Accepts AWG #28~22 Wire Range.
 $0.05 \sim 0.22 \text{ mm}^2$.
 Insulation O. D. = $0.9 \sim 1.5$ mm.
 Material : Phosphor Bronze .
 Finish: Tin plated.
 Thickness: 0.2 mm.

| | | | |
|---------------------------------------|-----------------------|---|--|
| GENERAL TOLERANCES (UNLESS SPECIFIED) | | ZHE JIANG DELI CONNECTORS CO., LTD | |
| .X: ± 0.25 | X°: $\pm 3.0^\circ$ | PRODUCT NAME: DL20001 (PH)-RT | TITLE: 2.00 mm Pitch Wire To Wire Crimp Terminal |
| .XX: ± 0.15 | .X°: $\pm 2.0^\circ$ | DR: Chen Quan Long | DATE: 20/01/26 |
| .XXX: ± 0.01 | .XX°: $\pm 1.0^\circ$ | CHKD: Wu Hui | DATE: 20/01/26 |
| DRAWING NO: | | APPD: Ren An De | DATE: 20/01/26 |
| FINISH: | | SCALE: N/A | PAGE: 1/1 |
| | | UNITS: mm | REV.: A |

X-ON Electronics

Largest Supplier of Electrical and Electronic Components

Click to view similar products for [Headers & Wire Housings](#) category:

Click to view products by [DLL](#) manufacturer:

Other Similar products are found below :

[0015917161](#) [0022155065](#) [57102-F02-18ULF](#) [58102-G61-06LF](#) [582553-1](#) [01.001.5753.1](#) [0050291907](#) [02.125.8002.8](#) [609-3404](#) [61062-3](#)
[CSU011177004](#) [622-0430](#) [622-3653LF](#) [63453-116](#) [636-1030](#) [636-1427](#) [636-3427](#) [636-4007](#) [641938-9](#) [65495-038](#) [65692-001LF](#) [65781-018](#)
[65781-047](#) [65817-010LF](#) [65817-015LF](#) [67095-007LF](#) [67601157](#) [68631-112](#) [68645-018](#) [699319-000](#) [70.362.1628.0](#) [70-4210](#) [70-4226B](#) [70-](#)
[4853B](#) [71.350.2428.0](#) [733-134](#) [733-162](#) [MHR-64-VUAL](#) [80.063.4001.1](#) [800-90-001-10-001000](#) [801-43-002-10-013000](#) [801-43-006-10-](#)
[002000](#) [803-43-024-10-001000](#) [803-93-012-10-001000](#) [8-1437020-4](#) [819-22-004-30-001101](#) [820-22-006-30-001101](#) [820-22-008-30-001101](#)
[821-22-002-10-001101](#) [821-22-003-10-002101](#)