



技术特性/Specifications:

额定电压 Rated voltage: 250V AC, DC
额定电流 Rated current: 2A AC, DC
接触电阻 Contact resistance: 20mΩ max
绝缘电阻 Insulation resistance: 1000MΩ min
耐压 Withstand voltage: 800V AC/minute
环境温度 Ambient temperature: -40°C~+105°C
适用线规 Wire range: AWG#28~#22

REV.	REVISION DESCRIPTION	DATE	APPD

NOTES

Available in 04 through 60 Circuits.
 Mates with DL20006-XXY Series Housing.
 Material : LCP UL94V-0.
 Pin Material : Brass.Tin-plated .



PCB LAYOUT



Circuits	Product name	Dimension mm			Circuits	Product name	Dimension mm		
		A	B	C			A	B	C
2X2	PHB-4AB	2.00	9.00	5.00	2X11	PHB-22AB	20.00	27.00	23.00
2X3	PHB-6AB	4.00	11.00	7.00	2X12	PHB-24AB	22.00	29.00	25.00
2X4	PHB-8AB	6.00	13.00	9.00	2X13	PHB-26AB	24.00	31.00	27.00
2X5	PHB-10AB	8.00	15.00	11.00	2X14	PHB-28AB	26.00	33.00	29.00
2X6	PHB-12AB	10.00	17.00	13.00	2X15	PHB-30AB	28.00	35.00	31.00
2X7	PHB-14AB	12.00	19.00	15.00	2X16	PHB-32AB	30.00	37.00	33.00
2X8	PHB-16AB	14.00	21.00	17.00	2X17	PHB-34AB	32.00	39.00	35.00
2X9	PHB-18AB	16.00	23.00	19.00	-	-	-	-	-
2X10	PHB-20AB	18.00	25.00	21.00	2X30	PHB-60AB	58.00	65.00	61.00

3	③	基座	LCP	1	UL94V-0
2	②	焊片	黄铜	2	镀锡
1	①	接触件	黄铜	N*	镀锡
序号	图号	名称	材料	数量	附件

GENERAL TOLERANCES (UNLESS SPECIFIED)		ZHE JIANG DELI CONNECTORS CO., LTD			
.X: ± 0.25	X°: ± 3.0°	PRODUCT NAME: DL20006 (PHB) -AB		TITLE: 2.0 mm Pitch Wire To Board SMT Wafer	
.XX: ± 0.15	.X°: ± 2.0°	DR: Chen Quan Long DATE: 20/09/03		PART NO:	
.XXX: ± 0.01	.XX°: ± 1.0°	CHKD: Wu Hui DATE: 20/09/03		SCALE: N/A PAGE: 1/1	
FINISH:		APPD: Ren An De DATE: 20/09/03		UNITS: mm REV.: A	
DRAWING NO:					

REV.	REVISION DESCRIPTION	DATE	APPD



NOTES

Available in 04 through 60 Circuits.
 Mates with DL20006-Y Series Housing.
 Material : LCP UL94V-0.
 0.50mm Square Pin.
 Pin Material : Brass / Tin-Plated.

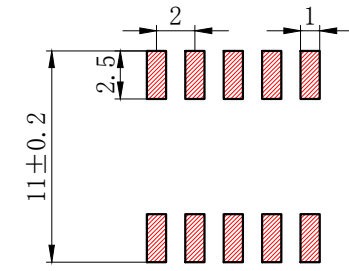

PCB LAYOUT

Circuits	Product name	Dimension mm			Circuits	Product name	Dimension mm			Circuits	Product name	Dimension mm		
		A	B	C			A	B	C			A	B	C
2X2	PHB-4ABZ	2.00	6.00	4.90	2X10	PHB-20ABZ	18.00	22.00	20.90	2X18	PHB-36ABZ	34.00	38.00	36.90
2X3	PHB-6ABZ	4.00	8.00	6.90	2X11	PHB-22ABZ	20.00	24.00	22.90	2X19	PHB-38ABZ	36.00	40.00	38.90
2X4	PHB-8ABZ	6.00	10.00	8.90	2X12	PHB-24ABZ	22.00	26.00	24.90	2X20	PHB-40ABZ	38.00	42.00	40.90
2X5	PHB-10ABZ	8.00	12.00	10.90	2X13	PHB-26ABZ	24.00	28.00	26.90	~	~	~	~	~
2X6	PHB-12ABZ	10.00	14.00	12.90	2X14	PHB-28ABZ	26.00	30.00	28.90	2X30	PHB-60ABZ	58.00	62.00	60.90
2X7	PHB-14ABZ	12.00	16.00	14.90	2X15	PHB-30ABZ	28.00	32.00	30.90					
2X8	PHB-16ABZ	14.00	18.00	16.90	2X16	PHB-32ABZ	30.00	34.00	32.90					
2X9	PHB-18ABZ	16.00	20.00	18.90	2X17	PHB-34ABZ	32.00	36.00	34.90					

GENERAL TOLERANCES (UNLESS SPECIFIED)		ZHE JIANG DELI CONNECTORS CO., LTD	
.X: ± 0.25	X°: ± 3.0°	PRODUCT NAME:	TITLE: 2.00 mm Pitch Wire To Board Wafer
.XX: ± 0.15	.X°: ± 2.0°	DL20006 (PHB)-ABZ	PART NO:
.XXX: ± 0.01	.XX°: ± 1.0°	DR: Chen Quan Long	DATE: 21.7.16
FINISH:		CHKD: Wu Hui	DATE: 21.7.16
DRAWING NO:		APPD: Ren An De	DATE: 21.7.16
			SCALE: N/A
			PAGE: 1/1
			UNITS: mm
			REV.: A

REV.	REVISION DESCRIPTION	DATE	APPD



NOTES

Available in 04 through 60 Circuits.
 Mates with DL20006-XXY Series Housing.
 Material : LCP UL94V-0.
 Pin Material : Brass.Tin-plated .



Type	Product name	Dimension mm			Type	Product name	Dimension mm		
		A	B	C			A	B	C
2X2	PHB-4AWB	2.00	9.00	5.00	2X11	PHB-22AWB	20.00	27.00	23.00
2X3	PHB-6AWB	4.00	11.00	7.00	2X12	PHB-24AWB	22.00	29.00	25.00
2X4	PHB-8AWB	6.00	13.00	9.00	2X13	PHB-26AWB	24.00	31.00	27.00
2X5	PHB-10AWB	8.00	15.00	11.00	2X14	PHB-28AWB	26.00	33.00	29.00
2X6	PHB-12AWB	10.00	17.00	13.00	2X15	PHB-32AWB	28.00	35.00	31.00
2X7	PHB-14AWB	12.00	19.00	15.00	2X16	PHB-32AWB	30.00	37.00	33.00
2X8	PHB-16AWB	14.00	21.00	17.00	2X17	PHB-34AWB	32.00	39.00	35.00
2X9	PHB-18AWB	16.00	23.00	19.00	-	-	-	-	-
2X10	PHB-20AWB	18.00	25.00	21.00	2X30	PHB-60AWB	58.00	65.00	61.00

3	③	基座	LCP	1	UL94V-0
2	②	焊片	黄铜	2	镀锡
1	①	接触件	黄铜	N*	镀锡
序号	图号	名称	材料	数量	附件

GENERAL TOLERANCES (UNLESS SPECIFIED)		ZHE JIANG DELI CONNECTORS CO., LTD			
.X: ± 0.25	X°: ± 3.0°	PRODUCT NAME: DL20006 (PHB)-AWB		TITLE: 2.0 mm Pitch Wire To Board SMT Wafer	
.XX: ± 0.15	.X°: ± 2.0°	DR: Chen Quan Long		DATE: 20/09/03	
.XXX: ± 0.01	.XX°: ± 1.0°	FINISH: _____		PART NO:	
DRAWING NO: _____		CHKD: Wu Hui	DATE: 20/09/03	SCALE: N/A	PAGE: 1/1
		APPD: Ren An De	DATE: 20/09/03	UNITS: mm	REV.: A

REV.	REVISION DESCRIPTION	DATE	APPD
A	3.4调整3.3±0.2		LIU



NOTES
 Available in 04 through 60 Circuits.
 Mates with DL20006-Y Series Housing.
 Material : Nylon UL94V-0(2).
 0.50mm Square Pin.
 Pin Material : Brass / Tin-Plated.

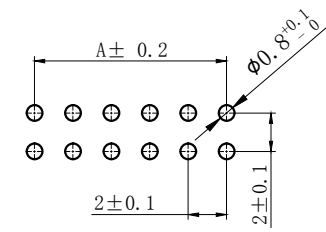
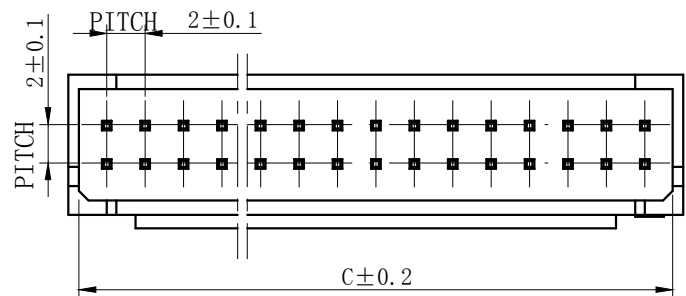
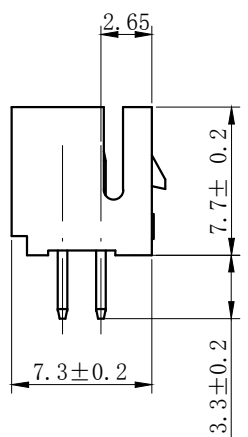
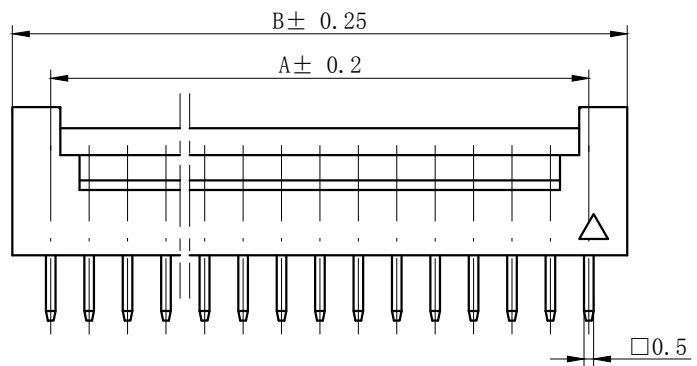

PCB LAYOUT

Circuits	Product name	Dimension mm			Circuits	Product name	Dimension mm			Circuits	Product name	Dimension mm		
		A	B	C			A	B	C			A	B	C
2X2	PHB-4A	2.00	6.00	4.90	2X10	PHB-20A	18.00	22.00	20.90	2X18	PHB-36A	34.00	38.00	36.90
2X3	PHB-6A	4.00	8.00	6.90	2X11	PHB-22A	20.00	24.00	22.90	2X19	PHB-38A	36.00	40.00	38.90
2X4	PHB-8A	6.00	10.00	8.90	2X12	PHB-24A	22.00	26.00	24.90	2X20	PHB-40A	38.00	42.00	40.90
2X5	PHB-10A	8.00	12.00	10.90	2X13	PHB-26A	24.00	28.00	26.90	~	~	~	~	~
2X6	PHB-12A	10.00	14.00	12.90	2X14	PHB-28A	26.00	30.00	28.90	2X30	PHB-60A	58.00	62.00	60.90
2X7	PHB-14A	12.00	16.00	14.90	2X15	PHB-30A	28.00	32.00	30.90					
2X8	PHB-16A	14.00	18.00	16.90	2X16	PHB-32A	30.00	34.00	32.90					
2X9	PHB-18A	16.00	20.00	18.90	2X17	PHB-34A	32.00	36.00	34.90					

GENERAL TOLERANCES (UNLESS SPECIFIED)		浙江德利接插件有限公司 ZHEJIANG DELI CONNECTORS CO.,LTD	
.X: ± 0.25	X°: ± 3.0°	PRODUCT NAME: DL20006 (PHB)-A	TITLE: 2.00 mm Pitch Wire To Board Wafer
.XX: ± 0.15	.X°: ± 2.0°	DR: Yuan Jun Rong	DATE:20.11.30
.XXX: ± 0.01	.XX°: ± 1.0°	CHKD: Wu Hui	DATE:20.11.30
FINISH: _____		APPD:Ren An De	DATE:20.11.30
DRAWING NO:			PART NO: SCALE: N/A UNITS: mm
			PAGE: 1/1 REV.: A

REV.	REVISION DESCRIPTION	DATE	APPD

NOTES

Available in 04 through 60 Circuits.
 Mates with DL20006-Y Series Housing.
 Material : Nylon UL94V-0(2).
 0.50mm Square Pin.
 Pin Material : Brass / Tin-Plated.



Circuits	Product name	Dimension mm			Circuits	Product name	Dimension mm			Circuits	Product name	Dimension mm		
		A	B	C			A	B	C			A	B	C
2X2	PHB-4AW	2.00	6.00	4.90	2X10	PHB-20AW	18.00	22.00	20.90	2X18	PHB-36AW	34.00	38.00	36.90
2X3	PHB-6AW	4.00	8.00	6.90	2X11	PHB-22AW	20.00	24.00	22.90	2X19	PHB-38AW	36.00	40.00	38.90
2X4	PHB-8AW	6.00	10.00	8.90	2X12	PHB-24AW	22.00	26.00	24.90	2X20	PHB-40AW	38.00	42.00	40.90
2X5	PHB-10AW	8.00	12.00	10.90	2X13	PHB-26AW	24.00	28.00	26.90	~	~	~	~	~
2X6	PHB-12AW	10.00	14.00	12.90	2X14	PHB-28AW	26.00	30.00	28.90	2X30	PHB-60AW	58.00	62.00	60.90
2X7	PHB-14AW	12.00	16.00	14.90	2X15	PHB-30AW	28.00	32.00	30.90					
2X8	PHB-16AW	14.00	18.00	16.90	2X16	PHB-32AW	30.00	34.00	32.90					
2X9	PHB-18AW	16.00	20.00	18.90	2X17	PHB-34AW	32.00	36.00	34.90					

GENERAL TOLERANCES (UNLESS SPECIFIED)		浙江德利接插件有限公司 ZHE JIANG DELI CONNECTORS CO., LTD	
.X: ± 0.25	X°: ± 3.0°	PRODUCT NAME: DL20006 (PHB)-AW	TITLE: 2.00 mm Pitch Wire To Board Wafer
.XX: ± 0.15	.X°: ± 2.0°	DR: Chen Quan Long	DATE: 20.11.30
.XXX: ± 0.01	.XX°: ± 1.0°	CHKD: Wu Hui	DATE: 20.11.30
DRAWING NO:		APPD: Ren An De	DATE: 20.11.30
		SCALE: N/A	PAGE: 1/1
		UNITS: mm	REV.: A

REV.	REVISION DESCRIPTION	DATE	APPD



NOTES

Available in 04 through 60 Circuits.
 Mates with DL20006-Y Series Housing.
 Material : Nylon UL94V-0(2).
 0.50mm Square Pin.
 Pin Material : Brass / Tin-Plated.



Circuits	Product name	Dimension mm			Circuits	Product name	Dimension mm			Circuits	Product name	Dimension mm		
		A	B	C			A	B	C			A	B	C
2X2	PHB-4AWD	2.00	6.00	4.90	2X10	PHB-20AWD	18.00	22.00	20.90	2X18	PHB-36AWD	34.00	38.00	36.90
2X3	PHB-6AWD	4.00	8.00	6.90	2X11	PHB-22AWD	20.00	24.00	22.90	2X19	PHB-38AWD	36.00	40.00	38.90
2X4	PHB-8AWD	6.00	10.00	8.90	2X12	PHB-24AWD	22.00	26.00	24.90	2X20	PHB-40AWD	38.00	42.00	40.90
2X5	PHB-10AWD	8.00	12.00	10.90	2X13	PHB-26AWD	24.00	28.00	26.90	~	~	~	~	~
2X6	PHB-12AWD	10.00	14.00	12.90	2X14	PHB-28AWD	26.00	30.00	28.90	2X30	PHB-60AWD	58.00	62.00	60.90
2X7	PHB-14AWD	12.00	16.00	14.90	2X15	PHB-30AWD	28.00	32.00	30.90					
2X8	PHB-16AWD	14.00	18.00	16.90	2X16	PHB-32AWD	30.00	34.00	32.90					
2X9	PHB-18AWD	16.00	20.00	18.90	2X17	PHB-34AWD	32.00	36.00	34.90					

GENERAL TOLERANCES (UNLESS SPECIFIED)		浙江德利接插件有限公司 ZHEJIANG DELI CONNECTORS CO., LTD	
.X: ± 0.25	X°: ± 3.0°	PRODUCT NAME: DL20006 (PHB)-AWD	TITLE: 2.00 mm Pitch Wire To Board Wafer
.XX: ± 0.15	.X°: ± 2.0°	DR: Chen Quan Long	DATE: 20.11.30
.XXX: ± 0.01	.XX°: ± 1.0°	DATE: 20.11.30	PART NO:
FINISH:		CHKD: Wu Hui	SCALE: N/A
DRAWING NO:		APPD: Ren An De	PAGE: 1/1
		DATE: 20.11.30	UNITS: mm
			REV.: A

REV.	REVISION DESCRIPTION	DATE	APPD

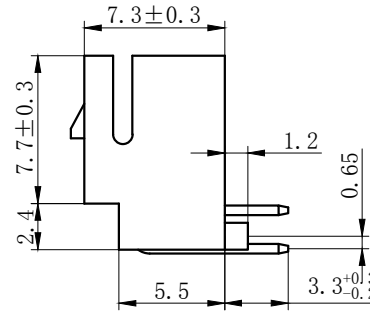

NOTES

Available in 04 through 60 Circuits.
 Mates with DL20006-Y Series Housing.
 Material : Nylon UL94V-0(2).
 0.50mm Square Pin.
 Pin Material : Brass / Tin-Plated.



Circuits	Product name	Dimension mm			Circuits	Product name	Dimension mm			Circuits	Product name	Dimension mm		
		A	B	C			A	B	C			A	B	C
2X2	PHB-4AWD-S	2.00	6.00	4.90	2X10	PHB-20AWD-S	18.00	22.00	20.90	2X18	PHB-36AWD-S	34.00	38.00	36.90
2X3	PHB-6AWD-S	4.00	8.00	6.90	2X11	PHB-22AWD-S	20.00	24.00	22.90	2X19	PHB-38AWD-S	36.00	40.00	38.90
2X4	PHB-8AWD-S	6.00	10.00	8.90	2X12	PHB-24AWD-S	22.00	26.00	24.90	2X20	PHB-40AWD-S	38.00	42.00	40.90
2X5	PHB-10AWD-S	8.00	12.00	10.90	2X13	PHB-26AWD-S	24.00	28.00	26.90	~	~	~	~	~
2X6	PHB-12AWD-S	10.00	14.00	12.90	2X14	PHB-28AWD-S	26.00	30.00	28.90	2X30	PHB-60AWD-S	58.00	62.00	60.90
2X7	PHB-14AWD-S	12.00	16.00	14.90	2X15	PHB-30AWD-S	28.00	32.00	30.90					
2X8	PHB-16AWD-S	14.00	18.00	16.90	2X16	PHB-32AWD-S	30.00	34.00	32.90					
2X9	PHB-18AWD-S	16.00	20.00	18.90	2X17	PHB-34AWD-S	32.00	36.00	34.90					

GENERAL TOLERANCES (UNLESS SPECIFIED)		浙江德利接插件有限公司 ZHEJIANG DELI CONNECTORS CO., LTD	
.X: ± 0.25	.X°: ± 3.0°	PRODUCT NAME: DL20006 (PHB)-AWD-S	TITLE: 2.00 mm Pitch Wire To Board Wafer
.XX: ± 0.15	.X°: ± 2.0°	DR: Ke Xian Qiang	DATE: 23.10.20
.XXX: ± 0.01	.XX°: ± 1.0°	CHKD: Liu Bing	DATE: 23.10.20
FINISH:		APPD: Ren An De	DATE: 23.10.20
DRAWING NO:		PART NO:	
		SCALE: N/A	PAGE: 1/1
		UNITS: mm	REV.: A

REV.	REVISION DESCRIPTION	DATE	APPD

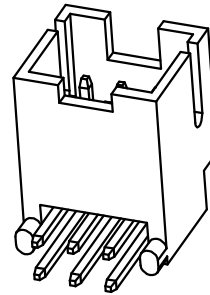
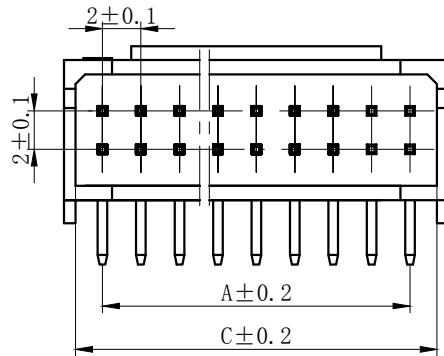
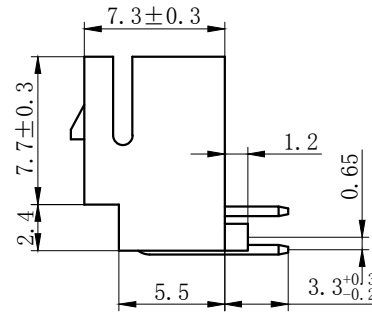
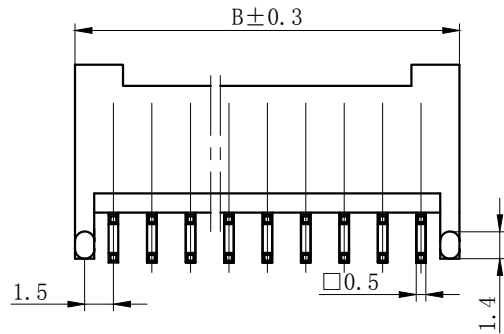

NOTES

Available in 04 through 60 Circuits.
 Mates with DL20006-Y Series Housing.
 Material : Nylon UL94V-0(2).
 0.50mm Square Pin.
 Pin Material : Brass / Tin-Plated.

COLOR (颜色): DL20006 (PHB)-AWD-S-XX

RE:red (红色); BR:brown (棕色); GY:gray (灰色);
 BK:black (黑色); OR:orange (橙色); BL:blue (蓝色);
 GE:green (绿色); OW:off-white (米黄色);
 PU:purple (紫色); PI:pink (粉色); YE:yellow (黄色);
 TR:transparent (透明色); OT:other (其它)

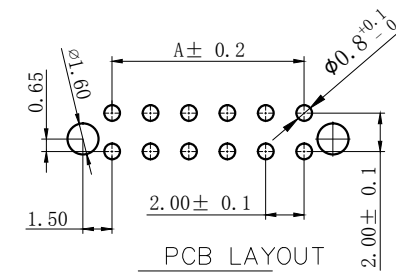

Circuits	Product name	Dimension mm			Circuits	Product name	Dimension mm			Circuits	Product name	Dimension mm		
		A	B	C			A	B	C			A	B	C
2X2	PHB-4AWD-S-XX	2.00	6.00	4.90	2X10	PHB-20AWD-S-XX	18.00	22.00	20.90	2X18	PHB-36AWD-S-XX	34.00	38.00	36.90
2X3	PHB-6AWD-S-XX	4.00	8.00	6.90	2X11	PHB-22AWD-S-XX	20.00	24.00	22.90	2X19	PHB-38AWD-S-XX	36.00	40.00	38.90
2X4	PHB-8AWD-S-XX	6.00	10.00	8.90	2X12	PHB-24AWD-S-XX	22.00	26.00	24.90	2X20	PHB-40AWD-S-XX	38.00	42.00	40.90
2X5	PHB-10AWD-S-XX	8.00	12.00	10.90	2X13	PHB-26AWD-S-XX	24.00	28.00	26.90	~	~	~	~	~
2X6	PHB-12AWD-S-XX	10.00	14.00	12.90	2X14	PHB-28AWD-S-XX	26.00	30.00	28.90	2X30	PHB-60AWD-S-XX	58.00	62.00	60.90
2X7	PHB-14AWD-S-XX	12.00	16.00	14.90	2X15	PHB-30AWD-S-XX	28.00	32.00	30.90					
2X8	PHB-16AWD-S-XX	14.00	18.00	16.90	2X16	PHB-32AWD-S-XX	30.00	34.00	32.90					
2X9	PHB-18AWD-S-XX	16.00	20.00	18.90	2X17	PHB-34AWD-S-XX	32.00	36.00	34.90					

GENERAL TOLERANCES (UNLESS SPECIFIED)		浙江德利接插件有限公司 ZHEJIANG DELI CONNECTORS CO., LTD	
.X: ± 0.25	X°: ± 3.0°	PRODUCT NAME: DL20006 (PHB)-AWD-S-XX	TITLE: 2.00 mm Pitch Wire To Board Wafer
.XX: ± 0.15	.X°: ± 2.0°	DR: Ke Xian Qiang	DATE: 23.10.20
.XXX: ± 0.01	.XX°: ± 1.0°	CHKD: Liu Bing	DATE: 23.10.20
FINISH:		APPD: Ren An De	DATE: 23.10.20
DRAWING NO:			SCALE: N/A
			PAGE: 1/1
			UNITS: mm
			REV.: A

REV.	REVISION DESCRIPTION	DATE	APPD



NOTES
 Available in 04 through 60 Circuits.
 Match with DL20006 series housing
 Material : Nylon UL94V-0(2).
 Accepts DL20006-T Crimp Terminal.

Circuits	Product name	Dimension mm			Circuits	Product name	Dimension mm			Circuits	Product name	Dimension mm		
		A	B	C			A	B	C			A	B	C
2X2	PHB-4Y	7.00	4.70	2.00	2X10	PHB-20Y	23.00	20.70	18.00	2X18	PHB-36Y	39.00	36.70	34.00
2X3	PHB-6Y	9.00	6.70	4.00	2X11	PHB-22Y	25.00	22.70	20.00	2X19	PHB-38Y	41.00	38.70	36.00
2X4	PHB-8Y	11.00	8.70	6.00	2X12	PHB-24Y	27.00	24.70	22.00	2X20	PHB-40Y	43.00	40.70	38.00
2X5	PHB-10Y	13.00	10.70	8.00	2X13	PHB-26Y	29.00	26.70	24.00	2X21	PHB-42Y	45.00	42.70	40.00
2X6	PHB-12Y	15.00	12.70	10.00	2X14	PHB-28Y	31.00	28.70	26.00	2X22	PHB-44Y	47.00	44.70	42.00
2X7	PHB-14Y	17.00	14.70	12.00	2X15	PHB-30Y	33.00	30.70	28.00	~	~	~	~	~
2X8	PHB-16Y	19.00	16.70	14.00	2X16	PHB-32Y	35.00	32.70	30.00	2X30	PHB-60Y	63.00	60.70	58.00
2X9	PHB-18Y	21.00	18.70	16.00	2X17	PHB-34Y	37.00	34.70	32.00					

GENERAL TOLERANCES (UNLESS SPECIFIED)		浙江德利接插件有限公司 ZHE JIANG DELI CONNECTORS CO.,LTD	
.X: ± 0.25	X°: ± 3.0°	PRODUCT NAME: DL20006 (PHB)-Y	TITLE: 2.00 mm Pitch Housing
.XX: ± 0.15	.X°: ± 2.0°	DR: Yuan Jun Rong	DATE:20.11.30
.XXX: ± 0.01	.XX°: ± 1.0°	CHKD: Wu Hui	DATE:20.11.30
FINISH: _____		APPD:Ren An De	DATE:20.11.30
DRAWING NO:			PART NO: SCALE: N/A
			PAGE: 1/1
			UNITS: mm
			REV.: B

1

2

3

4

5

6

7

8

REV.	REVISION DESCRIPTION	DATE	APPD

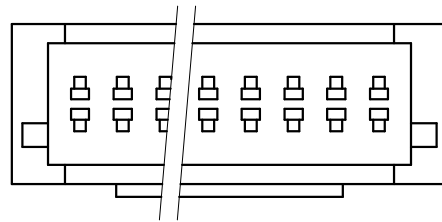
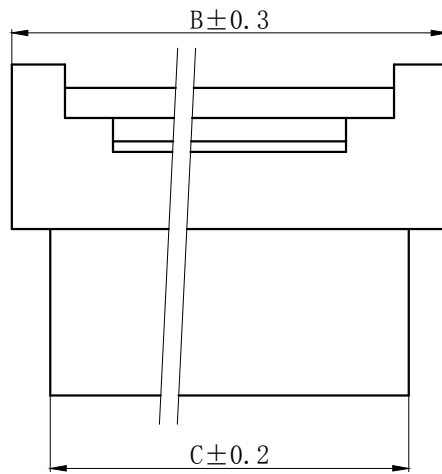

NOTES

Available in 04 through 60 Circuits.
 Mates with DL20006-Y Series Housing.
 Material : Nylon UL94V-0(2).
 Accepts DL20006-RT Crimp Terminal.

Circuits	Product name	Dimension mm			Circuits	Product name	Dimension mm			Circuits	Product name	Dimension mm		
		A	B	C			A	B	C			A	B	C
2X2	PHB-4R	2.00	8.40	4.80	2X10	PHB-20R	18.00	24.40	20.80	2X18	PHB-36R	34.00	40.40	36.80
2X3	PHB-6R	4.00	10.40	6.80	2X11	PHB-22R	20.00	26.40	22.80	2X19	PHB-38R	36.00	42.40	38.80
2X4	PHB-8R	6.00	12.40	8.80	2X12	PHB-24R	22.00	28.40	24.80	2X20	PHB-40R	38.00	44.40	40.80
2X5	PHB-10R	8.00	14.40	10.80	2X13	PHB-26R	24.00	30.40	26.80	~	~	~	~	~
2X6	PHB-12R	10.00	16.40	12.80	2X14	PHB-28R	26.00	32.40	28.80	2X30	PHB-60R	58.00	64.40	60.80
2X7	PHB-14R	12.00	18.40	14.80	2X15	PHB-30R	28.00	34.40	30.80					
2X8	PHB-16R	14.00	20.40	16.80	2X16	PHB-32R	30.00	36.40	32.80					
2X9	PHB-18R	16.00	22.40	18.80	2X17	PHB-34R	32.00	38.40	34.80					

GENERAL TOLERANCES
(UNLESS SPECIFIED)

.X: ± 0.25	.X°: ± 3.0°
.XX: ± 0.15	.XX°: ± 2.0°
.XXX: ± 0.01	.XXX°: ± 1.0°

FINISH: _____

DRAWING NO:

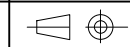

浙江德利接插件有限公司
ZHE JIANG DELI CONNECTORS CO., LTD

PRODUCT NAME: DL20006(PHB)-R TITLE: 2.00 mm Pitch Wire To Wire Housing

DR: Chen Quan Long DATE: 20.11.30 PART NO:

CHKD: Wu Hui DATE: 20.11.30 SCALE: N/A PAGE: 1/1

APPD: Ren An De DATE: 20.11.30 UNITS: mm REV.: A

1

2

3

4

5

6

7

8

A

B

C

D

E

F

A

B

C

D

E

F

REV.	REVISION DESCRIPTION	DATE	APPD
B	PHB-T开口处及倒勾尺寸调整	13/12/26	刘兵
C	调整小压线脚尺寸	17/04/13	吴慧
D	调整倒勾形状	18/09/25	吴慧



NOTES

Used in DL20006-Y or DL20026-Y Series Housing.
 Accepts AWG #28~22 Wire Range.
 0.08~ 0.33 mm² .
 Insulation O. D. =0.9~1.5 mm.
 Material : Phosphor Bronze .
 Finish: Tin plated.



TYPE	Dimension mm				适用线规
	A1	B1	A2	B2	AWG#
PHB-T-02	2.1	2.3	1.6	1.7	24-22
PHB-T-01	2.0	1.8	1.5	1.5	28-24

GENERAL TOLERANCES (UNLESS SPECIFIED)		ZHE JIANG DELI CONNECTORS CO., LTD			
.X: ± 0.25	X°: ± 3.0°	PRODUCT NAME: DL20006 (PHB)-T		TITLE: 2.00 mm Pitch Crimp Terminal	
.XX: ± 0.15	.X°: ± 2.0°	DR: Chen Quan Long		DATE: 20/04/13	
.XXX: ± 0.01	.XX°: ± 1.0°	CHKD: Wu hui		DATE: 20/04/13	
DRAWING NO:		APPD: Ren An De		DATE: 20/04/13	
		SCALE: N/A		PAGE: 1/1	
		UNITS: mm		REV.: D	

REV.	REVISION DESCRIPTION	DATE	APPD



NOTES

Used in DL20001-R Series Housing.
 Accepts AWG #28~22 Wire Range.
 $0.05 \sim 0.22 \text{ mm}^2$.
 Insulation O. D. = $0.9 \sim 1.5$ mm.
 Material : Phosphor Bronze .
 Finish: Tin plated.
 Thickness: 0.2 mm.

GENERAL TOLERANCES (UNLESS SPECIFIED)		ZHE JIANG DELI CONNECTORS CO., LTD	
.X: ± 0.25	X°: $\pm 3.0^\circ$	PRODUCT NAME: DL20001 (PH)-RT	TITLE: 2.00 mm Pitch Wire To Wire Crimp Terminal
.XX: ± 0.15	.X°: $\pm 2.0^\circ$	DR: Chen Quan Long	DATE: 20/01/26
.XXX: ± 0.01	.XX°: $\pm 1.0^\circ$	CHKD: Wu Hui	DATE: 20/01/26
DRAWING NO:		APPD: Ren An De	DATE: 20/01/26
FINISH:		SCALE: N/A	PAGE: 1/1
		UNITS: mm	REV.: A

X-ON Electronics

Largest Supplier of Electrical and Electronic Components

Click to view similar products for [Headers & Wire Housings](#) category:

Click to view products by [DLL](#) manufacturer:

Other Similar products are found below :

[0015917161](#) [0022155065](#) [57102-F02-18ULF](#) [58102-G61-06LF](#) [582553-1](#) [01.001.5753.1](#) [0050291907](#) [02.125.8002.8](#) [609-3404](#) [61062-3](#)
[CSU011177004](#) [622-0430](#) [622-3653LF](#) [63453-116](#) [636-1030](#) [636-1427](#) [636-3427](#) [636-4007](#) [641938-9](#) [65495-038](#) [65692-001LF](#) [65781-018](#)
[65781-047](#) [65817-010LF](#) [65817-015LF](#) [67095-007LF](#) [67601157](#) [68631-112](#) [68645-018](#) [699319-000](#) [70.362.1628.0](#) [70-4210](#) [70-4226B](#) [70-](#)
[4853B](#) [71.350.2428.0](#) [733-134](#) [733-162](#) [760-3052](#) [MHR-64-VUAL](#) [80.063.4001.1](#) [800-90-001-10-001000](#) [801-43-002-10-013000](#)
[801-43-006-10-002000](#) [803-43-024-10-001000](#) [803-93-012-10-001000](#) [8-1437020-4](#) [819-22-004-30-001101](#) [820-22-006-30-001101](#)
[820-22-008-30-001101](#) [821-22-002-10-001101](#)