



**技术特性/Specifications:**

额定电压 Rated voltage: 250V AC, DC  
额定电流 Rated current: 2A AC, DC  
接触电阻 Contact resistance: 20mΩ max  
绝缘电阻 Insulation resistance: 1000MΩ min  
耐压 Withstand voltage: 800V AC/minute  
环境温度 Ambient temperature: -40°C~+105°C  
适用线规 Wire range: AWG#28~#22

| REV. | REVISION DESCRIPTION | DATE | APPD |
|------|----------------------|------|------|
|      |                      |      |      |

### NOTES

Available in 04 through 60 Circuits.  
 Mates with DL20006-XXY Series Housing.  
 Material : LCP UL94V-0.  
 Pin Material : Brass.Tin-plated .

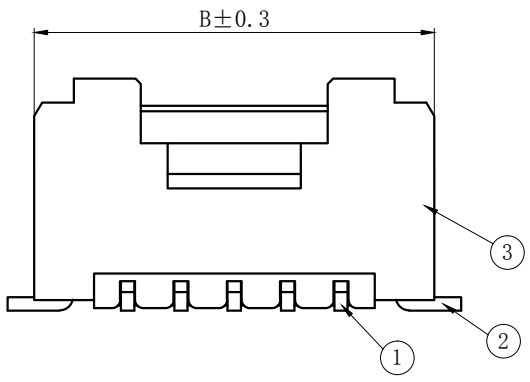

PCB LAYOUT



| Circuits | Product name | Dimension mm |       |       | Circuits | Product name | Dimension mm |       |       |
|----------|--------------|--------------|-------|-------|----------|--------------|--------------|-------|-------|
|          |              | A            | B     | C     |          |              | A            | B     | C     |
| 2X2      | PHB-4AB      | 2.00         | 9.00  | 5.00  | 2X11     | PHB-22AB     | 20.00        | 27.00 | 23.00 |
| 2X3      | PHB-6AB      | 4.00         | 11.00 | 7.00  | 2X12     | PHB-24AB     | 22.00        | 29.00 | 25.00 |
| 2X4      | PHB-8AB      | 6.00         | 13.00 | 9.00  | 2X13     | PHB-26AB     | 24.00        | 31.00 | 27.00 |
| 2X5      | PHB-10AB     | 8.00         | 15.00 | 11.00 | 2X14     | PHB-28AB     | 26.00        | 33.00 | 29.00 |
| 2X6      | PHB-12AB     | 10.00        | 17.00 | 13.00 | 2X15     | PHB-30AB     | 28.00        | 35.00 | 31.00 |
| 2X7      | PHB-14AB     | 12.00        | 19.00 | 15.00 | 2X16     | PHB-32AB     | 30.00        | 37.00 | 33.00 |
| 2X8      | PHB-16AB     | 14.00        | 21.00 | 17.00 | 2X17     | PHB-34AB     | 32.00        | 39.00 | 35.00 |
| 2X9      | PHB-18AB     | 16.00        | 23.00 | 19.00 | -        | -            | -            | -     | -     |
| 2X10     | PHB-20AB     | 18.00        | 25.00 | 21.00 | 2X30     | PHB-60AB     | 58.00        | 65.00 | 61.00 |

|    |    |     |     |    |         |
|----|----|-----|-----|----|---------|
| 3  | ③  | 基座  | LCP | 1  | UL94V-0 |
| 2  | ②  | 焊片  | 黄铜  | 2  | 镀锡      |
| 1  | ①  | 接触件 | 黄铜  | N* | 镀锡      |
| 序号 | 图号 | 名称  | 材料  | 数量 | 附件      |

| GENERAL TOLERANCES (UNLESS SPECIFIED) |              | ZHE JIANG DELI CONNECTORS CO., LTD        |   |
|---------------------------------------|--------------|---|---|
| .X: ± 0.25                            | X°: ± 3.0°   | PRODUCT NAME:<br><b>DL20006 (PHB) -AB</b> | TITLE:<br>2.0 mm Pitch<br>Wire To Board SMT Wafer |
| .XX: ± 0.15                           | .X°: ± 2.0°  | DR: Chen Quan Long                        | DATE: 20/09/03                                    |
| .XXX: ± 0.01                          | .XX°: ± 1.0° | CHKD: Wu Hui                              | DATE: 20/09/03                                    |
| FINISH:                               |              | APPD: Ren An De                           | DATE: 20/09/03                                    |
| DRAWING NO:                           |              |   | SCALE: N/A  |
|                                       |              |   | PAGE: 1/1   |
|                                       |              |   | UNITS: mm   |
|                                       |              |   | REV.: A   |

| REV. | REVISION DESCRIPTION | DATE | APPD |
|------|----------------------|------|------|
|      |                      |      |      |

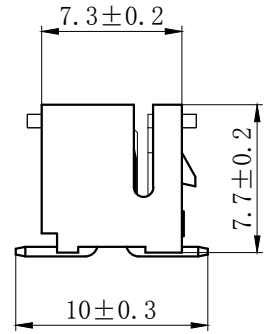
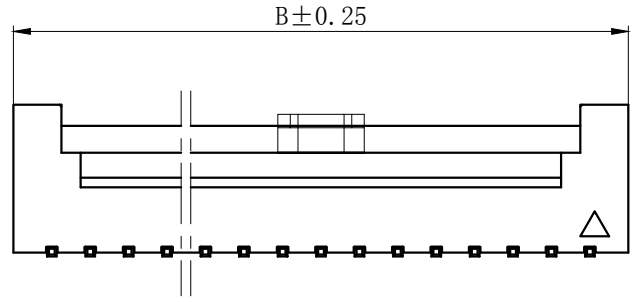

**NOTES**

Available in 04 through 60 Circuits.  
 Mates with DL20006-Y Series Housing.  
 Material : LCP UL94V-0.  
 0.50mm Square Pin.  
 Pin Material : Brass / Tin-Plated.

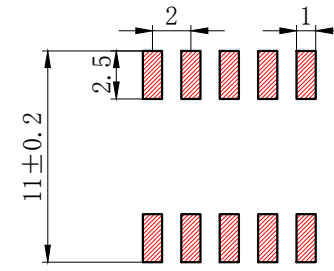
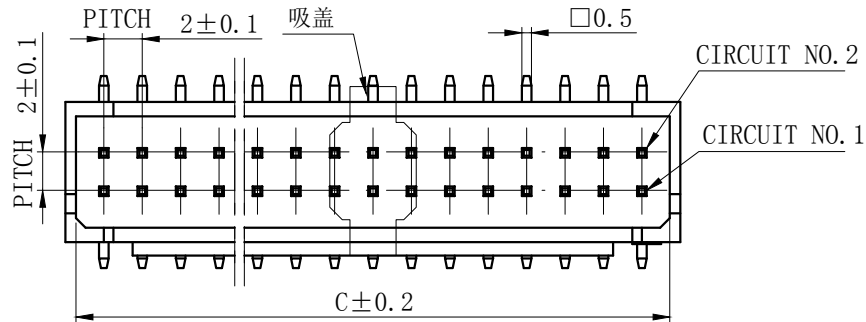

PCB LAYOUT

| Circuits | Product name | Dimension mm |       |       | Circuits | Product name | Dimension mm |       |       | Circuits | Product name | Dimension mm |       |       |
|----------|--------------|--------------|-------|-------|----------|--------------|--------------|-------|-------|----------|--------------|--------------|-------|-------|
|          |              | A            | B     | C     |          |              | A            | B     | C     |          |              | A            | B     | C     |
| 2X2      | PHB-4ABZ     | 2.00         | 6.00  | 4.90  | 2X10     | PHB-20ABZ    | 18.00        | 22.00 | 20.90 | 2X18     | PHB-36ABZ    | 34.00        | 38.00 | 36.90 |
| 2X3      | PHB-6ABZ     | 4.00         | 8.00  | 6.90  | 2X11     | PHB-22ABZ    | 20.00        | 24.00 | 22.90 | 2X19     | PHB-38ABZ    | 36.00        | 40.00 | 38.90 |
| 2X4      | PHB-8ABZ     | 6.00         | 10.00 | 8.90  | 2X12     | PHB-24ABZ    | 22.00        | 26.00 | 24.90 | 2X20     | PHB-40ABZ    | 38.00        | 42.00 | 40.90 |
| 2X5      | PHB-10ABZ    | 8.00         | 12.00 | 10.90 | 2X13     | PHB-26ABZ    | 24.00        | 28.00 | 26.90 | ~        | ~            | ~            | ~     | ~     |
| 2X6      | PHB-12ABZ    | 10.00        | 14.00 | 12.90 | 2X14     | PHB-28ABZ    | 26.00        | 30.00 | 28.90 | 2X30     | PHB-60ABZ    | 58.00        | 62.00 | 60.90 |
| 2X7      | PHB-14ABZ    | 12.00        | 16.00 | 14.90 | 2X15     | PHB-30ABZ    | 28.00        | 32.00 | 30.90 |          |              |              |       |       |
| 2X8      | PHB-16ABZ    | 14.00        | 18.00 | 16.90 | 2X16     | PHB-32ABZ    | 30.00        | 34.00 | 32.90 |          |              |              |       |       |
| 2X9      | PHB-18ABZ    | 16.00        | 20.00 | 18.90 | 2X17     | PHB-34ABZ    | 32.00        | 36.00 | 34.90 |          |              |              |       |       |

| GENERAL TOLERANCES<br>(UNLESS SPECIFIED) |              | ZHE JIANG DELI CONNECTORS CO., LTD |  |
|--|--------------|------------------------------------|--|
| .X: ± 0.25                               | X°: ± 3.0°   | PRODUCT NAME:                      | TITLE: 2.00 mm Pitch Wire To Board Wafer |
| .XX: ± 0.15                              | .X°: ± 2.0°  | DR: Chen Quan Long                 | DATE: 21.7.16                            |
| .XXX: ± 0.01                             | .XX°: ± 1.0° | DATE: 21.7.16                      | PART NO:                                 |
| FINISH:                                  |              | CHKD: Wu Hui                       | SCALE: N/A                               |
| DRAWING NO:                              |              | APPD: Ren An De                    | PAGE: 1/1                                |
|  |              | DATE: 21.7.16                      | UNITS: mm                                |
|  |              |                                    | REV.: A                                  |

|      |                      |      |      |
|------|----------------------|------|------|
| REV. | REVISION DESCRIPTION | DATE | APPD |
|      |                      |      |      |



### NOTES

Available in 04 through 60 Circuits.  
 Mates with DL20006-XXY Series Housing.  
 Material : LCP UL94V-0.  
 Pin Material : Brass. Tin-plated .

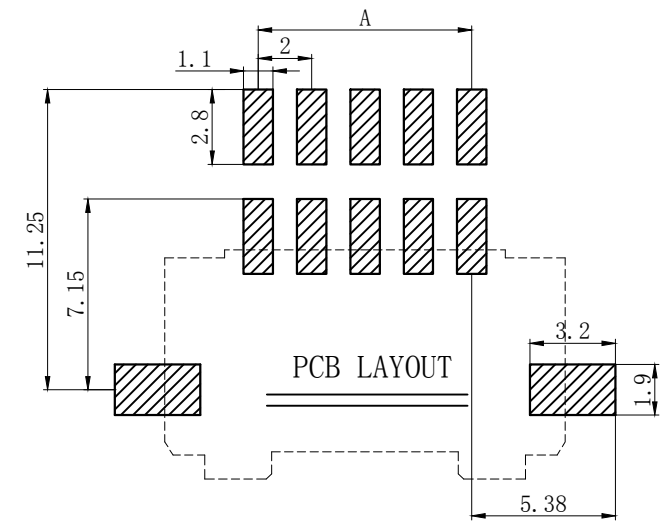

| Type | Product name | Dimension mm |       |       | Type | Product name | Dimension mm |       |       |
|------|--------------|--------------|-------|-------|------|--------------|--------------|-------|-------|
|      |              | A            | B     | C     |      |              | A            | B     | C     |
| 2X2  | PHB-4AWB     | 2.00         | 9.00  | 5.00  | 2X11 | PHB-22AWB    | 20.00        | 27.00 | 23.00 |
| 2X3  | PHB-6AWB     | 4.00         | 11.00 | 7.00  | 2X12 | PHB-24AWB    | 22.00        | 29.00 | 25.00 |
| 2X4  | PHB-8AWB     | 6.00         | 13.00 | 9.00  | 2X13 | PHB-26AWB    | 24.00        | 31.00 | 27.00 |
| 2X5  | PHB-10AWB    | 8.00         | 15.00 | 11.00 | 2X14 | PHB-28AWB    | 26.00        | 33.00 | 29.00 |
| 2X6  | PHB-12AWB    | 10.00        | 17.00 | 13.00 | 2X15 | PHB-32AWB    | 28.00        | 35.00 | 31.00 |
| 2X7  | PHB-14AWB    | 12.00        | 19.00 | 15.00 | 2X16 | PHB-32AWB    | 30.00        | 37.00 | 33.00 |
| 2X8  | PHB-16AWB    | 14.00        | 21.00 | 17.00 | 2X17 | PHB-34AWB    | 32.00        | 39.00 | 35.00 |
| 2X9  | PHB-18AWB    | 16.00        | 23.00 | 19.00 | -    | -            | -            | -     | -     |
| 2X10 | PHB-20AWB    | 18.00        | 25.00 | 21.00 | 2X30 | PHB-60AWB    | 58.00        | 65.00 | 61.00 |

|    |    |     |     |    |         |
|----|----|-----|-----|----|---------|
| 3  | ③  | 基座  | LCP | 1  | UL94V-0 |
| 2  | ②  | 焊片  | 黄铜  | 2  | 镀锡      |
| 1  | ①  | 接触件 | 黄铜  | N* | 镀锡      |
| 序号 | 图号 | 名称  | 材料  | 数量 | 附件      |

|                                       |              |                                    |                |   |           |
|---------------------------------------|--------------|------------------------------------|----------------|---|-----------|
| GENERAL TOLERANCES (UNLESS SPECIFIED) |              | ZHE JIANG DELI CONNECTORS CO., LTD |                |   |           |
| .X: ± 0.25                            | X°: ± 3.0°   | PRODUCT NAME:<br>DL20006 (PHB)-AWB |                | TITLE:<br>2.0 mm Pitch<br>Wire To Board SMT Wafer |           |
| .XX: ± 0.15                           | .X°: ± 2.0°  | DR: Chen Quan Long                 |                | DATE: 20/09/03                                    |           |
| .XXX: ± 0.01                          | .XX°: ± 1.0° | FINISH:<br>_____                   |                | PART NO:  |           |
| DRAWING NO:                           |              | CHKD: Wu Hui                       | DATE: 20/09/03 | SCALE: N/A  | PAGE: 1/1 |
|                                       |              | APPD: Ren An De                    | DATE: 20/09/03 | UNITS: mm   | REV.: A   |

|      |                      |      |      |
|------|----------------------|------|------|
| REV. | REVISION DESCRIPTION | DATE | APPD |
| A    | 3.4调整3.3±0.2         |      | LIU  |

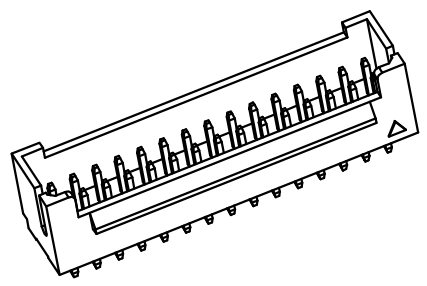
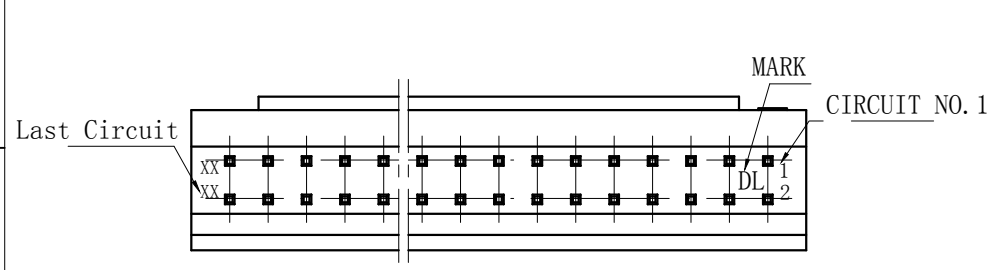

**NOTES**

Available in 04 through 60 Circuits.  
 Mates with DL20006-Y Series Housing.  
 Material : Nylon UL94V-0(2).  
 0.50mm Square Pin.  
 Pin Material : Brass / Tin-Plated.

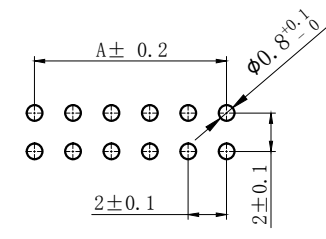
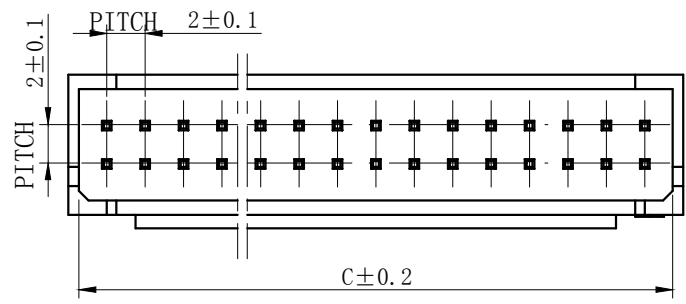
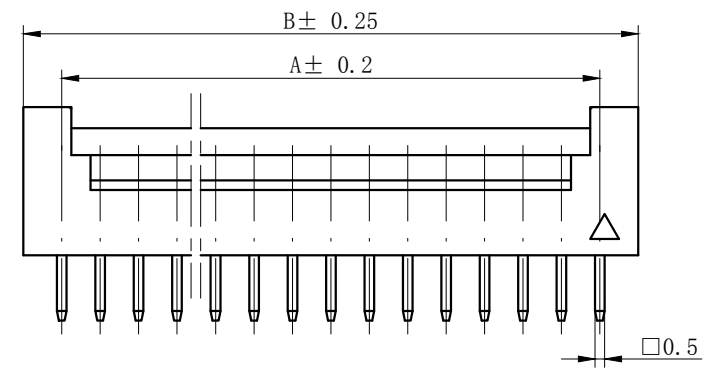

PCB LAYOUT

| Circuits | Product name | Dimension mm |       |       | Circuits | Product name | Dimension mm |       |       | Circuits | Product name | Dimension mm |       |       |
|----------|--------------|--------------|-------|-------|----------|--------------|--------------|-------|-------|----------|--------------|--------------|-------|-------|
|          |              | A            | B     | C     |          |              | A            | B     | C     |          |              | A            | B     | C     |
| 2X2      | PHB-4A       | 2.00         | 6.00  | 4.90  | 2X10     | PHB-20A      | 18.00        | 22.00 | 20.90 | 2X18     | PHB-36A      | 34.00        | 38.00 | 36.90 |
| 2X3      | PHB-6A       | 4.00         | 8.00  | 6.90  | 2X11     | PHB-22A      | 20.00        | 24.00 | 22.90 | 2X19     | PHB-38A      | 36.00        | 40.00 | 38.90 |
| 2X4      | PHB-8A       | 6.00         | 10.00 | 8.90  | 2X12     | PHB-24A      | 22.00        | 26.00 | 24.90 | 2X20     | PHB-40A      | 38.00        | 42.00 | 40.90 |
| 2X5      | PHB-10A      | 8.00         | 12.00 | 10.90 | 2X13     | PHB-26A      | 24.00        | 28.00 | 26.90 | ~        | ~            | ~            | ~     | ~     |
| 2X6      | PHB-12A      | 10.00        | 14.00 | 12.90 | 2X14     | PHB-28A      | 26.00        | 30.00 | 28.90 | 2X30     | PHB-60A      | 58.00        | 62.00 | 60.90 |
| 2X7      | PHB-14A      | 12.00        | 16.00 | 14.90 | 2X15     | PHB-30A      | 28.00        | 32.00 | 30.90 |          |              |              |       |       |
| 2X8      | PHB-16A      | 14.00        | 18.00 | 16.90 | 2X16     | PHB-32A      | 30.00        | 34.00 | 32.90 |          |              |              |       |       |
| 2X9      | PHB-18A      | 16.00        | 20.00 | 18.90 | 2X17     | PHB-34A      | 32.00        | 36.00 | 34.90 |          |              |              |       |       |

|  |              |  |  |                                  |  |  |  |
|--|--------------|--|--|----------------------------------|--|--|--|
| GENERAL TOLERANCES<br>(UNLESS SPECIFIED) |              | 浙江德利接插件有限公司<br>ZHEJIANG DELI CONNECTORS CO., LTD |  | PRODUCT NAME:<br>DL20006 (PHB)-A |  | TITLE:<br>2.00 mm Pitch<br>Wire To Board Wafer |  |
| .X: ± 0.25                               | X°: ± 3.0°   |  |  | DR: Yuan Jun Rong                |  | DATE: 20.11.30                                 |  |
| .XX: ± 0.15                              | .X°: ± 2.0°  | CHKD: Wu Hui                                     |  | DATE: 20.11.30                   |  | SCALE: N/A                                     |  |
| .XXX: ± 0.01                             | .XX°: ± 1.0° | APPD: Ren An De                                  |  | DATE: 20.11.30                   |  | UNITS: mm                                      |  |
| FINISH:                                  |              | DRAWING NO:                                      |  |                                  |  | PAGE: 1/1                                      |  |
|  |              |  |  |                                  |  | REV.: A  |  |

|      |                      |      |      |
|------|----------------------|------|------|
| REV. | REVISION DESCRIPTION | DATE | APPD |
|      |                      |      |      |

# NOTES

Available in 04 through 60 Circuits.  
 Mates with DL20006-Y Series Housing.  
 Material : Nylon UL94V-0(2).  
 0.50mm Square Pin.  
 Pin Material : Brass / Tin-Plated.

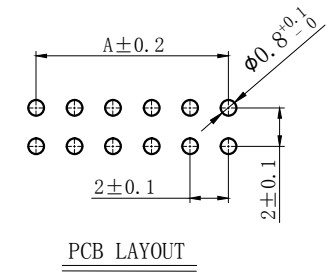
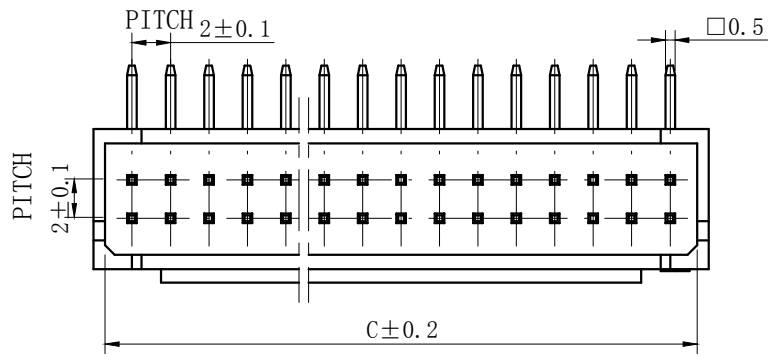

| Circuits | Product name | Dimension mm |       |       | Circuits | Product name | Dimension mm |       |       | Circuits | Product name | Dimension mm |       |       |
|----------|--------------|--------------|-------|-------|----------|--------------|--------------|-------|-------|----------|--------------|--------------|-------|-------|
|          |              | A            | B     | C     |          |              | A            | B     | C     |          |              | A            | B     | C     |
| 2X2      | PHB-4AW      | 2.00         | 6.00  | 4.90  | 2X10     | PHB-20AW     | 18.00        | 22.00 | 20.90 | 2X18     | PHB-36AW     | 34.00        | 38.00 | 36.90 |
| 2X3      | PHB-6AW      | 4.00         | 8.00  | 6.90  | 2X11     | PHB-22AW     | 20.00        | 24.00 | 22.90 | 2X19     | PHB-38AW     | 36.00        | 40.00 | 38.90 |
| 2X4      | PHB-8AW      | 6.00         | 10.00 | 8.90  | 2X12     | PHB-24AW     | 22.00        | 26.00 | 24.90 | 2X20     | PHB-40AW     | 38.00        | 42.00 | 40.90 |
| 2X5      | PHB-10AW     | 8.00         | 12.00 | 10.90 | 2X13     | PHB-26AW     | 24.00        | 28.00 | 26.90 | ~        | ~            | ~            | ~     | ~     |
| 2X6      | PHB-12AW     | 10.00        | 14.00 | 12.90 | 2X14     | PHB-28AW     | 26.00        | 30.00 | 28.90 | 2X30     | PHB-60AW     | 58.00        | 62.00 | 60.90 |
| 2X7      | PHB-14AW     | 12.00        | 16.00 | 14.90 | 2X15     | PHB-30AW     | 28.00        | 32.00 | 30.90 |          |              |              |       |       |
| 2X8      | PHB-16AW     | 14.00        | 18.00 | 16.90 | 2X16     | PHB-32AW     | 30.00        | 34.00 | 32.90 |          |              |              |       |       |
| 2X9      | PHB-18AW     | 16.00        | 20.00 | 18.90 | 2X17     | PHB-34AW     | 32.00        | 36.00 | 34.90 |          |              |              |       |       |

|                                       |              |  |  |
|---------------------------------------|--------------|--|--|
| GENERAL TOLERANCES (UNLESS SPECIFIED) |              | 浙江德利接插件有限公司<br>ZHE JIANG DELI CONNECTORS CO.,LTD |  |
| .X: ± 0.25                            | X°: ± 3.0°   | PRODUCT NAME:<br><b>DL20006 (PHB)-AW</b>         | TITLE:<br>2.00 mm Pitch<br>Wire To Board Wafer |
| .XX: ± 0.15                           | .X°: ± 2.0°  | DR: Chen Quan Long                               | DATE: 20.11.30                                 |
| .XXX: ± 0.01                          | .XX°: ± 1.0° | CHKD: Wu Hui                                     | DATE: 20.11.30                                 |
| DRAWING NO:                           |              | APPD: Ren An De                                  | DATE: 20.11.30                                 |
|                                       |              | SCALE: N/A                                       | PAGE: 1/1                                      |
|                                       |              | UNITS: mm  | REV.: A  |

|      |                      |      |      |
|------|----------------------|------|------|
| REV. | REVISION DESCRIPTION | DATE | APPD |
|      |                      |      |      |

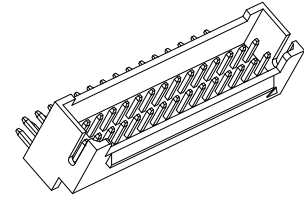
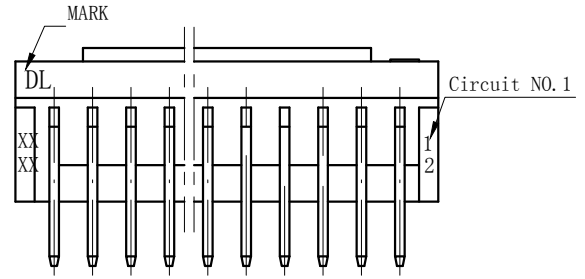

### NOTES

Available in 04 through 60 Circuits.  
 Mates with DL20006-Y Series Housing.  
 Material : Nylon UL94V-0(2).  
 0.50mm Square Pin.  
 Pin Material : Brass / Tin-Plated.

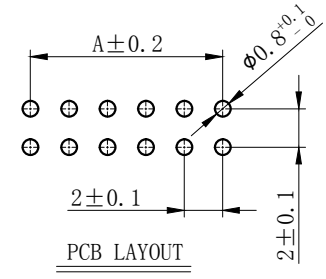
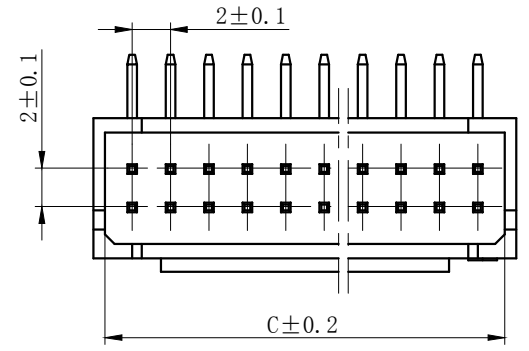
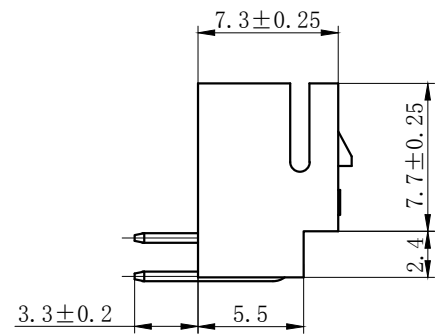
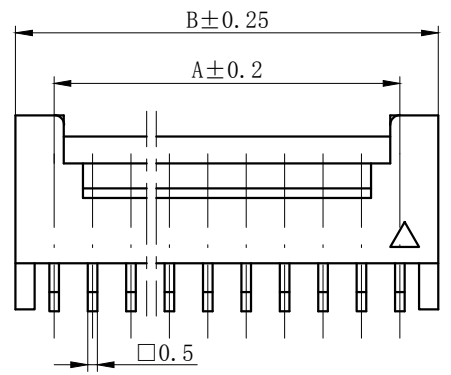

| Circuits | Product name | Dimension mm |       |       | Circuits | Product name | Dimension mm |       |       | Circuits | Product name | Dimension mm |       |       |
|----------|--------------|--------------|-------|-------|----------|--------------|--------------|-------|-------|----------|--------------|--------------|-------|-------|
|          |              | A            | B     | C     |          |              | A            | B     | C     |          |              | A            | B     | C     |
| 2X2      | PHB-4AWD     | 2.00         | 6.00  | 4.90  | 2X10     | PHB-20AWD    | 18.00        | 22.00 | 20.90 | 2X18     | PHB-36AWD    | 34.00        | 38.00 | 36.90 |
| 2X3      | PHB-6AWD     | 4.00         | 8.00  | 6.90  | 2X11     | PHB-22AWD    | 20.00        | 24.00 | 22.90 | 2X19     | PHB-38AWD    | 36.00        | 40.00 | 38.90 |
| 2X4      | PHB-8AWD     | 6.00         | 10.00 | 8.90  | 2X12     | PHB-24AWD    | 22.00        | 26.00 | 24.90 | 2X20     | PHB-40AWD    | 38.00        | 42.00 | 40.90 |
| 2X5      | PHB-10AWD    | 8.00         | 12.00 | 10.90 | 2X13     | PHB-26AWD    | 24.00        | 28.00 | 26.90 | ~        | ~            | ~            | ~     | ~     |
| 2X6      | PHB-12AWD    | 10.00        | 14.00 | 12.90 | 2X14     | PHB-28AWD    | 26.00        | 30.00 | 28.90 | 2X30     | PHB-60AWD    | 58.00        | 62.00 | 60.90 |
| 2X7      | PHB-14AWD    | 12.00        | 16.00 | 14.90 | 2X15     | PHB-30AWD    | 28.00        | 32.00 | 30.90 |          |              |              |       |       |
| 2X8      | PHB-16AWD    | 14.00        | 18.00 | 16.90 | 2X16     | PHB-32AWD    | 30.00        | 34.00 | 32.90 |          |              |              |       |       |
| 2X9      | PHB-18AWD    | 16.00        | 20.00 | 18.90 | 2X17     | PHB-34AWD    | 32.00        | 36.00 | 34.90 |          |              |              |       |       |

|  |              |  |  |
|--|--------------|--|--|
| GENERAL TOLERANCES<br>(UNLESS SPECIFIED) |              | 浙江德利接插件有限公司<br>ZHEJIANG DELI CONNECTORS CO., LTD |  |
| .X: ± 0.25                               | X°: ± 3.0°   | PRODUCT NAME:<br><b>DL20006 (PHB)-AWD</b>        | TITLE:<br>2.00 mm Pitch<br>Wire To Board Wafer |
| .XX: ± 0.15                              | .X°: ± 2.0°  | DR: Chen Quan Long                               | DATE: 20.11.30                                 |
| .XXX: ± 0.01                             | .XX°: ± 1.0° | CHKD: Wu Hui                                     | DATE: 20.11.30                                 |
| FINISH:                                  |              | APPD: Ren An De                                  | DATE: 20.11.30                                 |
| DRAWING NO:                              |              |  | SCALE: N/A                                     |
|  |              |  | PAGE: 1/1                                      |
|  |              |  | UNITS: mm                                      |
|  |              |  | REV.: A  |

|      |                      |      |      |
|------|----------------------|------|------|
| REV. | REVISION DESCRIPTION | DATE | APPD |
|      |                      |      |      |

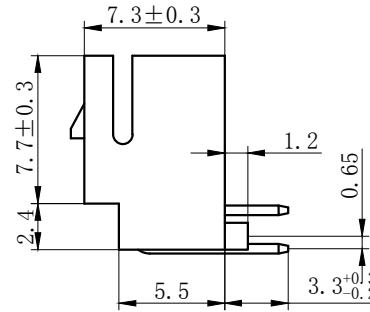

### NOTES

Available in 04 through 60 Circuits.  
 Mates with DL20006-Y Series Housing.  
 Material : Nylon UL94V-0(2).  
 0.50mm Square Pin.  
 Pin Material : Brass / Tin-Plated.

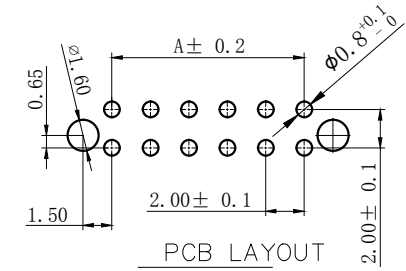

| Circuits | Product name | Dimension mm |       |       | Circuits | Product name | Dimension mm |       |       | Circuits | Product name | Dimension mm |       |       |
|----------|--------------|--------------|-------|-------|----------|--------------|--------------|-------|-------|----------|--------------|--------------|-------|-------|
|          |              | A            | B     | C     |          |              | A            | B     | C     |          |              | A            | B     | C     |
| 2X2      | PHB-4AWD-S   | 2.00         | 6.00  | 4.90  | 2X10     | PHB-20AWD-S  | 18.00        | 22.00 | 20.90 | 2X18     | PHB-36AWD-S  | 34.00        | 38.00 | 36.90 |
| 2X3      | PHB-6AWD-S   | 4.00         | 8.00  | 6.90  | 2X11     | PHB-22AWD-S  | 20.00        | 24.00 | 22.90 | 2X19     | PHB-38AWD-S  | 36.00        | 40.00 | 38.90 |
| 2X4      | PHB-8AWD-S   | 6.00         | 10.00 | 8.90  | 2X12     | PHB-24AWD-S  | 22.00        | 26.00 | 24.90 | 2X20     | PHB-40AWD-S  | 38.00        | 42.00 | 40.90 |
| 2X5      | PHB-10AWD-S  | 8.00         | 12.00 | 10.90 | 2X13     | PHB-26AWD-S  | 24.00        | 28.00 | 26.90 | ~        | ~            | ~            | ~     | ~     |
| 2X6      | PHB-12AWD-S  | 10.00        | 14.00 | 12.90 | 2X14     | PHB-28AWD-S  | 26.00        | 30.00 | 28.90 | 2X30     | PHB-60AWD-S  | 58.00        | 62.00 | 60.90 |
| 2X7      | PHB-14AWD-S  | 12.00        | 16.00 | 14.90 | 2X15     | PHB-30AWD-S  | 28.00        | 32.00 | 30.90 |          |              |              |       |       |
| 2X8      | PHB-16AWD-S  | 14.00        | 18.00 | 16.90 | 2X16     | PHB-32AWD-S  | 30.00        | 34.00 | 32.90 |          |              |              |       |       |
| 2X9      | PHB-18AWD-S  | 16.00        | 20.00 | 18.90 | 2X17     | PHB-34AWD-S  | 32.00        | 36.00 | 34.90 |          |              |              |       |       |

|  |              |   |  |
|--|--------------|---|--|
| GENERAL TOLERANCES<br>(UNLESS SPECIFIED) |              | <b>浙江德利接插件有限公司</b><br>ZHEJIANG DELI CONNECTORS CO., LTD |  |
| .X: ± 0.25                               | .X°: ± 3.0°  | PRODUCT NAME:<br><b>DL20006 (PHB)-AWD-S</b>             | TITLE:<br>2.00 mm Pitch<br>Wire To Board Wafer |
| .XX: ± 0.15                              | .X°: ± 2.0°  | DR: Ke Xian Qiang                                       | DATE: 23.10.20                                 |
| .XXX: ± 0.01                             | .XX°: ± 1.0° | CHKD: Liu Bing  | DATE: 23.10.20                                 |
| FINISH:                                  |              | APPD: Ren An De   | DATE: 23.10.20                                 |
| DRAWING NO:                              |              | PART NO:  |  |
|  |              | SCALE: N/A  | PAGE: 1/1                                      |
|  |              | UNITS: mm   | REV.: A  |



|      |                      |      |      |
|------|----------------------|------|------|
| REV. | REVISION DESCRIPTION | DATE | APPD |
|      |                      |      |      |

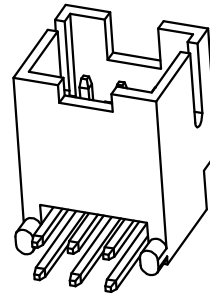
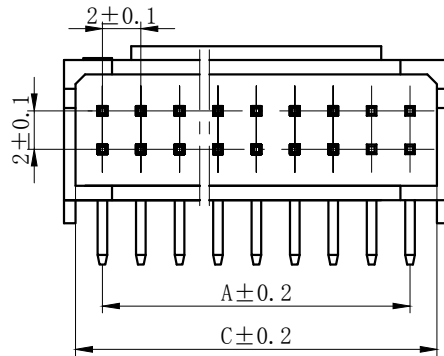
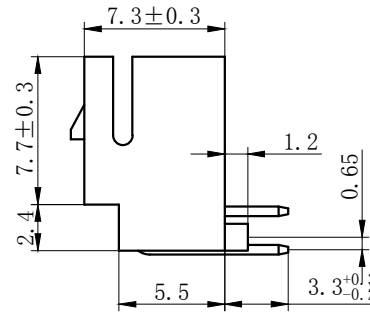
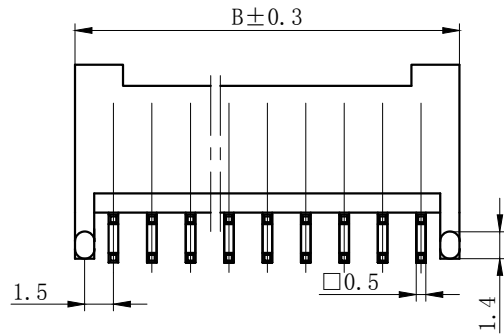

## NOTES

Available in 04 through 60 Circuits.  
 Mates with DL20006-Y Series Housing.  
 Material : Nylon UL94V-0(2).  
 0.50mm Square Pin.  
 Pin Material : Brass / Tin-Plated.

COLOR(颜色): DL20006(PHB)-AWD-S-XX

RE:red(红色); BR:brown(棕色); GY:gray(灰色);  
 BK:black(黑色); OR:orange(橙色); BL:blue(蓝色);  
 GE:green(绿色); OW:off-white(米黄色);  
 PU:purple(紫色); PI:pink(粉色); YE:yellow(黄色);  
 TR:transparent(透明色); OT:other(其它)

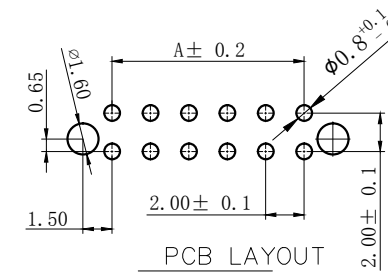

| Circuits | Product name   | Dimension mm |       |       | Circuits | Product name   | Dimension mm |       |       | Circuits | Product name   | Dimension mm |       |       |
|----------|----------------|--------------|-------|-------|----------|----------------|--------------|-------|-------|----------|----------------|--------------|-------|-------|
|          |                | A            | B     | C     |          |                | A            | B     | C     |          |                | A            | B     | C     |
| 2X2      | PHB-4AWD-S-XX  | 2.00         | 6.00  | 4.90  | 2X10     | PHB-20AWD-S-XX | 18.00        | 22.00 | 20.90 | 2X18     | PHB-36AWD-S-XX | 34.00        | 38.00 | 36.90 |
| 2X3      | PHB-6AWD-S-XX  | 4.00         | 8.00  | 6.90  | 2X11     | PHB-22AWD-S-XX | 20.00        | 24.00 | 22.90 | 2X19     | PHB-38AWD-S-XX | 36.00        | 40.00 | 38.90 |
| 2X4      | PHB-8AWD-S-XX  | 6.00         | 10.00 | 8.90  | 2X12     | PHB-24AWD-S-XX | 22.00        | 26.00 | 24.90 | 2X20     | PHB-40AWD-S-XX | 38.00        | 42.00 | 40.90 |
| 2X5      | PHB-10AWD-S-XX | 8.00         | 12.00 | 10.90 | 2X13     | PHB-26AWD-S-XX | 24.00        | 28.00 | 26.90 | ~        | ~              | ~            | ~     | ~     |
| 2X6      | PHB-12AWD-S-XX | 10.00        | 14.00 | 12.90 | 2X14     | PHB-28AWD-S-XX | 26.00        | 30.00 | 28.90 | 2X30     | PHB-60AWD-S-XX | 58.00        | 62.00 | 60.90 |
| 2X7      | PHB-14AWD-S-XX | 12.00        | 16.00 | 14.90 | 2X15     | PHB-30AWD-S-XX | 28.00        | 32.00 | 30.90 |          |                |              |       |       |
| 2X8      | PHB-16AWD-S-XX | 14.00        | 18.00 | 16.90 | 2X16     | PHB-32AWD-S-XX | 30.00        | 34.00 | 32.90 |          |                |              |       |       |
| 2X9      | PHB-18AWD-S-XX | 16.00        | 20.00 | 18.90 | 2X17     | PHB-34AWD-S-XX | 32.00        | 36.00 | 34.90 |          |                |              |       |       |

|  |              |   |  |
|--|--------------|---|--|
| GENERAL TOLERANCES<br>(UNLESS SPECIFIED) |              | 浙江德利接插件有限公司<br>ZHEJIANG DELI CONNECTORS CO.,LTD |  |
| .X: ± 0.25                               | X°: ± 3.0°   | PRODUCT NAME:<br>DL20006(PHB)-AWD-S-XX          | TITLE:<br>2.00 mm Pitch<br>Wire To Board Wafer |
| .XX: ± 0.15                              | .X°: ± 2.0°  | DR: Ke Xian Qiang                               | DATE:23.10.20                                  |
| .XXX: ± 0.01                             | .XX°: ± 1.0° | CHKD: Liu Bing                                  | DATE:23.10.20                                  |
| FINISH:                                  |              | APPD:Ren An De                                  | DATE:23.10.20                                  |
| DRAWING NO:                              |              | PART NO:  |  |
|  |              | SCALE: N/A                                      | PAGE: 1/1                                      |
|  |              | UNITS: mm                                       | REV.: A  |

|      |                      |      |      |
|------|----------------------|------|------|
| REV. | REVISION DESCRIPTION | DATE | APPD |
|      |                      |      |      |

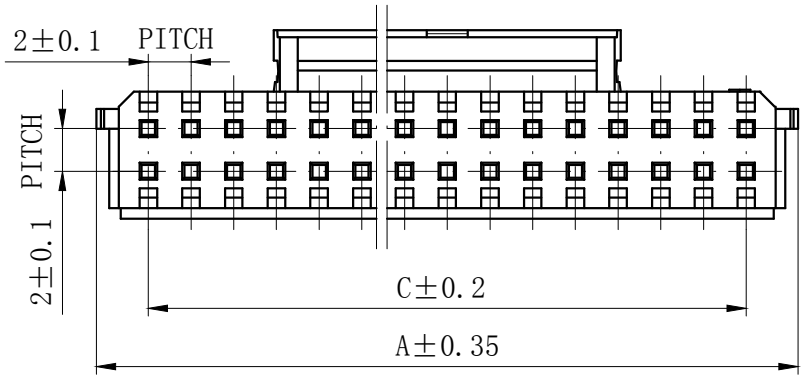

NOTES  
 Available in 04 through 60 Circuits.  
 Match with DL20006 series housing  
 Material : Nylon UL94V-0(2).  
 Accepts DL20006-T Crimp Terminal.

| Circuits | Product name | Dimension mm |       |       | Circuits | Product name | Dimension mm |       |       | Circuits | Product name | Dimension mm |       |       |
|----------|--------------|--------------|-------|-------|----------|--------------|--------------|-------|-------|----------|--------------|--------------|-------|-------|
|          |              | A            | B     | C     |          |              | A            | B     | C     |          |              | A            | B     | C     |
| 2X2      | PHB-4Y       | 7.00         | 4.70  | 2.00  | 2X10     | PHB-20Y      | 23.00        | 20.70 | 18.00 | 2X18     | PHB-36Y      | 39.00        | 36.70 | 34.00 |
| 2X3      | PHB-6Y       | 9.00         | 6.70  | 4.00  | 2X11     | PHB-22Y      | 25.00        | 22.70 | 20.00 | 2X19     | PHB-38Y      | 41.00        | 38.70 | 36.00 |
| 2X4      | PHB-8Y       | 11.00        | 8.70  | 6.00  | 2X12     | PHB-24Y      | 27.00        | 24.70 | 22.00 | 2X20     | PHB-40Y      | 43.00        | 40.70 | 38.00 |
| 2X5      | PHB-10Y      | 13.00        | 10.70 | 8.00  | 2X13     | PHB-26Y      | 29.00        | 26.70 | 24.00 | 2X21     | PHB-42Y      | 45.00        | 42.70 | 40.00 |
| 2X6      | PHB-12Y      | 15.00        | 12.70 | 10.00 | 2X14     | PHB-28Y      | 31.00        | 28.70 | 26.00 | 2X22     | PHB-44Y      | 47.00        | 44.70 | 42.00 |
| 2X7      | PHB-14Y      | 17.00        | 14.70 | 12.00 | 2X15     | PHB-30Y      | 33.00        | 30.70 | 28.00 | ~        | ~            | ~            | ~     | ~     |
| 2X8      | PHB-16Y      | 19.00        | 16.70 | 14.00 | 2X16     | PHB-32Y      | 35.00        | 32.70 | 30.00 | 2X30     | PHB-60Y      | 63.00        | 60.70 | 58.00 |
| 2X9      | PHB-18Y      | 21.00        | 18.70 | 16.00 | 2X17     | PHB-34Y      | 37.00        | 34.70 | 32.00 |          |              |              |       |       |

|  |              |  |                                     |
|--|--------------|--|-------------------------------------|
| GENERAL TOLERANCES<br>(UNLESS SPECIFIED) |              | 浙江德利接插件有限公司<br>ZHE JIANG DELI CONNECTORS CO.,LTD |                                     |
| .X: ± 0.25                               | X°: ± 3.0°   | PRODUCT NAME:<br><b>DL20006 (PHB)-Y</b>          | TITLE:<br>2.00 mm Pitch Housing     |
| .XX: ± 0.15                              | .X°: ± 2.0°  | DR: Yuan Jun Rong                                | DATE:20.11.30                       |
| .XXX: ± 0.01                             | .XX°: ± 1.0° | CHKD: Wu Hui                                     | DATE:20.11.30                       |
| FINISH:<br>_____                         |              | APPD: Ren An De                                  | DATE:20.11.30                       |
| DRAWING NO:                              |              |  | PART NO:<br>SCALE: N/A<br>UNITS: mm |
|  |              |  | PAGE: 1/1<br>REV.: B                |

1

2

3

4

5

6

7

8

| REV. | REVISION DESCRIPTION | DATE | APPD |
|------|----------------------|------|------|
|      |                      |      |      |

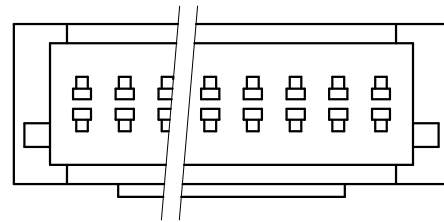
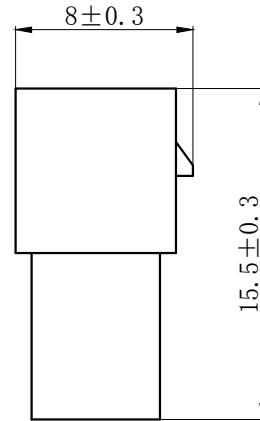
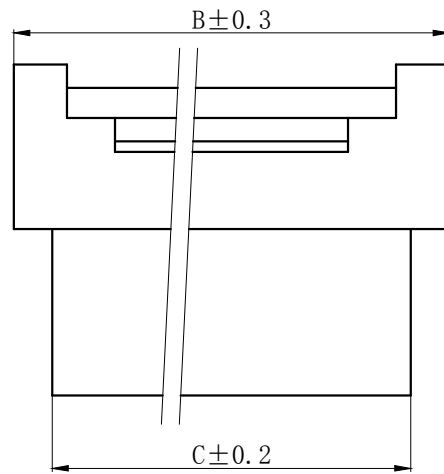

## NOTES

Available in 04 through 60 Circuits.  
 Mates with DL20006-Y Series Housing.  
 Material : Nylon UL94V-0(2).  
 Accepts DL20006-RT Crimp Terminal.

| Circuits | Product name | Dimension mm |       |       | Circuits | Product name | Dimension mm |       |       | Circuits | Product name | Dimension mm |       |       |
|----------|--------------|--------------|-------|-------|----------|--------------|--------------|-------|-------|----------|--------------|--------------|-------|-------|
|          |              | A            | B     | C     |          |              | A            | B     | C     |          |              | A            | B     | C     |
| 2X2      | PHB-4R       | 2.00         | 8.40  | 4.80  | 2X10     | PHB-20R      | 18.00        | 24.40 | 20.80 | 2X18     | PHB-36R      | 34.00        | 40.40 | 36.80 |
| 2X3      | PHB-6R       | 4.00         | 10.40 | 6.80  | 2X11     | PHB-22R      | 20.00        | 26.40 | 22.80 | 2X19     | PHB-38R      | 36.00        | 42.40 | 38.80 |
| 2X4      | PHB-8R       | 6.00         | 12.40 | 8.80  | 2X12     | PHB-24R      | 22.00        | 28.40 | 24.80 | 2X20     | PHB-40R      | 38.00        | 44.40 | 40.80 |
| 2X5      | PHB-10R      | 8.00         | 14.40 | 10.80 | 2X13     | PHB-26R      | 24.00        | 30.40 | 26.80 | ~        | ~            | ~            | ~     | ~     |
| 2X6      | PHB-12R      | 10.00        | 16.40 | 12.80 | 2X14     | PHB-28R      | 26.00        | 32.40 | 28.80 | 2X30     | PHB-60R      | 58.00        | 64.40 | 60.80 |
| 2X7      | PHB-14R      | 12.00        | 18.40 | 14.80 | 2X15     | PHB-30R      | 28.00        | 34.40 | 30.80 |          |              |              |       |       |
| 2X8      | PHB-16R      | 14.00        | 20.40 | 16.80 | 2X16     | PHB-32R      | 30.00        | 36.40 | 32.80 |          |              |              |       |       |
| 2X9      | PHB-18R      | 16.00        | 22.40 | 18.80 | 2X17     | PHB-34R      | 32.00        | 38.40 | 34.80 |          |              |              |       |       |

GENERAL TOLERANCES  
(UNLESS SPECIFIED)

|              |                |
|--------------|----------------|
| .X: ± 0.25   | .X° : ± 3.0°   |
| .XX: ± 0.15  | .XX° : ± 2.0°  |
| .XXX: ± 0.01 | .XXX° : ± 1.0° |

FINISH: \_\_\_\_\_

DRAWING NO:

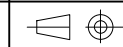

浙江德利接插件有限公司  
ZHE JIANG DELI CONNECTORS CO., LTD

PRODUCT NAME:  
DL20006(PHB)-R

DR: Chen Quan Long DATE: 20.11.30

CHKD: Wu Hui DATE: 20.11.30

APPD: Ren An De DATE: 20.11.30

TITLE: 2.00 mm Pitch  
Wire To Wire Housing

PART NO:

SCALE: N/A PAGE: 1/1

UNITS: mm REV.: A

1

2

3

4

5

6

7

8

A

B

C

D

E

F

A

B

C

D

E

F

| REV. | REVISION DESCRIPTION | DATE     | APPD |
|------|----------------------|----------|------|
| B    | PHB-T开口处及倒勾尺寸调整      | 13/12/26 | 刘兵   |
| C    | 调整小压线脚尺寸             | 17/04/13 | 吴慧   |
| D    | 调整倒勾形状               | 18/09/25 | 吴慧   |



## NOTES

Used in DL20006-Y or DL20026-Y Series Housing.  
 Accepts AWG #28~22 Wire Range.  
 0.08~ 0.33 mm<sup>2</sup> .  
 Insulation O.D.=0.9~1.5 mm.  
 Material : Phosphor Bronze .  
 Finish: Tin plated.



| TYPE     | Dimension mm |     |     |     | 适用线规  |
|----------|--------------|-----|-----|-----|-------|
|          | A1           | B1  | A2  | B2  | AWG#  |
| PHB-T-02 | 2.1          | 2.3 | 1.6 | 1.7 | 24-22 |
| PHB-T-01 | 2.0          | 1.8 | 1.5 | 1.5 | 28-24 |

| GENERAL TOLERANCES (UNLESS SPECIFIED) |              | ZHE JIANG DELI CONNECTORS CO., LTD |                                     |
|---------------------------------------|--------------|------------------------------------|-------------------------------------|
| .X: ± 0.25                            | X°: ± 3.0°   | PRODUCT NAME:                      | TITLE: 2.00 mm Pitch Crimp Terminal |
| .XX: ± 0.15                           | .X°: ± 2.0°  | DL20006 (PHB)-T                    |                                     |
| .XXX: ± 0.01                          | .XX°: ± 1.0° | DR: Chen Quan Long                 | DATE: 20/04/13                      |
| FINISH:                               |              | CHKD: Wu hui                       | DATE: 20/04/13                      |
| DRAWING NO:                           |              | APPD: Ren An De                    | DATE: 20/04/13                      |
|                                       |              | SCALE: N/A                         | PAGE: 1/1                           |
|                                       |              | UNITS: mm                          | REV.: D                             |

| REV. | REVISION DESCRIPTION | DATE | APPD |
|------|----------------------|------|------|
|      |                      |      |      |



## NOTES

Used in DL20001-R Series Housing.  
 Accepts AWG #28~22 Wire Range.  
 $0.05 \sim 0.22 \text{ mm}^2$  .  
 Insulation O. D. =  $0.9 \sim 1.5$ mm.  
 Material : Phosphor Bronze .  
 Finish: Tin plated.  
 Thickness:  $0.2$  mm.

|                                       |                       |   |  |
|---------------------------------------|-----------------------|---|--|
| GENERAL TOLERANCES (UNLESS SPECIFIED) |                       | ZHE JIANG DELI CONNECTORS CO., LTD      |  |
| .X: $\pm 0.25$                        | X°: $\pm 3.0^\circ$   | PRODUCT NAME:<br><b>DL20001 (PH)-RT</b> | TITLE:<br>2.00 mm Pitch<br>Wire To Wire Crimp Terminal |
| .XX: $\pm 0.15$                       | .X°: $\pm 2.0^\circ$  | DR: Chen Quan Long                      | DATE: 20/01/26   |
| .XXX: $\pm 0.01$                      | .XX°: $\pm 1.0^\circ$ | CHKD: Wu Hui                            | DATE: 20/01/26   |
| DRAWING NO:                           |                       | APPD: Ren An De                         | DATE: 20/01/26   |
| FINISH:                               |                       | SCALE: N/A                              | PAGE: 1/1  |
|                                       |                       | UNITS: mm                               | REV.: A  |

## X-ON Electronics

Largest Supplier of Electrical and Electronic Components

*Click to view similar products for [Headers & Wire Housings](#) category:*

*Click to view products by [DLL](#) manufacturer:*

Other Similar products are found below :

[0015917161](#) [0022155065](#) [57102-F02-18ULF](#) [58102-G61-06LF](#) [582553-1](#) [01.001.5753.1](#) [0050291907](#) [02.125.8002.8](#) [609-3404](#) [61062-3](#)  
[CSU011177004](#) [622-0430](#) [622-3653LF](#) [63453-116](#) [636-1030](#) [636-1427](#) [636-3427](#) [636-4007](#) [641938-9](#) [65495-038](#) [65692-001LF](#) [65781-018](#)  
[65781-047](#) [65817-010LF](#) [65817-015LF](#) [67095-007LF](#) [67601157](#) [68631-112](#) [68645-018](#) [699319-000](#) [70.362.1628.0](#) [70-4210](#) [70-4226B](#) [70-](#)  
[4853B](#) [71.350.2428.0](#) [733-134](#) [733-162](#) [760-3052](#) [MHR-64-VUAL](#) [80.063.4001.1](#) [800-90-001-10-001000](#) [801-43-002-10-013000](#)  
[801-43-006-10-002000](#) [803-43-024-10-001000](#) [803-93-012-10-001000](#) [8-1437020-4](#) [819-22-004-30-001101](#) [820-22-006-30-001101](#)  
[820-22-008-30-001101](#) [821-22-002-10-001101](#)