

技术特性/Specifications:

额定电压 Rated voltage: 250V AC, DC
额定电流 Rated current: 3A AC, DC
接触电阻 Contact resistance: 20m Ω max
绝缘电阻 Insulation resistance: 1000M Ω min
耐压 Withstand voltage: 1000V AC/minute
环境温度 Ambient temperature: -40 $^{\circ}$ C~+105 $^{\circ}$ C
适用线规 Wire range: AWG#28~#22

| | | | |
|------|----------------------|------|------|
| REV. | REVISION DESCRIPTION | DATE | APPD |
| | | | |

NOTES

Available in 04 through 60 Circuits.
 Mates with DL20004-Y Series Housing.
 Material : LCP UL94V-0.
 Pin Material : Brass.Tin-plated .

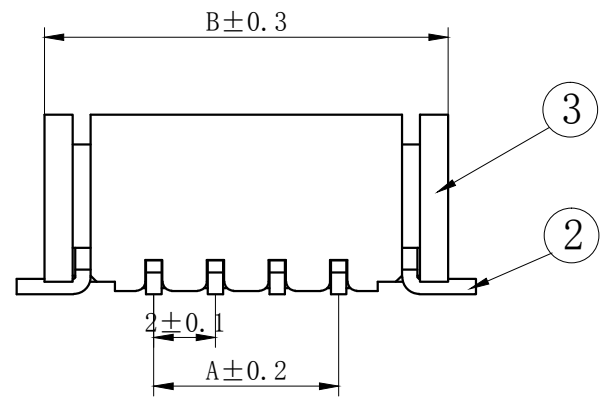

| | | | | | |
|----|----|-----|-----|----|---------|
| 3 | ③ | 基座 | LCP | 1 | UL94V-0 |
| 2 | ② | 焊片 | 黄铜 | 2 | 镀锡 |
| 1 | ① | 接触件 | 黄铜 | N | 镀锡 |
| 序号 | 图号 | 名称 | 材料 | 数量 | 附件 |

| Circuits | Product name | Dimension mm | | Circuits | Product name | Dimension mm | |
|----------|--------------|--------------|-------|----------|--------------|--------------|-------|
| | | A | B | | | A | B |
| 2X2 | PHD-4AB | 2.00 | 9.10 | 2X11 | PHD-22AB | 20.00 | 27.10 |
| 2X3 | PHD-6AB | 4.00 | 11.10 | 2X12 | PHD-24AB | 22.00 | 29.10 |
| 2X4 | PHD-8AB | 6.00 | 13.10 | 2X13 | PHD-26AB | 24.00 | 31.10 |
| 2X5 | PHD-10AB | 8.00 | 15.10 | 2X14 | PHD-28AB | 26.00 | 33.10 |
| 2X6 | PHD-12AB | 10.00 | 17.10 | 2X15 | PHD-30AB | 28.00 | 35.10 |
| 2X7 | PHD-14AB | 12.00 | 19.10 | 2X16 | PHD-32AB | 30.00 | 37.10 |
| 2X8 | PHD-16AB | 14.00 | 21.10 | 2X17 | PHD-34AB | 32.00 | 39.10 |
| 2X9 | PHD-18AB | 16.00 | 23.10 | - | - | - | - |
| 2X10 | PHD-20AB | 18.00 | 25.10 | 2X30 | PHD-60AB | 58.00 | 65.10 |

| | | | |
|---------------------------------------|--------------|------------------------------------|--|
| GENERAL TOLERANCES (UNLESS SPECIFIED) | | ZHE JIANG DELI CONNECTORS CO., LTD | |
| .X: ± 0.25 | X°: ± 3.0° | PRODUCT NAME: | TITLE: 2.00 mm Pitch Wire To Board Wafer |
| .XX: ± 0.15 | .X°: ± 2.0° | DL20004 (PHD)-AB | PART NO: |
| .XXX: ± 0.01 | .XX°: ± 1.0° | DR: Chen Quan Long | DATE:21/08/01 |
| FINISH: | | CHKD:Wu Hui | DATE:21/08/01 |
| DRAWING NO: | | APPD:Ren An De | DATE:21/08/01 |
| | | SCALE: N/A | PAGE: 1/1 |
| | | UNITS: mm | REV.: A |

| REV. | REVISION DESCRIPTION | DATE | APPD |
|------|----------------------|------|------|
| | | | |

NOTES

Available in 04 through 60 Circuits.
 Mates with DL20004-Y Series Housing.
 Material : LCP UL94V-0.
 Pin Material : Brass.Tin-plated .



| | | | | | |
|----|----|-----|-----|----|---------|
| 3 | ③ | 基座 | LCP | 1 | UL94V-0 |
| 2 | ② | 焊片 | 黄铜 | 2 | 镀锡 |
| 1 | ① | 接触件 | 黄铜 | N | 镀锡 |
| 序号 | 图号 | 名称 | 材料 | 数量 | 附件 |



| Circuits | Product name | Dimension mm | | Circuits | Product name | Dimension mm | |
|----------|--------------|--------------|-------|----------|--------------|--------------|-------|
| | | A | B | | | A | B |
| 2X2 | PHD-4AWB | 2.00 | 9.10 | 2X11 | PHD-22AWB | 20.00 | 27.10 |
| 2X3 | PHD-6AWB | 4.00 | 11.10 | 2X12 | PHD-24AWB | 22.00 | 29.10 |
| 2X4 | PHD-8AWB | 6.00 | 13.10 | 2X13 | PHD-26AWB | 24.00 | 31.10 |
| 2X5 | PHD-10AWB | 8.00 | 15.10 | 2X14 | PHD-28AWB | 26.00 | 33.10 |
| 2X6 | PHD-12AWB | 10.00 | 17.10 | 2X15 | PHD-30AWB | 28.00 | 35.10 |
| 2X7 | PHD-14AWB | 12.00 | 19.10 | 2X16 | PHD-32AWB | 30.00 | 37.10 |
| 2X8 | PHD-16AWB | 14.00 | 21.10 | 2X17 | PHD-34AWB | 32.00 | 39.10 |
| 2X9 | PHD-18AWB | 16.00 | 23.10 | - | - | - | - |
| 2X10 | PHD-20AWB | 18.00 | 25.10 | 2X30 | PHD-60AWB | 58.00 | 65.10 |

| | | | | | |
|---------------------------------------|--------------|------------------------------------|--|---|--|
| GENERAL TOLERANCES (UNLESS SPECIFIED) | | ZHE JIANG DELI CONNECTORS CO., LTD | | | |
| .X: ± 0.25 | X°: ± 3.0° | PRODUCT NAME: DL20004 (PHD)-AWB | | TITLE: 2.00 mm Pitch Wire To Board Wafer | |
| .XX: ± 0.15 | .X°: ± 2.0° | DR: Chen Quan Long | | DATE:21/08/01 | |
| .XXX: ± 0.01 | .XX°: ± 1.0° | CHKD:Wu Hui | | DATE:21/08/01 | |
| FINISH: | | APPD:Ren An De | | DATE:21/08/01 | |
| DRAWING NO: | | SCALE: N/A | | PAGE: 1/1 | |
| | | UNITS: mm | | REV.: A | |

| | | | |
|------|----------------------|------|------|
| REV. | REVISION DESCRIPTION | DATE | APPD |
| | | | |

NOTES

Available in 04 through 60 Circuits.
Mates with DL20004-Y Series Housing.
Material : Nylon UL94V-0(2).
0.50mm Square Pin.
Pin Material : Brass / Tin-Plated.



PCB LAYOUT

| Circuits | Product name | Dimension mm | | | Circuits | Product name | Dimension mm | | | Circuits | Product name | Dimension mm | | |
|----------|--------------|--------------|-------|-------|----------|--------------|--------------|-------|-------|----------|--------------|--------------|-------|-------|
| | | A | B | C | | | A | B | C | | | A | B | C |
| 2X2 | PHD-4A | 2.00 | 6.00 | 5.00 | 2X10 | PHD-20A | 18.00 | 22.00 | 21.00 | 2X18 | PHD-36A | 34.00 | 38.00 | 37.00 |
| 2X3 | PHD-6A | 4.00 | 8.00 | 7.00 | 2X11 | PHD-22A | 20.00 | 24.00 | 23.00 | 2X19 | PHD-38A | 36.00 | 40.00 | 39.00 |
| 2X4 | PHD-8A | 6.00 | 10.00 | 9.00 | 2X12 | PHD-24A | 22.00 | 26.00 | 25.00 | 2X20 | PHD-40A | 38.00 | 42.00 | 41.00 |
| 2X5 | PHD-10A | 8.00 | 12.00 | 11.00 | 2X13 | PHD-26A | 24.00 | 28.00 | 27.00 | 2X21 | PHD-42A | 40.00 | 44.00 | 43.00 |
| 2X6 | PHD-12A | 10.00 | 14.00 | 13.00 | 2X14 | PHD-28A | 26.00 | 30.00 | 29.00 | 2X22 | PHD-44A | 42.00 | 46.00 | 45.00 |
| 2X7 | PHD-14A | 12.00 | 16.00 | 15.00 | 2X15 | PHD-30A | 28.00 | 32.00 | 31.00 | ~ | ~ | ~ | ~ | ~ |
| 2X8 | PHD-16A | 14.00 | 18.00 | 17.00 | 2X16 | PHD-32A | 30.00 | 34.00 | 33.00 | 2X30 | PHD-60A | 58.00 | 62.00 | 61.00 |
| 2X9 | PHD-18A | 16.00 | 20.00 | 19.00 | 2X17 | PHD-34A | 32.00 | 36.00 | 35.00 | | | | | |

| | | | |
|---------------------------------------|--------------|------------------------------------|---|
| GENERAL TOLERANCES (UNLESS SPECIFIED) | | ZHE JIANG DELI CONNECTORS CO., LTD | |
| .X: ± 0.25 | X°: ± 3.0° | PRODUCT NAME: DL20004 (PHD)-A | TITLE: 2.00 mm Pitch Wire To Board Wafer |
| .XX: ± 0.15 | .X°: ± 2.0° | DR: Chen Quan Long | DATE: 19/08/01 |
| .XXX: ± 0.01 | .XX°: ± 1.0° | DATE: 19/08/01 | PART NO: |
| FINISH: | | CHKD: Wu Hui | DATE: 19/08/01 |
| DRAWING NO: | | APPD: Ren An De | DATE: 19/08/01 |
| | | SCALE: N/A | PAGE: 1/1 |
| | | UNITS: mm | REV.: A |

| | | |
|------|----------------------|------|
| REV. | REVISION DESCRIPTION | DATE |
| | | |



NOTES

Available in 04 through 60 Circuits.
 Mates with DL20004-Y Series Housing.
 Material : Nylon UL94V-0(2).
 0.50mm Square Pin.
 Pin Material : Brass / Tin-Plated.



PCB LAYOUT

| Circuits | Product name | Dimension mm | | | Circuits | Product name | Dimension mm | | | Circuits | Product name | Dimension mm | | |
|----------|--------------|--------------|-------|-------|----------|--------------|--------------|-------|-------|----------|--------------|--------------|-------|-------|
| | | A | B | C | | | A | B | C | | | A | B | C |
| 2X2 | PHD-4AW | 2.00 | 6.00 | 5.00 | 2X10 | PHD-20AW | 18.00 | 22.00 | 21.00 | 2X18 | PHD-36AW | 34.00 | 38.00 | 37.00 |
| 2X3 | PHD-6AW | 4.00 | 8.00 | 7.00 | 2X11 | PHD-22AW | 20.00 | 24.00 | 23.00 | 2X19 | PHD-38AW | 36.00 | 40.00 | 39.00 |
| 2X4 | PHD-8AW | 6.00 | 10.00 | 9.00 | 2X12 | PHD-24AW | 22.00 | 26.00 | 25.00 | 2X20 | PHD-40AW | 38.00 | 42.00 | 41.00 |
| 2X5 | PHD-10AW | 8.00 | 12.00 | 11.00 | 2X13 | PHD-26AW | 24.00 | 28.00 | 27.00 | 2X21 | PHD-42AW | 40.00 | 44.00 | 43.00 |
| 2X6 | PHD-12AW | 10.00 | 14.00 | 13.00 | 2X14 | PHD-28AW | 26.00 | 30.00 | 29.00 | 2X22 | PHD-44AW | 42.00 | 46.00 | 45.00 |
| 2X7 | PHD-14AW | 12.00 | 16.00 | 15.00 | 2X15 | PHD-30AW | 28.00 | 32.00 | 31.00 | ~ | ~ | ~ | ~ | ~ |
| 2X8 | PHD-16AW | 14.00 | 18.00 | 17.00 | 2X16 | PHD-32AW | 30.00 | 34.00 | 33.00 | 2X30 | PHD-60AW | 58.00 | 62.00 | 61.00 |
| 2X9 | PHD-18AW | 16.00 | 20.00 | 19.00 | 2X17 | PHD-34AW | 32.00 | 36.00 | 35.00 | | | | | |

| | | | | | |
|--|--------------|------------------------------------|--|--|--|
| GENERAL TOLERANCES (UNLESS SPECIFIED) | | ZHE JIANG DELI CONNECTORS CO., LTD | | | |
| .X: ± 0.25 | X°: ± 3.0° | PRODUCT NAME: DL20004 (PHD)-AW | | TITLE: 2.0 mm Pitch Wire To Board Wafer | |
| .XX: ± 0.15 | .X°: ± 2.0° | DR: Chen Quan Long | | DATE: 19/08/01 | |
| .XXX: ± 0.01 | .XX°: ± 1.0° | CHKD: Wu Hui | | DATE: 19/08/01 | |
| FINISH: | | APPD: Ren An De | | DATE: 19/08/01 | |
| DRAWING NO: | | SCALE: N/A | | PAGE: 1/1 | |
| | | UNITS: mm | | REV.: A | |

| | | |
|------|----------------------|------|
| REV. | REVISION DESCRIPTION | DATE |
| | | |

NOTES

Available in 04 through 60 Circuits.
 Mates with DL20004-Y Series Housing.
 Material : Nylon UL94V-0(2).
 0.50mm Square Pin.
 Pin Material : Brass / Tin-Plated.

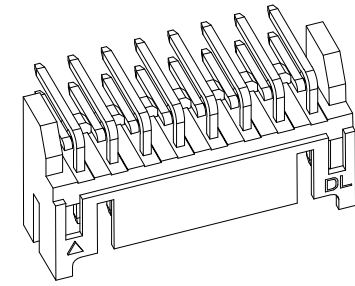
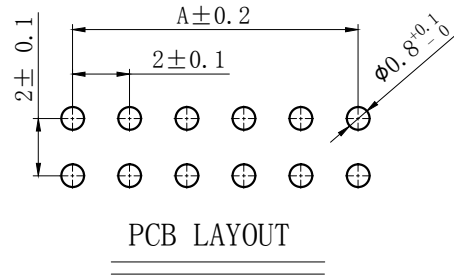
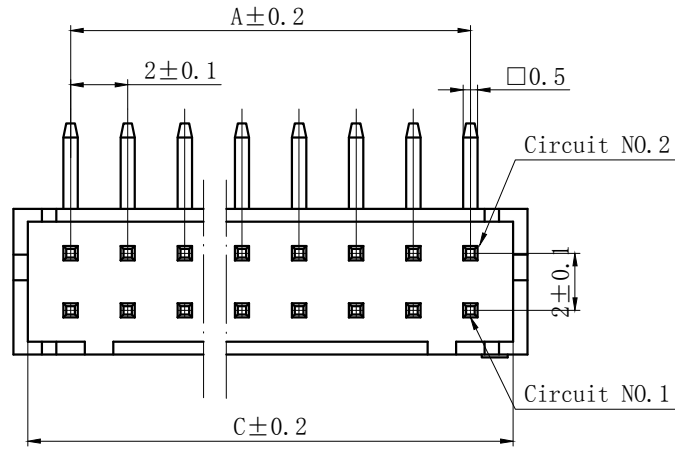
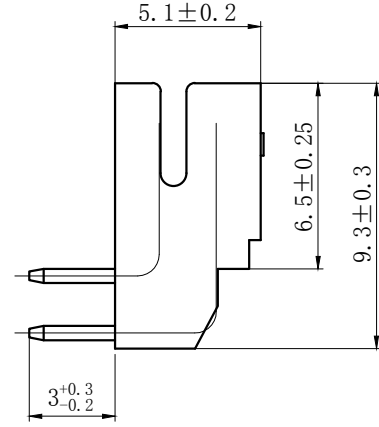

| Circuits | Product name | Dimension mm | | | Circuits | Product name | Dimension mm | | | Circuits | Product name | Dimension mm | | |
|----------|--------------|--------------|-------|-------|----------|--------------|--------------|-------|-------|----------|--------------|--------------|-------|-------|
| | | A | B | C | | | A | B | C | | | A | B | C |
| 2X2 | PHD-4AWD | 2.00 | 6.00 | 5.00 | 2X10 | PHD-20AWD | 18.00 | 22.00 | 21.00 | 2X18 | PHD-36AWD | 34.00 | 38.00 | 37.00 |
| 2X3 | PHD-6AWD | 4.00 | 8.00 | 7.00 | 2X11 | PHD-22AWD | 20.00 | 24.00 | 23.00 | 2X19 | PHD-38AWD | 36.00 | 40.00 | 39.00 |
| 2X4 | PHD-8AWD | 6.00 | 10.00 | 9.00 | 2X12 | PHD-24AWD | 22.00 | 26.00 | 25.00 | 2X20 | PHD-40AWD | 38.00 | 42.00 | 41.00 |
| 2X5 | PHD-10AWD | 8.00 | 12.00 | 11.00 | 2X13 | PHD-26AWD | 24.00 | 28.00 | 27.00 | 2X21 | PHD-42AWD | 40.00 | 44.00 | 43.00 |
| 2X6 | PHD-12AWD | 10.00 | 14.00 | 13.00 | 2X14 | PHD-28AWD | 26.00 | 30.00 | 29.00 | 2X22 | PHD-44AWD | 42.00 | 46.00 | 45.00 |
| 2X7 | PHD-14AWD | 12.00 | 16.00 | 15.00 | 2X15 | PHD-30AWD | 28.00 | 32.00 | 31.00 | ~ | ~ | ~ | ~ | ~ |
| 2X8 | PHD-16AWD | 14.00 | 18.00 | 17.00 | 2X16 | PHD-32AWD | 30.00 | 34.00 | 33.00 | 2X30 | PHD-60AWD | 58.00 | 62.00 | 61.00 |
| 2X9 | PHD-18AWD | 16.00 | 20.00 | 19.00 | 2X17 | PHD-34AWD | 32.00 | 36.00 | 35.00 | | | | | |

| | | | | | |
|--|--------------|------------------------------------|--|---|--|
| GENERAL TOLERANCES (UNLESS SPECIFIED) | | ZHE JIANG DELI CONNECTORS CO., LTD | | | |
| .X: ± 0.25 | X°: ± 3.0° | PRODUCT NAME: DL20004 (PHD)-AWD | | TITLE: 2.0 mm Pitch Wire To Board Wafer | |
| .XX: ± 0.15 | .X°: ± 2.0° | DR: Chen Quan Long | | DATE: 19/08/01 | |
| .XXX: ± 0.01 | .XX°: ± 1.0° | FINISH: | | PART NO: | |
| DRAWING NO: | | CHKD: Wu Hui | | DATE: 19/08/01 | |
| | | APPD: Ren An De | | DATE: 19/08/01 | |
| | | UNITS: mm | | PAGE: 1/1 | |
| | | REV.: A | | | |

| REV. | REVISION DESCRIPTION | DATE | APPD |
|------|----------------------|------|------|
| | | | |

NOTES

Available in 04 through 60 Circuits.
 Match with DL20004 series housing
 Material : Nylon UL94V-0(2).
 Accepts DL20004-T Crimp Terminal.

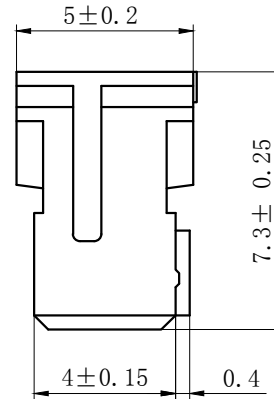
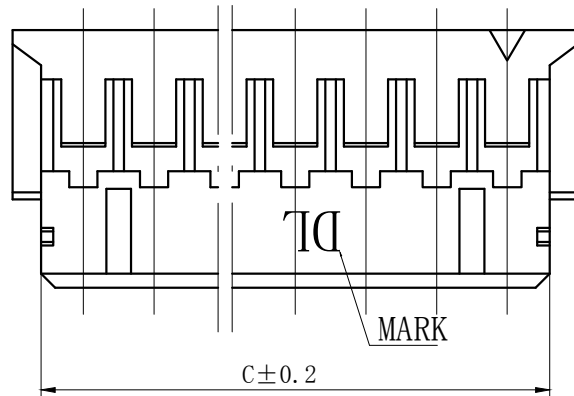
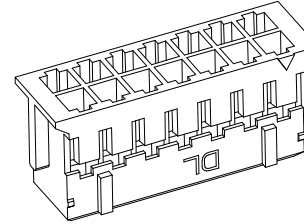
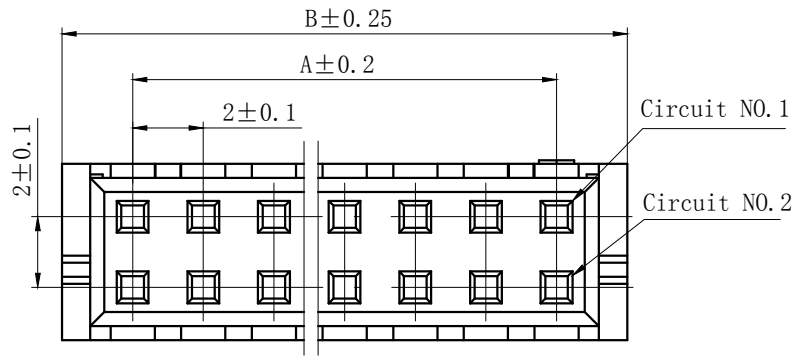

| Circuits | Product name | Dimension mm | | | Circuits | Product name | Dimension mm | | | Circuits | Product name | Dimension mm | | |
|----------|--------------|--------------|------|------|----------|--------------|--------------|------|------|----------|--------------|--------------|------|------|
| | | A | B | C | | | A | B | C | | | A | B | C |
| 2X2 | PHD-4Y | 2.0 | 6.0 | 4.6 | 2X10 | PHD-20Y | 18.0 | 22.0 | 20.6 | 2X18 | PHD-36Y | 34.0 | 38.0 | 36.6 |
| 2X3 | PHD-6Y | 4.0 | 8.0 | 6.6 | 2X11 | PHD-22Y | 20.0 | 24.0 | 22.6 | 2X19 | PHD-38Y | 36.0 | 40.0 | 38.6 |
| 2X4 | PHD-8Y | 6.0 | 10.0 | 8.6 | 2X12 | PHD-24Y | 22.0 | 26.0 | 24.6 | 2X20 | PHD-40Y | 38.0 | 42.0 | 40.6 |
| 2X5 | PHD-10Y | 8.0 | 12.0 | 10.6 | 2X13 | PHD-26Y | 24.0 | 28.0 | 26.6 | ~ | ~ | ~ | ~ | ~ |
| 2X6 | PHD-12Y | 10.0 | 14.0 | 12.6 | 2X14 | PHD-28Y | 26.0 | 30.0 | 28.6 | 2X30 | PHD-60Y | 58.0 | 62.0 | 60.6 |
| 2X7 | PHD-14Y | 12.0 | 16.0 | 14.6 | 2X15 | PHD-30Y | 28.0 | 32.0 | 30.6 | | | | | |
| 2X8 | PHD-16Y | 14.0 | 18.0 | 16.6 | 2X16 | PHD-32Y | 30.0 | 34.0 | 32.6 | | | | | |
| 2X9 | PHD-18Y | 16.0 | 20.0 | 18.6 | 2X17 | PHD-34Y | 32.0 | 36.0 | 34.6 | | | | | |

| GENERAL TOLERANCES (UNLESS SPECIFIED) | | ZHE JIANG DELI CONNECTORS CO., LTD | |
|--|-----------------------|---|--|
| .X: ± 0.25 | X°: $\pm 3.0^\circ$ | PRODUCT NAME: DL20004 (PHD)-Y | TITLE: 2.00 mm Pitch Wire To Board Housing |
| .XX: ± 0.15 | .X°: $\pm 2.0^\circ$ | DR: Chen Quhan Long | DATE: 21/08/01 |
| .XXX: ± 0.01 | .XX°: $\pm 1.0^\circ$ | CHKD: Wu Hui | DATE: 21/08/01 |
| FINISH: | | APPD: Ren An De | DATE: 21/08/01 |
| DRAWING NO: | | | |
| | | SCALE: N/A | PAGE: 1/1 |
| | | UNITS: mm | REV.: A |

| REV. | REVISION DESCRIPTION | DATE | APPD |
|------|----------------------|------|------|
| B | | | |
| C | | | |

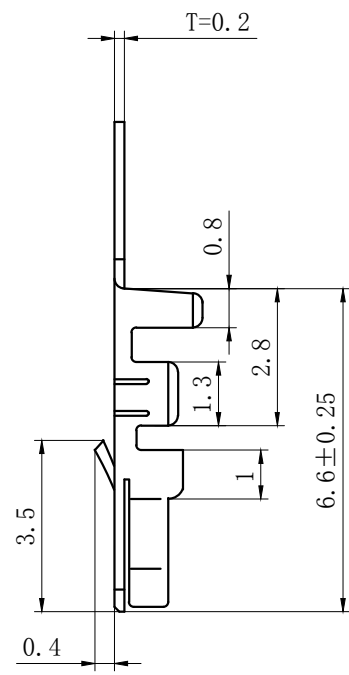

NOTES

Used in DL20004-Y or DL20016-Y or DL20017-Y Series Housing.

Accepts AWG #28~22 Wire Range.

0.08~ 0.33 mm² .
Insulation O.D.=0.9~1.5 mm.

Material : Phosphor Bronze .

Finish: Tin plated.

Thickness: 0.2 mm.

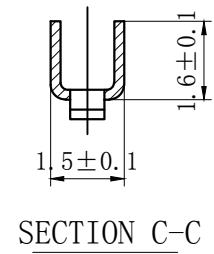
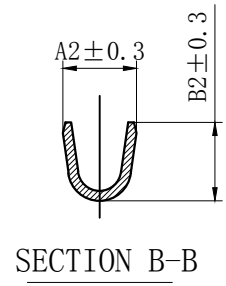
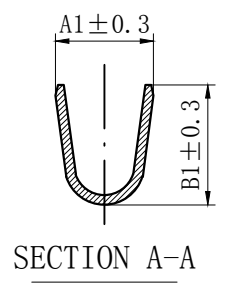

| Product name | Dimension mm | | | | 适用线规AWG |
|--------------|--------------|------|-----|------|---------|
| | A1 | B1 | A2 | B2 | |
| PHD-T-G | 2.3 | 2.45 | 1.5 | 1.6 | #26-22 |
| PHD-T-D | 1.9 | 1.6 | 1.4 | 1.15 | #28-24 |

| GENERAL TOLERANCES (UNLESS SPECIFIED) | | ZHE JIANG DELI CONNECTORS CO., LTD | | | |
|---------------------------------------|--------------|---|--------------|---|-----------|
| .X: ± 0.25 | X°: ± 3.0° | PRODUCT NAME: DL20004 (PHD)-T | | TITLE: 2.00 mm Pitch Crimp Terminal | |
| .XX: ± 0.2 | .X°: ± 2.0° | DR:Chen QuanLong | | DATE:21.3.31 | |
| .XXX: ± 0.01 | .XX°: ± 1.0° | DATE:21.3.31 | | PART NO: | |
| FINISH: | | CHKD:Wu Hui | DATE:21.3.31 | SCALE: N/A | PAGE: 1/1 |
| DRAWING NO: | | APPD:Ren An De | DATE:21.3.31 | UNITS: mm | REV.: A |

X-ON Electronics

Largest Supplier of Electrical and Electronic Components

Click to view similar products for [Headers & Wire Housings](#) category:

Click to view products by [DLL](#) manufacturer:

Other Similar products are found below :

[0015917161](#) [0022155065](#) [57102-F02-18ULF](#) [58102-G61-06LF](#) [582553-1](#) [01.001.5753.1](#) [0050291907](#) [02.125.8002.8](#) [609-3404](#) [61062-3](#)
[CSU011177004](#) [622-0430](#) [622-3653LF](#) [63453-116](#) [636-1030](#) [636-1427](#) [636-3427](#) [636-4007](#) [641938-9](#) [65495-038](#) [65692-001LF](#) [65781-018](#)
[65781-047](#) [65817-010LF](#) [65817-015LF](#) [67095-007LF](#) [67601157](#) [68631-112](#) [68645-018](#) [699319-000](#) [70.362.1628.0](#) [70-4210](#) [70-4226B](#) [70-](#)
[4853B](#) [71.350.2428.0](#) [733-134](#) [733-162](#) [MHR-64-VUAL](#) [80.063.4001.1](#) [800-90-001-10-001000](#) [801-43-002-10-013000](#) [801-43-006-10-](#)
[002000](#) [803-43-024-10-001000](#) [803-93-012-10-001000](#) [8-1437020-4](#) [819-22-004-30-001101](#) [820-22-006-30-001101](#) [820-22-008-30-001101](#)
[821-22-002-10-001101](#) [821-22-003-10-002101](#)