

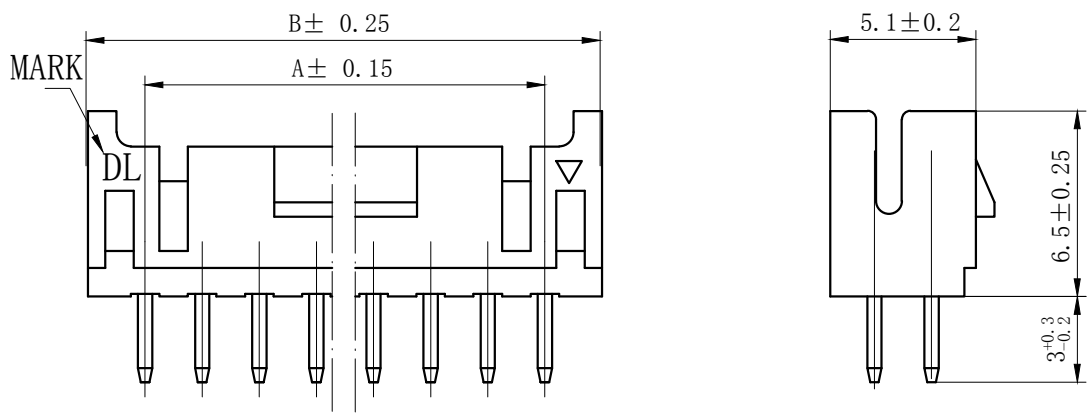

**技术特性/Specifications:**

额定电压 Rated voltage: 250V AC, DC  
额定电流 Rated current: 3A AC, DC  
接触电阻 Contact resistance: 20m $\Omega$  max  
绝缘电阻 Insulation resistance: 1000M $\Omega$  min  
耐压 Withstand voltage: 800V AC/minute  
环境温度 Ambient temperature: -40 $^{\circ}$ C~+105 $^{\circ}$ C  
适用线规 Wire range: AWG#28~#22

REV.	REVISION DESCRIPTION	DATE



### NOTES

Available in 04 through 60 Circuits.  
 Mates with DL20017-Y Series Housing.  
 Material : Nylon UL94V-0(2).  
 0.50mm Square Pin.  
 Pin Material : Brass / Tin-Plated.



PCB LAYOUT

Circuits	Product name	Dimension mm			Circuits	Product name	Dimension mm			Circuits	Product name	Dimension mm		
		A	B	C			A	B	C			A	B	C
2X2	PHDS-4A	2.00	6.00	5.00	2X10	PHDS-20A	18.00	22.00	21.00	2X18	PHDS-36A	34.00	38.00	37.00
2X3	PHDS-6A	4.00	8.00	7.00	2X11	PHDS-22A	20.00	24.00	23.00	2X19	PHDS-38A	36.00	40.00	39.00
2X4	PHDS-8A	6.00	10.00	9.00	2X12	PHDS-24A	22.00	26.00	25.00	2X20	PHDS-40A	38.00	42.00	41.00
2X5	PHDS-10A	8.00	12.00	11.00	2X13	PHDS-26A	24.00	28.00	27.00	~	~	~	~	~
2X6	PHDS-12A	10.00	14.00	13.00	2X14	PHDS-28A	26.00	30.00	29.00	2X30	PHDS-60A	58.00	62.00	61.00
2X7	PHDS-14A	12.00	16.00	15.00	2X15	PHDS-30A	28.00	32.00	31.00					
2X8	PHDS-16A	14.00	18.00	17.00	2X16	PHDS-32A	30.00	34.00	33.00					
2X9	PHDS-18A	16.00	20.00	19.00	2X17	PHDS-34A	32.00	36.00	35.00					

GENERAL TOLERANCES (UNLESS SPECIFIED)		ZHE JIANG DELI CONNECTORS CO., LTD		
.X: ± 0.25	X°: ± 3.0°	PRODUCT NAME: <b>DL20017(PHDS)-A</b>	TITLE: 2.0 mm Pitch Wire To Board Wafer	
.XX: ± 0.15	.X°: ± 2.0°	DR: Yuan JunRong	DATE:21/08/01	
.XXX: ± 0.01	.XX°: ± 1.0°	CHKD: Wu Hui	DATE:21/08/01	
DRAWING NO:		APPD:Ren An De	DATE:21/08/01	
			PART NO:	
			SCALE: N/A	PAGE: 1/1
			UNITS: mm	REV.: A

REV.	REVISION	DATE
	DESCRIPTION	



### NOTES

Available in 04 through 60 Circuits.  
 Mates with DL20017-Y Series Housing.  
 Material : Nylon UL94V-0(2).  
 0.50mm Square Pin.  
 Pin Material : Brass / Tin-Plated.

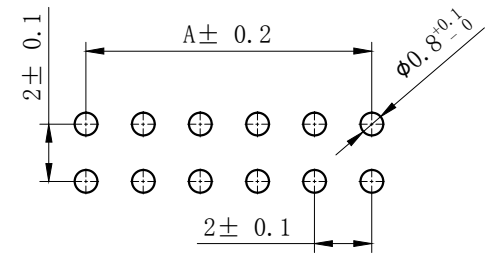
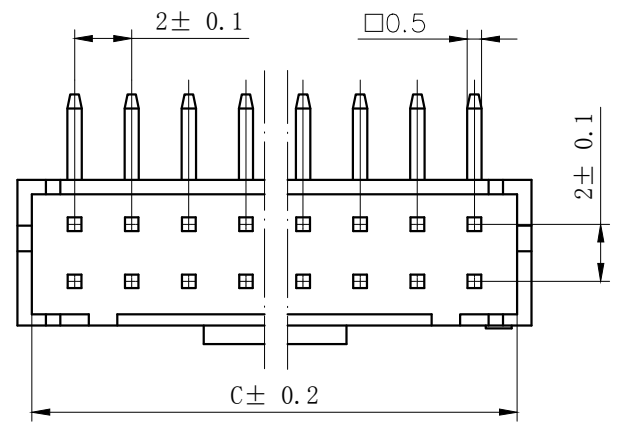

PCB LAYOUT

Circuits	Product name	Dimension mm			Circuits	Product name	Dimension mm			Circuits	Product name	Dimension mm		
		A	B	C			A	B	C			A	B	C
2X2	PHDS-4AW	2.00	6.00	5.00	2X10	PHDS-20AW	18.00	22.00	21.00	2X18	PHDS-36AW	34.00	38.00	37.00
2X3	PHDS-6AW	4.00	8.00	7.00	2X11	PHDS-22AW	20.00	24.00	23.00	2X19	PHDS-38AW	36.00	40.00	39.00
2X4	PHDS-8AW	6.00	10.00	9.00	2X12	PHDS-24AW	22.00	26.00	25.00	2X20	PHDS-40AW	38.00	42.00	41.00
2X5	PHDS-10AW	8.00	12.00	11.00	2X13	PHDS-26AW	24.00	28.00	27.00	~	~	~	~	~
2X6	PHDS-12AW	10.00	14.00	13.00	2X14	PHDS-28AW	26.00	30.00	29.00	2X30	PHDS-60AW	58.00	62.00	61.00
2X7	PHDS-14AW	12.00	16.00	15.00	2X15	PHDS-30AW	28.00	32.00	31.00					
2X8	PHDS-16AW	14.00	18.00	17.00	2X16	PHDS-32AW	30.00	34.00	33.00					
2X9	PHDS-18AW	16.00	20.00	19.00	2X17	PHDS-34AW	32.00	36.00	35.00					

GENERAL TOLERANCES (UNLESS SPECIFIED)		ZHE JIANG DELI CONNECTORS CO., LTD	
.X: ± 0.25	X°: ± 3.0°	PRODUCT NAME: <b>DL20017 (PHDS)-AW</b>	TITLE: 2.0 mm Pitch Wire To Board Wafer
.XX: ± 0.15	.X°: ± 2.0°	DR: Yuan Junrong	DATE:21/08/01
.XXX: ± 0.01	.XX°: ± 1.0°	CHKD: Wu Hui	DATE:21/08/01
FINISH:		APPD: Ren An De	DATE:21/08/01
DRAWING NO:			
		SCALE: N/A	PAGE: 1/1
		UNITS: mm	REV.: A

REV.	REVISION DESCRIPTION	DATE	APPD
A1	更新公差	19.8.1	Wu



### NOTES

Available in 04 through 60 Circuits.  
Mates with DL20017-Y Series Housing.  
Material : Nylon UL94V-0(2).  
0.50mm Square Pin.  
Pin Material : Brass / Tin-Plated.



Circuits	Product name	Dimension mm			Circuits	Product name	Dimension mm			Circuits	Product name	Dimension mm		
		A	B	C			A	B	C			A	B	C
2X2	PHDS-4AWD	2.00	6.00	5.00	2X10	PHDS-20AWD	18.00	22.00	21.00	2X18	PHDS-36AWD	34.00	38.00	37.00
2X3	PHDS-6AWD	4.00	8.00	7.00	2X11	PHDS-22AWD	20.00	24.00	23.00	2X19	PHDS-38AWD	36.00	40.00	39.00
2X4	PHDS-8AWD	6.00	10.00	9.00	2X12	PHDS-24AWD	22.00	26.00	25.00	2X20	PHDS-40AWD	38.00	42.00	41.00
2X5	PHDS-10AWD	8.00	12.00	11.00	2X13	PHDS-26AWD	24.00	28.00	27.00	~	~	~	~	
2X6	PHDS-12AWD	10.00	14.00	13.00	2X14	PHDS-28AWD	26.00	30.00	29.00	2X30	PHDS-60AWD	58.00	62.00	61.00
2X7	PHDS-14AWD	12.00	16.00	15.00	2X15	PHDS-30AWD	28.00	32.00	31.00					
2X8	PHDS-16AWD	14.00	18.00	17.00	2X16	PHDS-32AWD	30.00	34.00	33.00					
2X9	PHDS-18AWD	16.00	20.00	19.00	2X17	PHDS-34AWD	32.00	36.00	35.00					

GENERAL TOLERANCES (UNLESS SPECIFIED)		ZHE JIANG DELI CONNECTORS CO., LTD	
.X: ± 0.25	X°: ± 3.0°	PRODUCT NAME: DL20017 (PHDS)-AWD	TITLE: 2.0 mm Pitch Wire To Board Wafer
.XX: ± 0.15	.X°: ± 2.0°	DR: Yuan Junrong	DATE: 21/08/01
.XXX: ± 0.01	.XX°: ± 1.0°	CHKD: Hu Hui	DATE: 21/08/01
FINISH:		APPD: Ren An De	DATE: 21/08/01
DRAWING NO:			
		PART NO:	SCALE: N/A
			PAGE: 1/1
		UNITS: mm	REV.: A1

REV.	REVISION DESCRIPTION	DATE	APPD

### NOTES

Available in 04 through 60 Circuits.  
 Mates with DL20017-A or DL20017-AW or DL20017-AWD Series WAFER.  
 Material : Nylon UL94V-0(2).  
 Accepts DL20004-T Crimp Terminal.

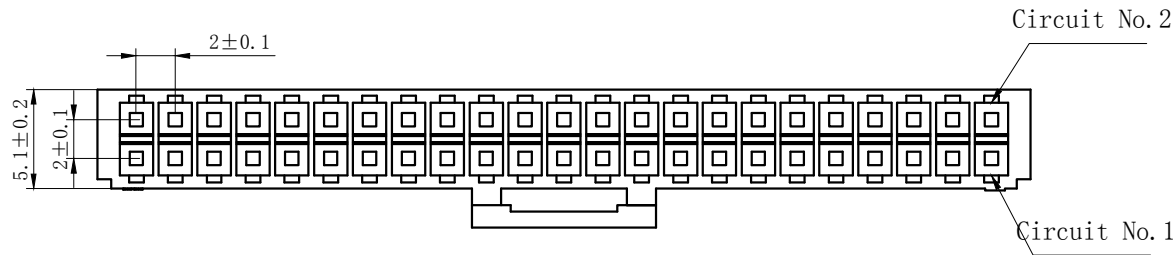
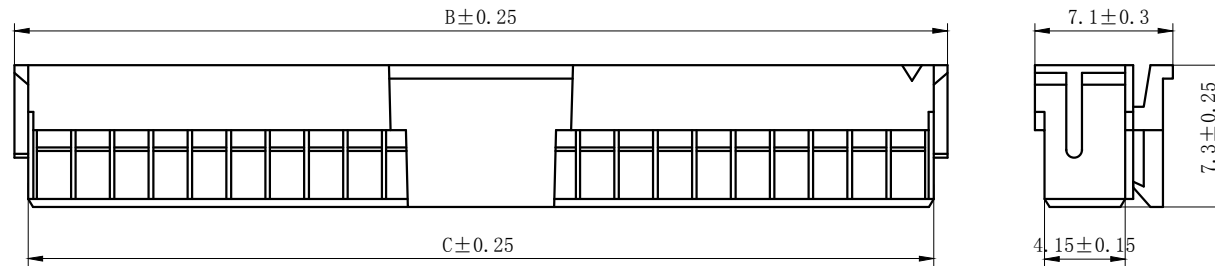

Circuits	Product name	Dimension mm			Circuits	Product name	Dimension mm			Circuits	Product name	Dimension mm		
		A	B	C			A	B	C			A	B	C
2X2	PHDS-4Y	2.00	6.00	4.60	2X10	PHDS-20Y	18.00	22.00	20.60	2X18	PHDS-36Y	34.00	38.00	36.60
2X3	PHDS-6Y	4.00	8.00	6.60	2X11	PHDS-22Y	20.00	24.00	22.60	2X19	PHDS-38Y	36.00	40.00	38.60
2X4	PHDS-8Y	6.00	10.00	8.60	2X12	PHDS-24Y	22.00	26.00	24.60	2X20	PHDS-40Y	38.00	42.00	40.60
2X5	PHDS-10Y	8.00	12.00	10.60	2X13	PHDS-26Y	24.00	28.00	26.60	2X21	PHDS-42Y	40.00	44.00	42.60
2X6	PHDS-12Y	10.00	14.00	12.60	2X14	PHDS-28Y	26.00	30.00	28.60	2X22	PHDS-44Y	42.00	46.00	44.60
2X7	PHDS-14Y	12.00	16.00	14.60	2X15	PHDS-30Y	28.00	32.00	30.60	~	~	~	~	~
2X8	PHDS-16Y	14.00	18.00	16.60	2X16	PHDS-32Y	30.00	34.00	32.60	2X30	PHDS-60Y	58.00	62.00	60.60
2X9	PHDS-18Y	16.00	20.00	18.60	2X17	PHDS-34Y	32.00	36.00	34.60					

GENERAL TOLERANCES (UNLESS SPECIFIED)		ZHE JIANG DELI CONNECTORS CO., LTD	
.X: ± 0.25	X° : ± 3.0°	PRODUCT NAME: <b>DL20017 (PHDS)-Y</b>	
.XX: ± 0.15	.X° : ± 2.0°	TITLE: 2.0 mm Pitch Wire To Board Wafer	
.XXX: ± 0.01	.XX° : ± 1.0°	DR: Yuan Junrong	DATE:21/08/01
FINISH:		CHKD: Wu Hui	DATE:21/08/01
DRAWING NO:		APPD:Ren An De	DATE:21/08/01
		SCALE: N/A	PAGE: 1/1
		UNITS: mm	REV. : A

REV.	REVISION DESCRIPTION	DATE	APPD
B			
C			

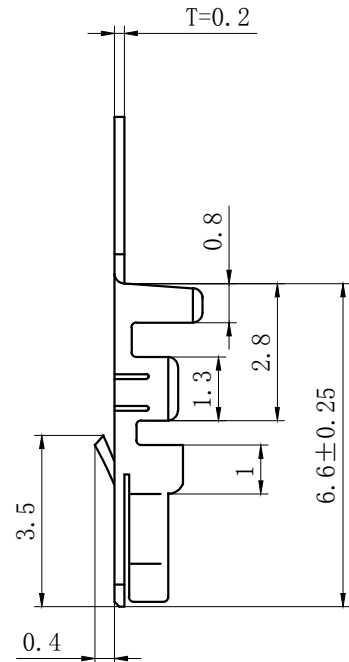

### NOTES

Used in DL20004-Y or DL20016-Y or DL20017-Y Series Housing.

Accepts AWG #28~22 Wire Range.

0.08~ 0.33 mm<sup>2</sup> .

Insulation O.D.=0.9~1.5 mm.

Material : Phosphor Bronze .

Finish: Tin plated.

Thickness: 0.2 mm.

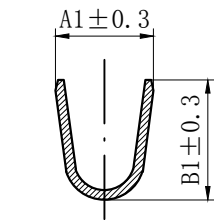

SECTION A-A

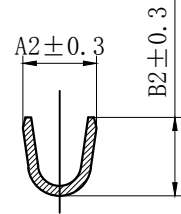

SECTION B-B

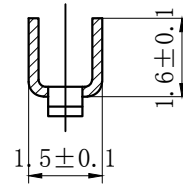

SECTION C-C

Product name	Dimension mm				适用线规AWG
	A1	B1	A2	B2	
PHD-T-G	2.3	2.45	1.5	1.6	#26-22
PHD-T-D	1.9	1.6	1.4	1.15	#28-24

GENERAL TOLERANCES (UNLESS SPECIFIED)		ZHE JIANG DELI CONNECTORS CO., LTD			
.X: ± 0.25	X°: ± 3.0°	PRODUCT NAME: <b>DL20004 (PHD)-T</b>		TITLE: 2.00 mm Pitch Crimp Terminal	
.XX: ± 0.2	.X°: ± 2.0°	DR:Chen QuanLong		DATE:21.3.31	
.XXX: ± 0.01	.XX°: ± 1.0°	DATE:21.3.31		PART NO:	
FINISH:		CHKD:Wu Hui	DATE:21.3.31	SCALE: N/A	PAGE: 1/1
DRAWING NO:		APPD:Ren An De	DATE:21.3.31	UNITS: mm	REV.: A

## X-ON Electronics

Largest Supplier of Electrical and Electronic Components

*Click to view similar products for [Headers & Wire Housings](#) category:*

*Click to view products by [DLL](#) manufacturer:*

Other Similar products are found below :

[0015917161](#) [0022155065](#) [57102-F02-18ULF](#) [58102-G61-06LF](#) [582553-1](#) [01.001.5753.1](#) [0050291907](#) [02.125.8002.8](#) [609-3404](#) [61062-3](#)  
[CSU011177004](#) [622-0430](#) [622-3653LF](#) [63453-116](#) [636-1030](#) [636-1427](#) [636-3427](#) [636-4007](#) [641938-9](#) [65495-038](#) [65692-001LF](#) [65781-018](#)  
[65781-047](#) [65817-010LF](#) [65817-015LF](#) [67095-007LF](#) [67601157](#) [68631-112](#) [68645-018](#) [699319-000](#) [70.362.1628.0](#) [70-4210](#) [70-4226B](#) [70-](#)  
[4853B](#) [71.350.2428.0](#) [733-134](#) [733-162](#) [MHR-64-VUAL](#) [80.063.4001.1](#) [800-90-001-10-001000](#) [801-43-002-10-013000](#) [801-43-006-10-](#)  
[002000](#) [803-43-024-10-001000](#) [803-93-012-10-001000](#) [8-1437020-4](#) [819-22-004-30-001101](#) [820-22-006-30-001101](#) [820-22-008-30-001101](#)  
[821-22-002-10-001101](#) [821-22-003-10-002101](#)