

技术特性/Specifications:

额定电压 Rated voltage: 12V AC, DC
额定电流 Rated current: 3mA AC, DC
接触电阻 Contact resistance: 20m Ω max
绝缘电阻 Insulation resistance: 100M Ω min
耐压 Withstand voltage: 1000V AC/minute
环境温度 Ambient temperature: -40 $^{\circ}$ C~+105 $^{\circ}$ C
适用线规 Wire range: AWG#24~#20

REV.	REVISION DESCRIPTION	DATE	APPD

NOTES

Available in 08 through 40 Circuits.

Match with DL22001-Y series housing.

Material : PBT UL94-V0.

Pin Material : Brass .

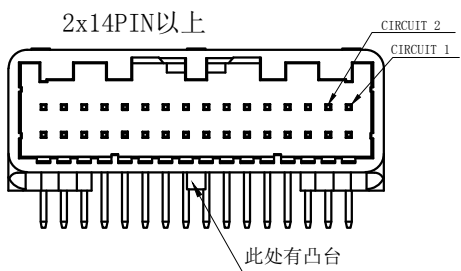
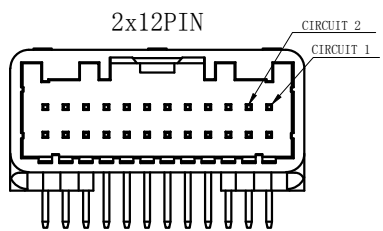
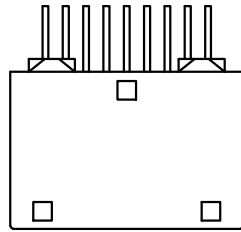
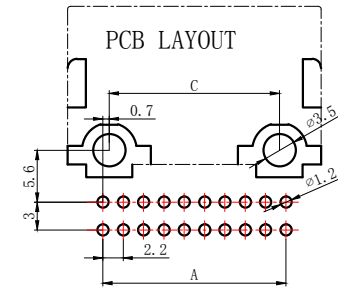
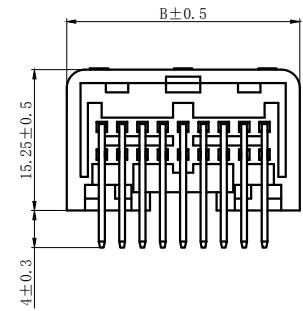
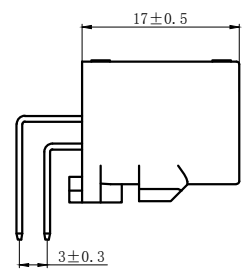
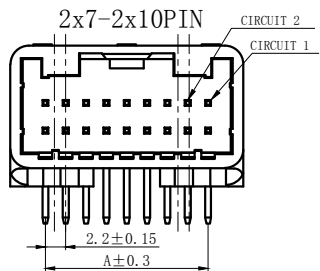
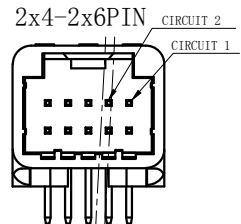
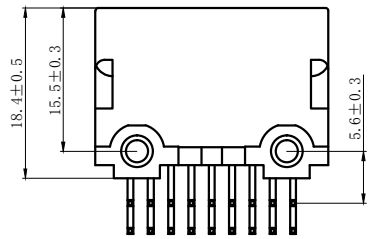

Circuits	Product name	Dimensino (mm)			Circuits	Product name	Dimensino (mm)		
		A	B	C			A	B	C
2X4	QA-8AW	6.60	14.20	8.20	2X10	QA-20AW	19.80	27.40	21.50
2X5	QA-10AW	8.80	16.40	9.50	2X12	QA-24AW	24.20	31.80	23.10
2X6	QA-12AW	11.00	18.60	9.60	2X14	QA-28AW	28.60	36.20	27.20
2X7	QA-14AW	13.20	20.80	11.80	2X16	QA-32AW	33.00	40.60	31.60
2X8	QA-16AW	15.40	23.00	14.00	2X20	QA-40AW	41.80	49.40	40.40
2X9	QA-18AW	17.60	25.20	16.20					

GENERAL TOLERANCES (UNLESS SPECIFIED)		ZHE JIANG DELI CONNECTORS CO., LTD	
.X: ± 0.25	X°: ± 3.0°	PRODUCT NAME: DL22001 (QA)-AW	TITLE: 2.20 mm Pitch Housing
.XX: ± 0.15	.X°: ± 2.0°	DR: Chen Quan Long	DATE: 22/08/01
.XXX: ± 0.01	.XX°: ± 1.0°	CHKD: Wu Hui	DATE: 22/08/01
FINISH:		APPD: Ren An De	DATE: 22/08/01
DRAWING NO:			
		SCALE: N/A	PAGE: 1/1
		UNITS: mm	REV.: A

REV.	REVISION DESCRIPTION	DATE	APPD

NOTES

Available in 08 through 40 Circuits.
 Match with DL22001 series housing.
 Material : PBT UL94-V0.
 Accepts DL22001-T Crimp Terminal.

2	②	护圈	PBT	1
1	①	底座	PBT	1
序号	图号	名称	材料	数量

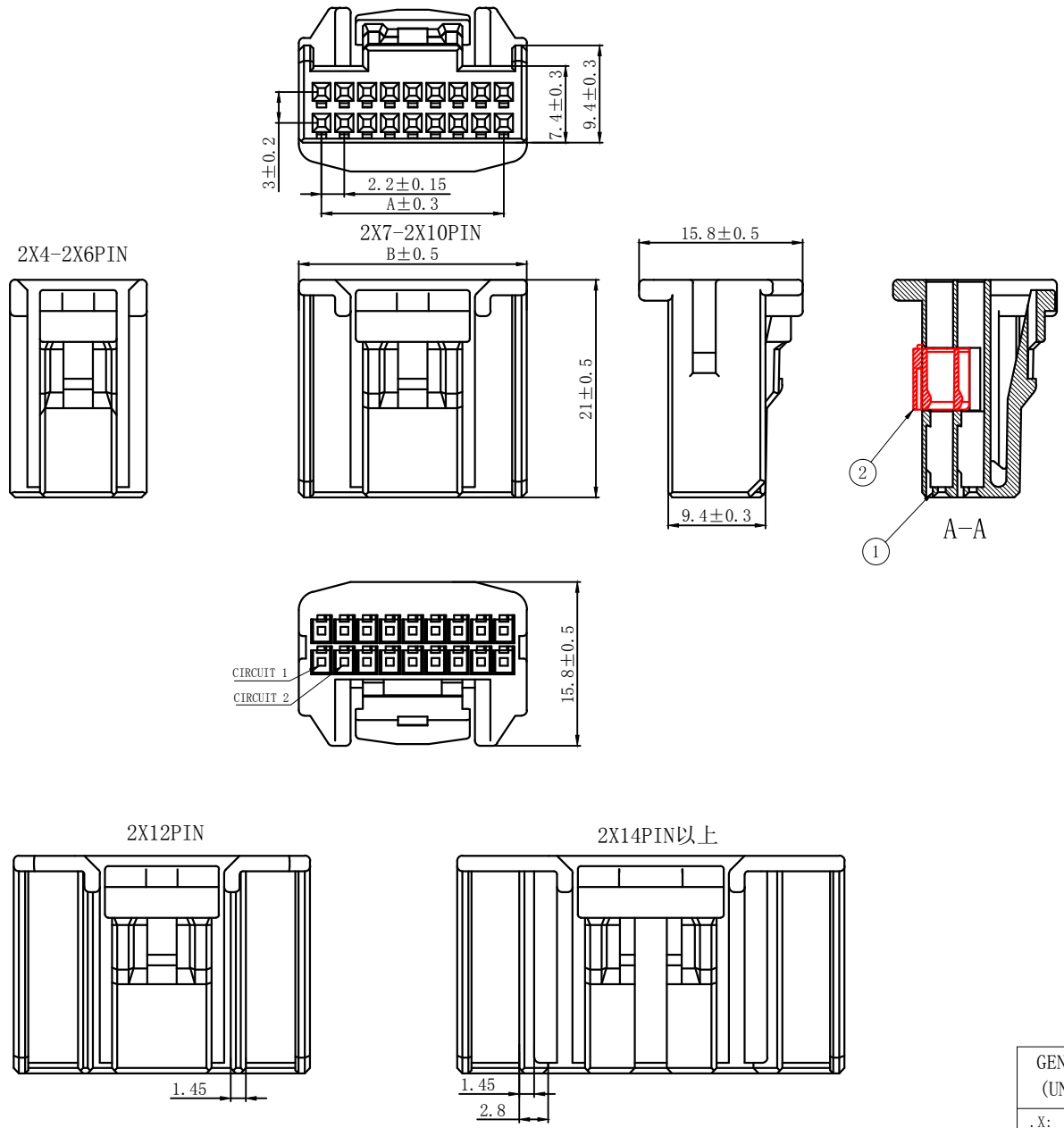

Circuits	product name	Dimensino (mm)		Circuits	product name	Dimensino (mm)	
		A	B			A	B
2X4	QA-8Y	6.60	11.00	2X10	QA-20Y	19.80	24.20
2X5	QA-10Y	8.80	13.20	2X12	QA-24Y	24.20	28.60
2X6	QA-12Y	11.00	15.40	2X14	QA-28Y	28.60	33.00
2X7	QA-14Y	13.20	17.60	2X16	QA-32Y	33.00	37.40
2X8	QA-16Y	15.40	19.80	2X20	QA-40Y	41.80	46.20
2X9	QA-18Y	17.60	22.00				

GENERAL TOLERANCES (UNLESS SPECIFIED)		ZHE JIANG DELI CONNECTORS CO., LTD	
.X: ± 0.25	X°: ± 3.0°	PRODUCT NAME: DL22001 (QA)-Y	TITLE: 2.00 mm Pitch Housing
.XX: ± 0.15	.X°: ± 2.0°	DR: Chen Quan Long	DATE: 23/09/01
.XXX: ± 0.01	.XX°: ± 1.0°	CHKD: Wu Hui	DATE: 23/09/01
FINISH:		APPD: Ren An De	DATE: 23/09/01
DRAWING NO:			
		SCALE: N/A	PAGE: 1/1
		UNITS: mm	REV.: A

REV.	REVISION DESCRIPTION	DATE	APPD

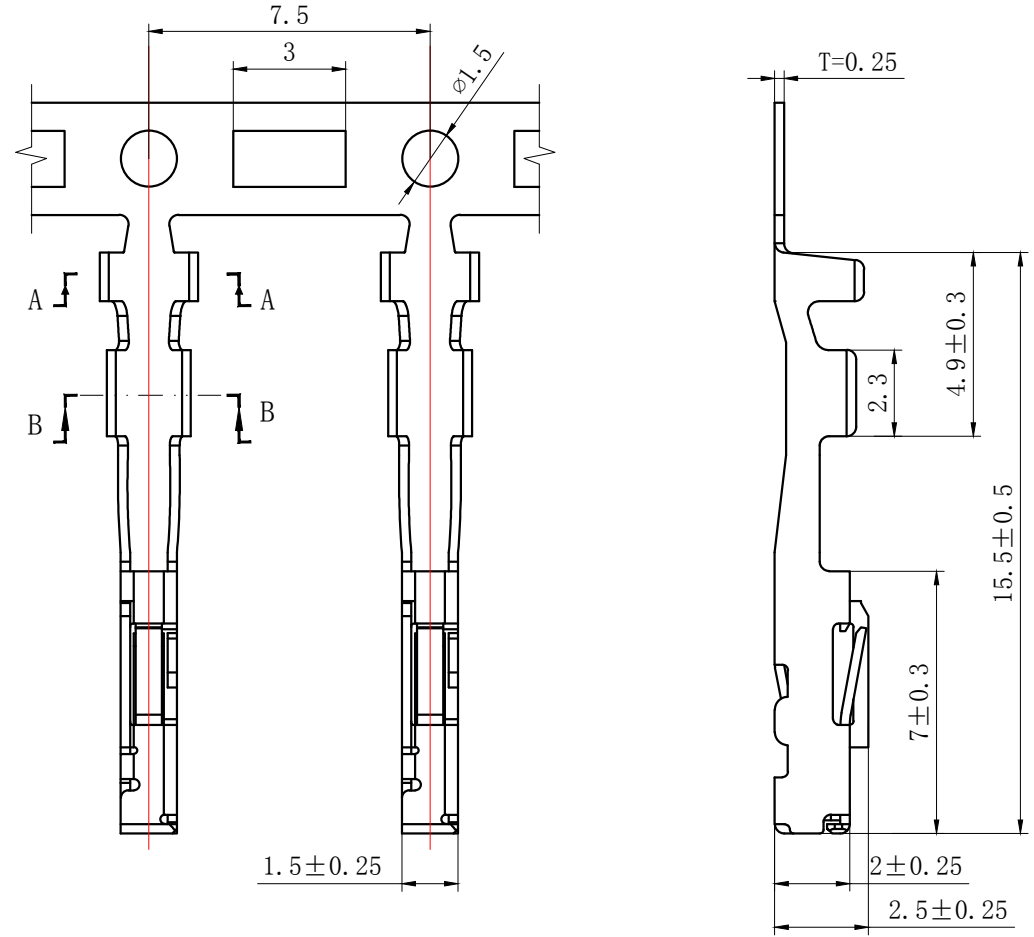

1.5 ± 0.25

$T=0.25$

2 ± 0.25
 2.5 ± 0.25
 7 ± 0.3
 4.9 ± 0.3
 15.5 ± 0.5

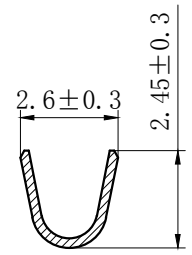

SECTION A-A

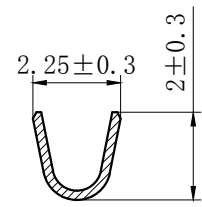

SECTION B-B

NOTES

- Used in DL22001-Y Series Housing.
- Accepts AWG #20~24 Wire Range.
- Material : Phosphor Bronze .
- Finish: Tin plated.
- Thickness: 0.25 mm.

GENERAL TOLERANCES (UNLESS SPECIFIED)		ZHE JIANG DELI CONNECTORS CO., LTD	
.X: ± 0.25	X° : $\pm 3.0^\circ$	PRODUCT NAME: DL22001 (QA)-T	TITLE: 2.20 mm Pitch Crimp Terminal
.XX: ± 0.15	.X° : $\pm 2.0^\circ$	DR: Chen Quan Long	DATE: 22/08/01
.XXX: ± 0.01	.XX° : $\pm 1.0^\circ$	CHKD: Wu Hui	DATE: 22/08/01
DRAWING NO:		APPD: Ren An De	DATE: 22/08/01
		SCALE: N/A	PAGE: 1/1
		UNITS: mm	REV.: A

X-ON Electronics

Largest Supplier of Electrical and Electronic Components

Click to view similar products for [Headers & Wire Housings](#) category:

Click to view products by [DLL](#) manufacturer:

Other Similar products are found below :

[0015917161](#) [0022155065](#) [57102-F02-18ULF](#) [58102-G61-06LF](#) [582553-1](#) [01.001.5753.1](#) [0050291907](#) [02.125.8002.8](#) [609-3404](#) [61062-3](#)
[CSU011177004](#) [622-0430](#) [622-3653LF](#) [63453-116](#) [636-1030](#) [636-1427](#) [636-3427](#) [636-4007](#) [641938-9](#) [65495-038](#) [65692-001LF](#) [65781-018](#)
[65781-047](#) [65817-010LF](#) [65817-015LF](#) [67095-007LF](#) [67601157](#) [68631-112](#) [699319-000](#) [70.362.1628.0](#) [70-4210](#) [70-4226B](#) [70-4853B](#) [707-](#)
[5028](#) [71.350.2428.0](#) [733-134](#) [733-162](#) [760-3052](#) [MHR-64-VUAL](#) [80.063.4001.1](#) [800-90-001-10-001000](#) [801-43-002-10-013000](#)
[801-43-006-10-002000](#) [803-43-024-10-001000](#) [803-93-012-10-001000](#) [8-1437020-4](#) [819-22-004-30-001101](#) [820-22-006-30-001101](#)
[820-22-008-30-001101](#) [821-22-002-10-001101](#)