

### 技术特性/Specifications:

额定电压 Rated voltage: 250V AC, DC  
额定电流 Rated current: 2A AC, DC  
接触电阻 Contact resistance: 20m $\Omega$  max  
绝缘电阻 Insulation resistance: 1000M $\Omega$  min  
耐压 Withstand voltage: 800V AC/minute  
环境温度 Ambient temperature: -40 $^{\circ}$ C~+105 $^{\circ}$ C  
适用线规 Wire range: AWG#30~#22



REV.	REVISION DESCRIPTION	DATE	APPD

## NOTES

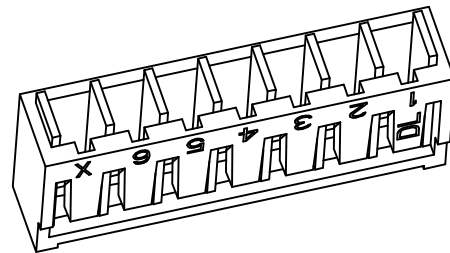
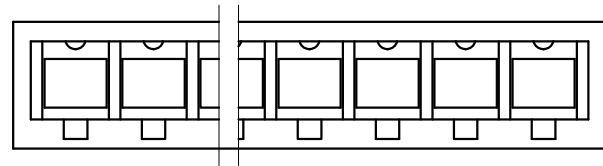
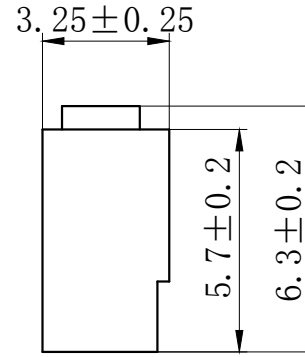
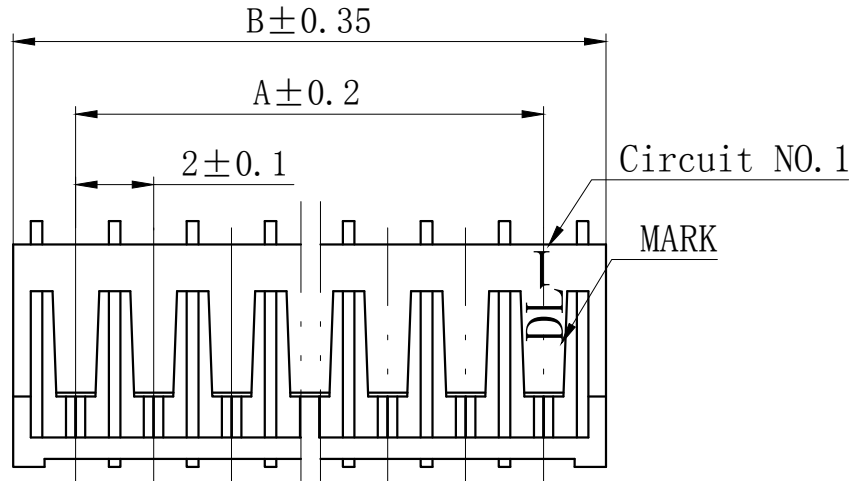
Available in 02 through 16 Circuits.  
 Material : Nylon UL94V-0(2).  
 Accepts DL20009-T Crimp Terminal.



Circuits	Product name	Dimension mm		Circuits	Product name	Dimension mm	
		A	B			A	B
2	SAN-2Y	2.00	5.50	10	SAN-10Y	18.00	21.50
3	SAN-3Y	4.00	7.50	11	SAN-11Y	20.00	23.50
4	SAN-4Y	6.00	9.50	12	SAN-12Y	22.00	25.50
5	SAN-5Y	8.00	11.50	13	SAN-13Y	24.00	27.50
6	SAN-6Y	10.00	13.50	14	SAN-14Y	26.00	29.50
7	SAN-7Y	12.00	15.50	15	SAN-15Y	28.00	31.50
8	SAN-8Y	14.00	17.50	16	SAN-16Y	30.00	33.50
9	SAN-9Y	16.00	19.50	-	-	-	-

GENERAL TOLERANCES (UNLESS SPECIFIED)		ZHE JIANG DELI CONNECTORS CO., LTD	
.X: ± 0.25	X°: ± 3.0°	PRODUCT NAME: <b>DL20009 (SAN)-Y</b>	TITLE: 2.00 mm Pitch Wire To Board Housing
.XX: ± 0.15	.X°: ± 2.0°	DR:Chen Quan Long	DATE:19/08/01
.XXX: ± 0.01	.XX°: ± 1.0°	CHKD:Wu Hui	DATE:19/08/01
FINISH: _____	 	APPD:Ren An De	DATE:19/08/01
DRAWING NO:			
		SCALE: N/A	PAGE: 1/1
		UNITS: mm	REV.: A

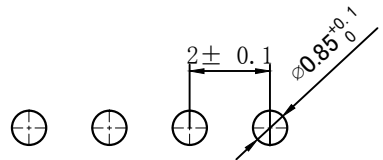
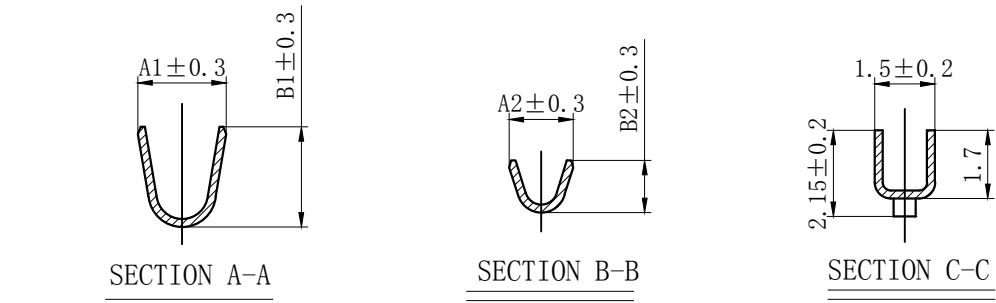
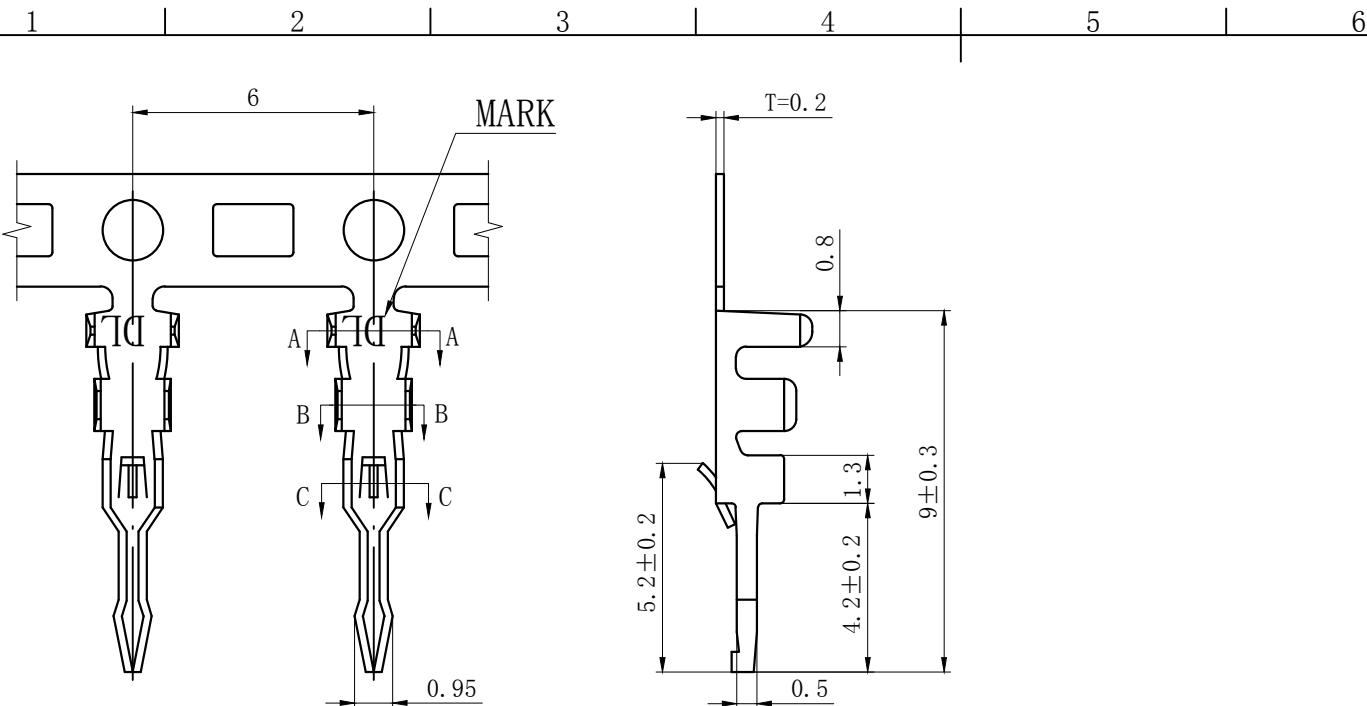

REV.	REVISION DESCRIPTION	DATE	APPD

### NOTES

Used in DL20009-Y Series Housing.  
 Accepts AWG #30~22 Wire Range.  
 Insulation O.D. =0.9~1.8mm.  
 Material : Phosphor Bronze .  
 Finish: Tin plated 2.0 μm MiN .  
 Thickness: 0.2 mm.

TYPE	Dimension mm				Applicable wires
	A1	B1	A2	B2	AWG#
SAN-T	2.2	2.5	1.6	1.3	30-24
SAN-T-G	2.3	2.4	1.9	2.0	26-22

GENERAL TOLERANCES (UNLESS SPECIFIED)		ZHE JIANG DELI CONNECTORS CO., LTD	
.X: ± 0.25	X° : ± 3.0°	PRODUCT NAME:	TITLE:
.XX: ± 0.15	.X° : ± 2.0°	DL20009 (SAN)-T	2.0 mm pitch Crimping Terminal
.XXX: ± 0.01	.XX° : ± 1.0°	DR:Chen Quan Long	DATE:2019/08/01
FINISH:		CHKD: Wu Hui	DATE:2019/08/01
DRAWING NO:		APPD:Ren An De	DATE:2019/08/01
			PART NO:
			SCALE: N/A
			PAGE: 1/1
			UNITS: mm
			REV.: A

## X-ON Electronics

Largest Supplier of Electrical and Electronic Components

*Click to view similar products for [Headers & Wire Housings](#) category:*

*Click to view products by [DLL](#) manufacturer:*

Other Similar products are found below :

[0015917161](#) [0022155065](#) [57102-F02-18ULF](#) [58102-G61-06LF](#) [582553-1](#) [01.001.5753.1](#) [0050291907](#) [02.125.8002.8](#) [609-3404](#) [61062-3](#)  
[CSU011177004](#) [622-0430](#) [622-3653LF](#) [63453-116](#) [636-1030](#) [636-1427](#) [636-3427](#) [636-4007](#) [641938-9](#) [65495-038](#) [65692-001LF](#) [65781-018](#)  
[65781-047](#) [65817-010LF](#) [65817-015LF](#) [67095-007LF](#) [67601157](#) [68631-112](#) [68645-018](#) [699319-000](#) [70.362.1628.0](#) [70-4210](#) [70-4226B](#) [70-](#)  
[4853B](#) [71.350.2428.0](#) [733-134](#) [733-162](#) [760-3052](#) [MHR-64-VUAL](#) [80.063.4001.1](#) [800-90-001-10-001000](#) [801-43-002-10-013000](#)  
[801-43-006-10-002000](#) [803-43-024-10-001000](#) [803-93-012-10-001000](#) [8-1437020-4](#) [819-22-004-30-001101](#) [820-22-006-30-001101](#)  
[820-22-008-30-001101](#) [821-22-002-10-001101](#)