

技术特性/Specifications:

额定电压 Rated voltage: 250V AC, DC
额定电流 Rated current: 3A AC, DC
接触电阻 Contact resistance: 20mΩ max
绝缘电阻 Insulation resistance: 1000MΩ min
耐压 Withstand voltage: 1000V AC/minute
环境温度 Ambient temperature: -40°C~+105°C
适用线规 Wire range: AWG#28~#20

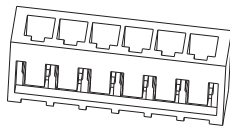

REV.	REVISION DESCRIPTION	DATE	APPD

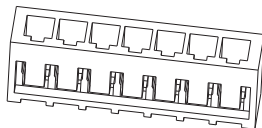
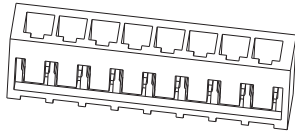
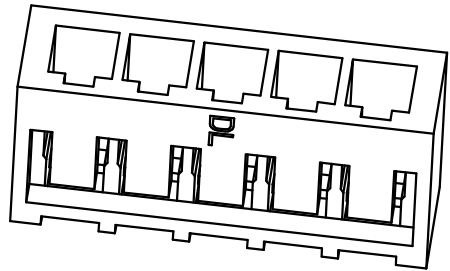
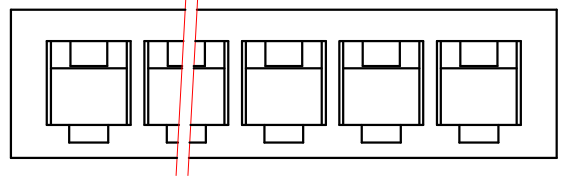
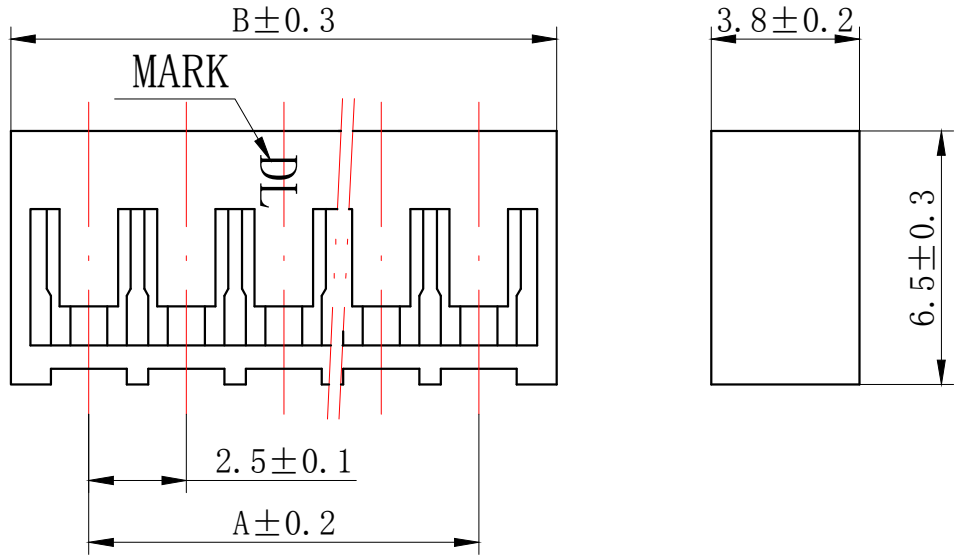

NOTES:

- 1、Rated voltage: 250V AC.DC
- 2、Rated current: 3A AC.DC
- 3、Contact resistance: $\leq 20 \text{ m}\Omega$
- 4、Insulation resistance: $\geq 1000 \text{ M}\Omega$
- 5、Withstand voltage : $\geq 1000 \text{ V AC/minute}$
- 6、Ambient temperature: $-40^\circ\text{C} \sim 105^\circ\text{C}$
- 7、Materials: Nylon UL94-V0(2)
- 8、Matched RoHS criteria

Circuits	Product name	Dimension mm		Circuits	Product name	Dimension mm	
		A	B			A	B
2	SCNB-2Y	2.5	6.5	10	SCNB-10Y	22.5	26.5
3	SCNB-3Y	5.0	9.0	11	SCNB-11Y	25.0	29.0
4	SCNB-4Y	7.5	11.5	12	SCNB-12Y	27.5	31.5
5	SCNB-5Y	10.0	14.0	13	SCNB-13Y	30.0	34.0
6	SCNB-6Y	12.5	16.5	14	SCNB-14Y	32.5	36.5
7	SCNB-7Y	15.0	19.0	15	SCNB-15Y	35.0	39.0
8	SCNB-8Y	17.5	21.5	~	~	~	~
9	SCNB-9Y	20.0	24.0	20	SCNB-20Y	47.5	51.50

GENERAL TOLERANCES (UNLESS SPECIFIED)		ZHE JIANG DELI CONNECTORS CO., LTD	
.X: ± 0.25	X°: $\pm 3.0^\circ$	PRODUCT NAME: DL25010 (SCNB) -Y	TITLE: 2.50 mm Pitch Wire To Board Housing
.XX: ± 0.15	.X°: $\pm 2.0^\circ$	DR: Chen Quan Long	DATE: 19/08/01
.XXX: ± 0.01	.XX°: $\pm 1.0^\circ$	CHKD: Wu Hui	DATE: 19/08/01
FINISH:		APPD: Ren An De	DATE: 19/08/01
DRAWING NO:			

REV.	REVISION DESCRIPTION	DATE	APPD

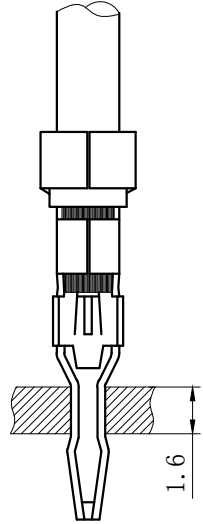
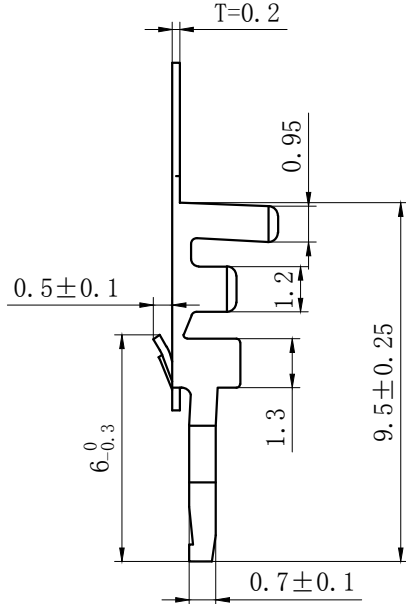
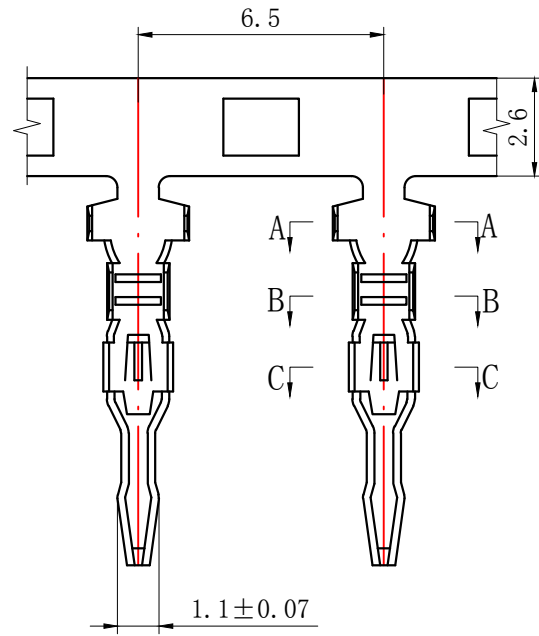

NOTES

Used in DL25009-Y Series Housing.
 Accepts AWG #28~20 Wire Range.
 Insulation O.D.=0.9~1.9 mm.
 Material : Phosphor Bronze .
 Finish: Tin plated.
 Thickness: 0.2 mm.

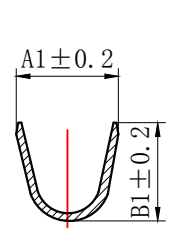

SECTION A-A

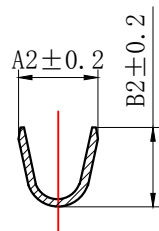

SECTION B-B

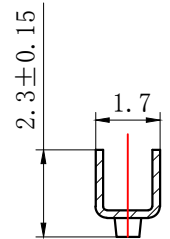

SECTION C-C

Product name	Dimension mm				适用线规 AWG#
	A1	B1	A2	B2	
SCN-T-G	2.7	2.6	2.1	2.1	24-20
SCN-T	2.7	2.6	1.8	1.4	28-22

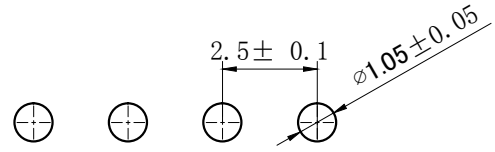

PCB LAYOUT

GENERAL TOLERANCES (UNLESS SPECIFIED)		ZHE JIANG DELI CONNECTORS CO., LTD	
.X: ± 0.25	X°: ± 3.0°	PRODUCT NAME: DL25009 (SCN) -T	
.XX: ± 0.15	.X°: ± 2.0°	TITLE: 2.00 mm Pitch Wire To Board Crimp Terminal	
.XXX: ± 0.01	.XX°: ± 1.0°	DR:Chen Quan Long	DATE:20.3.31
FINISH:		CHKD:Wu Hui	DATE:20.3.31
DRAWING NO:		APPD:Ren An De	DATE:20.3.31
		SCALE: N/A	PAGE: 1/1
		UNITS: mm	REV.: A

X-ON Electronics

Largest Supplier of Electrical and Electronic Components

Click to view similar products for [Headers & Wire Housings](#) category:

Click to view products by [DLL](#) manufacturer:

Other Similar products are found below :

[0015917161](#) [0022155065](#) [57102-F02-18ULF](#) [58102-G61-06LF](#) [582553-1](#) [01.001.5753.1](#) [0050291907](#) [02.125.8002.8](#) [609-3404](#) [61062-3](#)
[CSU011177004](#) [622-0430](#) [622-3653LF](#) [63453-116](#) [636-1030](#) [636-1427](#) [636-3427](#) [636-4007](#) [641938-9](#) [65495-038](#) [65692-001LF](#) [65781-018](#)
[65781-047](#) [65817-010LF](#) [65817-015LF](#) [67095-007LF](#) [67601157](#) [68631-112](#) [68645-018](#) [699319-000](#) [70.362.1628.0](#) [70-4210](#) [70-4226B](#) [70-](#)
[4853B](#) [71.350.2428.0](#) [733-134](#) [733-162](#) [760-3052](#) [MHR-64-VUAL](#) [80.063.4001.1](#) [800-90-001-10-001000](#) [801-43-002-10-013000](#)
[801-43-006-10-002000](#) [803-43-024-10-001000](#) [803-93-012-10-001000](#) [8-1437020-4](#) [819-22-004-30-001101](#) [820-22-006-30-001101](#)
[820-22-008-30-001101](#) [821-22-002-10-001101](#)