

**技术特性/Specifications:**

额定电压 Rated voltage: 250V AC, DC  
额定电流 Rated current: 3A AC, DC  
接触电阻 Contact resistance: 20m $\Omega$  max  
绝缘电阻 Insulation resistance: 1000M $\Omega$  min  
耐压 Withstand voltage: 1000V AC/minute  
环境温度 Ambient temperature: -40 $^{\circ}$ C~+105 $^{\circ}$ C  
适用线规 Wire range: AWG#28~#20

REV.	REVISION DESCRIPTION	DATE	APPD
B	优化电路板孔径尺寸	22.9.6	Wuhui

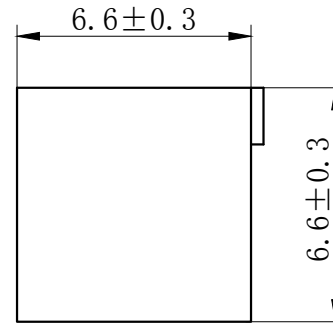
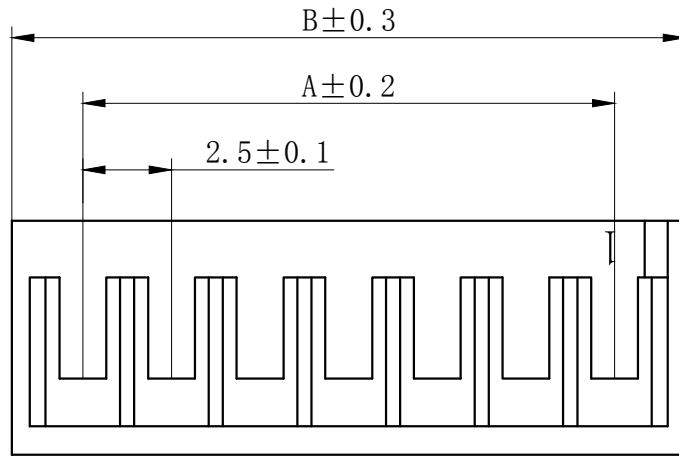

## NOTES

Available in 04 through 40 Circuits.  
 Material : Nylon UL94V-0(2).  
 Accepts DL25041-T Crimp Terminal.

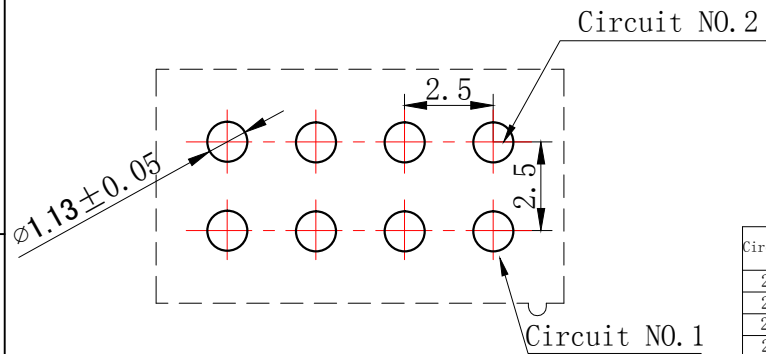
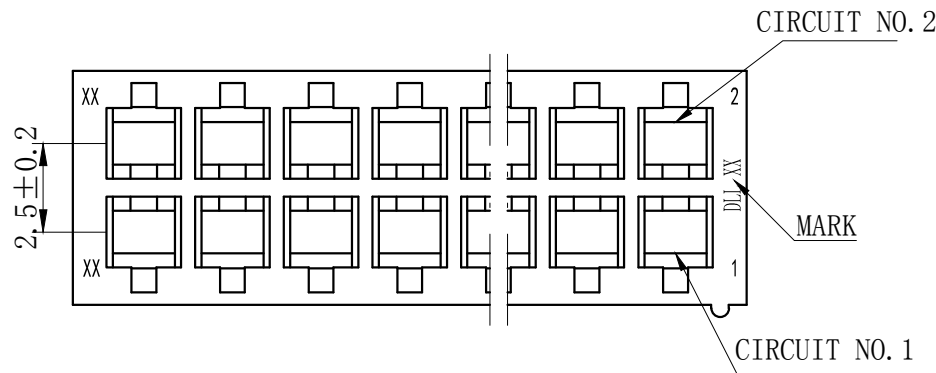

Circuits	Product name	Dimension mm		Circuits	Product name	Dimension mm	
		A	B			A	B
2X2	SCND-4Y	2.50	6.50	2X10	SCND-20Y	22.50	26.50
2X3	SCND-6Y	5.00	9.00	2X11	SCND-22Y	25.00	29.00
2X4	SCND-8Y	7.50	11.50	2X12	SCND-24Y	27.50	31.50
2X5	SCND-10Y	10.00	14.00	2X13	SCND-26Y	30.00	34.00
2X6	SCND-12Y	12.50	16.50	2X14	SCND-28Y	32.50	36.50
2X7	SCND-14Y	15.00	19.00	2X15	SCND-30Y	35.00	39.00
2X8	SCND-16Y	17.50	21.50	~	~	~	~
2X9	SCND-18Y	20.00	24.00	2X20	SCND-40Y	47.50	51.50

### GENERAL TOLERANCES (UNLESS SPECIFIED)

.X: ± 0.25	X° : ± 3.0°
.XX: ± 0.15	.X° : ± 2.0°
.XXX: ± 0.01	.XX° : ± 1.0°

FINISH: \_\_\_\_\_

DRAWING NO: \_\_\_\_\_

## ZHE JIANG DELI CONNECTORS CO., LTD

PRODUCT NAME: <b>DL25041-Y (SCND-Y)</b>		TITLE: 2.50 mm Pitch Wire To Board Housing	
DR: Yuan Jun Rong	DATE:21/08/01	PART NO:	
CHKD:Wu Hui	DATE:21/08/01	SCALE: N/A	PAGE: 1/1
APPD:Ren An De	DATE:21/08/01	UNITS: mm	REV. : B

REV.	REVISION DESCRIPTION	DATE	APPD

**NOTES**

Used in DL25009-Y Series Housing.  
 Accepts AWG #28~20 Wire Range.  
 Insulation O.D.=0.9~1.9 mm.  
 Material : Phosphor Bronze .  
 Finish: Tin plated.  
 Thickness: 0.2 mm.

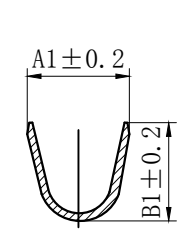
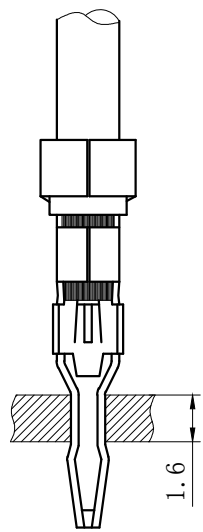
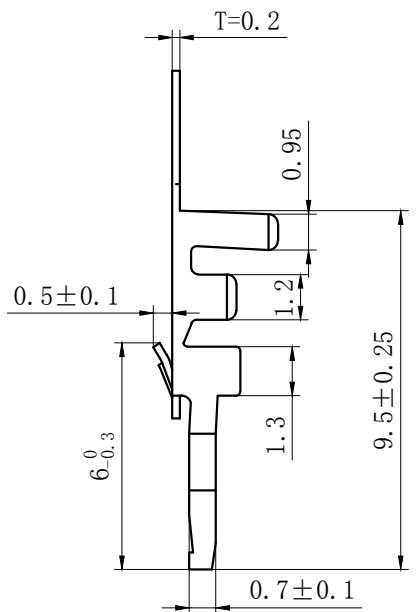
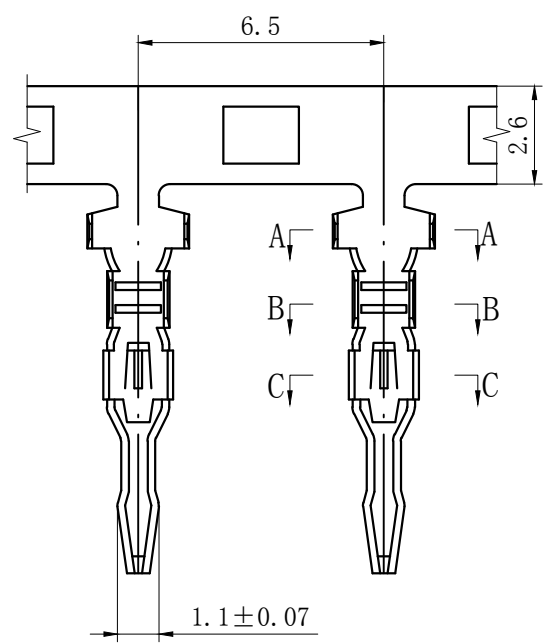

SECTION A-A

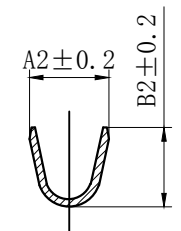

SECTION B-B

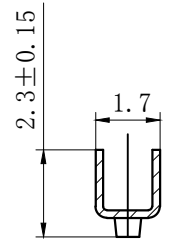

SECTION C-C

TYPE	Dimension mm				适用线规 AWG#
	A1	B1	A2	B2	
SCN-T-G	2.7	2.6	2.1	2.1	24-20
SCN-T	2.7	2.6	1.8	1.4	28-22

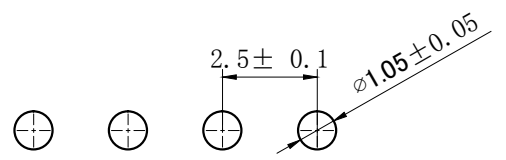

PCB LAYOUT

GENERAL TOLERANCES (UNLESS SPECIFIED)		ZHE JIANG DELI CONNECTORS CO., LTD	
.X: ± 0.25	.X°: ± 3.0°	PRODUCT NAME: DL25009-T (SCN-T)	
.XX: ± 0.15	.XX°: ± 2.0°	TITLE: 2.00 mm Pitch Wire To Board Crimp Terminal	
.XXX: ± 0.01	.XXX°: ± 1.0°	DR:Chen Quan Long	DATE:20.3.31
FINISH:		CHKD:Wu Hui	DATE:20.3.31
DRAWING NO:		APPD:Ren An De	DATE:20.3.31
		SCALE: N/A	PAGE: 1/1
		UNITS: mm	REV.: A

## X-ON Electronics

Largest Supplier of Electrical and Electronic Components

*Click to view similar products for [Headers & Wire Housings](#) category:*

*Click to view products by [DLL](#) manufacturer:*

Other Similar products are found below :

[0015917161](#) [0022155065](#) [57102-F02-18ULF](#) [58102-G61-06LF](#) [582553-1](#) [01.001.5753.1](#) [0050291907](#) [02.125.8002.8](#) [609-3404](#) [61062-3](#)  
[CSU011177004](#) [622-0430](#) [622-3653LF](#) [63453-116](#) [636-1030](#) [636-1427](#) [636-3427](#) [636-4007](#) [641938-9](#) [65495-038](#) [65692-001LF](#) [65781-018](#)  
[65781-047](#) [65817-010LF](#) [65817-015LF](#) [67095-007LF](#) [67601157](#) [68631-112](#) [68645-018](#) [699319-000](#) [70.362.1628.0](#) [70-4210](#) [70-4226B](#) [70-](#)  
[4853B](#) [71.350.2428.0](#) [733-134](#) [733-162](#) [760-3052](#) [MHR-64-VUAL](#) [80.063.4001.1](#) [800-90-001-10-001000](#) [801-43-002-10-013000](#)  
[801-43-006-10-002000](#) [803-43-024-10-001000](#) [803-93-012-10-001000](#) [8-1437020-4](#) [819-22-004-30-001101](#) [820-22-006-30-001101](#)  
[820-22-008-30-001101](#) [821-22-002-10-001101](#)