

技术特性/Specifications:

额定电压 Rated voltage: 125V AC, DC
额定电流 Rated current: 1A AC, DC
接触电阻 Contact resistance: 20m Ω max
绝缘电阻 Insulation resistance: 100M Ω min
耐压 Withstand voltage: 250V AC/minute
环境温度 Ambient temperature: -40 $^{\circ}$ C~+105 $^{\circ}$ C
适用线规 Wire range: AWG#32~#28

REV.	REVISION DESCRIPTION	DATE	APPD

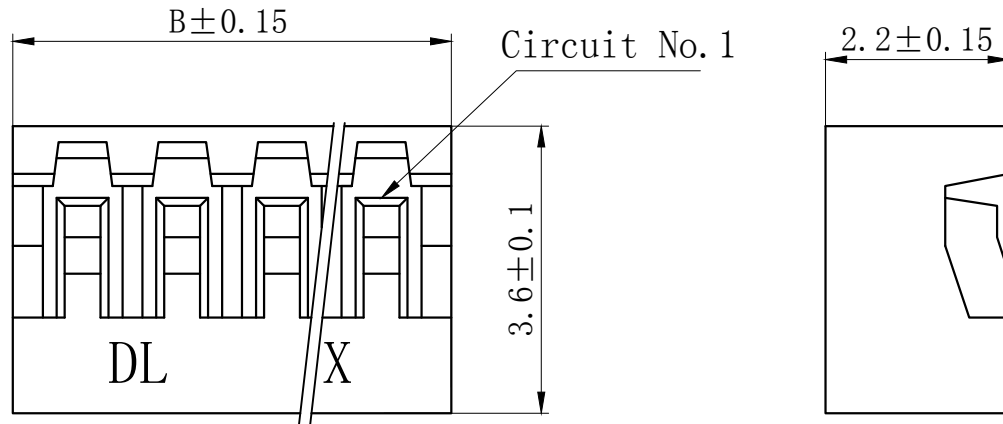

NOTES

Available in 02 through 15 Circuits.

Material : Nylon UL94V-0(2).

Accepts DL12507-T Crimp Terminal.

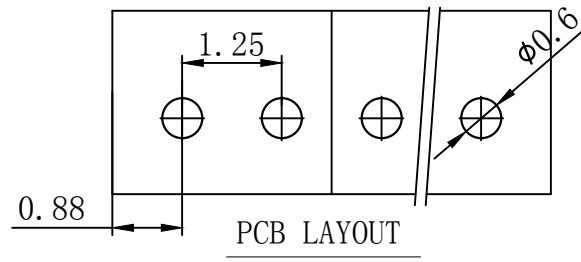
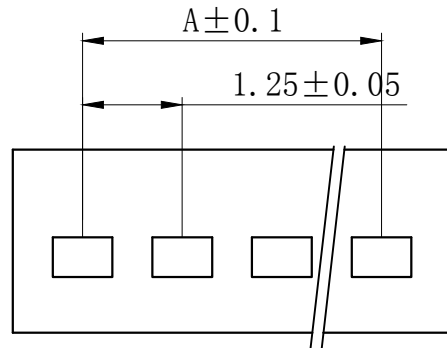

Circuits	Type	Dimension mm		Circuits	Type	Dimension mm	
		A	B			A	B
2	SGN-2Y	1.25	3.00	9	SGN-9Y	10.00	11.75
3	SGN-3Y	2.50	4.25	10	SGN-10Y	11.25	13.00
4	SGN-4Y	3.75	5.50	11	SGN-11Y	12.50	14.25
5	SGN-5Y	5.00	6.75	12	SGN-12Y	13.75	15.50
6	SGN-6Y	6.25	8.00	13	SGN-13Y	15.00	16.75
7	SGN-7Y	7.50	9.25	14	SGN-14Y	16.25	18.00
8	SGN-8Y	8.75	10.50	15	SGN-15Y	17.50	19.25

GENERAL TOLERANCES (UNLESS SPECIFIED)		ZHE JIANG DELI CONNECTORS CO., LTD			
.X: ± 0.25	X°: ± 3.0°	PRODUCT NAME:		TITLE:	
.XX: ± 0.15	.X°: ± 2.0°	DL12507 (SGN)-Y		1.25 mm Pitch Housing	
.XXX: ± 0.01	.XX°: ± 1.0°	DR: Chen Quan Long	DATE: 21/06/07	PART NO:	
FINISH:		CHKD: Wu Hui	DATE: 21/06/07	SCALE: N/A	PAGE: 1/1
DRAWING NO:		APPD: Ren An De	DATE: 21/06/07	UNITS: mm	REV.: A

REV.	REVISION DESCRIPTION	DATE	APPD

NOTES

Used in DL12507-Y Series Housing.
 Accepts AWG #28~32 Wire Range.
 0.08~ 0.032 mm² .
 Insulation O.D.=0.7~1.0 mm.
 Material : Phosphor Bronze .
 Finish: Tin plated.
 Thickness: 0.15 mm.

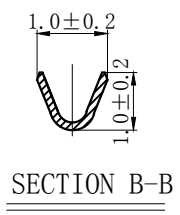
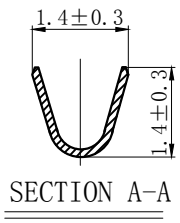
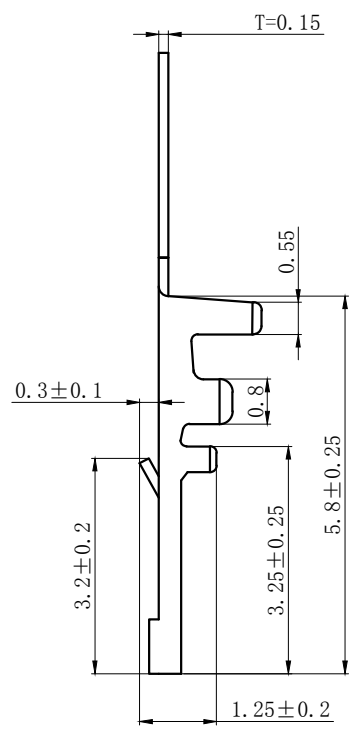
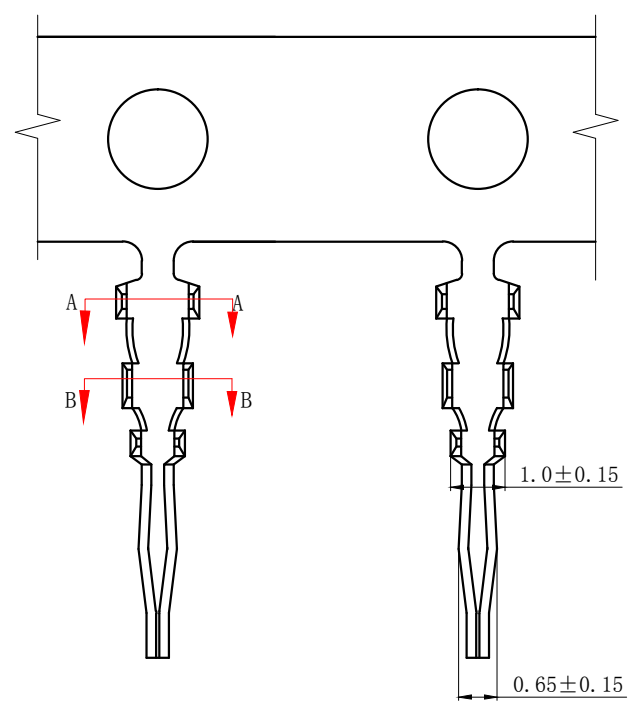

GENERAL TOLERANCES (UNLESS SPECIFIED)		ZHE JIANG DELI CONNECTORS CO., LTD	
.X: ± 0.25	X° : ± 3.0°	PRODUCT NAME:	TITLE:
.XX: ± 0.15	.X° : ± 2.0°	DL12507 (SGN)-T	1.25 mm Pitch Crimp Terminal
.XXX: ± 0.01	.XX° : ± 1.0°	DR:Chen Quan Long	DATE:21/08/01
FINISH:		CHKD: Wu Hui	DATE:21/08/01
DRAWING NO:		APPD:Ren An De	DATE:21/08/01
		SCALE: N/A	PAGE: 1/1
		UNITS: mm	REV.: A

X-ON Electronics

Largest Supplier of Electrical and Electronic Components

Click to view similar products for [Headers & Wire Housings](#) category:

Click to view products by [DLL](#) manufacturer:

Other Similar products are found below :

[0015917161](#) [0022155065](#) [57102-F02-18ULF](#) [58102-G61-06LF](#) [582553-1](#) [01.001.5753.1](#) [0050291907](#) [02.125.8002.8](#) [609-3404](#) [61062-3](#)
[CSU011177004](#) [622-0430](#) [622-3653LF](#) [63453-116](#) [636-1030](#) [636-1427](#) [636-3427](#) [636-4007](#) [641938-9](#) [65495-038](#) [65692-001LF](#) [65781-018](#)
[65781-047](#) [65817-010LF](#) [65817-015LF](#) [67095-007LF](#) [67601157](#) [68631-112](#) [68645-018](#) [699319-000](#) [70.362.1628.0](#) [70-4210](#) [70-4226B](#) [70-](#)
[4853B](#) [71.350.2428.0](#) [733-134](#) [733-162](#) [760-3052](#) [MHR-64-VUAL](#) [80.063.4001.1](#) [800-90-001-10-001000](#) [801-43-002-10-013000](#)
[801-43-006-10-002000](#) [803-43-024-10-001000](#) [803-93-012-10-001000](#) [8-1437020-4](#) [819-22-004-30-001101](#) [820-22-006-30-001101](#)
[820-22-008-30-001101](#) [821-22-002-10-001101](#)