



技术特性/Specifications:

额定电压 Rated voltage: 250V AC, DC
额定电流 Rated current: 3A AC, DC
接触电阻 Contact resistance: 20m Ω max
绝缘电阻 Insulation resistance: 1000M Ω min
耐压 Withstand voltage: 1000V AC/minute
环境温度 Ambient temperature: -40 $^{\circ}$ C~+105 $^{\circ}$ C
适用线规 Wire range: AWG#28~#20

| | | | |
|------|----------------------|---------|----|
| REV. | REVISION DESCRIPTION | DATE | |
| B | 更新外观结构 | 19.5.29 | Wu |

A

B

C

D

E

F

A

B

C

D

E

F



NOTES

Available in 02 through 20 Circuits.
 Mates with DL25002-Y Series Housing.
 Material : LCP UL94V-0.
 Pin Material : Brass.Tin-plated .

| | | | | | |
|----|----|-----|-----|----|---------|
| 3 | ③ | 基座 | LCP | 1 | UL94V-0 |
| 2 | ② | 焊片 | 黄铜 | 2 | 镀锡 |
| 1 | ① | 接触件 | 黄铜 | N* | 镀锡 |
| 序号 | 图号 | 名称 | 材料 | 数量 | 附件 |

| Type | Product name | Dimension mm | | | | Type | Product name | Dimension mm | | | |
|------|--------------|--------------|-------|-------|-------|------|--------------|--------------|-------|-------|-------|
| | | A | B | C | D | | | A | B | C | D |
| 2 | TJC3B-2AB | 2.50 | 10.00 | 5.95 | 2.50 | 12 | TJC3B-12AB | 27.50 | 35.00 | 30.95 | 24.50 |
| 3 | TJC3B-3AB | 5.00 | 12.50 | 8.45 | 2.50 | 13 | TJC3B-13AB | 30.00 | 37.50 | 33.45 | 27.00 |
| 4 | TJC3B-4AB | 7.50 | 15.00 | 10.95 | 4.50 | 14 | TJC3B-14AB | 32.50 | 40.00 | 35.95 | 29.50 |
| 5 | TJC3B-5AB | 10.00 | 17.50 | 13.45 | 7.00 | 15 | TJC3B-15AB | 35.00 | 42.50 | 38.45 | 32.00 |
| 6 | TJC3B-6AB | 12.50 | 20.00 | 15.95 | 9.50 | 16 | TJC3B-16AB | 37.50 | 45.00 | 40.95 | 34.50 |
| 7 | TJC3B-7AB | 15.00 | 22.50 | 18.45 | 12.00 | 17 | TJC3B-17AB | 40.00 | 47.50 | 43.45 | 37.00 |
| 8 | TJC3B-8AB | 17.50 | 25.00 | 20.95 | 14.50 | 18 | TJC3B-18AB | 42.50 | 50.00 | 45.95 | 39.50 |
| 9 | TJC3B-9AB | 20.00 | 27.50 | 23.45 | 17.00 | 19 | TJC3B-19AB | 45.00 | 52.50 | 48.45 | 42.00 |
| 10 | TJC3B-10AB | 22.50 | 30.00 | 25.95 | 19.50 | 20 | TJC3B-20AB | 47.50 | 55.00 | 50.95 | 44.50 |
| 11 | TJC3B-11AB | 25.00 | 32.50 | 28.45 | 22.00 | | | | | | |

| | | | | | |
|---------------------------------------|--------------|-------------------------------------|--|--|--|
| GENERAL TOLERANCES (UNLESS SPECIFIED) | | ZHE JIANG DELI CONNECTORS CO., LTD | | | |
| .X: ± 0.25 | X°: ± 3.0° | PRODUCT NAME: DL25002 (TJC3B)-AB | | TITLE: 2.50 mm Pitch Wire To Board SMT Wafer | |
| .XX: ± 0.15 | .X°: ± 2.0° | DR: Wang Li Te | | DATE: 18/03/07 | |
| .XXX: ± 0.01 | .XX°: ± 1.0° | FINISH: | | PART NO: | |
| DRAWING NO: | | CHKD: ZhangTing | | DATE: 18/03/07 | |
| | | APPD: Wu Hui | | DATE: 18/03/07 | |
| | | SCALE: N/A | | PAGE: 1/1 | |
| | | UNITS: mm | | REV.: B | |

| REV. | REVISION DESCRIPTION | DATE | APPD |
|------|----------------------|--------|------|
| B | 自动包装检测需要优化外观 | 19.4.2 | WU |

NOTES

Available in 02 through 20 Circuits.
 Mates with DL25002-Y Series Housing.
 Material : LCP UL94V-0.
 Pin Material : Brass.Tin-plated .

| | | | | | |
|----|----|-----|-----|----|---------|
| 3 | ③ | 基座 | LCP | 1 | UL94V-0 |
| 2 | ② | 焊片 | 黄铜 | 2 | 镀锡 |
| 1 | ① | 接触件 | 黄铜 | N* | 镀锡 |
| 序号 | 图号 | 名称 | 材料 | 数量 | 附件 |

| Type | Product name | Dimension mm | | | | Type | Product name | Dimension mm | | | |
|------|--------------|--------------|-------|-------|-------|------|--------------|--------------|-------|-------|-------|
| | | A | B | C | D | | | A | B | C | D |
| 2 | TJC3B-2AWB | 2.50 | 10.00 | 5.95 | 2.50 | 12 | TJC3B-12AWB | 27.50 | 35.00 | 30.95 | 24.50 |
| 3 | TJC3B-3AWB | 5.00 | 12.50 | 8.45 | 2.50 | 13 | TJC3B-13AWB | 30.00 | 37.50 | 33.45 | 27.00 |
| 4 | TJC3B-4AWB | 7.50 | 15.00 | 10.95 | 4.50 | 14 | TJC3B-14AWB | 32.50 | 40.00 | 35.95 | 29.50 |
| 5 | TJC3B-5AWB | 10.00 | 17.50 | 13.45 | 7.00 | 15 | TJC3B-15AWB | 35.00 | 42.50 | 38.45 | 32.00 |
| 6 | TJC3B-6AWB | 12.50 | 20.00 | 15.95 | 9.50 | 16 | TJC3B-16AWB | 37.50 | 45.00 | 40.95 | 34.50 |
| 7 | TJC3B-7AWB | 15.00 | 22.50 | 18.45 | 12.00 | 17 | TJC3B-17AWB | 40.00 | 47.50 | 43.45 | 37.00 |
| 8 | TJC3B-8AWB | 17.50 | 25.00 | 20.95 | 14.50 | 18 | TJC3B-18AWB | 42.50 | 50.00 | 45.95 | 39.50 |
| 9 | TJC3B-9AWB | 20.00 | 27.50 | 23.45 | 17.00 | 19 | TJC3B-19AWB | 45.00 | 52.50 | 48.45 | 42.00 |
| 10 | TJC3B-10AWB | 22.50 | 30.00 | 25.95 | 19.50 | 20 | TJC3B-20AWB | 47.50 | 55.00 | 50.95 | 44.50 |
| 11 | TJC3B-11AWB | 25.00 | 32.50 | 28.45 | 22.00 | | | | | | |

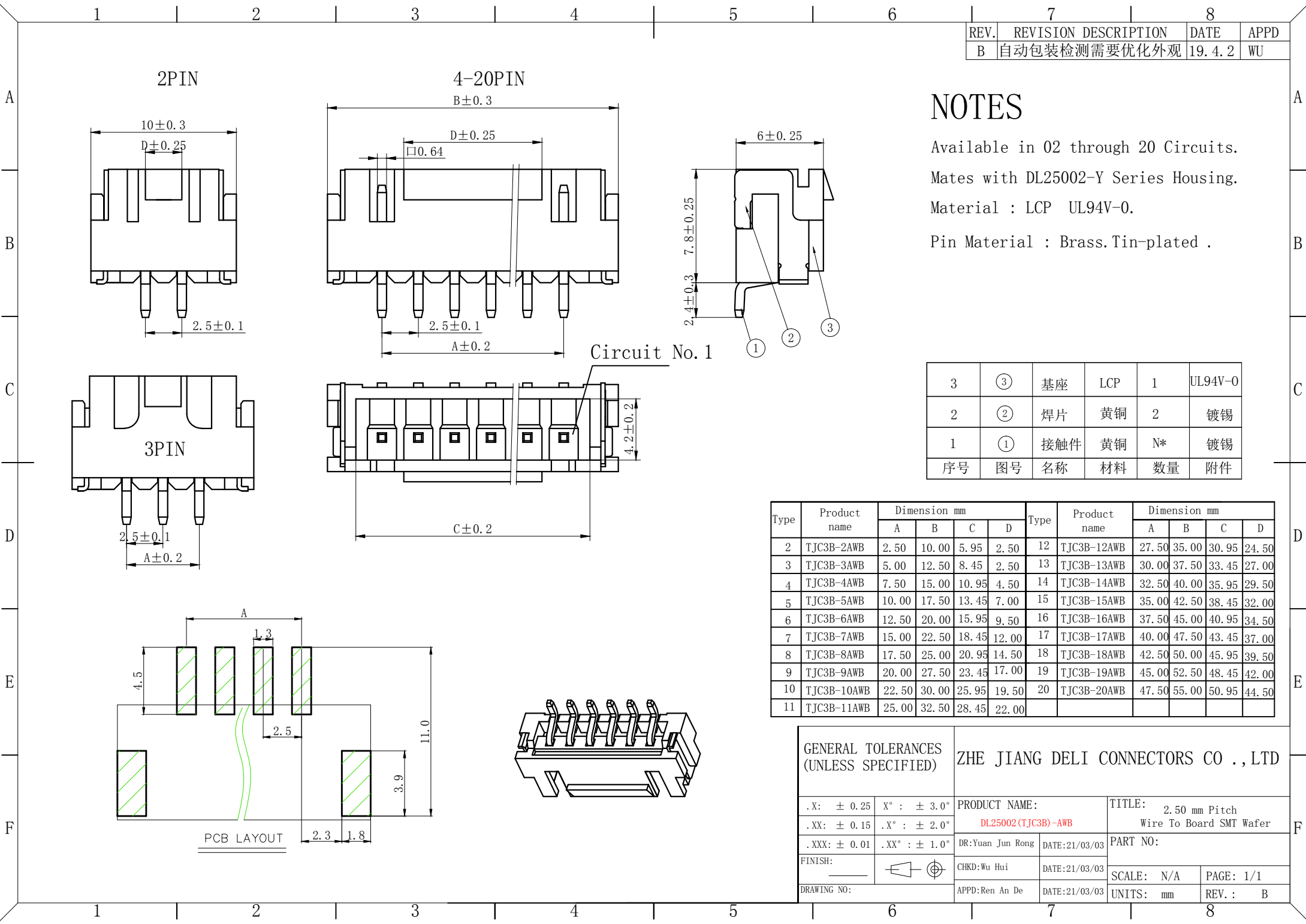

| GENERAL TOLERANCES (UNLESS SPECIFIED) | | ZHE JIANG DELI CONNECTORS CO., LTD | |
|---------------------------------------|--------------|------------------------------------|--|
| .X: ± 0.25 | X°: ± 3.0° | PRODUCT NAME: | TITLE: 2.50 mm Pitch Wire To Board SMT Wafer |
| .XX: ± 0.15 | .X°: ± 2.0° | DL25002(TJC3B)-AWB | |
| .XXX: ± 0.01 | .XX°: ± 1.0° | DR:Yuan Jun Rong | DATE:21/03/03 |
| FINISH: | | CHKD:Wu Hui | DATE:21/03/03 |
| DRAWING NO: | | APPD:Ren An De | DATE:21/03/03 |
| | | PART NO: | SCALE: N/A |
| | | | PAGE: 1/1 |
| | | UNITS: mm | REV.: B |

| | | | |
|------|----------------------|---------|----|
| REV. | REVISION DESCRIPTION | DATE | Wu |
| B | 更新外观结构 | 19.5.29 | |

2PIN

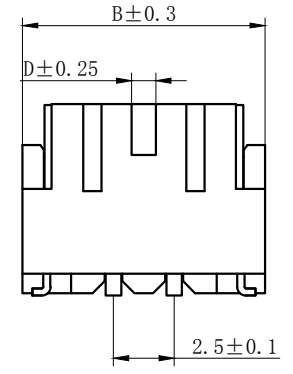

3-6PIN

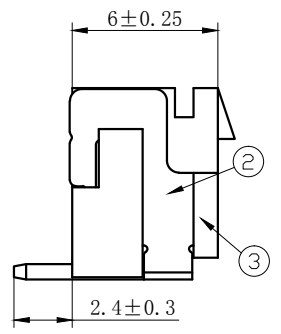

NOTES

Available in 02 through 05 Circuits.
 Mates with DL25002-Y Series Housing.
 Material : LCP UL94V-0.
 Pin Material : Brass.Tin-plated .



| Type | Product name | Dimension mm | | | |
|------|--------------|--------------|-------|-------|-----|
| | | A | B | C | D |
| 2 | TJC3B-2ABJ | 2.50 | 10.00 | 5.95 | 1.0 |
| 3 | TJC3B-3ABJ | 5.00 | 12.50 | 8.45 | 1.2 |
| 4 | TJC3B-4ABJ | 7.50 | 15.00 | 10.95 | 2.5 |
| 5 | TJC3B-5ABJ | 10.00 | 17.50 | 13.45 | 3.5 |

| | | | | | |
|----|----|-----|-----|----|---------|
| 3 | ③ | 基座 | LCP | 1 | UL94V-0 |
| 2 | ② | 焊片 | 黄铜 | 2 | 镀锡 |
| 1 | ① | 接触件 | 黄铜 | N* | 镀锡 |
| 序号 | 图号 | 名称 | 材料 | 数量 | 附件 |

| GENERAL TOLERANCES (UNLESS SPECIFIED) | | ZHE JIANG DELI CONNECTORS CO., LTD | | | |
|---------------------------------------|--------------|-------------------------------------|----------------|--|-----------|
| .X: ± 0.25 | X°: ± 3.0° | PRODUCT NAME: DL25002(TJC3B)-ABJ | | TITLE: 2.50 mm Pitch Wire To Board SMT Wafer | |
| .XX: ± 0.15 | .X°: ± 2.0° | DR: Wang Li Te | DATE: 18/03/07 | PART NO: | |
| .XXX: ± 0.01 | .XX°: ± 1.0° | CHKD: ZhangTing | DATE: 18/03/07 | SCALE: N/A | PAGE: 1/1 |
| FINISH: | | APPD: Wu Hui | DATE: 18/03/07 | UNITS: mm | REV.: B |
| DRAWING NO: | | | | | |

| REV. | REVISION DESCRIPTION | DATE | APPD |
|------|----------------------|--------|------|
| B | 自动包装检测需要优化外观 | 19.4.2 | WU |

2PIN

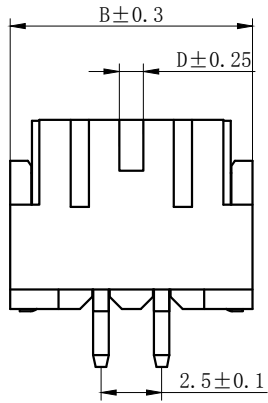

3-6PIN

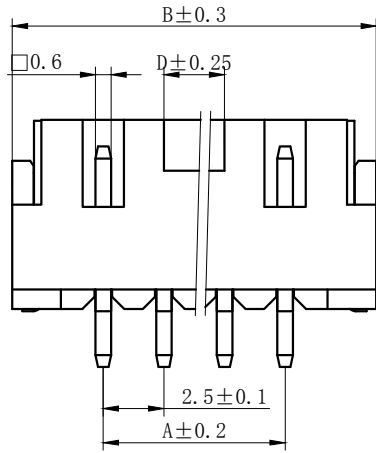

Circuit No. 1

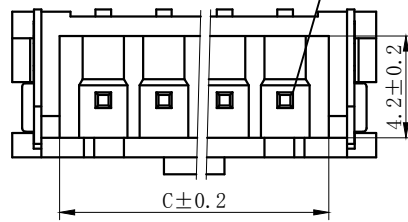

NOTES

Available in 02 through 06 Circuits.
 Mates with DL25002-Y Series Housing.
 Material : LCP UL94V-0.
 Pin Material : Brass.Tin-plated .

| Type | Product name | Dimension mm | | | |
|------|--------------|--------------|-------|-------|-----|
| | | A | B | C | D |
| 2 | TJC3B-2AWBJ | 2.50 | 10.00 | 5.95 | 1.0 |
| 3 | TJC3B-3AWBJ | 5.00 | 12.50 | 8.45 | 1.2 |
| 4 | TJC3B-4AWBJ | 7.50 | 15.00 | 10.95 | 2.5 |
| 5 | TJC3B-5AWBJ | 10.00 | 17.50 | 13.45 | 3.5 |
| 6 | TJC3B-6AWBJ | 12.50 | 20.00 | 15.95 | 6.0 |

| | | | | | |
|----|----|-----|-----|----|---------|
| 3 | ③ | 基座 | LCP | 1 | UL94V-0 |
| 2 | ② | 焊片 | 黄铜 | 2 | 镀锡 |
| 1 | ① | 接触件 | 黄铜 | N* | 镀锡 |
| 序号 | 图号 | 名称 | 材料 | 数量 | 附件 |

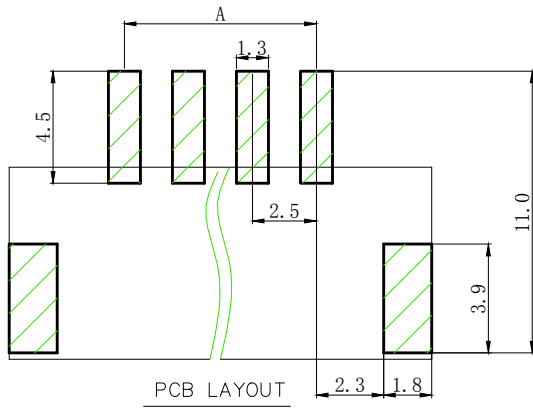

| GENERAL TOLERANCES (UNLESS SPECIFIED) | | ZHE JIANG DELI CONNECTORS CO ., LTD | | | |
|---------------------------------------|---------------|--------------------------------------|---------------|--|-----------|
| .X: ± 0.25 | X° : ± 3.0° | PRODUCT NAME: DL25002(TJC3B)-AWBJ | | TITLE: 2.50 mm Pitch Wire To Board SMT Wafer | |
| .XX: ± 0.15 | .X° : ± 2.0° | DR:Yuan Jun Rong | DATE:21/03/03 | PART NO: | |
| .XXX: ± 0.01 | .XX° : ± 1.0° | CHKD:Wu Hui | DATE:21/03/03 | SCALE: N/A | PAGE: 1/1 |
| DRAWING NO: | | APPD:Ren An De | DATE:21/03/03 | UNITS: mm | REV. : B |

| | | | |
|------|----------------------|------|------|
| REV. | REVISION DESCRIPTION | DATE | APPD |
| | | | |

A

B

C

D

E

F

A

B

C

D

E

F

1

2

3

4

5

6

7

8



Circuit No. 1

MARK



3-5PIN

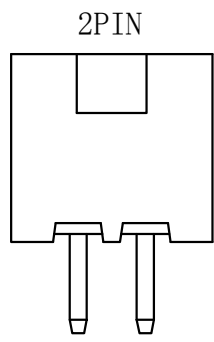

2PIN

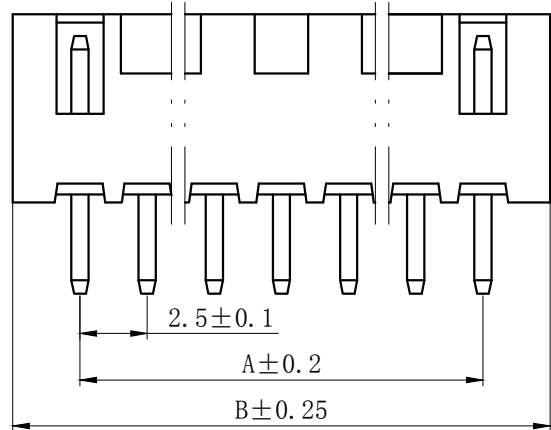

2.5±0.1

A±0.2

B±0.25

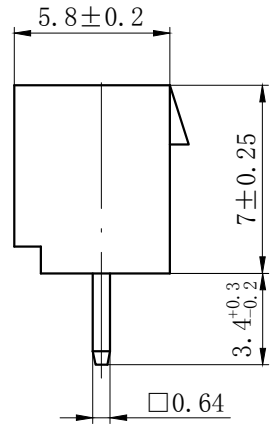

5.8±0.2

7±0.25

3.4+0.3-0.2

□0.64



C±0.2



A±0.2

2.5±0.1

φ0.95+0.1-0

PCB LAYOUT

NOTES

Available in 02 through 20 Circuits.
Mates with DL25002-Y Series Housing.
Material : Nylon UL94V-0 (2) .
0.64mm Square Pin.
Pin Material : Brass / Tin-Plated.

| Circuits | Product name | Dimension mm | | | Circuits | Product name | Dimension mm | | |
|----------|--------------|--------------|-------|-------|----------|--------------|--------------|-------|-------|
| | | A | B | C | | | A | B | C |
| 2 | TJC3B-2A-Z | 2.50 | 7.50 | 5.80 | 11 | TJC3B-11A-Z | 25.00 | 30.00 | 28.50 |
| 3 | TJC3B-3A-Z | 5.00 | 10.00 | 8.30 | 12 | TJC3B-12A-Z | 27.50 | 32.50 | 31.00 |
| 4 | TJC3B-4A-Z | 7.50 | 12.50 | 11.00 | 13 | TJC3B-13A-Z | 30.00 | 35.00 | 33.50 |
| 5 | TJC3B-5A-Z | 10.00 | 15.00 | 13.50 | 14 | TJC3B-14A-Z | 32.50 | 37.50 | 36.00 |
| 6 | TJC3B-6A-Z | 12.50 | 17.50 | 16.00 | 15 | TJC3B-15A-Z | 35.00 | 40.00 | 38.50 |
| 7 | TJC3B-7A-Z | 15.00 | 20.00 | 18.50 | 16 | TJC3B-16A-Z | 37.50 | 42.50 | 41.00 |
| 8 | TJC3B-8A-Z | 17.50 | 22.50 | 21.00 | 17 | TJC3B-17A-Z | 40.00 | 45.00 | 43.50 |
| 9 | TJC3B-9A-Z | 20.00 | 25.00 | 23.50 | ~ | ~ | ~ | ~ | ~ |
| 10 | TJC3B-10A-Z | 22.50 | 27.50 | 26.00 | 20 | TJC3B-20A-Z | 47.50 | 52.50 | 51.00 |

| | | | |
|---------------------------------------|--------------|------------------------------------|--|
| GENERAL TOLERANCES (UNLESS SPECIFIED) | | ZHE JIANG DELI CONNECTORS CO., LTD | |
| .X: ± 0.25 | X°: ± 3.0° | PRODUCT NAME: | TITLE: 2.50 mm Pitch Wire To Board Wafer |
| .XX: ± 0.15 | .X°: ± 2.0° | DL25002(TJC3B)-A-Z | |
| .XXX: ± 0.01 | .XX°: ± 1.0° | DR: Yuan Jun Rong | DATE:21/08/01 |
| FINISH: | | CHKD: Wu Hui | DATE:21/08/01 |
| DRAWING NO: | | APPD: Ren An De | DATE:21/08/01 |
| | | PART NO: | SCALE: N/A |
| | | | PAGE: 1/1 |
| | | UNITS: mm | REV.: A |

1

2

3

4

5

6

7

8

| | | | |
|------|----------------------|------|------|
| REV. | REVISION DESCRIPTION | DATE | APPD |
| | | | |

A

B

C

D

E

F

A

B

C

D

E

F

1

2

3

4

5

6

7

8



MARK

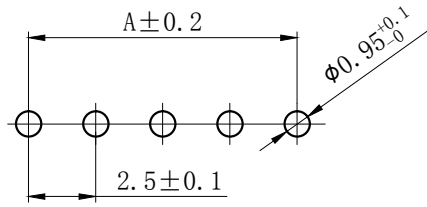
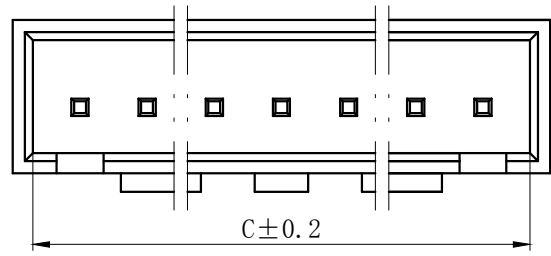
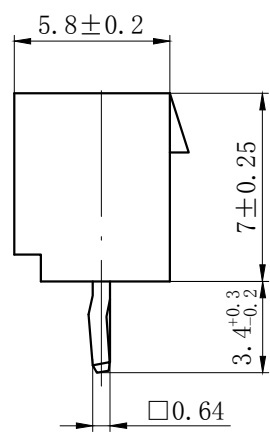
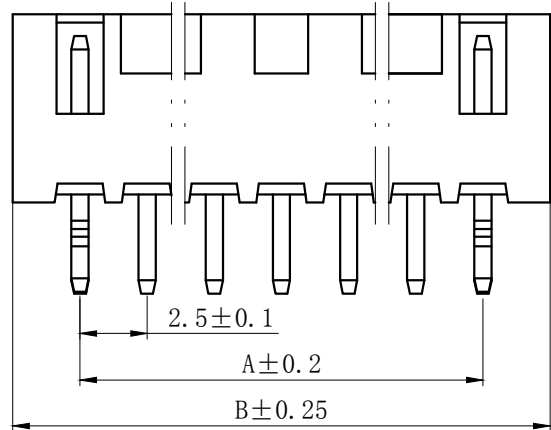
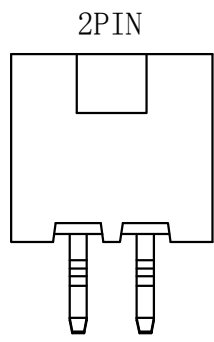
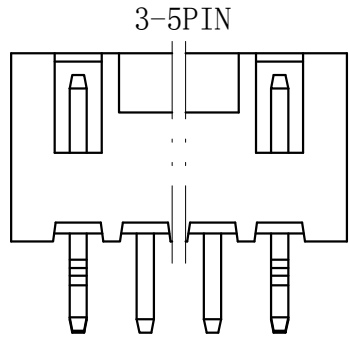

PCB LAYOUT

NOTES

Available in 02 through 20 Circuits.
 Mates with DL25002-Y Series Housing.
 Material : Nylon UL94V-0 (2) .
 0.64mm Square Pin.
 Pin Material : Brass / Tin-Plated.

| Circuits | Product name | Dimension mm | | | Circuits | Product name | Dimension mm | | |
|----------|--------------|--------------|-------|-------|----------|--------------|--------------|-------|-------|
| | | A | B | C | | | A | B | C |
| 2 | TJC3B-2A-K | 2.50 | 7.50 | 5.80 | 11 | TJC3B-11A-K | 25.00 | 30.00 | 28.50 |
| 3 | TJC3B-3A-K | 5.00 | 10.00 | 8.30 | 12 | TJC3B-12A-K | 27.50 | 32.50 | 31.00 |
| 4 | TJC3B-4A-K | 7.50 | 12.50 | 11.00 | 13 | TJC3B-13A-K | 30.00 | 35.00 | 33.50 |
| 5 | TJC3B-5A-K | 10.00 | 15.00 | 13.50 | 14 | TJC3B-14A-K | 32.50 | 37.50 | 36.00 |
| 6 | TJC3B-6A-K | 12.50 | 17.50 | 16.00 | 15 | TJC3B-15A-K | 35.00 | 40.00 | 38.50 |
| 7 | TJC3B-7A-K | 15.00 | 20.00 | 18.50 | 16 | TJC3B-16A-K | 37.50 | 42.50 | 41.00 |
| 8 | TJC3B-8A-K | 17.50 | 22.50 | 21.00 | 17 | TJC3B-17A-K | 40.00 | 45.00 | 43.50 |
| 9 | TJC3B-9A-K | 20.00 | 25.00 | 23.50 | ~ | ~ | ~ | ~ | ~ |
| 10 | TJC3B-10A-K | 22.50 | 27.50 | 26.00 | 20 | TJC3B-20A-K | 47.50 | 52.50 | 51.00 |

| | | | |
|---------------------------------------|--------------|-------------------------------------|--|
| GENERAL TOLERANCES (UNLESS SPECIFIED) | | ZHE JIANG DELI CONNECTORS CO., LTD | |
| .X: ± 0.25 | X°: ± 3.0° | PRODUCT NAME: DL25002(TJC3B)-A-K | TITLE: 2.50 mm Pitch Wire To Board Wafer |
| .XX: ± 0.15 | .X°: ± 2.0° | DR: Yuan Jun Rong | DATE:21/08/01 |
| .XXX: ± 0.01 | .XX°: ± 1.0° | CHKD: Wu Hui | DATE:21/08/01 |
| DRAWING NO: | | APPD: Ren An De | DATE:21/08/01 |
| | | PART NO: | SCALE: N/A |
| | | | PAGE: 1/1 |
| | | UNITS: mm | REV.: A |

1

2

3

4

5

6

7

8

| | | | |
|------|----------------------|------|------|
| REV. | REVISION DESCRIPTION | DATE | APPD |
| | | | |

NOTES

Available in 02 through 20 Circuits.
Mates with DL25002-Y Series Housing.
Material : Nylon UL94V-0 (2) .
0.64mm Square Pin.
Pin Material : Brass / Tin-Plated.

A
B
C
D
E
F

A
B
C
D
E
F

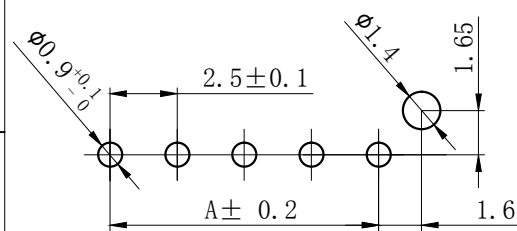
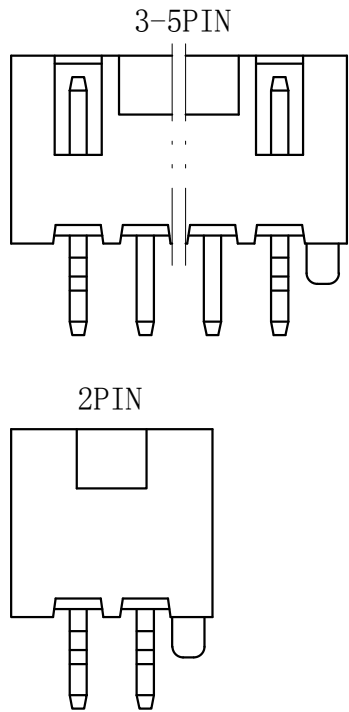
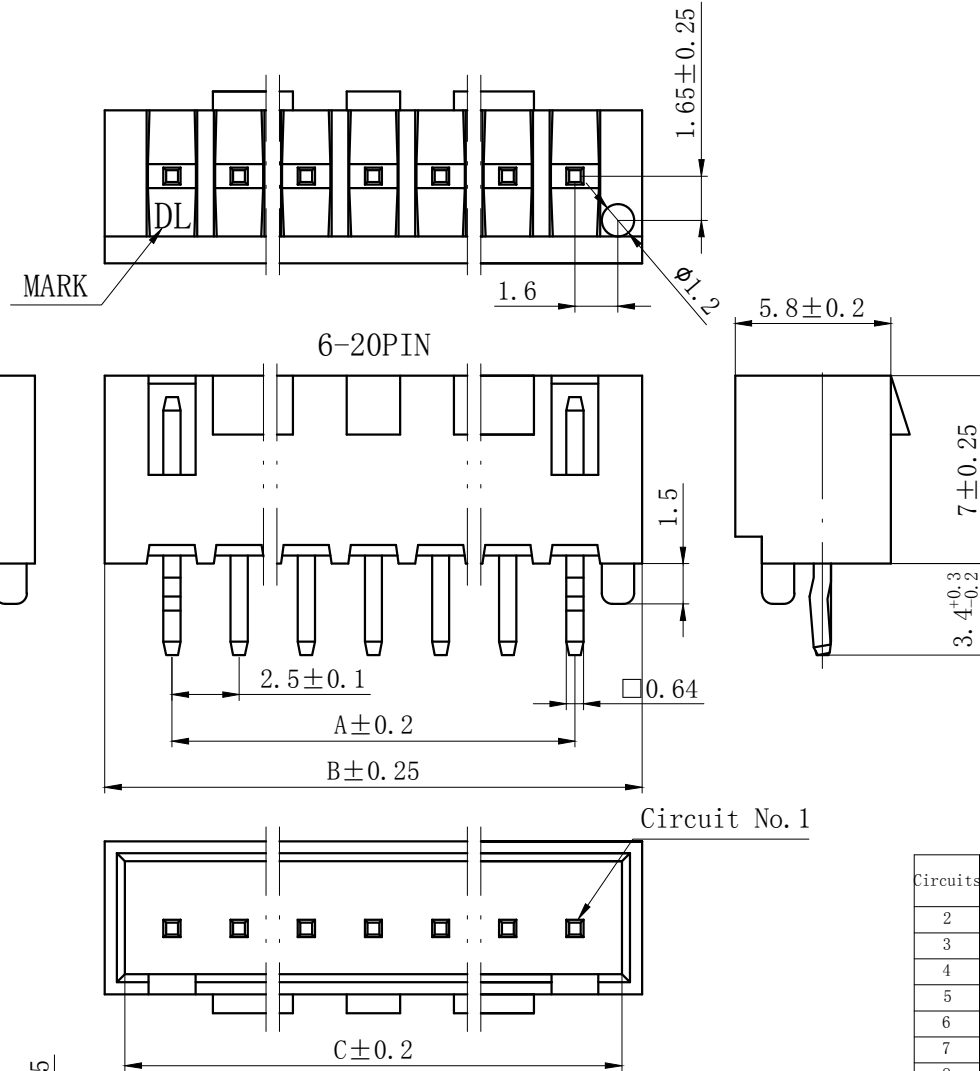

PCB LAYOUT

Circuit No.1

| Circuits | Product name | Dimension mm | | | Circuits | Product name | Dimension mm | | |
|----------|--------------|--------------|-------|-------|----------|--------------|--------------|-------|-------|
| | | A | B | C | | | A | B | C |
| 2 | TJC3B-2AS-K | 2.50 | 7.50 | 5.80 | 11 | TJC3B-11AS-K | 25.00 | 30.00 | 28.50 |
| 3 | TJC3B-3AS-K | 5.00 | 10.00 | 8.30 | 12 | TJC3B-12AS-K | 27.50 | 32.50 | 31.00 |
| 4 | TJC3B-4AS-K | 7.50 | 12.50 | 11.00 | 13 | TJC3B-13AS-K | 30.00 | 35.00 | 33.50 |
| 5 | TJC3B-5AS-K | 10.00 | 15.00 | 13.50 | 14 | TJC3B-14AS-K | 32.50 | 37.50 | 36.00 |
| 6 | TJC3B-6AS-K | 12.50 | 17.50 | 16.00 | 15 | TJC3B-15AS-K | 35.00 | 40.00 | 38.50 |
| 7 | TJC3B-7AS-K | 15.00 | 20.00 | 18.50 | 16 | TJC3B-16AS-K | 37.50 | 42.50 | 41.00 |
| 8 | TJC3B-8AS-K | 17.50 | 22.50 | 21.00 | 17 | TJC3B-17AS-K | 40.00 | 45.00 | 43.50 |
| 9 | TJC3B-9AS-K | 20.00 | 25.00 | 23.50 | ~ | ~ | ~ | ~ | ~ |
| 10 | TJC3B-10AS-K | 22.50 | 27.50 | 26.00 | 20 | TJC3B-20AS-K | 47.50 | 52.50 | 51.00 |

| | | | |
|---------------------------------------|--------------|--------------------------------------|--|
| GENERAL TOLERANCES (UNLESS SPECIFIED) | | ZHE JIANG DELI CONNECTORS CO., LTD | |
| .X: ± 0.25 | X°: ± 3.0° | PRODUCT NAME: DL25002(TJC3B)-AS-K | TITLE: 2.50 mm Pitch Wire To Board Wafer |
| .XX: ± 0.15 | .X°: ± 2.0° | DR: Yuan Jun Rong | DATE:21/08/01 |
| .XXX: ± 0.01 | .XX°: ± 1.0° | CHKD: Wu Hui | DATE:21/08/01 |
| DRAWING NO: | | APPD: Ren An De | DATE:21/08/01 |
| | | PART NO: | |
| | | SCALE: N/A | PAGE: 1/1 |
| | | UNITS: mm | REV.: A |

1 2 3 4 5 6 7 8

| | | | |
|------|----------------------|------|------|
| REV. | REVISION DESCRIPTION | DATE | APPD |
| | | | |

NOTES

Available in 02 through 20 Circuits.
 Mates with DL25002-Y Series Housing.
 Material : Nylon UL94V-0 (2) .
 0.64mm Square Pin.
 Pin Material : Brass / Tin-Plated.

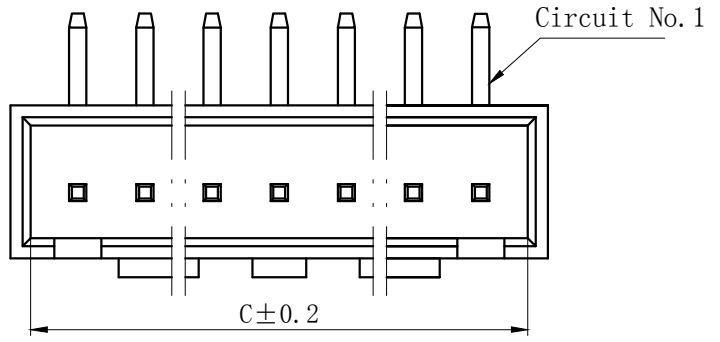
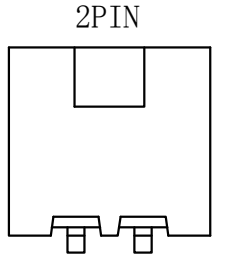
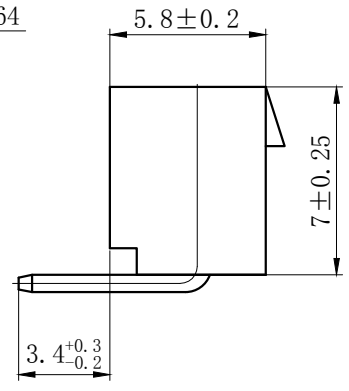
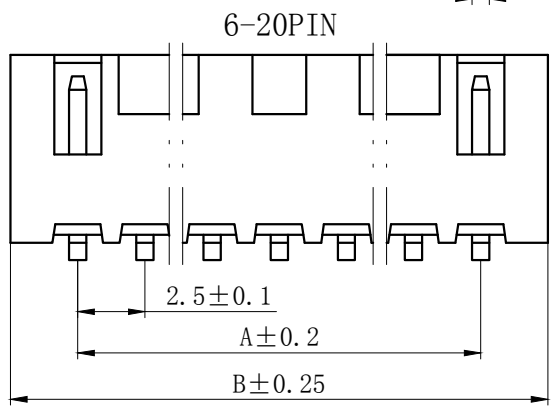
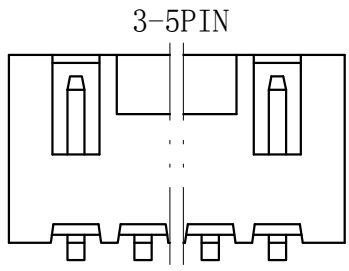

| Circuits | Product name | Dimension mm | | | Circuits | Product name | Dimension mm | | |
|----------|--------------|--------------|-------|-------|----------|--------------|--------------|-------|-------|
| | | A | B | C | | | A | B | C |
| 2 | TJC3B-2AW-Z | 2.50 | 7.50 | 5.80 | 11 | TJC3B-11AW-Z | 25.00 | 30.00 | 28.50 |
| 3 | TJC3B-3AW-Z | 5.00 | 10.00 | 8.30 | 12 | TJC3B-12AW-Z | 27.50 | 32.50 | 31.00 |
| 4 | TJC3B-4AW-Z | 7.50 | 12.50 | 11.00 | 13 | TJC3B-13AW-Z | 30.00 | 35.00 | 33.50 |
| 5 | TJC3B-5AW-Z | 10.00 | 15.00 | 13.50 | 14 | TJC3B-14AW-Z | 32.50 | 37.50 | 36.00 |
| 6 | TJC3B-6AW-Z | 12.50 | 17.50 | 16.00 | 15 | TJC3B-15AW-Z | 35.00 | 40.00 | 38.50 |
| 7 | TJC3B-7AW-Z | 15.00 | 20.00 | 18.50 | 16 | TJC3B-16AW-Z | 37.50 | 42.50 | 41.00 |
| 8 | TJC3B-8AW-Z | 17.50 | 22.50 | 21.00 | 17 | TJC3B-17AW-Z | 40.00 | 45.00 | 43.50 |
| 9 | TJC3B-9AW-Z | 20.00 | 25.00 | 23.50 | ~ | ~ | ~ | ~ | ~ |
| 10 | TJC3B-10AW-Z | 22.50 | 27.50 | 26.00 | 20 | TJC3B-20AW-Z | 47.50 | 52.50 | 51.00 |

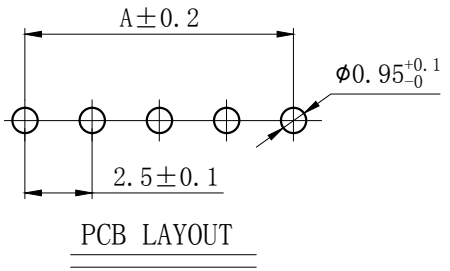

| | | | |
|---------------------------------------|--------------|--------------------------------------|--|
| GENERAL TOLERANCES (UNLESS SPECIFIED) | | ZHE JIANG DELI CONNECTORS CO., LTD | |
| .X: ± 0.25 | X°: ± 3.0° | PRODUCT NAME: DL25002(TJC3B)-AW-Z | TITLE: 2.50 mm Pitch Wire To Board Wafer |
| .XX: ± 0.15 | .X°: ± 2.0° | DR: Yuan Jun Rong | DATE:21/08/01 |
| .XXX: ± 0.01 | .XX°: ± 1.0° | CHKD: Wu Hui | DATE:21/08/01 |
| DRAWING NO: | | APPD: Ren An De | DATE:21/08/01 |
| | | PART NO: | SCALE: N/A |
| | | | PAGE: 1/1 |
| | | UNITS: mm | REV.: A |

| | | | |
|------|----------------------|------|------|
| REV. | REVISION DESCRIPTION | DATE | APPD |
| | | | |

NOTES

Available in 02 through 20 Circuits.
Mates with DL25002-Y Series Housing.
Material : Nylon UL94V-0 (2) .
0.64mm Square Pin.
Pin Material : Brass / Tin-Plated.

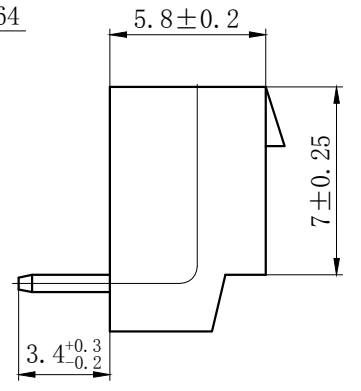

| Circuits | Type | Dimension mm | | | Circuits | Type | Dimension mm | | |
|----------|-------------|--------------|-------|-------|----------|-------------|--------------|-------|-------|
| | | A | B | C | | | A | B | C |
| 2 | TJC3B-2AWD | 2.50 | 7.50 | 5.80 | 11 | TJC3B-11AWD | 25.00 | 30.00 | 28.50 |
| 3 | TJC3B-3AWD | 5.00 | 10.00 | 8.30 | 12 | TJC3B-12AWD | 27.50 | 32.50 | 31.00 |
| 4 | TJC3B-4AWD | 7.50 | 12.50 | 11.00 | 13 | TJC3B-13AWD | 30.00 | 35.00 | 33.50 |
| 5 | TJC3B-5AWD | 10.00 | 15.00 | 13.50 | 14 | TJC3B-14AWD | 32.50 | 37.50 | 36.00 |
| 6 | TJC3B-6AWD | 12.50 | 17.50 | 16.00 | 15 | TJC3B-15AWD | 35.00 | 40.00 | 38.50 |
| 7 | TJC3B-7AWD | 15.00 | 20.00 | 18.50 | 16 | TJC3B-16AWD | 37.50 | 42.50 | 41.00 |
| 8 | TJC3B-8AWD | 17.50 | 22.50 | 21.00 | 17 | TJC3B-17AWD | 40.00 | 45.00 | 43.50 |
| 9 | TJC3B-9AWD | 20.00 | 25.00 | 23.50 | ~ | ~ | ~ | ~ | ~ |
| 10 | TJC3B-10AWD | 22.50 | 27.50 | 26.00 | 20 | TJC3B-20AWD | 47.50 | 52.50 | 51.00 |



| | | | |
|--|--------------|---|--|
| GENERAL TOLERANCES (UNLESS SPECIFIED) | | ZHE JIANG DELI CONNECTORS CO., LTD | |
| .X: ± 0.25 | X°: ± 3.0° | PRODUCT NAME: DL25002 (TJC3B)-AWD | TITLE: 2.50 mm Pitch Wire To Board Wafer |
| .XX: ± 0.15 | .X°: ± 2.0° | DR: Yuan Jun Rong | DATE: 21/08/01 |
| .XXX: ± 0.01 | .XX°: ± 1.0° | CHKD: Wu Hui | DATE: 21/08/01 |
| DRAWING NO: | | APPD: Ren An De | DATE: 21/08/01 |
| FINISH: | | PART NO: | |
| SCALE: N/A | | PAGE: 1/1 | |
| UNITS: mm | | REV.: A | |

| REV. | REVISION DESCRIPTION | DATE | APPD |
|------|----------------------|------|------|
| | | | |

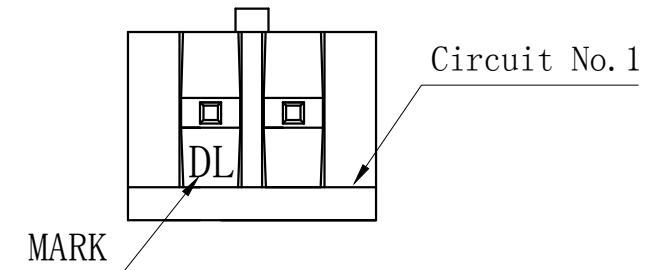

NOTES

Available in 02 Circuits.
 Mates with DL25002-Y Series Housing.
 Material : Nylon UL94V-0 (2) .
 0.64mm Square Pin.
 Pin Material : Brass / Tin-Plated.

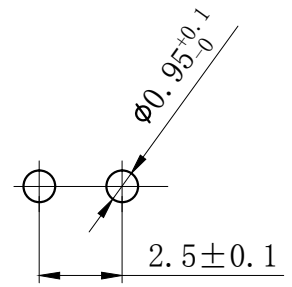
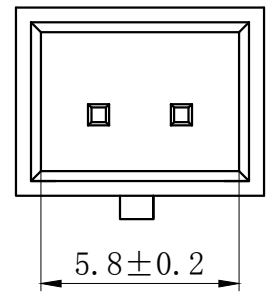
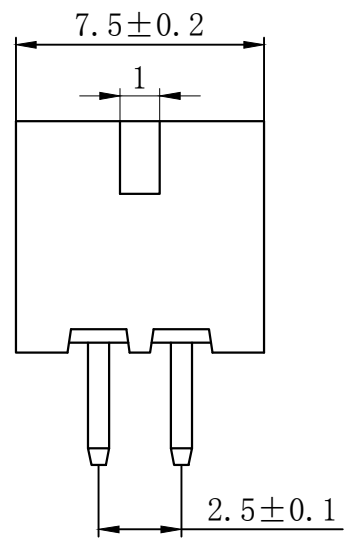

PCB LAYOUT

| GENERAL TOLERANCES (UNLESS SPECIFIED) | | ZHE JIANG DELI CONNECTORS CO., LTD | |
|---------------------------------------|---------------|------------------------------------|--|
| .X: ± 0.25 | X° : ± 3.0° | PRODUCT NAME: | TITLE: 2.50 mm Pitch Wire To Board Wafer |
| .XX: ± 0.15 | .X° : ± 2.0° | DL25002 (TJC3B)-2AJ-Z | |
| .XXX: ± 0.01 | .XX° : ± 1.0° | DR: Yuan Jun Rong | DATE: 21/08/01 |
| FINISH: | | CHKD: Wu Hui | DATE: 21/08/01 |
| DRAWING NO: | | APPD: Ren An De | DATE: 21/08/01 |
| | | SCALE: N/A | PAGE: 1/1 |
| | | UNITS: mm | REV.: A |

| | | | |
|------|----------------------|------|------|
| REV. | REVISION DESCRIPTION | DATE | APPD |
| | | | |

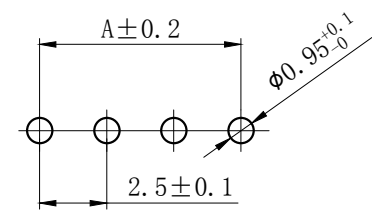
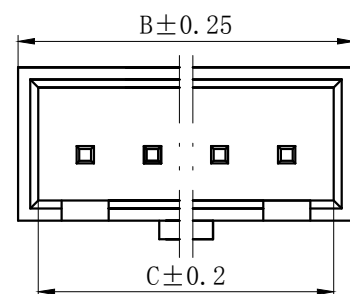
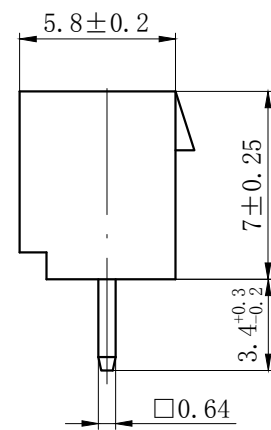
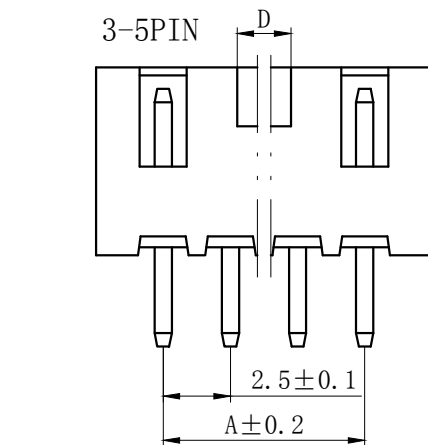
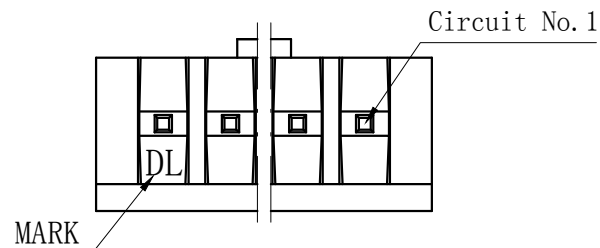

PCB LAYOUT

NOTES

Available in 02 through 05 Circuits.
Mates with DL25002-Y Series Housing.
Material : Nylon UL94V-0 (2) .
0.64mm Square Pin.
Pin Material : Brass / Tin-Plated.

| Circuits | Type | Dimension mm | | | |
|----------|-------------|--------------|-------|-------|------|
| | | A | B | C | D |
| 3 | TJC3B-3AJ-Z | 5.00 | 10.00 | 8.30 | 1.00 |
| 4 | TJC3B-4AJ-Z | 7.50 | 12.50 | 11.00 | 2.00 |
| 5 | TJC3B-5AJ-Z | 10.00 | 15.00 | 13.50 | 2.20 |

| | | | |
|---------------------------------------|--------------|--------------------------------------|--|
| GENERAL TOLERANCES (UNLESS SPECIFIED) | | ZHE JIANG DELI CONNECTORS CO., LTD | |
| .X: ± 0.25 | X°: ± 3.0° | PRODUCT NAME: DL25002(TJC3B)-AJ-Z | TITLE: 2.50 mm Pitch Wire To Board Wafer |
| .XX: ± 0.15 | .X°: ± 2.0° | DR: Yuan Jun Rong | DATE:21/08/01 |
| .XXX: ± 0.01 | .XX°: ± 1.0° | DATE:21/08/01 | PART NO: |
| FINISH: | | CHKD: Wu Hui | DATE:21/08/01 |
| DRAWING NO: | | APPD: Ren An De | DATE:21/08/01 |
| | | | SCALE: N/A |
| | | | PAGE: 1/1 |
| | | | UNITS: mm |
| | | | REV.: A |

| REV. | REVISION DESCRIPTION | DATE | APPD |
|------|----------------------|------|------|
| | | | |



NOTES

Available in 02 Circuits.

Mates with DL25002-Y Series Housing.

Material : Nylon UL94V-0 (2) .

0.64mm Square Pin.

Pin Material : Brass / Tin-Plated.



PCB LAYOUT

| GENERAL TOLERANCES (UNLESS SPECIFIED) | | ZHE JIANG DELI CONNECTORS CO., LTD | |
|---------------------------------------|---------------|------------------------------------|--|
| .X: ± 0.25 | X° : ± 3.0° | PRODUCT NAME: | TITLE: 2.50 mm Pitch Wire To Board Wafer |
| .XX: ± 0.15 | .X° : ± 2.0° | DL25002 (TJC3B)-2AJ-KC | |
| .XXX: ± 0.01 | .XX° : ± 1.0° | DR: Yuan Jun Rong | DATE: 21/08/01 |
| FINISH: | | CHKD: Wu Hui | DATE: 21/08/01 |
| DRAWING NO: | | APPD: Ren An De | DATE: 21/08/01 |
| | | SCALE: N/A | PAGE: 1/1 |
| | | UNITS: mm | REV.: A |

| | | | |
|------|----------------------|------|------|
| REV. | REVISION DESCRIPTION | DATE | APPD |
| | | | |

NOTES

Available in 02 through 20 Circuits.
 Match with DL25002-Y series housing
 Material : Nylon UL94V-0(2).
 Accepts DL25002-RT Crimp Terminal.



| Circuits | Product name | Dimension mm | | | Circuits | Product name | Dimension mm | | |
|----------|--------------|--------------|-------|-------|----------|--------------|--------------|-------|-------|
| | | A | B | C | | | A | B | C |
| 2 | TJC3B-2R | 2.50 | 7.50 | 6.00 | 10 | TJC3B-10R | 22.50 | 27.50 | 26.00 |
| 3 | TJC3B-3R | 5.00 | 10.00 | 8.50 | 11 | TJC3B-11R | 25.00 | 30.00 | 28.50 |
| 4 | TJC3B-4R | 7.50 | 12.50 | 11.00 | 12 | TJC3B-12R | 27.50 | 32.50 | 31.00 |
| 5 | TJC3B-5R | 10.00 | 15.00 | 13.50 | 13 | TJC3B-13R | 30.00 | 35.00 | 33.50 |
| 6 | TJC3B-6R | 12.50 | 17.50 | 16.00 | 14 | TJC3B-14R | 32.50 | 37.50 | 36.00 |
| 7 | TJC3B-7R | 15.00 | 20.00 | 18.50 | 15 | TJC3B-15R | 35.00 | 40.00 | 38.50 |
| 8 | TJC3B-8R | 17.50 | 22.50 | 21.00 | - | - | - | - | - |
| 9 | TJC3B-9R | 20.00 | 25.00 | 23.50 | 20 | TJC3B-20R | 47.50 | 52.50 | 51.00 |

| | | | | | |
|--|--------------|------------------------------------|---------------|---|------------|
| GENERAL TOLERANCES (UNLESS SPECIFIED) | | ZHE JIANG DELI CONNECTORS CO., LTD | | | |
| .X: ± 0.25 | X°: ± 3.0° | PRODUCT NAME: DL25002(TJC3B)-R | | TITLE: 2.50 mm Pitch Wire To Wire Housing | |
| .XX: ± 0.15 | .X°: ± 2.0° | DR:Chen Quan Long | | DATE:20/12/30 | |
| .XXX: ± 0.01 | .XX°: ± 1.0° | FINISH: | | PART NO: | |
| DRAWING NO: | | CHKD: Wu Hui | DATE:20/12/30 | | SCALE: N/A |
| | | APPD:Ren An De | DATE:20/12/30 | | PAGE: 1/1 |
| | | UNITS: mm | | REV.: A | |

| | | | | | |
|------|---|----------------------|---|------|------|
| REV. | 7 | REVISION DESCRIPTION | 8 | DATE | APPD |
| | | | | | |

NOTES

Available in 02 through 20 Circuits.
 Match with DL25002 series housing
 Material : Nylon UL94V-0(2).
 Accepts DL25002-T Crimp Terminal.

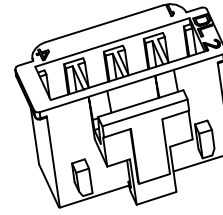
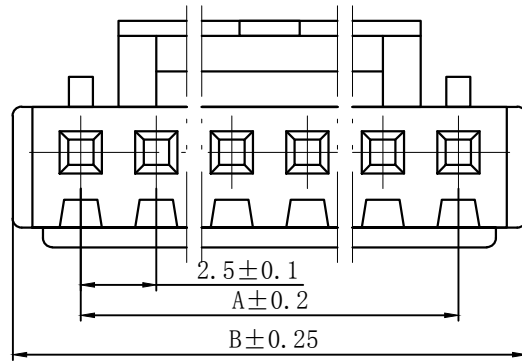

C3B-2Y



| Circuits | Product name | Dimension mm | | | | Circuits | Product name | Dimension mm | | | |
|----------|--------------|--------------|-------|-------|-------|----------|--------------|--------------|-------|-------|------|
| | | A | B | C | D | | | A | B | C | D |
| 2 | TJC3B-2Y | 2.50 | 7.00 | 5.70 | 5.30 | 12 | TJC3B-12Y | 27.50 | 32.00 | 30.70 | 15.1 |
| 3 | TJC3B-3Y | 5.00 | 9.50 | 8.20 | 5.10 | 13 | TJC3B-13Y | 30.00 | 34.50 | 33.20 | 15.1 |
| 4 | TJC3B-4Y | 7.50 | 12.00 | 10.70 | 5.10 | 14 | TJC3B-14Y | 32.50 | 37.00 | 35.70 | 15.1 |
| 5 | TJC3B-5Y | 10.00 | 14.50 | 13.20 | 7.60 | 15 | TJC3B-15Y | 35.00 | 39.50 | 38.20 | 15.1 |
| 6 | TJC3B-6Y | 12.50 | 17.00 | 15.70 | 10.10 | 16 | TJC3B-16Y | 37.50 | 42.00 | 40.70 | 15.1 |
| 7 | TJC3B-7Y | 15.00 | 19.50 | 18.20 | 12.60 | 17 | TJC3B-17Y | 40.00 | 44.50 | 43.20 | 15.1 |
| 8 | TJC3B-8Y | 17.50 | 22.00 | 20.70 | 15.10 | 18 | TJC3B-18Y | 42.50 | 47.00 | 45.70 | 15.1 |
| 9 | TJC3B-9Y | 20.00 | 24.50 | 23.20 | 17.60 | 19 | TJC3B-19Y | 45.00 | 49.50 | 48.20 | 15.1 |
| 10 | TJC3B-10Y | 22.50 | 27.00 | 25.70 | 15.10 | 20 | TJC3B-20Y | 47.50 | 52.00 | 50.70 | 15.1 |
| 11 | TJC3B-11Y | 25.00 | 29.50 | 28.20 | 15.10 | | | | | | |

| | | | | | |
|--|--------------|------------------------------------|----------------|---------------------------------|-----------|
| GENERAL TOLERANCES (UNLESS SPECIFIED) | | ZHE JIANG DELI CONNECTORS CO., LTD | | | |
| .X: ± 0.25 | X°: ± 3.0° | PRODUCT NAME: DL25002 (TJC3B)-Y | | TITLE: 2.50 mm Pitch Housing | |
| .XX: ± 0.15 | .X°: ± 2.0° | DR: Yuan Jun Rong | DATE: 21/03/18 | PART NO: | |
| .XXX: ± 0.01 | .XX°: ± 1.0° | CHKD: Wu Hui | DATE: 21/03/18 | SCALE: N/A | PAGE: 1/1 |
| DRAWING NO: | | APPD: Ren An De | DATE: 21/03/18 | UNITS: mm | REV.: A |

| | | | |
|------|----------------------|------|------|
| REV. | REVISION DESCRIPTION | DATE | APPD |
| | | | |

NOTES

Available in 02 through 20 Circuits.
 Match with DL25001-Y series housing
 Material : Nylon UL94V-0(2).

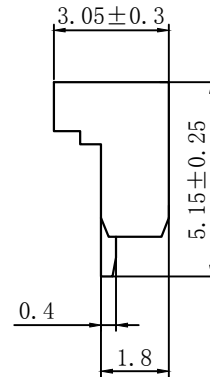

| Circuits | Product name | Dimension mm | | Circuits | Product name | Dimension mm | |
|----------|--------------|--------------|------|----------|--------------|--------------|------|
| | | A | B | | | A | B |
| 2 | TJC3-2S | 2.50 | 8.7 | 9 | TJC3-9S | 20.00 | 26.2 |
| 3 | TJC3-3S | 5.00 | 11.2 | 10 | TJC3-10S | 22.50 | 28.7 |
| 4 | TJC3-4S | 7.50 | 13.7 | 11 | TJC3-11S | 25.00 | 31.2 |
| 5 | TJC3-5S | 10.00 | 16.2 | 12 | TJC3-12S | 27.50 | 33.7 |
| 6 | TJC3-6S | 12.50 | 18.7 | 13 | TJC3-13S | 30.00 | 36.2 |
| 7 | TJC3-7S | 15.00 | 21.2 | ~ | ~ | ~ | ~ |
| 8 | TJC3-8S | 17.50 | 23.7 | 20 | TJC3-20S | 47.80 | 53.7 |

| | | | | | |
|--|--------------|------------------------------------|---------------|---------------------------------|-----------|
| GENERAL TOLERANCES (UNLESS SPECIFIED) | | ZHE JIANG DELI CONNECTORS CO., LTD | | | |
| .X: ± 0.25 | X°: ± 3.0° | PRODUCT NAME: DL25001(TJC3)-S | | TITLE: 2.50 mm Pitch Housing | |
| .XX: ± 0.15 | .X°: ± 2.0° | DR: Yuan Jun Rong | DATE:21/03/18 | PART NO: | |
| .XXX: ± 0.01 | .XX°: ± 1.0° | CHKD: Wu Hui | DATE:21/03/18 | SCALE: N/A | PAGE: 1/1 |
| FINISH: | | APPD: Ren An De | DATE:21/03/18 | UNITS: mm | REV.: A |
| DRAWING NO: | | | | | |

| REV. | REVISION DESCRIPTION | DATE | APPD |
|------|----------------------|------|------|
| | | | |



NOTES

Used in DL25001-Y Series Housing.
 Accepts AWG #28~22 Wire Range.
 0.08~ 0.33 mm² .
 Insulation O.D.=1.2~1.9 mm.
 Material : Phosphor Bronze .
 Finish: Tin plated.
 Thickness: 0.2 mm.



SECTION A-A



SECTION B-B



SECTION C-C

| GENERAL TOLERANCES (UNLESS SPECIFIED) | | ZHE JIANG DELI CONNECTORS CO., LTD | |
|--|---------------|--|---|
| .X: ± 0.25 | X° : ± 3.0° | PRODUCT NAME: DL25001 (TJC3)-T | TITLE: 2.50 mm Pitch Crimp Terminal |
| .XX: ± 0.15 | .X° : ± 2.0° | DR: Chen Quan Long | DATE: 19/08/01 |
| .XXX: ± 0.01 | .XX° : ± 1.0° | CHKD: Wu Hui | DATE: 19/08/01 |
| FINISH: | | APPD: Ren An De | DATE: 19/08/01 |
| DRAWING NO: | | | |
| | | SCALE: N/A | PAGE: 1/1 |
| | | UNITS: mm | REV.: A |

| REV. | REVISION DESCRIPTION | DATE | APPD |
|------|----------------------|------|------|
| | | | |



NOTES

Used in DL25001-Y Series Housing.
 Accepts AWG #24~20 Wire Range.
 Material : Phosphor Bronze .
 Finish: Tin plated.
 Thickness: 0.2 mm.

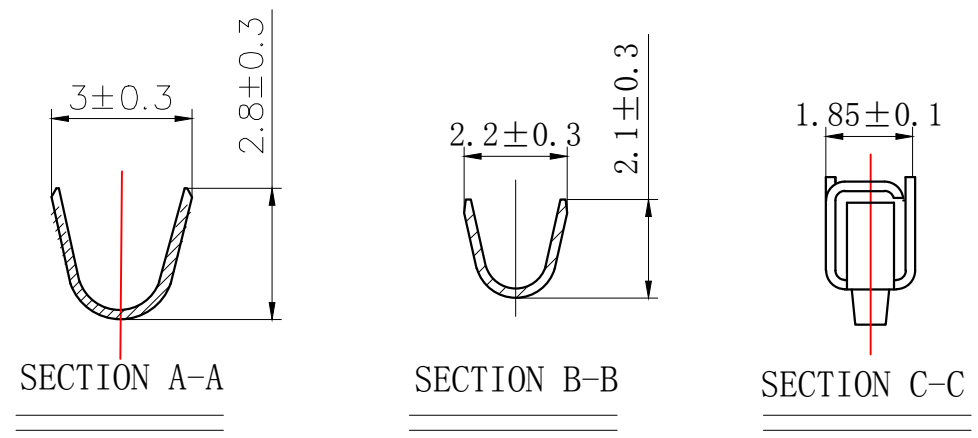

| GENERAL TOLERANCES (UNLESS SPECIFIED) | | | | ZHE JIANG DELI CONNECTORS CO., LTD | | | |
|--|--------------|---|----------------|---|--|-----------|--|
| .X: ± 0.25 | X°: ± 3.0° | PRODUCT NAME: DL25001(TJC3)-T-G | | TITLE: 2.50 mm Pitch Crimp Terminal | | PART NO: | |
| .XX: ± 0.15 | .X°: ± 2.0° | DR: Chen Quan Long | DATE: 19/08/01 | SCALE: N/A | | PAGE: 1/1 | |
| .XXX: ± 0.01 | .XX°: ± 1.0° | CHKD: Wu Hui | DATE: 19/08/01 | UNITS: mm | | REV.: A | |
| DRAWING NO: | | APPD: Ren An De | DATE: 19/08/01 | | | | |

| REV. | REVISION DESCRIPTION | DATE | APPD |
|------|----------------------|------|------|
| | | | |

NOTES

Used in DL25002-R Series Housing.
Accepts AWG #28~22 Wire Range.

0.08~ 0.33 mm² .

Insulation O.D. =1.2~1.9 mm.

Material : Phosphor Bronze .

Finish: Tin plated.

Thickness: 0.2 mm.

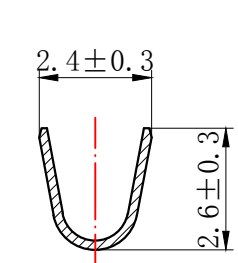

SECTION A-A



SECTION B-B



SECTION C-C

| GENERAL TOLERANCES (UNLESS SPECIFIED) | | | | ZHE JIANG DELI CONNECTORS CO., LTD | | | |
|---------------------------------------|--------------|-------------------------------------|----------------|--|-----------|--|--|
| .X: ± 0.25 | X°: ± 3.0° | PRODUCT NAME: DL25002 (TJC3B)-RT | | TITLE: 2.50 mm Pitch Wire To Wire Terminal | | | |
| .XX: ± 0.15 | .X°: ± 2.0° | DR: Chen Quan Long | DATE: 20/12/30 | PART NO: | | | |
| .XXX: ± 0.01 | .XX°: ± 1.0° | CHKD: Wu Hui | DATE: 20/12/30 | SCALE: N/A | PAGE: 1/1 | | |
| DRAWING NO: | | APPD: Ren An De | DATE: 20/12/30 | UNITS: mm | REV.: A | | |

X-ON Electronics

Largest Supplier of Electrical and Electronic Components

Click to view similar products for [Headers & Wire Housings](#) category:

Click to view products by [DLL](#) manufacturer:

Other Similar products are found below :

[0015917161](#) [0022155065](#) [57102-F02-18ULF](#) [58102-G61-06LF](#) [582553-1](#) [01.001.5753.1](#) [0050291907](#) [02.125.8002.8](#) [609-3404](#) [61062-3](#)
[CSU011177004](#) [622-0430](#) [622-3653LF](#) [63453-116](#) [636-1030](#) [636-1427](#) [636-3427](#) [636-4007](#) [641938-9](#) [65495-038](#) [65692-001LF](#) [65781-018](#)
[65781-047](#) [65817-010LF](#) [65817-015LF](#) [67095-007LF](#) [67601157](#) [68631-112](#) [68645-018](#) [699319-000](#) [70.362.1628.0](#) [70-4210](#) [70-4226B](#) [70-](#)
[4853B](#) [71.350.2428.0](#) [733-134](#) [733-162](#) [760-3052](#) [MHR-64-VUAL](#) [80.063.4001.1](#) [800-90-001-10-001000](#) [801-43-002-10-013000](#)
[801-43-006-10-002000](#) [803-43-024-10-001000](#) [803-93-012-10-001000](#) [8-1437020-4](#) [819-22-004-30-001101](#) [820-22-006-30-001101](#)
[820-22-008-30-001101](#) [821-22-002-10-001101](#)