



技术特性/Specifications:

额定电压 Rated voltage: 250V AC, DC
额定电流 Rated current: 3A AC, DC
接触电阻 Contact resistance: 20m Ω max
绝缘电阻 Insulation resistance: 1000M Ω min
耐压 Withstand voltage: 1000V AC/minute
环境温度 Ambient temperature: -40 $^{\circ}$ C~+105 $^{\circ}$ C
适用线规 Wire range: AWG#28~#20

REV.	REVISION DESCRIPTION	DATE	
B	更新外观结构	19. 5. 29	Wu

A

B

C

D

E

F

A

B

C

D

E

F

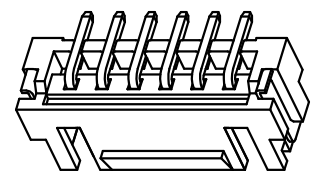
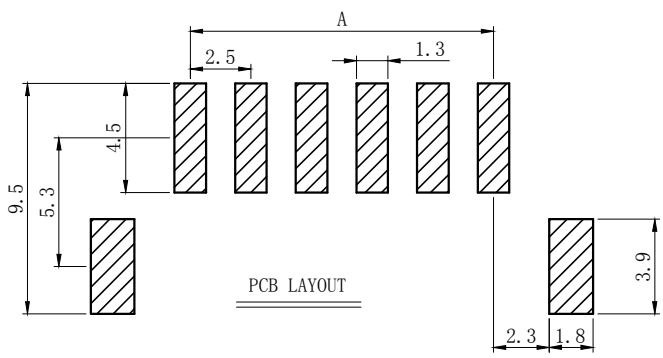
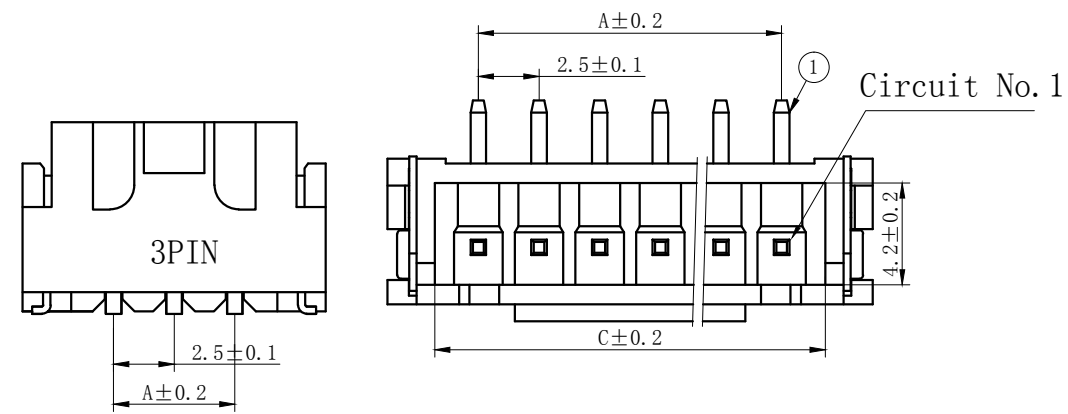
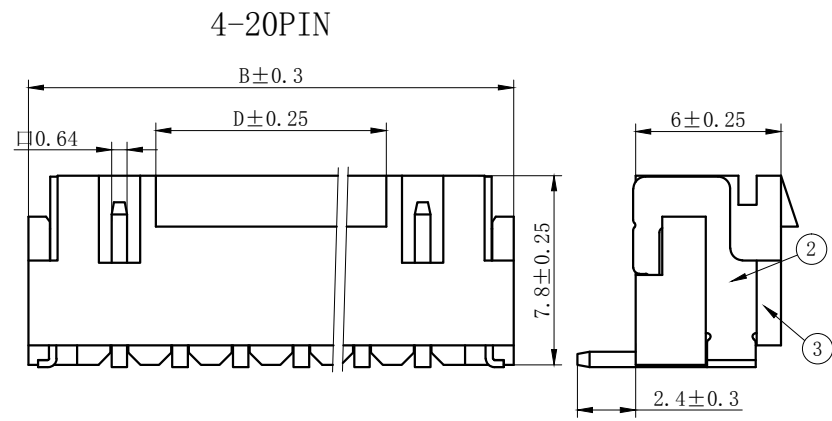
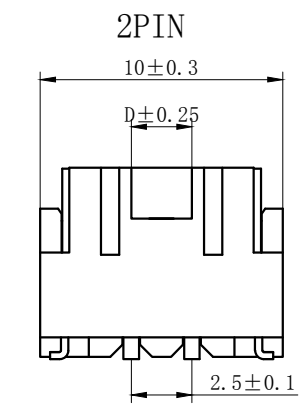

NOTES

Available in 02 through 20 Circuits.
 Mates with DL25002-Y Series Housing.
 Material : LCP UL94V-0.
 Pin Material : Brass.Tin-plated .

3	③	基座	LCP	1	UL94V-0
2	②	焊片	黄铜	2	镀锡
1	①	接触件	黄铜	N*	镀锡
序号	图号	名称	材料	数量	附件

Type	Product name	Dimension mm				Type	Product name	Dimension mm			
		A	B	C	D			A	B	C	D
2	TJC3B-2AB	2.50	10.00	5.95	2.50	12	TJC3B-12AB	27.50	35.00	30.95	24.50
3	TJC3B-3AB	5.00	12.50	8.45	2.50	13	TJC3B-13AB	30.00	37.50	33.45	27.00
4	TJC3B-4AB	7.50	15.00	10.95	4.50	14	TJC3B-14AB	32.50	40.00	35.95	29.50
5	TJC3B-5AB	10.00	17.50	13.45	7.00	15	TJC3B-15AB	35.00	42.50	38.45	32.00
6	TJC3B-6AB	12.50	20.00	15.95	9.50	16	TJC3B-16AB	37.50	45.00	40.95	34.50
7	TJC3B-7AB	15.00	22.50	18.45	12.00	17	TJC3B-17AB	40.00	47.50	43.45	37.00
8	TJC3B-8AB	17.50	25.00	20.95	14.50	18	TJC3B-18AB	42.50	50.00	45.95	39.50
9	TJC3B-9AB	20.00	27.50	23.45	17.00	19	TJC3B-19AB	45.00	52.50	48.45	42.00
10	TJC3B-10AB	22.50	30.00	25.95	19.50	20	TJC3B-20AB	47.50	55.00	50.95	44.50
11	TJC3B-11AB	25.00	32.50	28.45	22.00						

GENERAL TOLERANCES (UNLESS SPECIFIED)		ZHE JIANG DELI CONNECTORS CO., LTD			
.X: ± 0.25	X°: ± 3.0°	PRODUCT NAME: DL25002 (TJC3B)-AB		TITLE: 2.50 mm Pitch Wire To Board SMT Wafer	
.XX: ± 0.15	.X°: ± 2.0°	DR: Wang Li Te		DATE: 18/03/07	
.XXX: ± 0.01	.XX°: ± 1.0°	FINISH:		PART NO:	
DRAWING NO:		CHKD: ZhangTing		DATE: 18/03/07	
		APPD: Wu Hui		DATE: 18/03/07	
		SCALE: N/A		PAGE: 1/1	
		UNITS: mm		REV.: B	

REV.	REVISION DESCRIPTION	DATE	APPD
B	自动包装检测需要优化外观	19.4.2	WU

NOTES

Available in 02 through 20 Circuits.
 Mates with DL25002-Y Series Housing.
 Material : LCP UL94V-0.
 Pin Material : Brass.Tin-plated .

3	③	基座	LCP	1	UL94V-0
2	②	焊片	黄铜	2	镀锡
1	①	接触件	黄铜	N*	镀锡
序号	图号	名称	材料	数量	附件

Type	Product name	Dimension mm				Type	Product name	Dimension mm			
		A	B	C	D			A	B	C	D
2	TJC3B-2AWB	2.50	10.00	5.95	2.50	12	TJC3B-12AWB	27.50	35.00	30.95	24.50
3	TJC3B-3AWB	5.00	12.50	8.45	2.50	13	TJC3B-13AWB	30.00	37.50	33.45	27.00
4	TJC3B-4AWB	7.50	15.00	10.95	4.50	14	TJC3B-14AWB	32.50	40.00	35.95	29.50
5	TJC3B-5AWB	10.00	17.50	13.45	7.00	15	TJC3B-15AWB	35.00	42.50	38.45	32.00
6	TJC3B-6AWB	12.50	20.00	15.95	9.50	16	TJC3B-16AWB	37.50	45.00	40.95	34.50
7	TJC3B-7AWB	15.00	22.50	18.45	12.00	17	TJC3B-17AWB	40.00	47.50	43.45	37.00
8	TJC3B-8AWB	17.50	25.00	20.95	14.50	18	TJC3B-18AWB	42.50	50.00	45.95	39.50
9	TJC3B-9AWB	20.00	27.50	23.45	17.00	19	TJC3B-19AWB	45.00	52.50	48.45	42.00
10	TJC3B-10AWB	22.50	30.00	25.95	19.50	20	TJC3B-20AWB	47.50	55.00	50.95	44.50
11	TJC3B-11AWB	25.00	32.50	28.45	22.00						

GENERAL TOLERANCES (UNLESS SPECIFIED)		ZHE JIANG DELI CONNECTORS CO.,LTD	
.X: ± 0.25	X°: ± 3.0°	PRODUCT NAME:	TITLE: 2.50 mm Pitch Wire To Board SMT Wafer
.XX: ± 0.15	.X°: ± 2.0°	DL25002(TJC3B)-AWB	PART NO:
.XXX: ± 0.01	.XX°: ± 1.0°	DR:Yuan Jun Rong	DATE:21/03/03
FINISH:		CHKD:Wu Hui	DATE:21/03/03
DRAWING NO:		APPD:Ren An De	DATE:21/03/03
		SCALE: N/A	PAGE: 1/1
		UNITS: mm	REV.: B

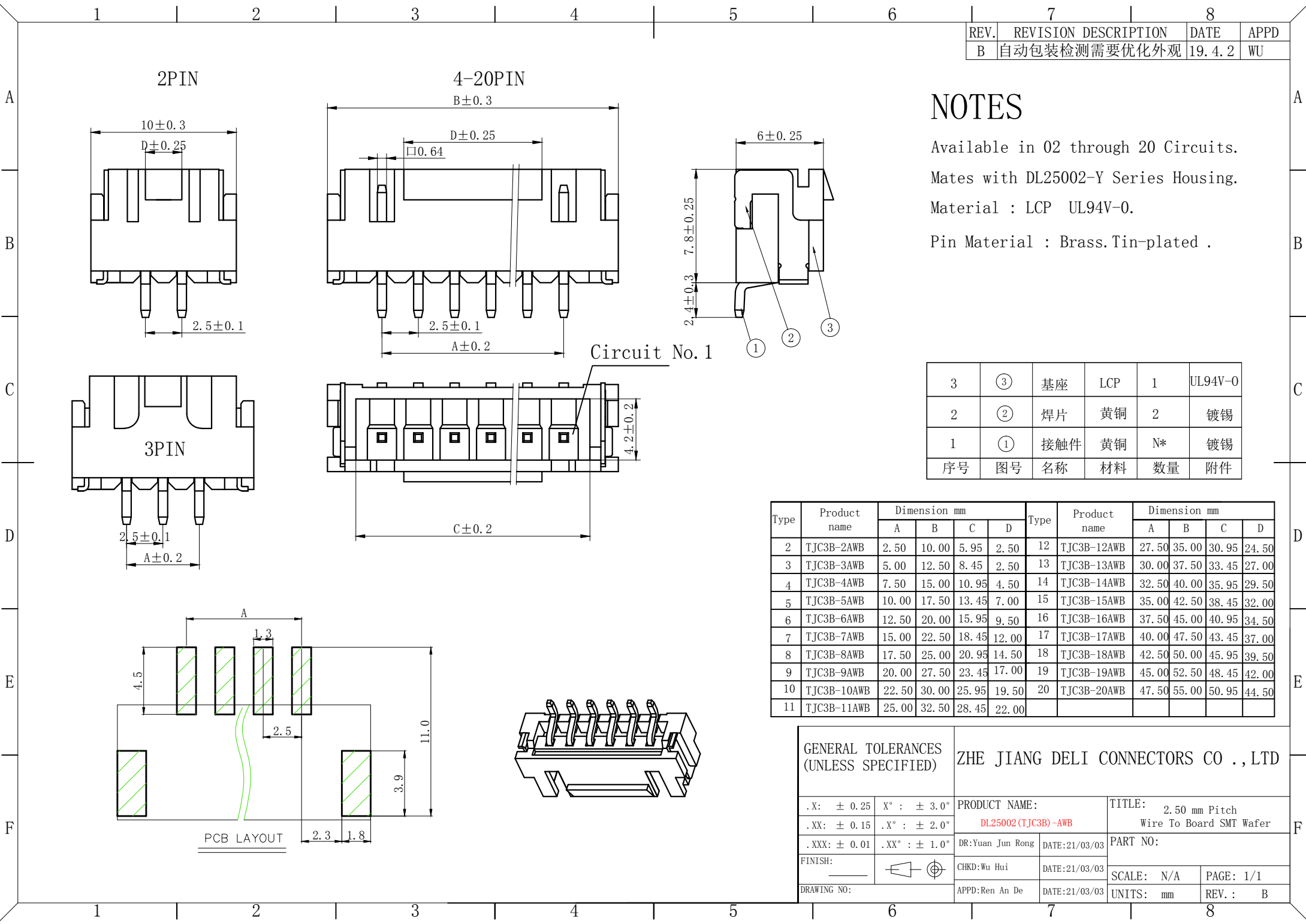

REV.	REVISION DESCRIPTION	DATE	Wu
B	更新外观结构	19.5.29	

2PIN

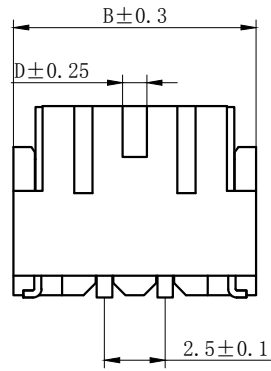

3-6PIN

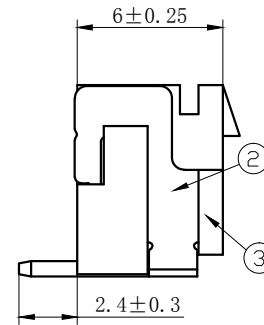
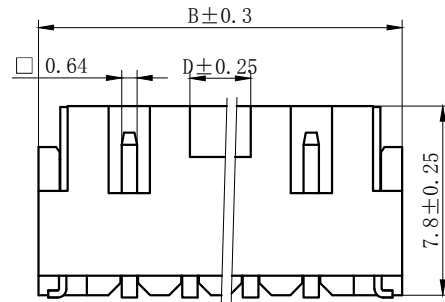

NOTES

Available in 02 through 05 Circuits.
Mates with DL25002-Y Series Housing.
Material : LCP UL94V-0.
Pin Material : Brass.Tin-plated .

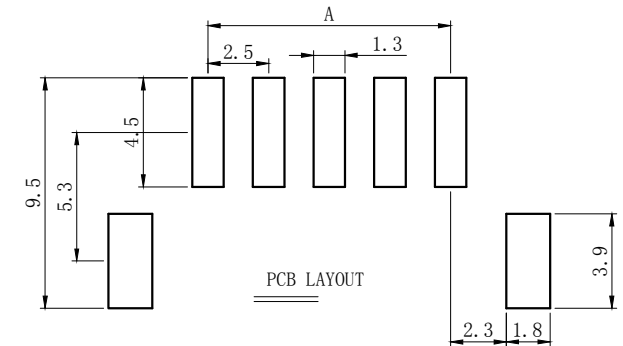
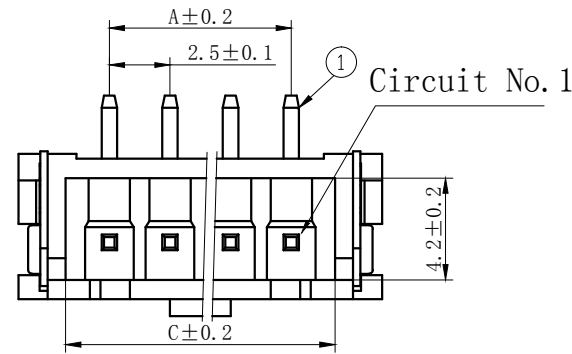
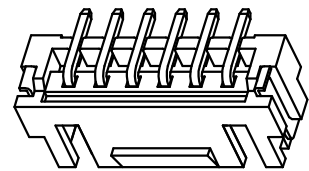

Type	Product name	Dimension mm			
		A	B	C	D
2	TJC3B-2ABJ	2.50	10.00	5.95	1.0
3	TJC3B-3ABJ	5.00	12.50	8.45	1.2
4	TJC3B-4ABJ	7.50	15.00	10.95	2.5
5	TJC3B-5ABJ	10.00	17.50	13.45	3.5

3	③	基座	LCP	1	UL94V-0
2	②	焊片	黄铜	2	镀锡
1	①	接触件	黄铜	N*	镀锡
序号	图号	名称	材料	数量	附件

GENERAL TOLERANCES (UNLESS SPECIFIED)		ZHE JIANG DELI CONNECTORS CO., LTD	
.X: ± 0.25	X°: ± 3.0°	PRODUCT NAME: DL25002(TJC3B)-ABJ	TITLE: 2.50 mm Pitch Wire To Board SMT Wafer
.XX: ± 0.15	.X°: ± 2.0°	DR:Wang Li Te	DATE:18/03/07
.XXX: ± 0.01	.XX°: ± 1.0°	CHKD:ZhangTing	DATE:18/03/07
FINISH:		APPD: Wu Hui	DATE:18/03/07
DRAWING NO:		SCALE: N/A	PAGE: 1/1
		UNITS: mm	REV.: B

REV.	REVISION DESCRIPTION	DATE	APPD
B	自动包装检测需要优化外观	19.4.2	WU

2PIN



3-6PIN



Circuit No. 1



NOTES

Available in 02 through 06 Circuits.
 Mates with DL25002-Y Series Housing.
 Material : LCP UL94V-0.
 Pin Material : Brass.Tin-plated .

Type	Product name	Dimension mm			
		A	B	C	D
2	TJC3B-2AWBJ	2.50	10.00	5.95	1.0
3	TJC3B-3AWBJ	5.00	12.50	8.45	1.2
4	TJC3B-4AWBJ	7.50	15.00	10.95	2.5
5	TJC3B-5AWBJ	10.00	17.50	13.45	3.5
6	TJC3B-6AWBJ	12.50	20.00	15.95	6.0

3	③	基座	LCP	1	UL94V-0
2	②	焊片	黄铜	2	镀锡
1	①	接触件	黄铜	N*	镀锡
序号	图号	名称	材料	数量	附件



GENERAL TOLERANCES (UNLESS SPECIFIED)		ZHE JIANG DELI CONNECTORS CO., LTD			
.X: ± 0.25	X°: ± 3.0°	PRODUCT NAME: DL25002(TJC3B)-AWBJ		TITLE: 2.50 mm Pitch Wire To Board SMT Wafer	
.XX: ± 0.15	.X°: ± 2.0°	DR:Yuan Jun Rong	DATE:21/03/03	PART NO:	
.XXX: ± 0.01	.XX°: ± 1.0°	CHKD:Wu Hui	DATE:21/03/03	SCALE: N/A	PAGE: 1/1
DRAWING NO:		APPD:Ren An De	DATE:21/03/03	UNITS: mm	REV.: B

REV.	REVISION DESCRIPTION	DATE	APPD

A

B

C

D

E

F

A

B

C

D

E

F

1

2

3

4

5

6

7

8



Circuit No. 1

MARK



3-5PIN

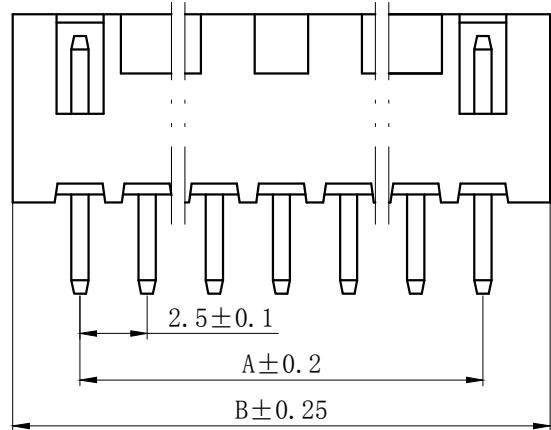

2.5±0.1

A±0.2

B±0.25

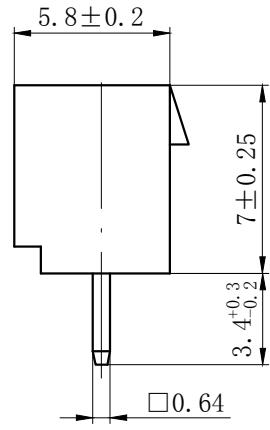

5.8±0.2

7±0.25

3.4+0.3/-0.2

0.64

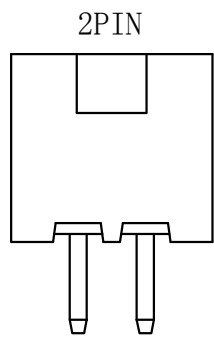

2PIN

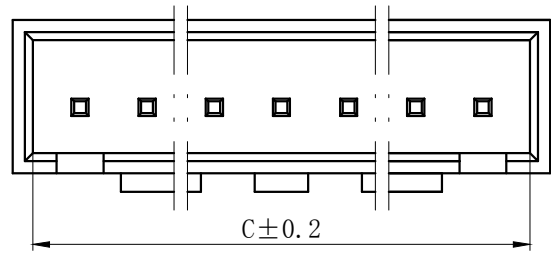

C±0.2

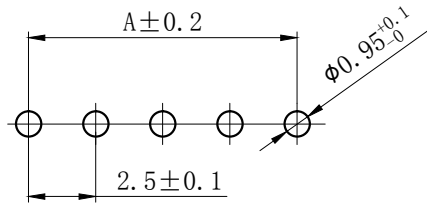

A±0.2

2.5±0.1

φ0.95+0.1/-0.1

PCB LAYOUT

NOTES

Available in 02 through 20 Circuits.
 Mates with DL25002-Y Series Housing.
 Material : Nylon UL94V-0 (2) .
 0.64mm Square Pin.
 Pin Material : Brass / Tin-Plated.

Circuits	Product name	Dimension mm			Circuits	Product name	Dimension mm		
		A	B	C			A	B	C
2	TJC3B-2A-Z	2.50	7.50	5.80	11	TJC3B-11A-Z	25.00	30.00	28.50
3	TJC3B-3A-Z	5.00	10.00	8.30	12	TJC3B-12A-Z	27.50	32.50	31.00
4	TJC3B-4A-Z	7.50	12.50	11.00	13	TJC3B-13A-Z	30.00	35.00	33.50
5	TJC3B-5A-Z	10.00	15.00	13.50	14	TJC3B-14A-Z	32.50	37.50	36.00
6	TJC3B-6A-Z	12.50	17.50	16.00	15	TJC3B-15A-Z	35.00	40.00	38.50
7	TJC3B-7A-Z	15.00	20.00	18.50	16	TJC3B-16A-Z	37.50	42.50	41.00
8	TJC3B-8A-Z	17.50	22.50	21.00	17	TJC3B-17A-Z	40.00	45.00	43.50
9	TJC3B-9A-Z	20.00	25.00	23.50	~	~	~	~	~
10	TJC3B-10A-Z	22.50	27.50	26.00	20	TJC3B-20A-Z	47.50	52.50	51.00

GENERAL TOLERANCES (UNLESS SPECIFIED)

.X: ± 0.25	X° : ± 3.0°
.XX: ± 0.15	.X° : ± 2.0°
.XXX: ± 0.01	.XX° : ± 1.0°
FINISH:	
DRAWING NO:	

ZHE JIANG DELI CONNECTORS CO., LTD

PRODUCT NAME: DL25002(TJC3B)-A-Z		TITLE: 2.50 mm Pitch Wire To Board Wafer	
DR: Yuan Jun Rong	DATE:21/08/01	PART NO:	
CHKD: Wu Hui	DATE:21/08/01	SCALE: N/A	PAGE: 1/1
APPD: Ren An De	DATE:21/08/01	UNITS: mm	REV.: A

1

2

3

4

5

6

7

8

REV.	REVISION DESCRIPTION	DATE	APPD

A

B

C

D

E

F

A

B

C

D

E

F

1

2

3

4

5

6

7

8



MARK

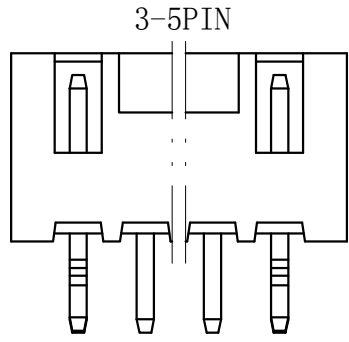

3-5PIN

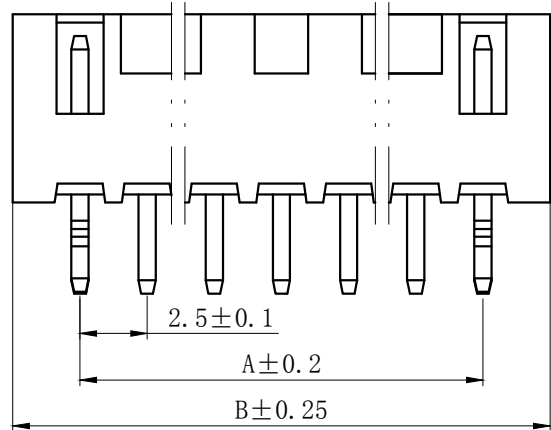

2PIN

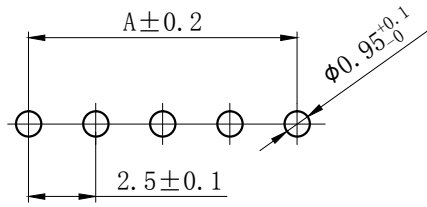
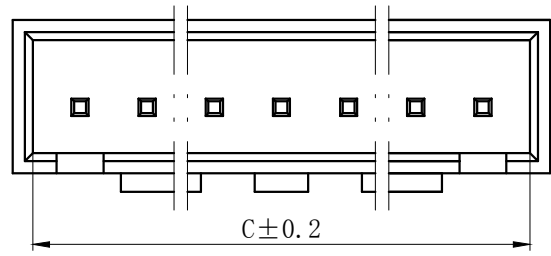
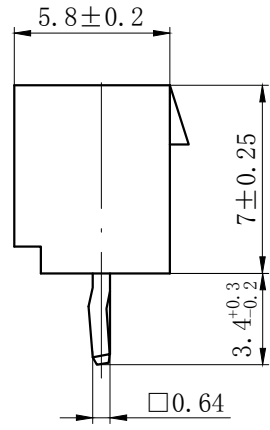
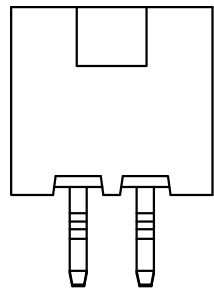

PCB LAYOUT

NOTES

Available in 02 through 20 Circuits.
 Mates with DL25002-Y Series Housing.
 Material : Nylon UL94V-0 (2) .
 0.64mm Square Pin.
 Pin Material : Brass / Tin-Plated.

Circuits	Product name	Dimension mm			Circuits	Product name	Dimension mm		
		A	B	C			A	B	C
2	TJC3B-2A-K	2.50	7.50	5.80	11	TJC3B-11A-K	25.00	30.00	28.50
3	TJC3B-3A-K	5.00	10.00	8.30	12	TJC3B-12A-K	27.50	32.50	31.00
4	TJC3B-4A-K	7.50	12.50	11.00	13	TJC3B-13A-K	30.00	35.00	33.50
5	TJC3B-5A-K	10.00	15.00	13.50	14	TJC3B-14A-K	32.50	37.50	36.00
6	TJC3B-6A-K	12.50	17.50	16.00	15	TJC3B-15A-K	35.00	40.00	38.50
7	TJC3B-7A-K	15.00	20.00	18.50	16	TJC3B-16A-K	37.50	42.50	41.00
8	TJC3B-8A-K	17.50	22.50	21.00	17	TJC3B-17A-K	40.00	45.00	43.50
9	TJC3B-9A-K	20.00	25.00	23.50	~	~	~	~	~
10	TJC3B-10A-K	22.50	27.50	26.00	20	TJC3B-20A-K	47.50	52.50	51.00

GENERAL TOLERANCES (UNLESS SPECIFIED)		ZHE JIANG DELI CONNECTORS CO., LTD	
.X: ± 0.25	X°: ± 3.0°	PRODUCT NAME: DL25002(TJC3B)-A-K	TITLE: 2.50 mm Pitch Wire To Board Wafer
.XX: ± 0.15	.X°: ± 2.0°	DR: Yuan Jun Rong	DATE:21/08/01
.XXX: ± 0.01	.XX°: ± 1.0°	CHKD: Wu Hui	DATE:21/08/01
DRAWING NO:		APPD: Ren An De	DATE:21/08/01
			PART NO:
			SCALE: N/A
			PAGE: 1/1
			UNITS: mm
			REV.: A

1

2

3

4

5

6

7

8

REV.	REVISION DESCRIPTION	DATE	APPD

NOTES

Available in 02 through 20 Circuits.
Mates with DL25002-Y Series Housing.
Material : Nylon UL94V-0 (2) .
0.64mm Square Pin.
Pin Material : Brass / Tin-Plated.

A
B
C
D
E
F

A
B
C
D
E
F

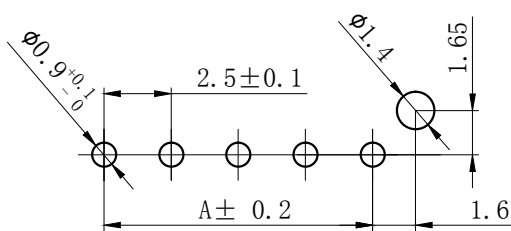
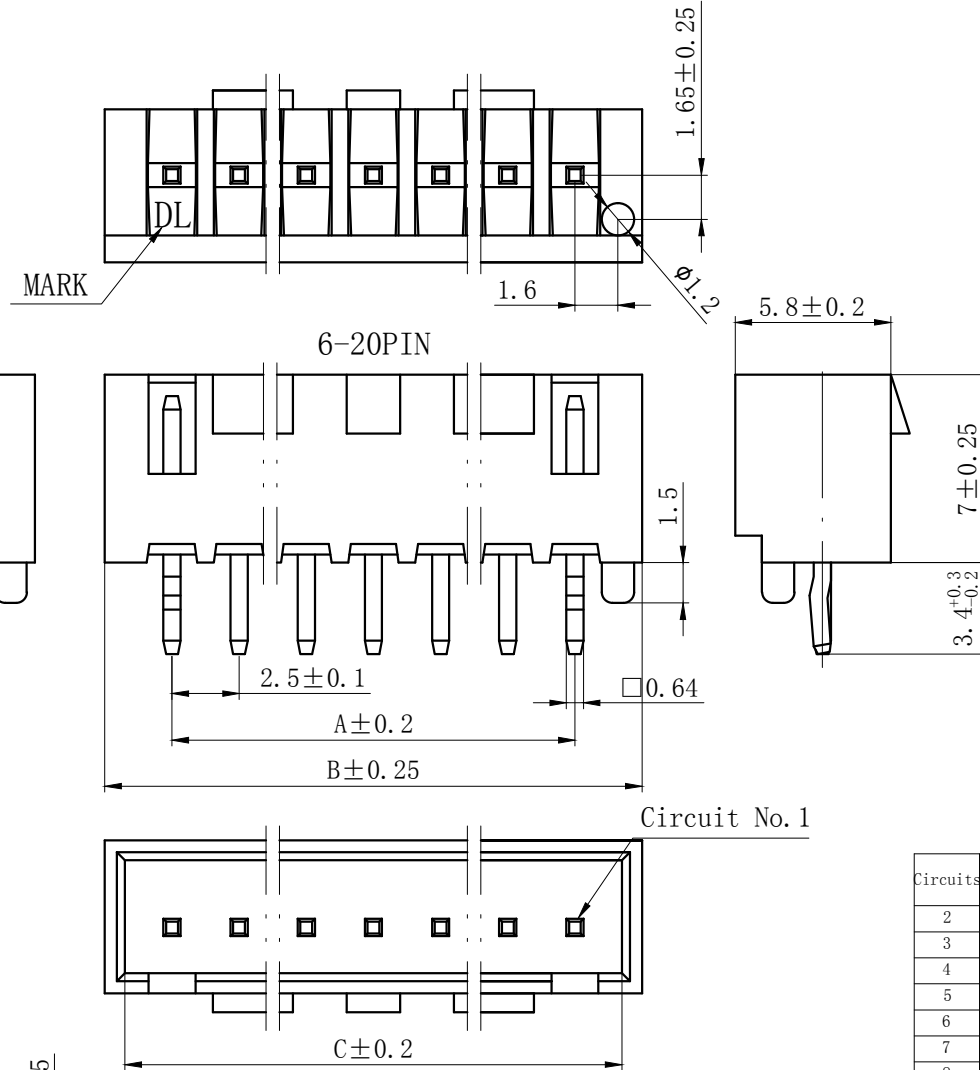

PCB LAYOUT

Circuits	Product name	Dimension mm			Circuits	Product name	Dimension mm		
		A	B	C			A	B	C
2	TJC3B-2AS-K	2.50	7.50	5.80	11	TJC3B-11AS-K	25.00	30.00	28.50
3	TJC3B-3AS-K	5.00	10.00	8.30	12	TJC3B-12AS-K	27.50	32.50	31.00
4	TJC3B-4AS-K	7.50	12.50	11.00	13	TJC3B-13AS-K	30.00	35.00	33.50
5	TJC3B-5AS-K	10.00	15.00	13.50	14	TJC3B-14AS-K	32.50	37.50	36.00
6	TJC3B-6AS-K	12.50	17.50	16.00	15	TJC3B-15AS-K	35.00	40.00	38.50
7	TJC3B-7AS-K	15.00	20.00	18.50	16	TJC3B-16AS-K	37.50	42.50	41.00
8	TJC3B-8AS-K	17.50	22.50	21.00	17	TJC3B-17AS-K	40.00	45.00	43.50
9	TJC3B-9AS-K	20.00	25.00	23.50	~	~	~	~	~
10	TJC3B-10AS-K	22.50	27.50	26.00	20	TJC3B-20AS-K	47.50	52.50	51.00

GENERAL TOLERANCES (UNLESS SPECIFIED)		ZHE JIANG DELI CONNECTORS CO., LTD	
.X: ± 0.25	X°: ± 3.0°	PRODUCT NAME:	TITLE: 2.50 mm Pitch Wire To Board Wafer
.XX: ± 0.15	.X°: ± 2.0°	DL25002(TJC3B)-AS-K	
.XXX: ± 0.01	.XX°: ± 1.0°	DR: Yuan Jun Rong	DATE:21/08/01
FINISH:		CHKD: Wu Hui	DATE:21/08/01
DRAWING NO:		APPD: Ren An De	DATE:21/08/01
		PART NO:	SCALE: N/A
			PAGE: 1/1
		UNITS: mm	REV.: A

1 2 3 4 5 6 7 8

REV.	REVISION DESCRIPTION	DATE	APPD

NOTES

Available in 02 through 20 Circuits.
 Mates with DL25002-Y Series Housing.
 Material : Nylon UL94V-0 (2) .
 0.64mm Square Pin.
 Pin Material : Brass / Tin-Plated.

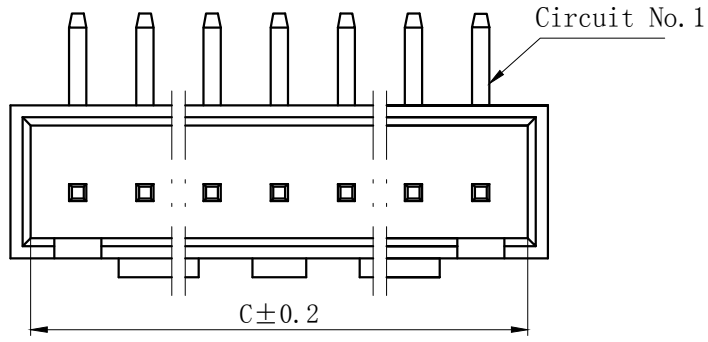
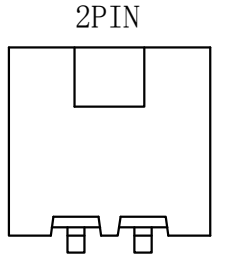
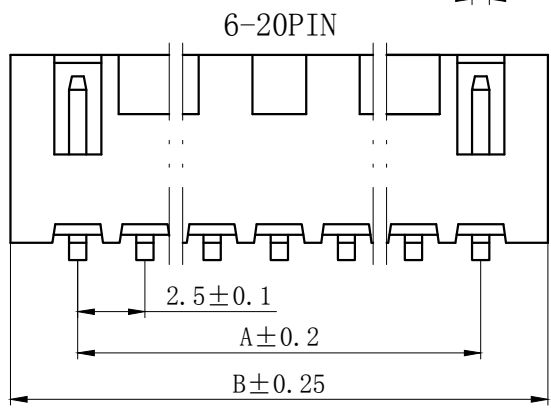
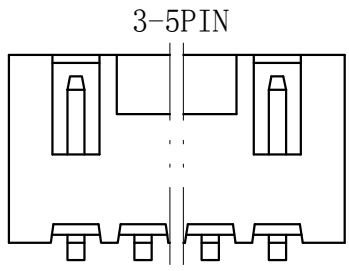
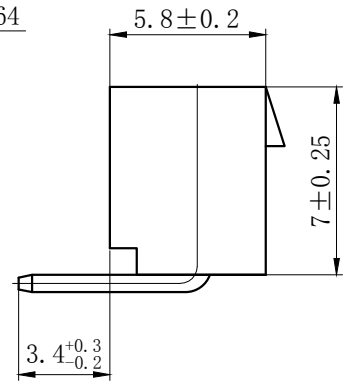
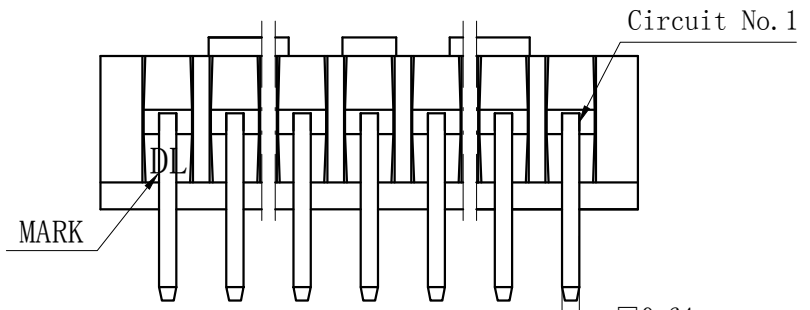

Circuits	Product name	Dimension mm			Circuits	Product name	Dimension mm		
		A	B	C			A	B	C
2	TJC3B-2AW-Z	2.50	7.50	5.80	11	TJC3B-11AW-Z	25.00	30.00	28.50
3	TJC3B-3AW-Z	5.00	10.00	8.30	12	TJC3B-12AW-Z	27.50	32.50	31.00
4	TJC3B-4AW-Z	7.50	12.50	11.00	13	TJC3B-13AW-Z	30.00	35.00	33.50
5	TJC3B-5AW-Z	10.00	15.00	13.50	14	TJC3B-14AW-Z	32.50	37.50	36.00
6	TJC3B-6AW-Z	12.50	17.50	16.00	15	TJC3B-15AW-Z	35.00	40.00	38.50
7	TJC3B-7AW-Z	15.00	20.00	18.50	16	TJC3B-16AW-Z	37.50	42.50	41.00
8	TJC3B-8AW-Z	17.50	22.50	21.00	17	TJC3B-17AW-Z	40.00	45.00	43.50
9	TJC3B-9AW-Z	20.00	25.00	23.50	~	~	~	~	~
10	TJC3B-10AW-Z	22.50	27.50	26.00	20	TJC3B-20AW-Z	47.50	52.50	51.00

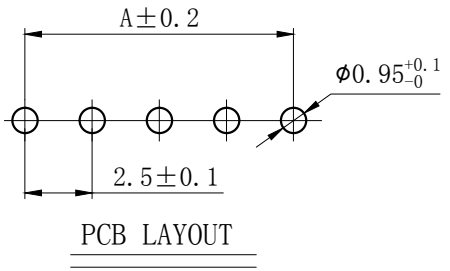

GENERAL TOLERANCES (UNLESS SPECIFIED)		ZHE JIANG DELI CONNECTORS CO., LTD	
.X: ± 0.25	X°: ± 3.0°	PRODUCT NAME: DL25002(TJC3B)-AW-Z	TITLE: 2.50 mm Pitch Wire To Board Wafer
.XX: ± 0.15	.X°: ± 2.0°	DR: Yuan Jun Rong	DATE:21/08/01
.XXX: ± 0.01	.XX°: ± 1.0°	CHKD: Wu Hui	DATE:21/08/01
DRAWING NO:		APPD: Ren An De	DATE:21/08/01
		PART NO:	
		SCALE: N/A	PAGE: 1/1
		UNITS: mm	REV.: A

REV.	REVISION DESCRIPTION	DATE	APPD

NOTES

Available in 02 through 20 Circuits.
 Mates with DL25002-Y Series Housing.
 Material : Nylon UL94V-0 (2) .
 0.64mm Square Pin.
 Pin Material : Brass / Tin-Plated.



Circuits	Type	Dimension mm			Circuits	Type	Dimension mm		
		A	B	C			A	B	C
2	TJC3B-2AWD	2.50	7.50	5.80	11	TJC3B-11AWD	25.00	30.00	28.50
3	TJC3B-3AWD	5.00	10.00	8.30	12	TJC3B-12AWD	27.50	32.50	31.00
4	TJC3B-4AWD	7.50	12.50	11.00	13	TJC3B-13AWD	30.00	35.00	33.50
5	TJC3B-5AWD	10.00	15.00	13.50	14	TJC3B-14AWD	32.50	37.50	36.00
6	TJC3B-6AWD	12.50	17.50	16.00	15	TJC3B-15AWD	35.00	40.00	38.50
7	TJC3B-7AWD	15.00	20.00	18.50	16	TJC3B-16AWD	37.50	42.50	41.00
8	TJC3B-8AWD	17.50	22.50	21.00	17	TJC3B-17AWD	40.00	45.00	43.50
9	TJC3B-9AWD	20.00	25.00	23.50	~	~	~	~	~
10	TJC3B-10AWD	22.50	27.50	26.00	20	TJC3B-20AWD	47.50	52.50	51.00

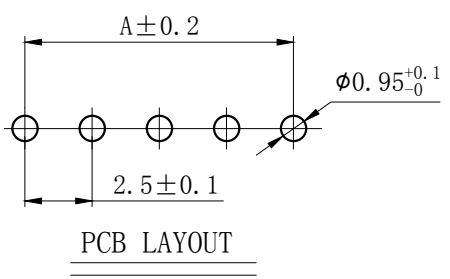

GENERAL TOLERANCES (UNLESS SPECIFIED)		ZHE JIANG DELI CONNECTORS CO., LTD	
.X: ± 0.25	X° : ± 3.0°	PRODUCT NAME:	TITLE: 2.50 mm Pitch Wire To Board Wafer
.XX: ± 0.15	.X° : ± 2.0°	DL25002 (TJC3B)-AWD	
.XXX: ± 0.01	.XX° : ± 1.0°	DR: Yuan Jun Rong	DATE:21/08/01
FINISH:		CHKD: Wu Hui	DATE:21/08/01
DRAWING NO:		APPD: Ren An De	DATE:21/08/01
		PART NO:	SCALE: N/A
			PAGE: 1/1
		UNITS: mm	REV.: A

REV.	REVISION DESCRIPTION	DATE	APPD

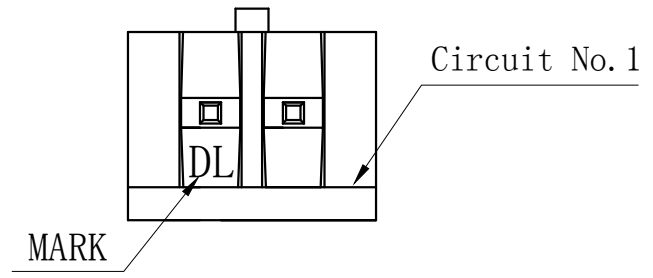

NOTES

Available in 02 Circuits.
 Mates with DL25002-Y Series Housing.
 Material : Nylon UL94V-0 (2) .
 0.64mm Square Pin.
 Pin Material : Brass / Tin-Plated.

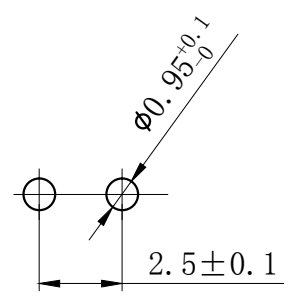
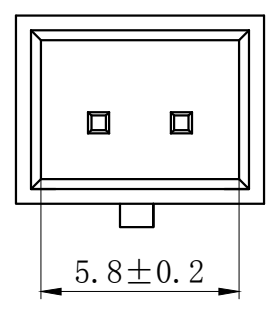
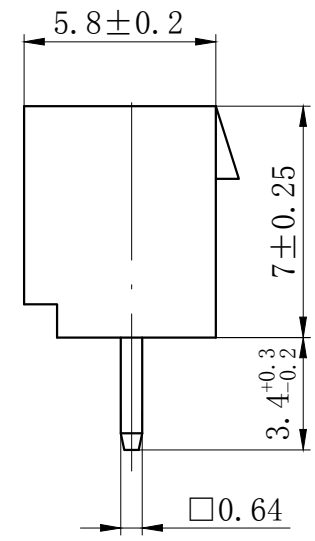
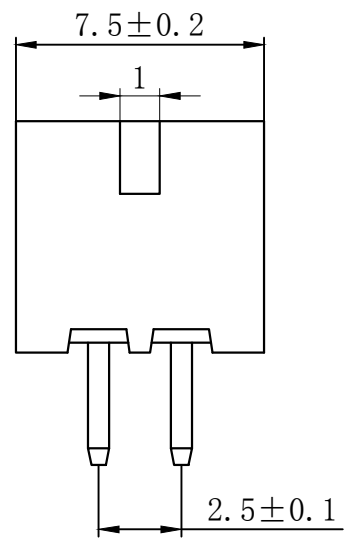

PCB LAYOUT

GENERAL TOLERANCES (UNLESS SPECIFIED)		ZHE JIANG DELI CONNECTORS CO., LTD	
.X: ± 0.25	X° : ± 3.0°	PRODUCT NAME:	TITLE: 2.50 mm Pitch Wire To Board Wafer
.XX: ± 0.15	.X° : ± 2.0°	DL25002 (TJC3B)-2AJ-Z	
.XXX: ± 0.01	.XX° : ± 1.0°	DR: Yuan Jun Rong	DATE: 21/08/01
FINISH:		CHKD: Wu Hui	DATE: 21/08/01
DRAWING NO:		APPD: Ren An De	DATE: 21/08/01
		SCALE: N/A	PAGE: 1/1
		UNITS: mm	REV.: A

REV.	REVISION DESCRIPTION	DATE	APPD

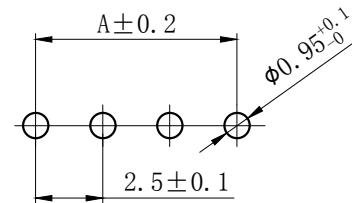
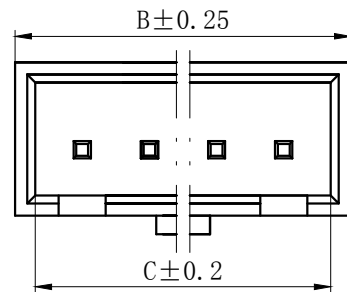
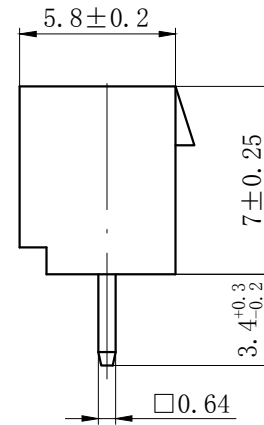
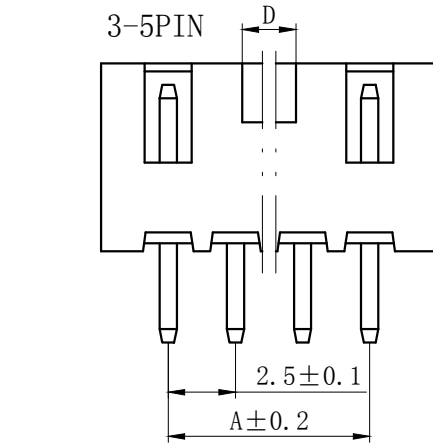
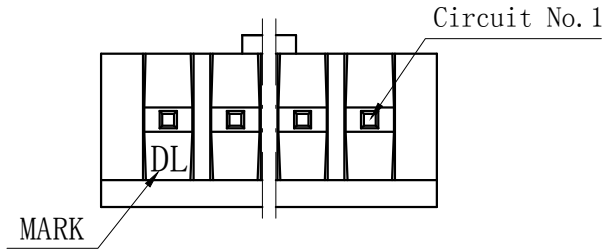

PCB LAYOUT

NOTES

Available in 02 through 05 Circuits.
Mates with DL25002-Y Series Housing.
Material : Nylon UL94V-0 (2) .
0.64mm Square Pin.
Pin Material : Brass / Tin-Plated.

Circuits	Type	Dimension mm			
		A	B	C	D
3	TJC3B-3AJ-Z	5.00	10.00	8.30	1.00
4	TJC3B-4AJ-Z	7.50	12.50	11.00	2.00
5	TJC3B-5AJ-Z	10.00	15.00	13.50	2.20

GENERAL TOLERANCES (UNLESS SPECIFIED)		ZHE JIANG DELI CONNECTORS CO., LTD	
.X: ± 0.25	X°: ± 3.0°	PRODUCT NAME: DL25002(TJC3B)-AJ-Z	TITLE: 2.50 mm Pitch Wire To Board Wafer
.XX: ± 0.15	.X°: ± 2.0°	DR: Yuan Jun Rong	DATE:21/08/01
.XXX: ± 0.01	.XX°: ± 1.0°	CHKD: Wu Hui	DATE:21/08/01
FINISH:		APPD: Ren An De	DATE:21/08/01
DRAWING NO:			
		PART NO:	SCALE: N/A
			PAGE: 1/1
		UNITS: mm	REV.: A

REV.	REVISION DESCRIPTION	DATE	APPD

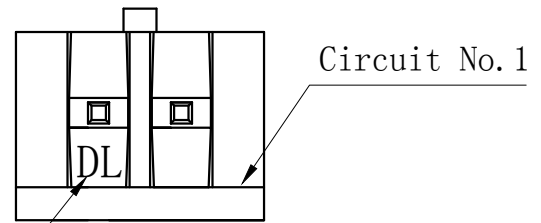

Circuit No. 1

MARK

NOTES

Available in 02 Circuits.
 Mates with DL25002-Y Series Housing.
 Material : Nylon UL94V-0 (2) .
 0.64mm Square Pin.
 Pin Material : Brass / Tin-Plated.

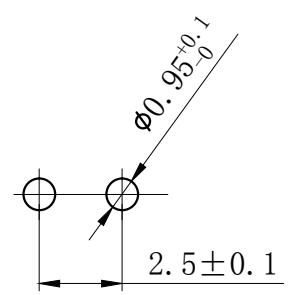
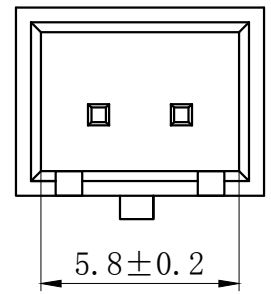
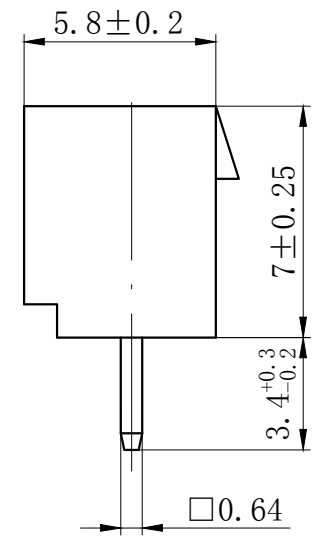
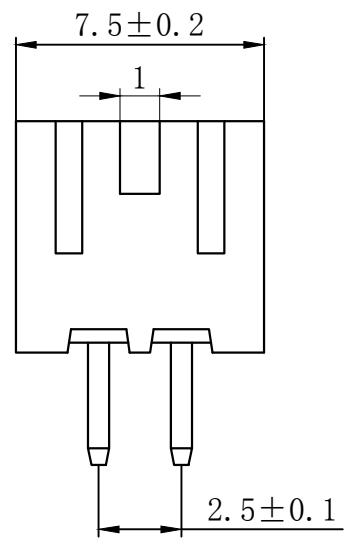

PCB LAYOUT

GENERAL TOLERANCES (UNLESS SPECIFIED)		ZHE JIANG DELI CONNECTORS CO., LTD	
.X: ± 0.25	X° : ± 3.0°	PRODUCT NAME: DL25002 (TJC3B)-2AJ-KC	TITLE: 2.50 mm Pitch Wire To Board Wafer
.XX: ± 0.15	.X° : ± 2.0°	DR: Yuan Jun Rong	DATE: 21/08/01
.XXX: ± 0.01	.XX° : ± 1.0°	CHKD: Wu Hui	DATE: 21/08/01
DRAWING NO:		APPD: Ren An De	DATE: 21/08/01
			PART NO:
			SCALE: N/A
			PAGE: 1/1
			UNITS: mm
			REV.: A

REV.	REVISION DESCRIPTION	DATE	APPD

NOTES

Available in 02 through 20 Circuits.
 Match with DL25002-Y series housing
 Material : Nylon UL94V-0(2).
 Accepts DL25002-RT Crimp Terminal.

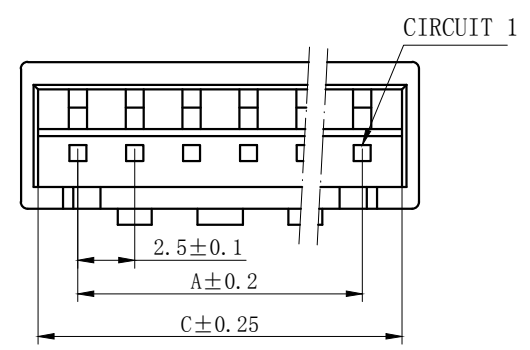
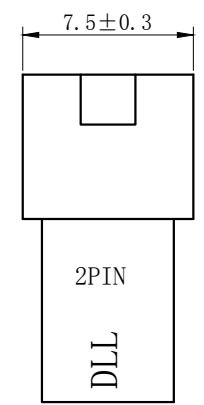
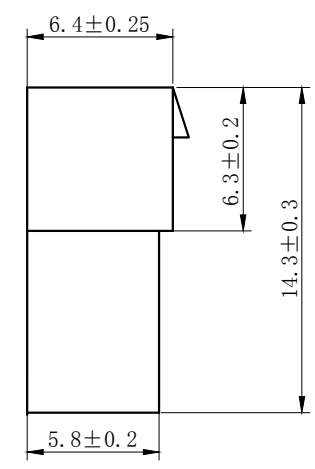
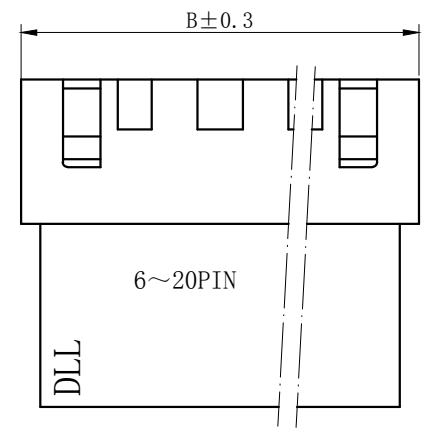
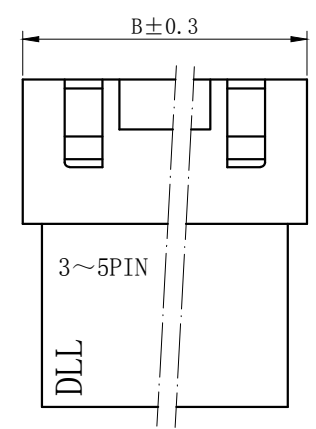
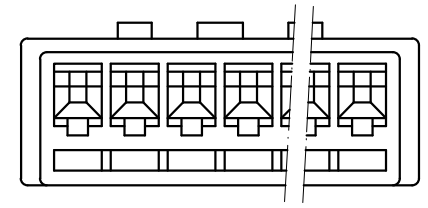

Circuits	Product name	Dimension mm			Circuits	Product name	Dimension mm		
		A	B	C			A	B	C
2	TJC3B-2R	2.50	7.50	6.00	10	TJC3B-10R	22.50	27.50	26.00
3	TJC3B-3R	5.00	10.00	8.50	11	TJC3B-11R	25.00	30.00	28.50
4	TJC3B-4R	7.50	12.50	11.00	12	TJC3B-12R	27.50	32.50	31.00
5	TJC3B-5R	10.00	15.00	13.50	13	TJC3B-13R	30.00	35.00	33.50
6	TJC3B-6R	12.50	17.50	16.00	14	TJC3B-14R	32.50	37.50	36.00
7	TJC3B-7R	15.00	20.00	18.50	15	TJC3B-15R	35.00	40.00	38.50
8	TJC3B-8R	17.50	22.50	21.00	-	-	-	-	-
9	TJC3B-9R	20.00	25.00	23.50	20	TJC3B-20R	47.50	52.50	51.00

GENERAL TOLERANCES (UNLESS SPECIFIED)		ZHE JIANG DELI CONNECTORS CO., LTD			
.X: ± 0.25	X°: ± 3.0°	PRODUCT NAME: DL25002(TJC3B)-R		TITLE: 2.50 mm Pitch Wire To Wire Housing	
.XX: ± 0.15	.X°: ± 2.0°	DR:Chen Quan Long		DATE:20/12/30	
.XXX: ± 0.01	.XX°: ± 1.0°	FINISH: _____		PART NO:	
DRAWING NO:		CHKD: Wu Hui		DATE:20/12/30	
		APPD:Ren An De		DATE:20/12/30	
		UNITS: mm		SCALE: N/A	
		REV.: A		PAGE: 1/1	

REV.	7	REVISION DESCRIPTION	8	DATE	APPD

NOTES

Available in 02 through 20 Circuits.
 Match with DL25002 series housing
 Material : Nylon UL94V-0(2).
 Accepts DL25002-T Crimp Terminal.



C3B-2Y

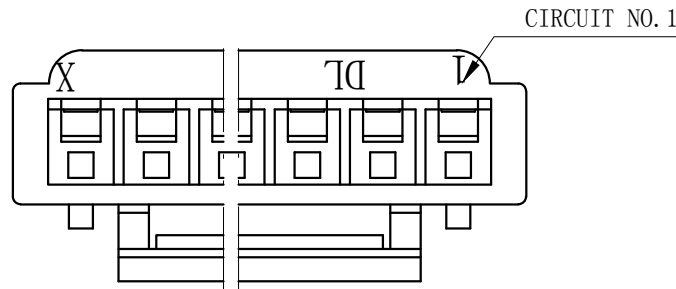
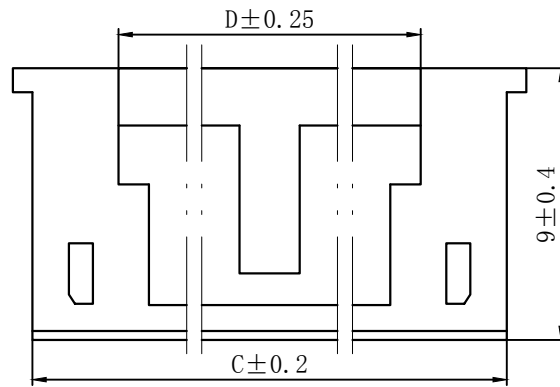

Circuits	Product name	Dimension mm				Circuits	Product name	Dimension mm			
		A	B	C	D			A	B	C	D
2	TJC3B-2Y	2.50	7.00	5.70	5.30	12	TJC3B-12Y	27.50	32.00	30.70	15.1
3	TJC3B-3Y	5.00	9.50	8.20	5.10	13	TJC3B-13Y	30.00	34.50	33.20	15.1
4	TJC3B-4Y	7.50	12.00	10.70	5.10	14	TJC3B-14Y	32.50	37.00	35.70	15.1
5	TJC3B-5Y	10.00	14.50	13.20	7.60	15	TJC3B-15Y	35.00	39.50	38.20	15.1
6	TJC3B-6Y	12.50	17.00	15.70	10.10	16	TJC3B-16Y	37.50	42.00	40.70	15.1
7	TJC3B-7Y	15.00	19.50	18.20	12.60	17	TJC3B-17Y	40.00	44.50	43.20	15.1
8	TJC3B-8Y	17.50	22.00	20.70	15.10	18	TJC3B-18Y	42.50	47.00	45.70	15.1
9	TJC3B-9Y	20.00	24.50	23.20	17.60	19	TJC3B-19Y	45.00	49.50	48.20	15.1
10	TJC3B-10Y	22.50	27.00	25.70	15.10	20	TJC3B-20Y	47.50	52.00	50.70	15.1
11	TJC3B-11Y	25.00	29.50	28.20	15.10						

GENERAL TOLERANCES (UNLESS SPECIFIED)		ZHE JIANG DELI CONNECTORS CO., LTD			
.X: ± 0.25	X°: ± 3.0°	PRODUCT NAME: DL25002 (TJC3B)-Y		TITLE: 2.50 mm Pitch Housing	
.XX: ± 0.15	.X°: ± 2.0°	DR: Yuan Jun Rong	DATE: 21/03/18	PART NO:	
.XXX: ± 0.01	.XX°: ± 1.0°	CHKD: Wu Hui	DATE: 21/03/18	SCALE: N/A	PAGE: 1/1
DRAWING NO:		APPD: Ren An De	DATE: 21/03/18	UNITS: mm	REV.: A

REV.	REVISION DESCRIPTION	DATE	APPD

NOTES

Available in 02 through 20 Circuits.
 Match with DL25001-Y series housing
 Material : Nylon UL94V-0(2).



Circuits	Product name	Dimension mm		Circuits	Product name	Dimension mm	
		A	B			A	B
2	TJC3-2S	2.50	8.7	9	TJC3-9S	20.00	26.2
3	TJC3-3S	5.00	11.2	10	TJC3-10S	22.50	28.7
4	TJC3-4S	7.50	13.7	11	TJC3-11S	25.00	31.2
5	TJC3-5S	10.00	16.2	12	TJC3-12S	27.50	33.7
6	TJC3-6S	12.50	18.7	13	TJC3-13S	30.00	36.2
7	TJC3-7S	15.00	21.2	~	~	~	~
8	TJC3-8S	17.50	23.7	20	TJC3-20S	47.80	53.7

GENERAL TOLERANCES (UNLESS SPECIFIED)		ZHE JIANG DELI CONNECTORS CO., LTD			
.X: ± 0.25	X°: ± 3.0°	PRODUCT NAME: DL25001(TJC3)-S		TITLE: 2.50 mm Pitch Housing	
.XX: ± 0.15	.X°: ± 2.0°	DR: Yuan Jun Rong	DATE:21/03/18	PART NO:	
.XXX: ± 0.01	.XX°: ± 1.0°	CHKD: Wu Hui	DATE:21/03/18	SCALE: N/A	PAGE: 1/1
FINISH:		APPD: Ren An De	DATE:21/03/18	UNITS: mm	REV.: A
DRAWING NO:					

REV.	REVISION DESCRIPTION	DATE	APPD

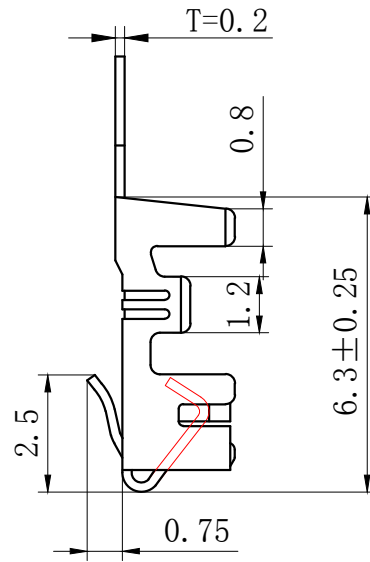
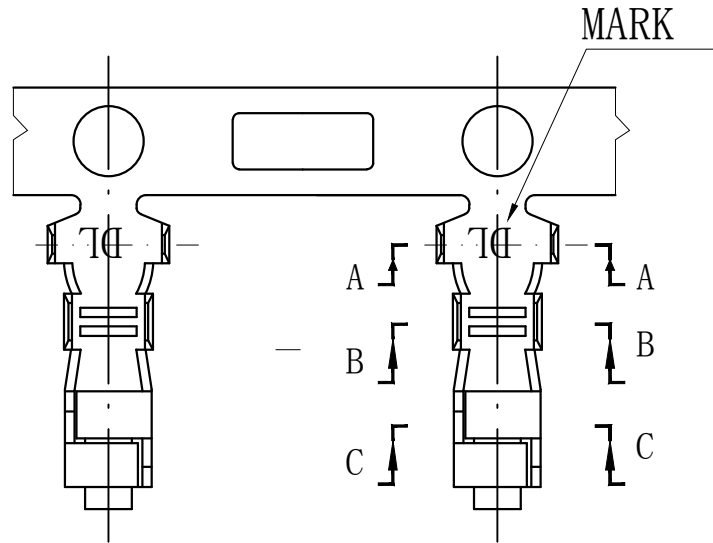

NOTES

Used in DL25001-Y Series Housing.
Accepts AWG #28~22 Wire Range.

0.08~ 0.33 mm² .

Insulation O.D.=1.2~1.9 mm.

Material : Phosphor Bronze .

Finish: Tin plated.

Thickness: 0.2 mm.

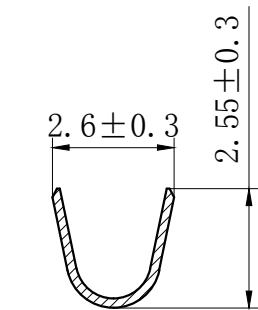

SECTION A-A



SECTION B-B

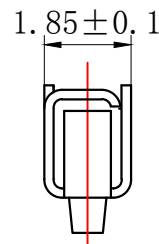

SECTION C-C

GENERAL TOLERANCES (UNLESS SPECIFIED)		ZHE JIANG DELI CONNECTORS CO., LTD	
.X: ± 0.25	X° : ± 3.0°	PRODUCT NAME: DL25001 (TJC3)-T	TITLE: 2.50 mm Pitch Crimp Terminal
.XX: ± 0.15	.X° : ± 2.0°	DR: Chen Quan Long	DATE: 19/08/01
.XXX: ± 0.01	.XX° : ± 1.0°	CHKD: Wu Hui	DATE: 19/08/01
FINISH:		APPD: Ren An De	DATE: 19/08/01
DRAWING NO:		SCALE: N/A	PAGE: 1/1
		UNITS: mm	REV.: A

REV.	REVISION DESCRIPTION	DATE	APPD



NOTES

Used in DL25001-Y Series Housing.
 Accepts AWG #24~20 Wire Range.
 Material : Phosphor Bronze .
 Finish: Tin plated.
 Thickness: 0.2 mm.

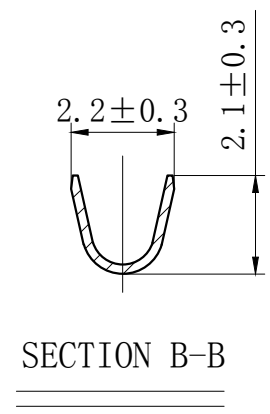

GENERAL TOLERANCES (UNLESS SPECIFIED)		ZHE JIANG DELI CONNECTORS CO., LTD	
.X: ± 0.25	X° : ± 3.0°	PRODUCT NAME: DL25001(TJC3)-T-G	TITLE: 2.50 mm Pitch Crimp Terminal
.XX: ± 0.15	.X° : ± 2.0°	DR: Chen Quan Long	DATE: 19/08/01
.XXX: ± 0.01	.XX° : ± 1.0°	CHKD: Wu Hui	DATE: 19/08/01
FINISH:		APPD: Ren An De	DATE: 19/08/01
DRAWING NO:			

REV.	REVISION DESCRIPTION	DATE	APPD

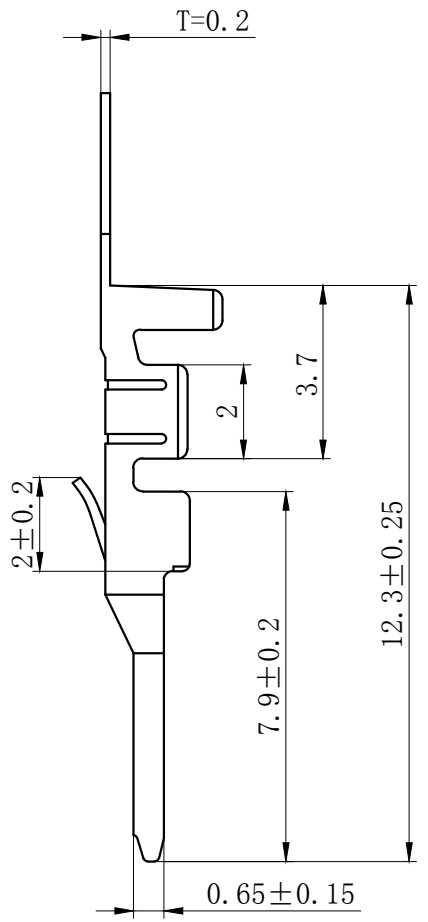
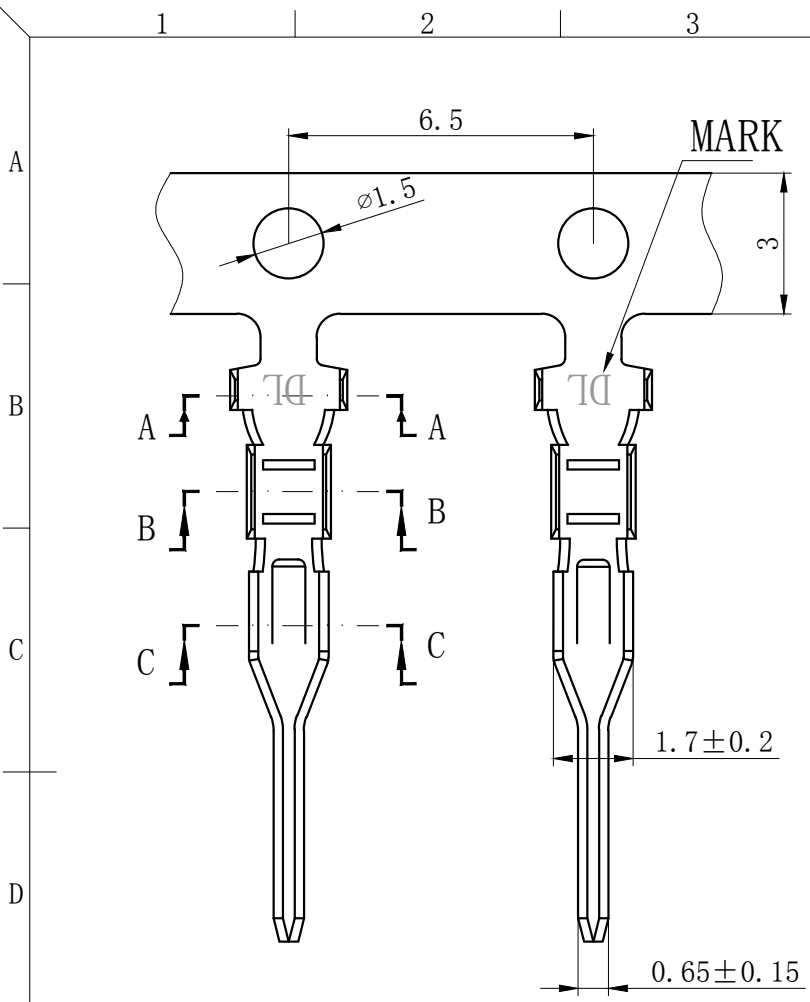

NOTES

Used in DL25002-R Series Housing.
 Accepts AWG #28~22 Wire Range.
 0.08~ 0.33 mm² .
 Insulation O.D.=1.2~1.9 mm.
 Material : Phosphor Bronze .
 Finish: Tin plated.
 Thickness: 0.2 mm.

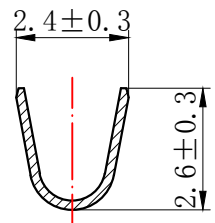

SECTION A-A

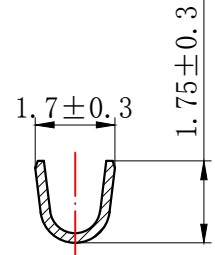

SECTION B-B

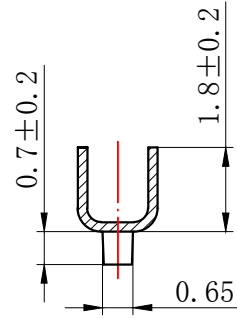

SECTION C-C

GENERAL TOLERANCES (UNLESS SPECIFIED)				ZHE JIANG DELI CONNECTORS CO., LTD			
.X: ± 0.25	X°: ± 3.0°	PRODUCT NAME: DL25002 (TJC3B)-RT		TITLE: 2.50 mm Pitch Wire To Wire Terminal			
.XX: ± 0.15	.X°: ± 2.0°	DR: Chen Quan Long	DATE: 20/12/30	PART NO:			
.XXX: ± 0.01	.XX°: ± 1.0°	CHKD: Wu Hui	DATE: 20/12/30	SCALE: N/A	PAGE: 1/1		
DRAWING NO:		APPD: Ren An De	DATE: 20/12/30	UNITS: mm	REV.: A		

X-ON Electronics

Largest Supplier of Electrical and Electronic Components

Click to view similar products for [Headers & Wire Housings](#) category:

Click to view products by [DLL](#) manufacturer:

Other Similar products are found below :

[0015917161](#) [0022155065](#) [57102-F02-18ULF](#) [58102-G61-06LF](#) [582553-1](#) [01.001.5753.1](#) [0050291907](#) [02.125.8002.8](#) [609-3404](#) [61062-3](#)
[CSU011177004](#) [622-0430](#) [622-3653LF](#) [63453-116](#) [636-1030](#) [636-1427](#) [636-3427](#) [636-4007](#) [641938-9](#) [65495-038](#) [65692-001LF](#) [65781-018](#)
[65781-047](#) [65817-010LF](#) [65817-015LF](#) [67095-007LF](#) [67601157](#) [68631-112](#) [68645-018](#) [699319-000](#) [70.362.1628.0](#) [70-4210](#) [70-4226B](#) [70-](#)
[4853B](#) [71.350.2428.0](#) [733-134](#) [733-162](#) [MHR-64-VUAL](#) [80.063.4001.1](#) [800-90-001-10-001000](#) [801-43-002-10-013000](#) [801-43-006-10-](#)
[002000](#) [803-43-024-10-001000](#) [803-93-012-10-001000](#) [8-1437020-4](#) [819-22-004-30-001101](#) [820-22-006-30-001101](#) [820-22-008-30-001101](#)
[821-22-002-10-001101](#) [821-22-003-10-002101](#)