



技术特性/Specifications:

额定电压 Rated voltage: 250V AC, DC
额定电流 Rated current: 3A AC, DC
接触电阻 Contact resistance: 20m Ω max
绝缘电阻 Insulation resistance: 1000M Ω min
耐压 Withstand voltage: 1000V AC/minute
环境温度 Ambient temperature: -40 $^{\circ}$ C~+105 $^{\circ}$ C
适用线规 Wire range: AWG#28~#22

REV.	REVISION DESCRIPTION	DATE	APPD



NOTES

Available in 02 through 15 Circuits.
Mates with DL25002-Y Series Housing.
Material : Nylon UL94V-0(2).
0.64mm Square Pin.
Pin Material : Brass / Tin-Plated.

Circuits	Product name	Dimension mm			Circuits	Product name	Dimension mm		
		A	B	C			A	B	C
2	TJC3B-H-2A-11.2	2.50	7.50	5.70	10	TJC3B-H-10A-11.2	22.50	27.50	25.70
3	TJC3B-H-3A-11.2	5.00	10.00	8.20	11	TJC3B-H-11A-11.2	25.00	30.00	28.20
4	TJC3B-H-4A-11.2	7.50	12.50	10.70	12	TJC3B-H-12A-11.2	27.50	32.50	30.70
5	TJC3B-H-5A-11.2	10.00	15.00	13.20	13	TJC3B-H-13A-11.2	30.00	35.00	33.20
6	TJC3B-H-6A-11.2	12.50	17.50	15.70	14	TJC3B-H-14A-11.2	32.50	37.50	35.70
7	TJC3B-H-7A-11.2	15.00	20.00	18.20	15	TJC3B-H-15A-11.2	35.00	40.00	38.20
8	TJC3B-H-8A-11.2	17.50	22.50	20.70	-	-	-	-	-
9	TJC3B-H-9A-11.2	20.00	25.00	23.20	-	-	-	-	-

GENERAL TOLERANCES (UNLESS SPECIFIED)		ZHE JIANG DELI CONNECTORS CO., LTD	
.X: ± 0.25	X° : ± 3.0°	PRODUCT NAME: DL25029(TJC3B-H)-A-11.2	TITLE: 2.50 mm Pitch Wire To Board Wafer
.XX: ± 0.15	.X° : ± 2.0°	DR:Chen Quan Long	DATE:18/03/01
.XXX: ± 0.01	.XX° : ± 1.0°	CHKD: Wu Hui	DATE:18/03/01
FINISH:		APPD:Ren An De	DATE:18/03/01
DRAWING NO:			SCALE: N/A
			PAGE: 1/1
			UNITS: mm
			REV.: A

REV.	REVISION DESCRIPTION	DATE	APPD

NOTES

Available in 02 through 15 Circuits.
 Mates with DL25002-Y Series Housing.
 Material : Nylon UL94V-0(2).
 0.64mm Square Pin.
 Pin Material : Brass / Tin-Plated.

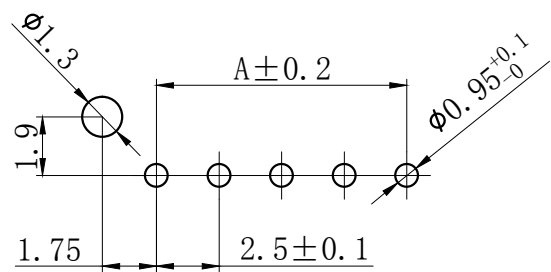
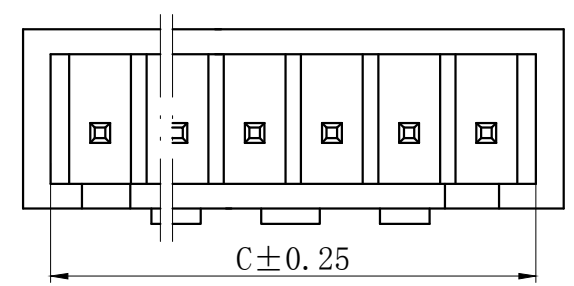
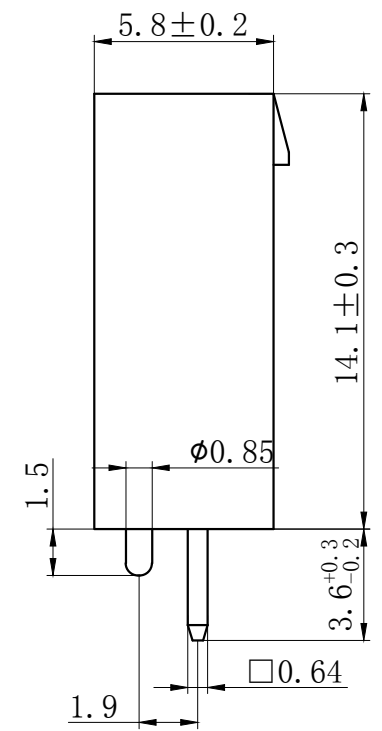
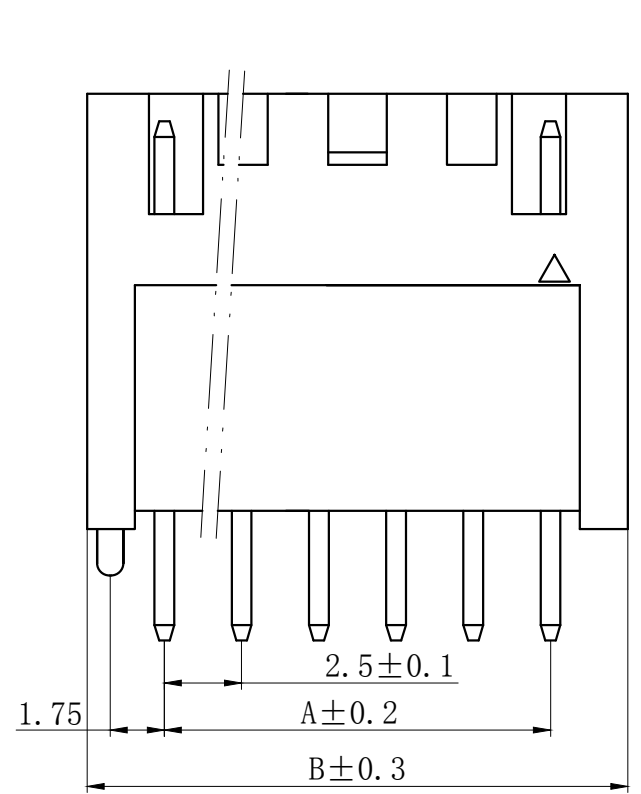

P. C. B LATOUT

Circuits	Product name	Dimension mm			Circuits	Product name	Dimension mm		
		A	B	C			A	B	C
2	TJC3B-H-2AS	2.50	7.50	5.70	10	TJC3B-H-10AS	22.50	27.50	25.70
3	TJC3B-H-3AS	5.00	10.00	8.20	11	TJC3B-H-11AS	25.00	30.00	28.20
4	TJC3B-H-4AS	7.50	12.50	10.70	12	TJC3B-H-12AS	27.50	32.50	30.70
5	TJC3B-H-5AS	10.00	15.00	13.20	13	TJC3B-H-13AS	30.00	35.00	33.20
6	TJC3B-H-6AS	12.50	17.50	15.70	14	TJC3B-H-14AS	32.50	37.50	35.70
7	TJC3B-H-7AS	15.00	20.00	18.20	15	TJC3B-H-15AS	35.00	40.00	38.20
8	TJC3B-H-8AS	17.50	22.50	20.70	-	-	-	-	-
9	TJC3B-H-9AS	20.00	25.00	23.20	-	-	-	-	-

GENERAL TOLERANCES (UNLESS SPECIFIED)		ZHE JIANG DELI CONNECTORS CO., LTD			
.X: ± 0.25	X°: ± 3.0°	PRODUCT NAME: DL25029 (TJC3B-H)-AS		TITLE: 2.50 mm Pitch Wire To Board Wafer	
.XX: ± 0.15	.X°: ± 2.0°	DR: Chen Quan Long	DATE: 18/03/01	PART NO:	
.XXX: ± 0.01	.XX°: ± 1.0°	CHKD: Wu Hui	DATE: 18/03/01	SCALE: N/A	PAGE: 1/1
DRAWING NO:		APPD: Ren An De	DATE: 18/03/01	UNITS: mm	REV.: A

REV.	REVISION DESCRIPTION	DATE	APPD

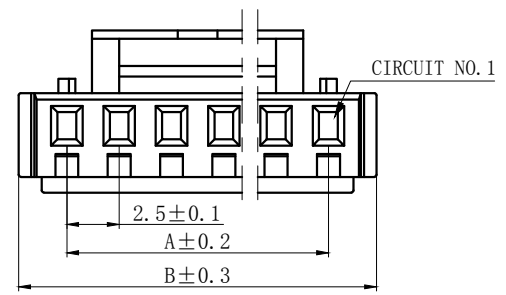

NOTES

Available in 02 through 15 Circuits.
 Match with DL25029 series housing
 Material : Nylon UL94V-0(2).
 Accepts DL25029-T Crimp Terminal.

2-3PIN

6PIN以上

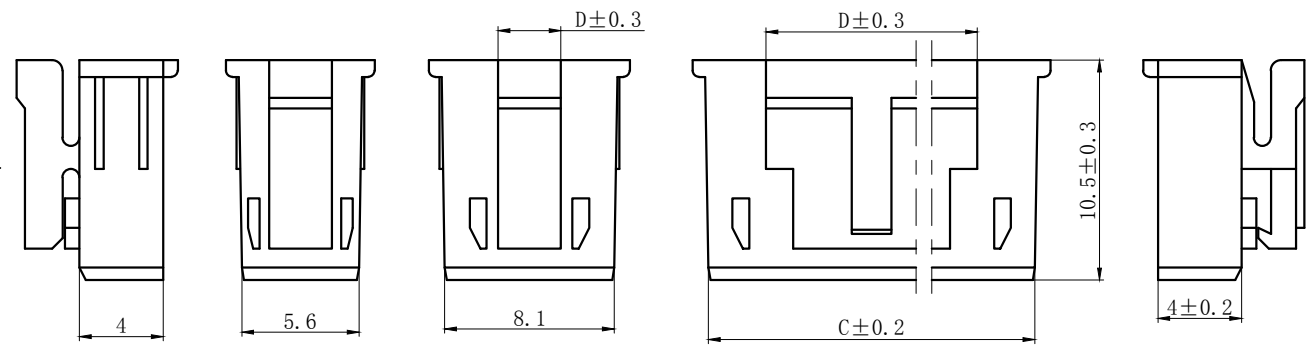

C
D

C
D

E
F

E
F

4-5PIN

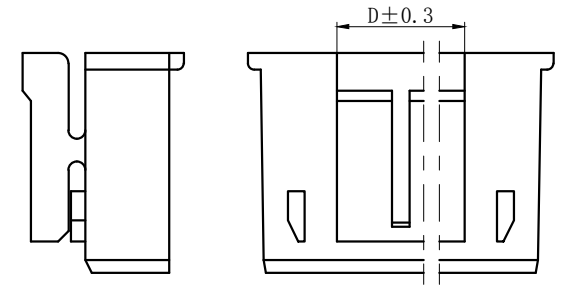

Circuits	Product name	Dimensino (mm)			
		A	B	C	D
2	TJC3B-H-2Y	2.5	7.0	5.6	3.0
3	TJC3B-H-3Y	5.0	9.5	8.1	3.0
4	TJC3B-H-4Y	7.5	12.0	10.6	5.0
5	TJC3B-H-5Y	10.0	14.5	13.1	6.0
6	TJC3B-H-6Y	12.5	17.0	15.6	10.0
7	TJC3B-H-7Y	15.0	19.5	18.1	11.0
8	TJC3B-H-8Y	17.5	22.0	20.6	12.0
9	TJC3B-H-9Y	20.0	24.5	23.1	13.0
10	TJC3B-H-10Y	22.5	27.0	25.6	14.0
11	TJC3B-H-11Y	25.0	29.5	28.1	15.0
12	TJC3B-H-12Y	27.5	32.0	30.6	16.0
13	TJC3B-H-13Y	30.0	34.5	33.1	17.0
14	TJC3B-H-14Y	32.5	37.0	35.6	18.0
15	TJC3B-H-15Y	35.0	39.5	38.1	19.0

GENERAL TOLERANCES (UNLESS SPECIFIED)		ZHE JIANG DELI CONNECTORS CO., LTD	
.X: ± 0.25	X°: ± 3.0°	PRODUCT NAME:	TITLE:
.XX: ± 0.15	.X°: ± 2.0°	DL25029 (TJC3B-H)-Y	2.50 mm Pitch Housing
.XXX: ± 0.01	.XX°: ± 1.0°	DR: Chen Quan Long	DATE: 18/03/01
FINISH:		CHKD: Wu Hui	DATE: 18/03/01
DRAWING NO:		APPD: Ren An De	DATE: 18/03/01
			PART NO:
			SCALE: N/A
			PAGE: 1/1
			UNITS: mm
			REV.: A

1 2 3 4 5 6 7 8

REV.	REVISION DESCRIPTION	DATE	APPD

NOTES

Available in 02 through 20 Circuits.
 Match with DL25001-Y series housing
 Material : Nylon UL94V-0(2).

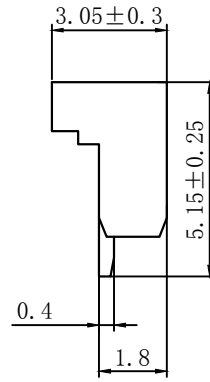
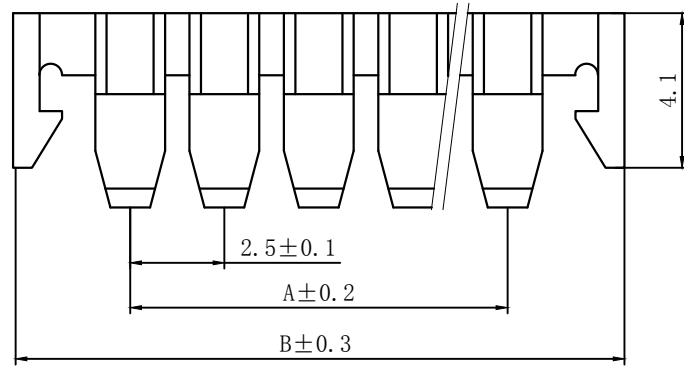
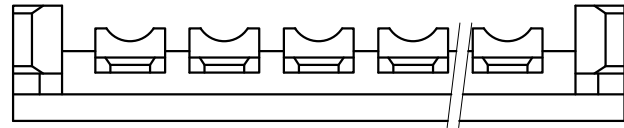

Circuits	Product name	Dimension mm		Circuits	Product name	Dimension mm	
		A	B			A	B
2	TJC3-2S	2.50	8.7	9	TJC3-9S	20.00	26.2
3	TJC3-3S	5.00	11.2	10	TJC3-10S	22.50	28.7
4	TJC3-4S	7.50	13.7	11	TJC3-11S	25.00	31.2
5	TJC3-5S	10.00	16.2	12	TJC3-12S	27.50	33.7
6	TJC3-6S	12.50	18.7	13	TJC3-13S	30.00	36.2
7	TJC3-7S	15.00	21.2	~	~	~	~
8	TJC3-8S	17.50	23.7	20	TJC3-20S	47.80	53.7

GENERAL TOLERANCES (UNLESS SPECIFIED)		ZHE JIANG DELI CONNECTORS CO., LTD			
.X: ± 0.25	X°: ± 3.0°	PRODUCT NAME: DL25001(TJC3)-S		TITLE: 2.50 mm Pitch Housing	
.XX: ± 0.15	.X°: ± 2.0°	DR: Yuan Jun Rong	DATE:21/03/18	PART NO:	
.XXX: ± 0.01	.XX°: ± 1.0°	CHKD: Wu Hui	DATE:21/03/18	SCALE: N/A	PAGE: 1/1
FINISH:		APPD: Ren An De	DATE:21/03/18	UNITS: mm	REV.: A
DRAWING NO:					

REV.	REVISION DESCRIPTION	DATE	APPD

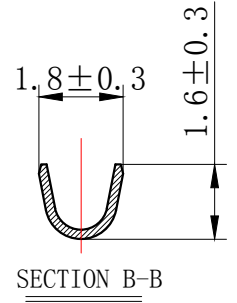
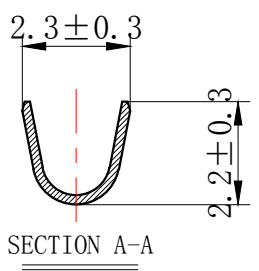
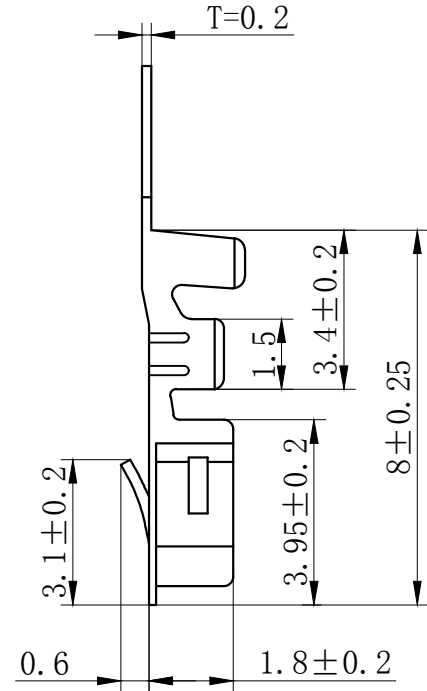
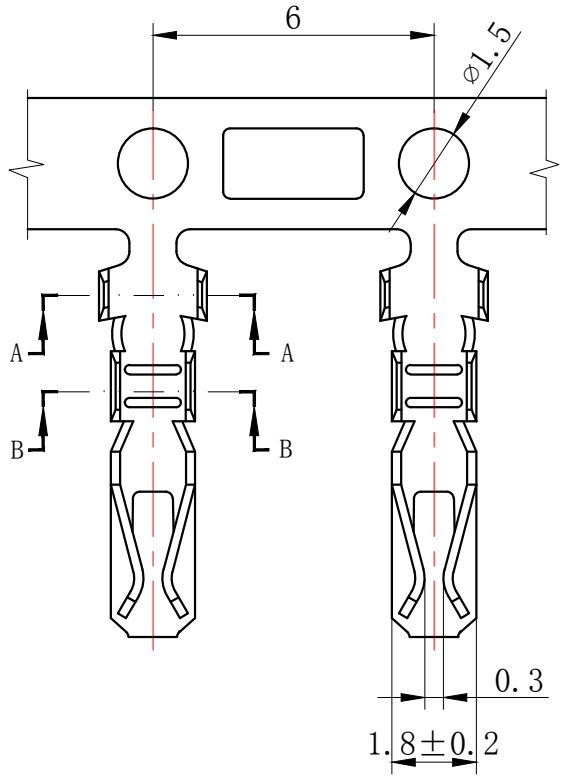

NOTES

Used in DL25029-Y Series Housing.
 Accepts AWG #28~22 Wire Range.
 Insulation O.D. = 1.2~1.9 mm.
 Material : Phosphor Bronze .
 Finish: Tin plated.
 Thickness: 0.2 mm.

GENERAL TOLERANCES (UNLESS SPECIFIED)		ZHE JIANG DELI CONNECTORS CO., LTD	
.X: ± 0.25	X°: ± 3.0°	PRODUCT NAME:	TITLE:
.XX: ± 0.15	.X°: ± 2.0°	DL25029(TJC3B-H)-T	2.50 mm Pitch Crimp Terminal
.XXX: ± 0.01	.XX°: ± 1.0°	DR: Chen Quan Long	DATE: 18/03/19
FINISH:		CHKD: Wu Hui	DATE: 18/03/19
DRAWING NO:		APPD: Ren An De	DATE: 18/03/19
			PART NO:
			SCALE: N/A
			PAGE: 1/1
			UNITS: mm
			REV.: A

X-ON Electronics

Largest Supplier of Electrical and Electronic Components

Click to view similar products for [Headers & Wire Housings](#) category:

Click to view products by [DLL](#) manufacturer:

Other Similar products are found below :

[0015917161](#) [0022155065](#) [57102-F02-18ULF](#) [58102-G61-06LF](#) [582553-1](#) [01.001.5753.1](#) [0050291907](#) [02.125.8002.8](#) [609-3404](#) [61062-3](#)
[CSU011177004](#) [622-0430](#) [622-3653LF](#) [63453-116](#) [636-1030](#) [636-1427](#) [636-3427](#) [636-4007](#) [641938-9](#) [65495-038](#) [65692-001LF](#) [65781-018](#)
[65781-047](#) [65817-010LF](#) [65817-015LF](#) [67095-007LF](#) [67601157](#) [68631-112](#) [68645-018](#) [699319-000](#) [70.362.1628.0](#) [70-4210](#) [70-4226B](#) [70-](#)
[4853B](#) [71.350.2428.0](#) [733-134](#) [733-162](#) [760-3052](#) [MHR-64-VUAL](#) [80.063.4001.1](#) [800-90-001-10-001000](#) [801-43-002-10-013000](#)
[801-43-006-10-002000](#) [803-43-024-10-001000](#) [803-93-012-10-001000](#) [8-1437020-4](#) [819-22-004-30-001101](#) [820-22-006-30-001101](#)
[820-22-008-30-001101](#) [821-22-002-10-001101](#)