



技术特性/Specifications:

额定电压 Rated voltage: 250V AC, DC
额定电流 Rated current: 3A AC, DC
接触电阻 Contact resistance: 20m Ω max
绝缘电阻 Insulation resistance: 1000M Ω min
耐压 Withstand voltage: 1000V AC/minute
环境温度 Ambient temperature: -40 $^{\circ}$ C~+105 $^{\circ}$ C
适用线规 Wire range: AWG#28~#22

| | | | |
|------|----------------------|------|------|
| REV. | REVISION DESCRIPTION | DATE | APPD |
| | | | |



NOTES

Available in 02 through 15 Circuits.
 Mates with DL25002-Y Series Housing.
 Material : Nylon UL94V-0(2).
 0.64mm Square Pin.
 Pin Material : Brass / Tin-Plated.

| Circuits | Product name | Dimension mm | | | Circuits | Product name | Dimension mm | | |
|----------|-----------------|--------------|-------|-------|----------|------------------|--------------|-------|-------|
| | | A | B | C | | | A | B | C |
| 2 | TJC3B-H-2A-11.2 | 2.50 | 7.50 | 5.70 | 10 | TJC3B-H-10A-11.2 | 22.50 | 27.50 | 25.70 |
| 3 | TJC3B-H-3A-11.2 | 5.00 | 10.00 | 8.20 | 11 | TJC3B-H-11A-11.2 | 25.00 | 30.00 | 28.20 |
| 4 | TJC3B-H-4A-11.2 | 7.50 | 12.50 | 10.70 | 12 | TJC3B-H-12A-11.2 | 27.50 | 32.50 | 30.70 |
| 5 | TJC3B-H-5A-11.2 | 10.00 | 15.00 | 13.20 | 13 | TJC3B-H-13A-11.2 | 30.00 | 35.00 | 33.20 |
| 6 | TJC3B-H-6A-11.2 | 12.50 | 17.50 | 15.70 | 14 | TJC3B-H-14A-11.2 | 32.50 | 37.50 | 35.70 |
| 7 | TJC3B-H-7A-11.2 | 15.00 | 20.00 | 18.20 | 15 | TJC3B-H-15A-11.2 | 35.00 | 40.00 | 38.20 |
| 8 | TJC3B-H-8A-11.2 | 17.50 | 22.50 | 20.70 | - | - | - | - | - |
| 9 | TJC3B-H-9A-11.2 | 20.00 | 25.00 | 23.20 | - | - | - | - | - |

| | | | | | |
|---------------------------------------|--------------|---|---------------|--|-----------|
| GENERAL TOLERANCES (UNLESS SPECIFIED) | | ZHE JIANG DELI CONNECTORS CO., LTD | | | |
| .X: ± 0.25 | X°: ± 3.0° | PRODUCT NAME: DL25029(TJC3B-H)-A-11.2 | | TITLE: 2.50 mm Pitch Wire To Board Wafer | |
| .XX: ± 0.15 | .X°: ± 2.0° | DR:Chen Quan Long | DATE:18/03/01 | PART NO: | |
| .XXX: ± 0.01 | .XX°: ± 1.0° | CHKD: Wu Hui | DATE:18/03/01 | SCALE: N/A | PAGE: 1/1 |
| DRAWING NO: | | APPD:Ren An De | DATE:18/03/01 | UNITS: mm | REV.: A |

| | | | |
|------|----------------------|------|------|
| REV. | REVISION DESCRIPTION | DATE | APPD |
| | | | |

NOTES

Available in 02 through 15 Circuits.
Mates with DL25002-Y Series Housing.
Material : Nylon UL94V-0(2).
0.64mm Square Pin.
Pin Material : Brass / Tin-Plated.

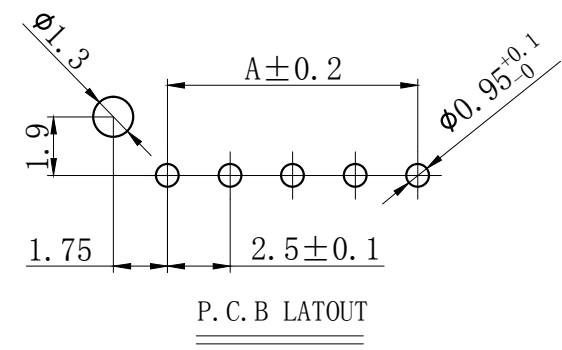
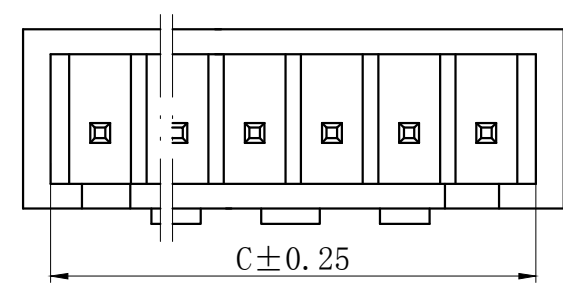
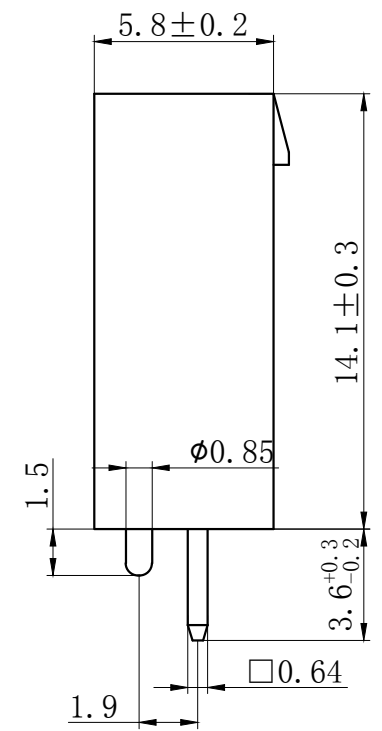
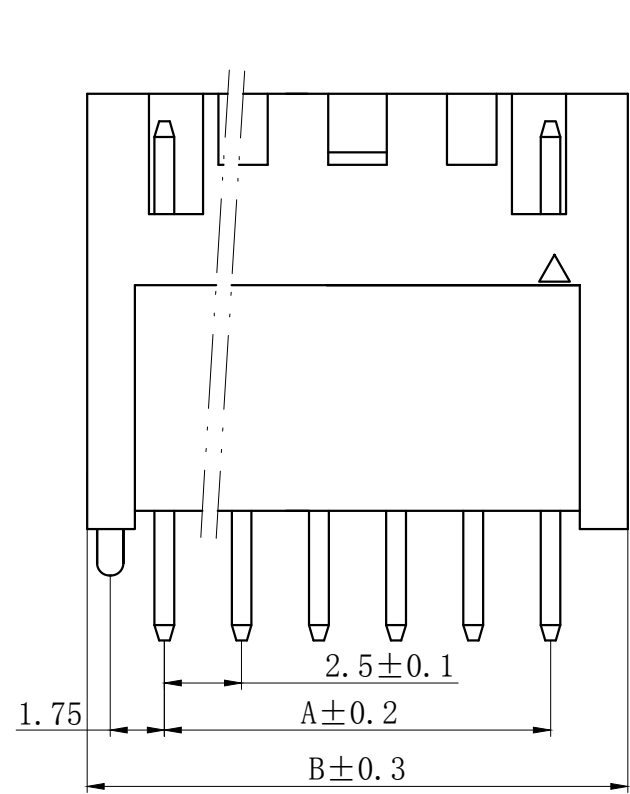

| Circuits | Product name | Dimension mm | | | Circuits | Product name | Dimension mm | | |
|----------|--------------|--------------|-------|-------|----------|--------------|--------------|-------|-------|
| | | A | B | C | | | A | B | C |
| 2 | TJC3B-H-2AS | 2.50 | 7.50 | 5.70 | 10 | TJC3B-H-10AS | 22.50 | 27.50 | 25.70 |
| 3 | TJC3B-H-3AS | 5.00 | 10.00 | 8.20 | 11 | TJC3B-H-11AS | 25.00 | 30.00 | 28.20 |
| 4 | TJC3B-H-4AS | 7.50 | 12.50 | 10.70 | 12 | TJC3B-H-12AS | 27.50 | 32.50 | 30.70 |
| 5 | TJC3B-H-5AS | 10.00 | 15.00 | 13.20 | 13 | TJC3B-H-13AS | 30.00 | 35.00 | 33.20 |
| 6 | TJC3B-H-6AS | 12.50 | 17.50 | 15.70 | 14 | TJC3B-H-14AS | 32.50 | 37.50 | 35.70 |
| 7 | TJC3B-H-7AS | 15.00 | 20.00 | 18.20 | 15 | TJC3B-H-15AS | 35.00 | 40.00 | 38.20 |
| 8 | TJC3B-H-8AS | 17.50 | 22.50 | 20.70 | - | - | - | - | - |
| 9 | TJC3B-H-9AS | 20.00 | 25.00 | 23.20 | - | - | - | - | - |

| | | | | | |
|---------------------------------------|--------------|---------------------------------------|----------------|--|-----------|
| GENERAL TOLERANCES (UNLESS SPECIFIED) | | ZHE JIANG DELI CONNECTORS CO., LTD | | | |
| .X: ± 0.25 | X°: ± 3.0° | PRODUCT NAME: DL25029 (TJC3B-H)-AS | | TITLE: 2.50 mm Pitch Wire To Board Wafer | |
| .XX: ± 0.15 | .X°: ± 2.0° | DR: Chen Quan Long | DATE: 18/03/01 | PART NO: | |
| .XXX: ± 0.01 | .XX°: ± 1.0° | CHKD: Wu Hui | DATE: 18/03/01 | SCALE: N/A | PAGE: 1/1 |
| DRAWING NO: | | APPD: Ren An De | DATE: 18/03/01 | UNITS: mm | REV.: A |

| | | | |
|------|----------------------|------|------|
| REV. | REVISION DESCRIPTION | DATE | APPD |
| | | | |

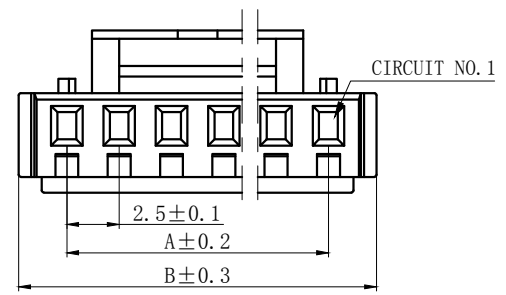

NOTES

Available in 02 through 15 Circuits.
 Match with DL25029 series housing
 Material : Nylon UL94V-0(2).
 Accepts DL25029-T Crimp Terminal.

2-3PIN

6PIN以上

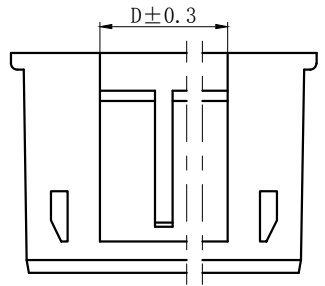
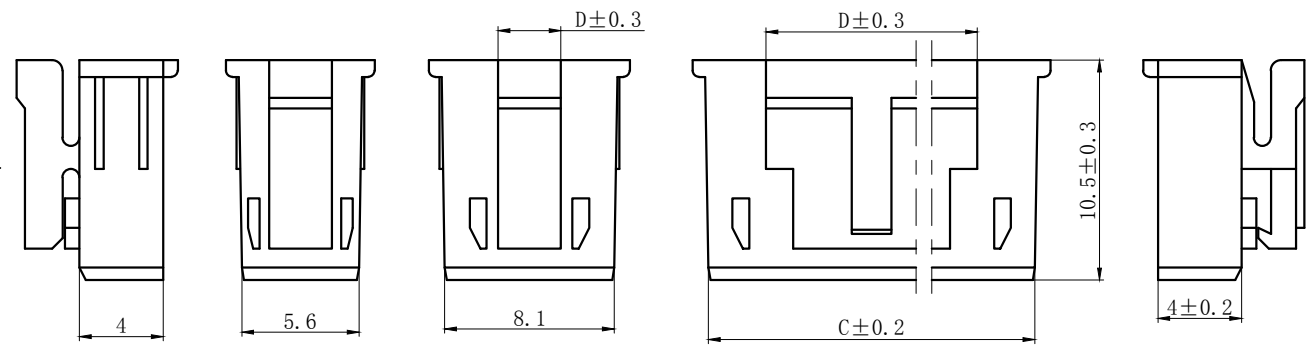

4-5PIN

| Circuits | Product name | Dimensino (mm) | | | |
|----------|--------------|----------------|------|------|------|
| | | A | B | C | D |
| 2 | TJC3B-H-2Y | 2.5 | 7.0 | 5.6 | 3.0 |
| 3 | TJC3B-H-3Y | 5.0 | 9.5 | 8.1 | 3.0 |
| 4 | TJC3B-H-4Y | 7.5 | 12.0 | 10.6 | 5.0 |
| 5 | TJC3B-H-5Y | 10.0 | 14.5 | 13.1 | 6.0 |
| 6 | TJC3B-H-6Y | 12.5 | 17.0 | 15.6 | 10.0 |
| 7 | TJC3B-H-7Y | 15.0 | 19.5 | 18.1 | 11.0 |
| 8 | TJC3B-H-8Y | 17.5 | 22.0 | 20.6 | 12.0 |
| 9 | TJC3B-H-9Y | 20.0 | 24.5 | 23.1 | 13.0 |
| 10 | TJC3B-H-10Y | 22.5 | 27.0 | 25.6 | 14.0 |
| 11 | TJC3B-H-11Y | 25.0 | 29.5 | 28.1 | 15.0 |
| 12 | TJC3B-H-12Y | 27.5 | 32.0 | 30.6 | 16.0 |
| 13 | TJC3B-H-13Y | 30.0 | 34.5 | 33.1 | 17.0 |
| 14 | TJC3B-H-14Y | 32.5 | 37.0 | 35.6 | 18.0 |
| 15 | TJC3B-H-15Y | 35.0 | 39.5 | 38.1 | 19.0 |

| | | | |
|---------------------------------------|--------------|------------------------------------|-----------------------|
| GENERAL TOLERANCES (UNLESS SPECIFIED) | | ZHE JIANG DELI CONNECTORS CO., LTD | |
| .X: ± 0.25 | X°: ± 3.0° | PRODUCT NAME: | TITLE: |
| .XX: ± 0.15 | .X°: ± 2.0° | DL25029 (TJC3B-H)-Y | 2.50 mm Pitch Housing |
| .XXX: ± 0.01 | .XX°: ± 1.0° | DR: Chen Quan Long | DATE: 18/03/01 |
| FINISH: | | CHKD: Wu Hui | DATE: 18/03/01 |
| DRAWING NO: | | APPD: Ren An De | DATE: 18/03/01 |
| | | | PART NO: |
| | | | SCALE: N/A |
| | | | PAGE: 1/1 |
| | | | UNITS: mm |
| | | | REV.: A |

| | | | |
|------|----------------------|------|------|
| REV. | REVISION DESCRIPTION | DATE | APPD |
| | | | |

NOTES

Available in 02 through 20 Circuits.
 Match with DL25001-Y series housing
 Material : Nylon UL94V-0(2).

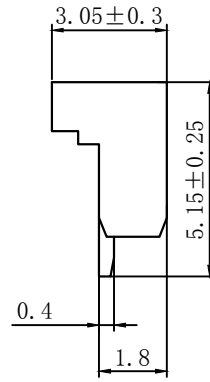
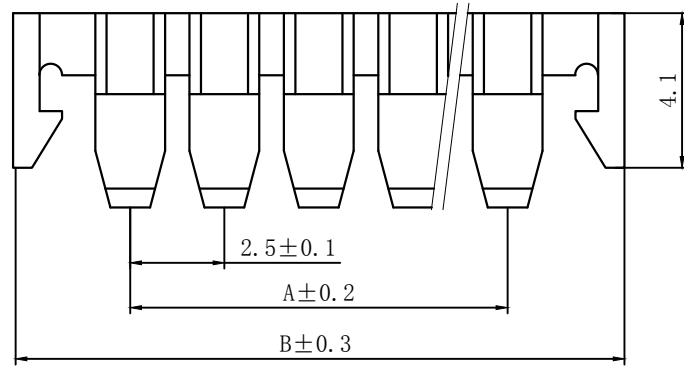
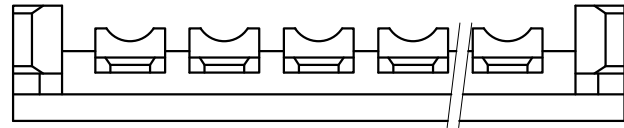

| Circuits | Product name | Dimension mm | | Circuits | Product name | Dimension mm | |
|----------|--------------|--------------|------|----------|--------------|--------------|------|
| | | A | B | | | A | B |
| 2 | TJC3-2S | 2.50 | 8.7 | 9 | TJC3-9S | 20.00 | 26.2 |
| 3 | TJC3-3S | 5.00 | 11.2 | 10 | TJC3-10S | 22.50 | 28.7 |
| 4 | TJC3-4S | 7.50 | 13.7 | 11 | TJC3-11S | 25.00 | 31.2 |
| 5 | TJC3-5S | 10.00 | 16.2 | 12 | TJC3-12S | 27.50 | 33.7 |
| 6 | TJC3-6S | 12.50 | 18.7 | 13 | TJC3-13S | 30.00 | 36.2 |
| 7 | TJC3-7S | 15.00 | 21.2 | ~ | ~ | ~ | ~ |
| 8 | TJC3-8S | 17.50 | 23.7 | 20 | TJC3-20S | 47.80 | 53.7 |

| | | | | | |
|--|--------------|------------------------------------|---------------|---------------------------------|-----------|
| GENERAL TOLERANCES (UNLESS SPECIFIED) | | ZHE JIANG DELI CONNECTORS CO., LTD | | | |
| .X: ± 0.25 | X°: ± 3.0° | PRODUCT NAME: DL25001(TJC3)-S | | TITLE: 2.50 mm Pitch Housing | |
| .XX: ± 0.15 | .X°: ± 2.0° | DR: Yuan Jun Rong | DATE:21/03/18 | PART NO: | |
| .XXX: ± 0.01 | .XX°: ± 1.0° | CHKD: Wu Hui | DATE:21/03/18 | SCALE: N/A | PAGE: 1/1 |
| FINISH: | | APPD: Ren An De | DATE:21/03/18 | UNITS: mm | REV.: A |
| DRAWING NO: | | | | | |

| REV. | REVISION DESCRIPTION | DATE | APPD |
|------|----------------------|------|------|
| | | | |

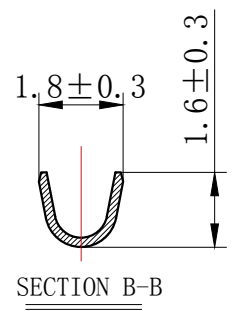
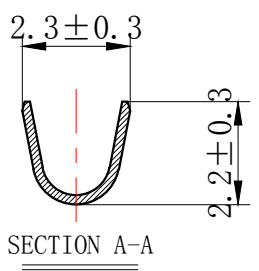
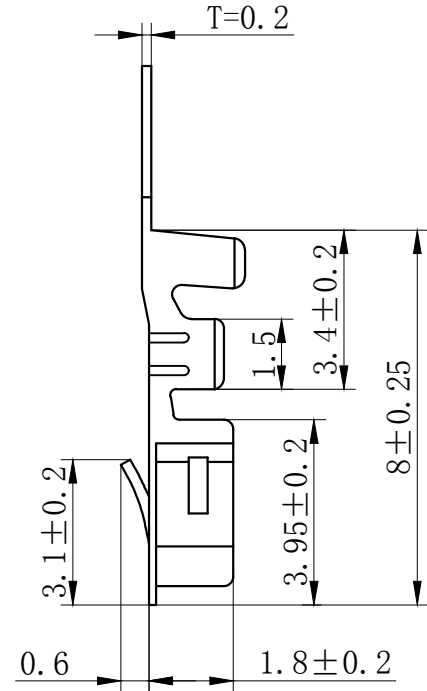
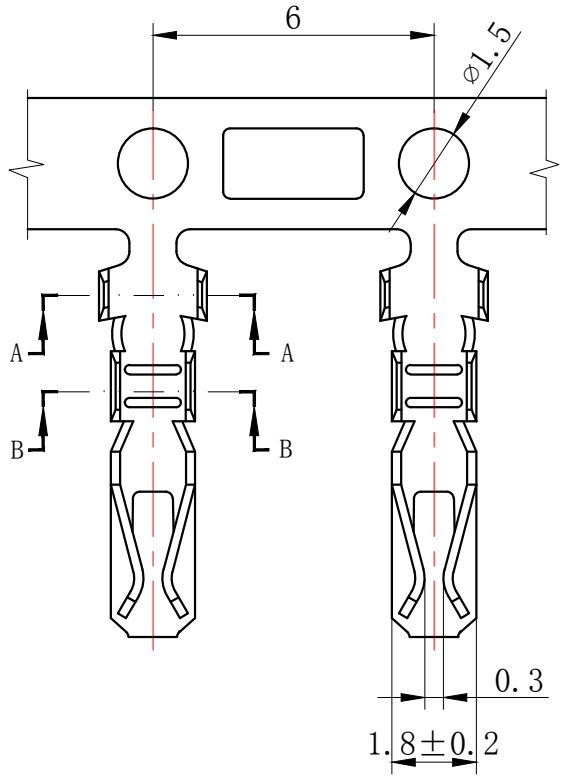

NOTES

Used in DL25029-Y Series Housing.
 Accepts AWG #28~22 Wire Range.
 Insulation O.D. = 1.2~1.9 mm.
 Material : Phosphor Bronze .
 Finish: Tin plated.
 Thickness: 0.2 mm.

| GENERAL TOLERANCES (UNLESS SPECIFIED) | | ZHE JIANG DELI CONNECTORS CO., LTD | | |
|--|--------------|------------------------------------|---------------------------------|-----------|
| .X: ± 0.25 | X°: ± 3.0° | PRODUCT NAME: | TITLE: | |
| .XX: ± 0.15 | .X°: ± 2.0° | DL25029(TJC3B-H)-T | 2.50 mm Pitch Crimp Terminal | |
| .XXX: ± 0.01 | .XX°: ± 1.0° | DR: Chen Quan Long | DATE: 18/03/19 | |
| FINISH: | | CHKD: Wu Hui | DATE: 18/03/19 | |
| DRAWING NO: | | APPD: Ren An De | DATE: 18/03/19 | |
| | | | PART NO: | |
| | | | SCALE: N/A | PAGE: 1/1 |
| | | | UNITS: mm | REV.: A |

X-ON Electronics

Largest Supplier of Electrical and Electronic Components

Click to view similar products for [Headers & Wire Housings](#) category:

Click to view products by [DLL](#) manufacturer:

Other Similar products are found below :

[0015917161](#) [0022155065](#) [57102-F02-18ULF](#) [58102-G61-06LF](#) [582553-1](#) [01.001.5753.1](#) [0050291907](#) [02.125.8002.8](#) [609-3404](#) [61062-3](#)
[CSU011177004](#) [622-0430](#) [622-3653LF](#) [63453-116](#) [636-1030](#) [636-1427](#) [636-3427](#) [636-4007](#) [641938-9](#) [65495-038](#) [65692-001LF](#) [65781-018](#)
[65781-047](#) [65817-010LF](#) [65817-015LF](#) [67095-007LF](#) [67601157](#) [68631-112](#) [68645-018](#) [699319-000](#) [70.362.1628.0](#) [70-4210](#) [70-4226B](#) [70-](#)
[4853B](#) [71.350.2428.0](#) [733-134](#) [733-162](#) [760-3052](#) [MHR-64-VUAL](#) [80.063.4001.1](#) [800-90-001-10-001000](#) [801-43-002-10-013000](#)
[801-43-006-10-002000](#) [803-43-024-10-001000](#) [803-93-012-10-001000](#) [8-1437020-4](#) [819-22-004-30-001101](#) [820-22-006-30-001101](#)
[820-22-008-30-001101](#) [821-22-002-10-001101](#)