

技术特性/Specifications:

额定电压 Rated voltage: 250V AC, DC
额定电流 Rated current: 3A AC, DC
接触电阻 Contact resistance: 20m Ω max
绝缘电阻 Insulation resistance: 1000M Ω min
耐压 Withstand voltage: 1000V AC/minute
环境温度 Ambient temperature: -40 $^{\circ}$ C~+105 $^{\circ}$ C
适用线规 Wire range: AWG#28~#22

| | | | |
|------|----------------------|------|------|
| REV. | REVISION DESCRIPTION | DATE | APPD |
| | | | |

NOTES

Available in 02 through 20 Circuits.
Mates with DL25003-Y Series Housing.

Material : Nylon UL94V-0(2).

0.64mm Square Pin.

Pin Material : Brass / Tin-Plated.

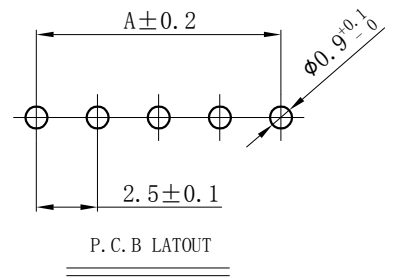
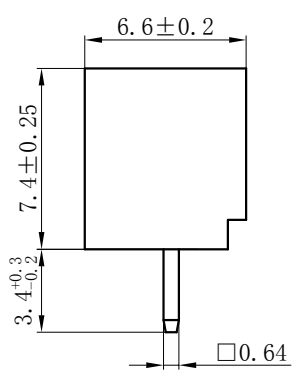
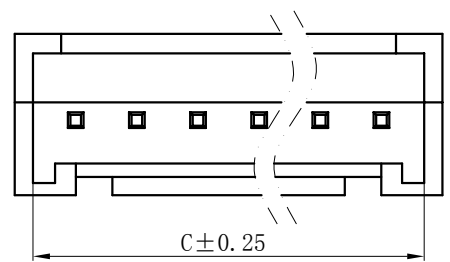
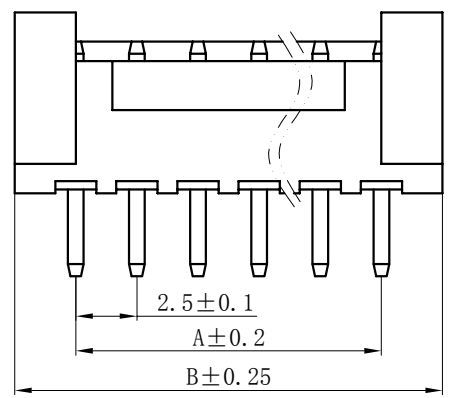
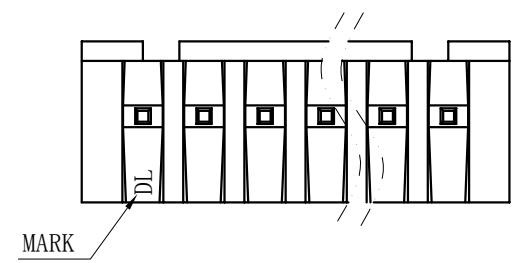

| Circuits | Product name | Dimension mm | | | Circuits | Product name | Dimension mm | | |
|----------|--------------|--------------|-------|-------|----------|--------------|--------------|-------|-------|
| | | A | B | C | | | A | B | C |
| 2 | TJC3C-2A | 2.50 | 7.50 | 6.00 | 10 | TJC3C-10A | 22.50 | 27.50 | 26.00 |
| 3 | TJC3C-3A | 5.00 | 10.00 | 8.50 | 11 | TJC3C-11A | 25.00 | 30.00 | 28.50 |
| 4 | TJC3C-4A | 7.50 | 12.50 | 11.00 | 12 | TJC3C-12A | 27.50 | 32.50 | 31.00 |
| 5 | TJC3C-5A | 10.00 | 15.00 | 13.50 | 13 | TJC3C-13A | 30.00 | 35.00 | 33.50 |
| 6 | TJC3C-6A | 12.50 | 17.50 | 16.00 | 14 | TJC3C-14A | 32.50 | 37.50 | 36.00 |
| 7 | TJC3C-7A | 15.00 | 20.00 | 18.50 | 15 | TJC3C-15A | 35.00 | 40.00 | 38.50 |
| 8 | TJC3C-8A | 17.50 | 22.50 | 21.00 | - | - | - | - | - |
| 9 | TJC3C-9A | 20.00 | 25.00 | 23.50 | 20 | TJC3C-20A | 47.50 | 52.50 | 51.00 |

| | | | | | |
|---------------------------------------|---------------|------------------------------------|----------------|--|-----------|
| GENERAL TOLERANCES (UNLESS SPECIFIED) | | ZHE JIANG DELI CONNECTORS CO., LTD | | | |
| .X: ± 0.25 | .X°: ± 3.0° | PRODUCT NAME: DL25003(TJC3C)-A | | TITLE: 2.50 mm Pitch Wire To Board Wafer | |
| .XX: ± 0.15 | .XX°: ± 2.0° | DR: Chen Quan Long | DATE: 19/08/01 | PART NO: | |
| .XXX: ± 0.01 | .XXX°: ± 1.0° | CHKD: Wu Hui | DATE: 19/08/01 | SCALE: N/A | PAGE: 1/1 |
| FINISH: | | APPD: Ren An De | DATE: 19/08/01 | UNITS: mm | REV.: A |
| DRAWING NO: | | | | | |

| REV. | REVISION DESCRIPTION | DATE | APPD |
|------|----------------------|------|------|
| | | | |

NOTES

Available in 02 through 20 Circuits.
Mates with DL25003-Y Series Housing.

Material : Nylon UL94V-0(2).

0.64mm Square Pin.

Pin Material : Brass / Tin-Plated.

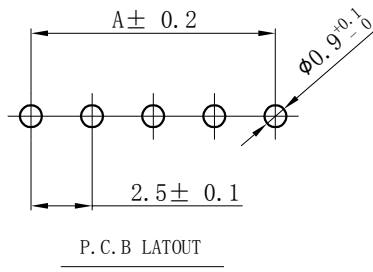
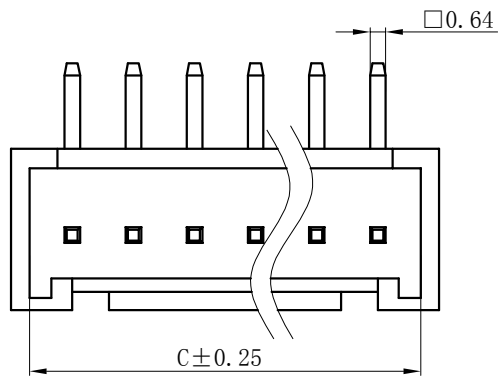
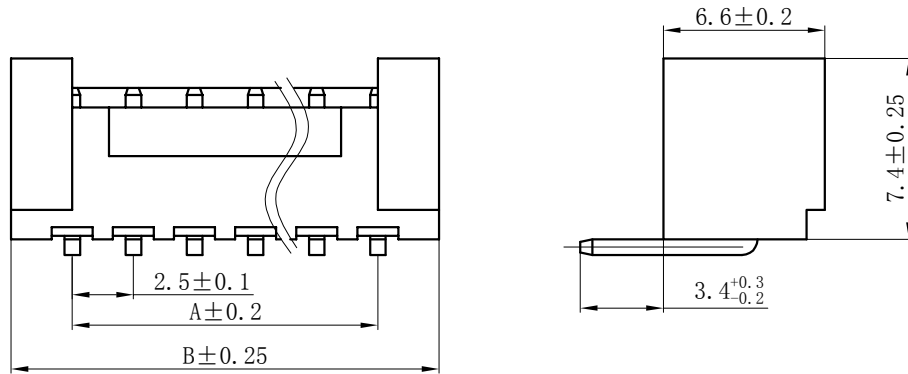

| Circuits | Product name | Dimension mm | | | Circuits | Product name | Dimension mm | | |
|----------|--------------|--------------|-------|-------|----------|--------------|--------------|-------|-------|
| | | A | B | C | | | A | B | C |
| 2 | TJC3C-2AW | 2.50 | 7.50 | 6.00 | 10 | TJC3C-10AW | 22.50 | 27.50 | 26.00 |
| 3 | TJC3C-3AW | 5.00 | 10.00 | 8.50 | 11 | TJC3C-11AW | 25.00 | 30.00 | 28.50 |
| 4 | TJC3C-4AW | 7.50 | 12.50 | 11.00 | 12 | TJC3C-12AW | 27.50 | 32.50 | 31.00 |
| 5 | TJC3C-5AW | 10.00 | 15.00 | 13.50 | 13 | TJC3C-13AW | 30.00 | 35.00 | 33.50 |
| 6 | TJC3C-6AW | 12.50 | 17.50 | 16.00 | 14 | TJC3C-14AW | 32.50 | 37.50 | 36.00 |
| 7 | TJC3C-7AW | 15.00 | 20.00 | 18.50 | 15 | TJC3C-15AW | 35.00 | 40.00 | 38.50 |
| 8 | TJC3C-8AW | 17.50 | 22.50 | 21.00 | - | - | - | - | - |
| 9 | TJC3C-9AW | 20.00 | 25.00 | 23.50 | 20 | TJC3C-20AW | 47.50 | 52.50 | 51.00 |

| GENERAL TOLERANCES (UNLESS SPECIFIED) | | ZHE JIANG DELI CONNECTORS CO., LTD | | | |
|---------------------------------------|--------------|------------------------------------|----------------|--|-----------|
| .X: ± 0.25 | X°: ± 3.0° | PRODUCT NAME: DL25003(TJC3C)-AW | | TITLE: 2.50 mm Pitch Wire To Board Wafer | |
| .XX: ± 0.15 | .X°: ± 2.0° | DR: Chen Quan Long | DATE: 19/08/01 | PART NO: | |
| .XXX: ± 0.01 | .XX°: ± 1.0° | CHKD: Wu Hui | DATE: 19/08/01 | SCALE: N/A | PAGE: 1/1 |
| FINISH: | | APPD: Ren An De | DATE: 19/08/01 | UNITS: mm | REV.: A |
| DRAWING NO: | | | | | |

| REV. | REVISION DESCRIPTION | DATE | APPD |
|------|----------------------|------|------|
| | | | |

NOTES

Available in 02 through 20 Circuits.
 Mates with DL25003 Series Housing.
 Material : Nylon UL94-V0(2).
 Accepts DL25003-T Crimp Terminal.

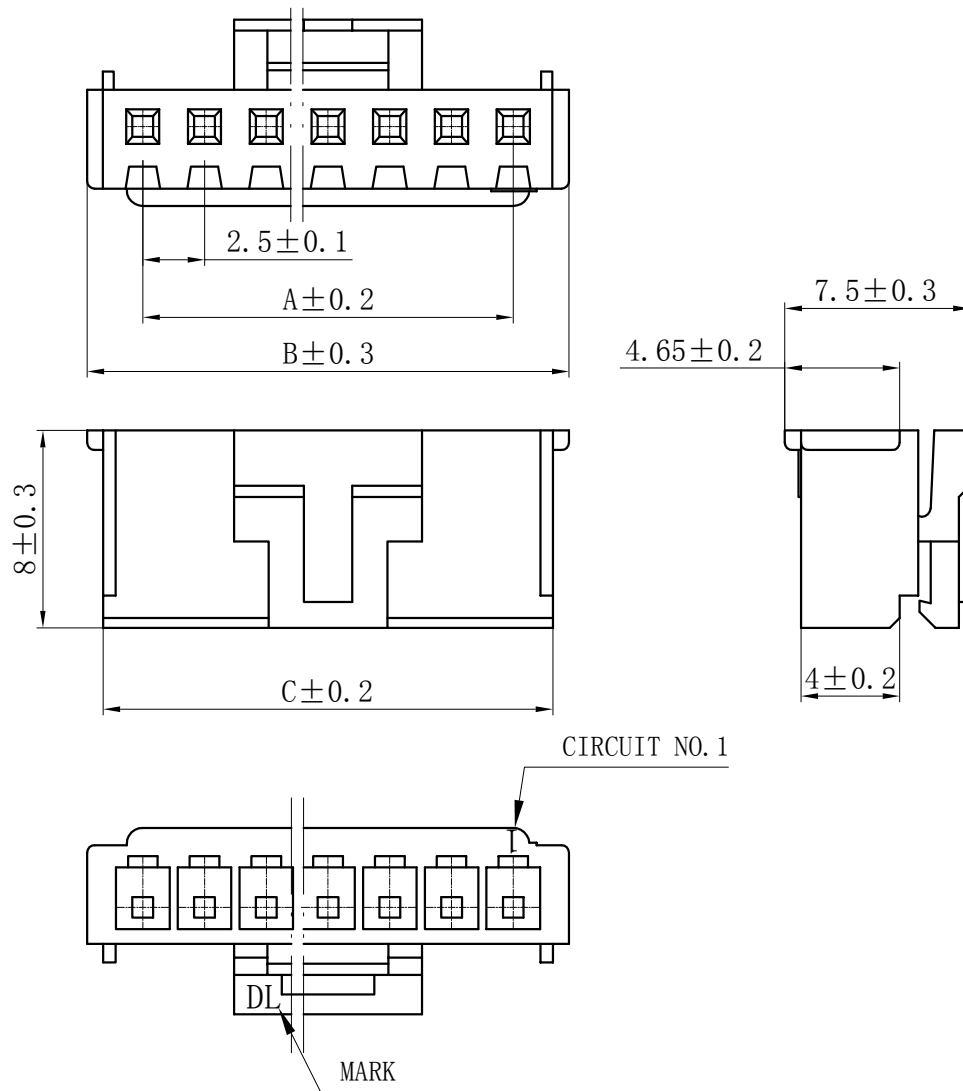

| Circuits | Product name | Dimension mm | | | Circuits | Product name | Dimension mm | | |
|----------|--------------|--------------|-------|-------|----------|--------------|--------------|-------|-------|
| | | A | B | C | | | A | B | C |
| 2 | TJC3C-2Y | 2.50 | 7.10 | 5.80 | 9 | TJC3C-9Y | 20.00 | 24.60 | 23.30 |
| 3 | TJC3C-3Y | 5.00 | 9.60 | 8.30 | 10 | TJC3C-10Y | 22.50 | 27.10 | 25.80 |
| 4 | TJC3C-4Y | 7.50 | 12.10 | 10.80 | 11 | TJC3C-11Y | 25.00 | 29.60 | 28.30 |
| 5 | TJC3C-5Y | 10.00 | 14.60 | 13.30 | 12 | TJC3C-12Y | 27.50 | 32.10 | 30.80 |
| 6 | TJC3C-6Y | 12.50 | 17.10 | 15.80 | 13 | TJC3C-13Y | 30.00 | 34.60 | 33.30 |
| 7 | TJC3C-7Y | 15.00 | 19.60 | 18.30 | ~ | ~ | ~ | ~ | ~ |
| 8 | TJC3C-8Y | 17.50 | 22.10 | 20.80 | 20 | TJC3C-20Y | 47.50 | 52.10 | 50.80 |

| GENERAL TOLERANCES (UNLESS SPECIFIED) | | ZHE JIANG DELI CONNECTORS CO., LTD | | | |
|---------------------------------------|-----------------------|--|----------------|---------------------------------|-----------|
| .X: ± 0.25 | X°: $\pm 3.0^\circ$ | PRODUCT NAME: DL25003 (TJC3C) -Y | | TITLE: 2.50 mm Pitch Housing | |
| .XX: ± 0.15 | .X°: $\pm 2.0^\circ$ | DR: Chen Quan Long | DATE: 19/08/01 | PART NO: | |
| .XXX: ± 0.01 | .XX°: $\pm 1.0^\circ$ | CHKD: Wu Hui | DATE: 19/08/01 | SCALE: N/A | PAGE: 1/1 |
| FINISH: | | APPD: Ren An De | DATE: 19/08/01 | UNITS: mm | REV.: A |
| DRAWING NO: | | | | | |

| REV. | REVISION DESCRIPTION | DATE | APPD |
|------|----------------------|------|------|
| | | | |

NOTES

Available in 02 through 20 Circuits.
 Match with DL25001-Y series housing
 Material : Nylon UL94V-0(2).

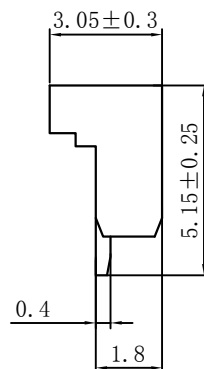
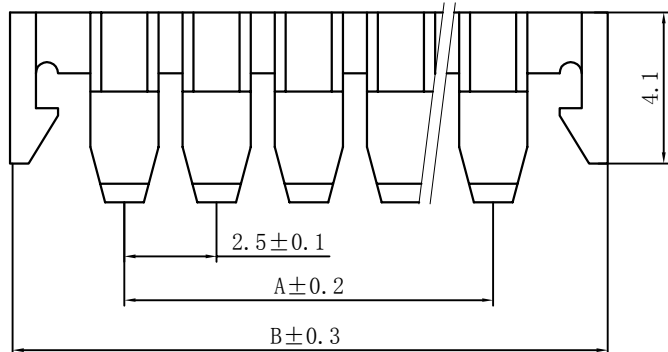
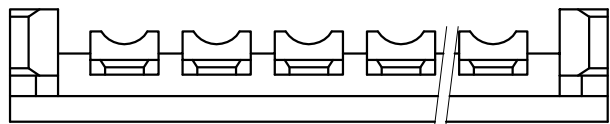

| Circuits | Product name | Dimension mm | | Circuits | Product name | Dimension mm | |
|----------|--------------|--------------|------|----------|--------------|--------------|------|
| | | A | B | | | A | B |
| 2 | TJC3-2S | 2.50 | 8.7 | 9 | TJC3-9S | 20.00 | 26.2 |
| 3 | TJC3-3S | 5.00 | 11.2 | 10 | TJC3-10S | 22.50 | 28.7 |
| 4 | TJC3-4S | 7.50 | 13.7 | 11 | TJC3-11S | 25.00 | 31.2 |
| 5 | TJC3-5S | 10.00 | 16.2 | 12 | TJC3-12S | 27.50 | 33.7 |
| 6 | TJC3-6S | 12.50 | 18.7 | 13 | TJC3-13S | 30.00 | 36.2 |
| 7 | TJC3-7S | 15.00 | 21.2 | ~ | ~ | ~ | ~ |
| 8 | TJC3-8S | 17.50 | 23.7 | 20 | TJC3-20S | 47.80 | 53.7 |

| GENERAL TOLERANCES (UNLESS SPECIFIED) | | ZHE JIANG DELI CONNECTORS CO., LTD | | | |
|--|--------------|--|----------------|---------------------------------|-----------|
| .X: ± 0.25 | X°: ± 3.0° | PRODUCT NAME: DL25001 (TJC3)-S | | TITLE: 2.50 mm Pitch Housing | |
| .XX: ± 0.15 | .X°: ± 2.0° | DR: Yuan Jun Rong | DATE: 21/03/18 | PART NO: | |
| .XXX: ± 0.01 | .XX°: ± 1.0° | CHKD: Wu Hui | DATE: 21/03/18 | SCALE: N/A | PAGE: 1/1 |
| FINISH: | | APPD: Ren An De | DATE: 21/03/18 | UNITS: mm | REV.: A |
| DRAWING NO: | | | | | |

| REV. | REVISION DESCRIPTION | DATE | APPD |
|------|----------------------|------|------|
| | | | |

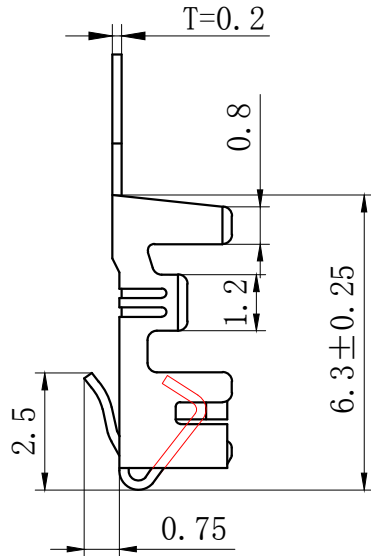
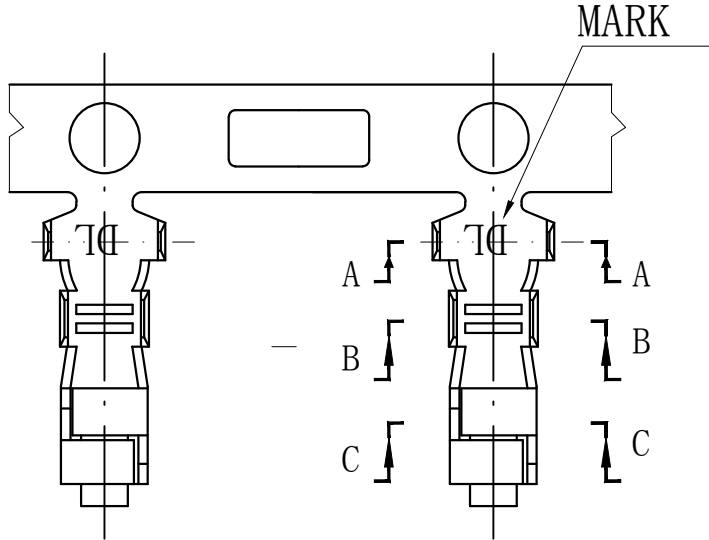

NOTES

Used in DL25001-Y Series Housing.
 Accepts AWG #28~22 Wire Range.
 0.08~ 0.33 mm² .
 Insulation O.D.=1.2~1.9 mm.
 Material : Phosphor Bronze .
 Finish: Tin plated.
 Thickness: 0.2 mm.

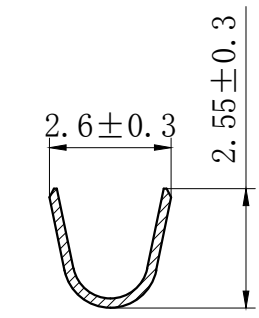

SECTION A-A

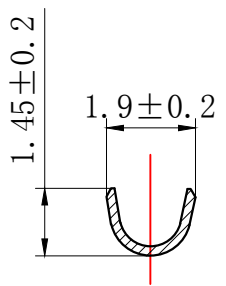

SECTION B-B

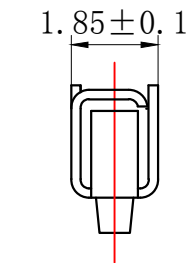

SECTION C-C

| GENERAL TOLERANCES (UNLESS SPECIFIED) | | ZHE JIANG DELI CONNECTORS CO.,LTD | |
|--|---------------|--|---|
| .X: ± 0.25 | X° : ± 3.0° | PRODUCT NAME: DL25001 (TJC3)-T | TITLE: 2.50 mm Pitch Crimp Terminal |
| .XX: ± 0.15 | .X° : ± 2.0° | DR:Chen Quan Long | DATE:19/08/01 |
| .XXX: ± 0.01 | .XX° : ± 1.0° | CHKD: Wu Hui | DATE:19/08/01 |
| FINISH: _____ | | APPD:Ren An De | DATE:19/08/01 |
| DRAWING NO: | | | |

A
B
C
D
E
F

A
B
C
D
E
F

1 2 3 4 5 6 7 8

1 2 3 4 5 6 7 8

X-ON Electronics

Largest Supplier of Electrical and Electronic Components

Click to view similar products for [Headers & Wire Housings](#) category:

Click to view products by [DLL](#) manufacturer:

Other Similar products are found below :

[0015917161](#) [0022155065](#) [57102-F02-18ULF](#) [58102-G61-06LF](#) [582553-1](#) [01.001.5753.1](#) [0050291907](#) [02.125.8002.8](#) [609-3404](#) [61062-3](#)
[CSU011177004](#) [622-0430](#) [622-3653LF](#) [63453-116](#) [636-1030](#) [636-1427](#) [636-3427](#) [636-4007](#) [641938-9](#) [65495-038](#) [65692-001LF](#) [65781-018](#)
[65781-047](#) [65817-010LF](#) [65817-015LF](#) [67095-007LF](#) [67601157](#) [68631-112](#) [68645-018](#) [699319-000](#) [70.362.1628.0](#) [70-4210](#) [70-4226B](#) [70-](#)
[4853B](#) [71.350.2428.0](#) [733-134](#) [733-162](#) [MHR-64-VUAL](#) [80.063.4001.1](#) [800-90-001-10-001000](#) [801-43-002-10-013000](#) [801-43-006-10-](#)
[002000](#) [803-43-024-10-001000](#) [803-93-012-10-001000](#) [8-1437020-4](#) [819-22-004-30-001101](#) [820-22-006-30-001101](#) [820-22-008-30-001101](#)
[821-22-002-10-001101](#) [821-22-003-10-002101](#)