

技术特性/Specifications:

额定电压 Rated voltage: 250V AC, DC
额定电流 Rated current: 3A AC, DC
接触电阻 Contact resistance: 20m Ω max
绝缘电阻 Insulation resistance: 1000M Ω min
耐压 Withstand voltage: 1000V AC/minute
环境温度 Ambient temperature: -40 $^{\circ}$ C~+105 $^{\circ}$ C
适用线规 Wire range: AWG#28~#20

| REV. | REVISION DESCRIPTION | DATE | APPD |
|------|----------------------|------|------|
| | | | |

NOTES

- Available in 02Circuits.
- Mates with DL25023-Y Series Housing.
- Material : Nylon UL94V-0(2) .
- 0.64mm Square Pin.
- Pin Material : Brass / Tin-Plated.

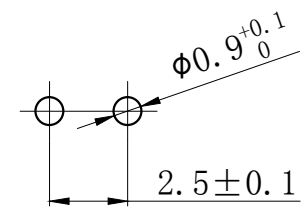
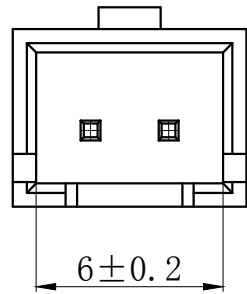
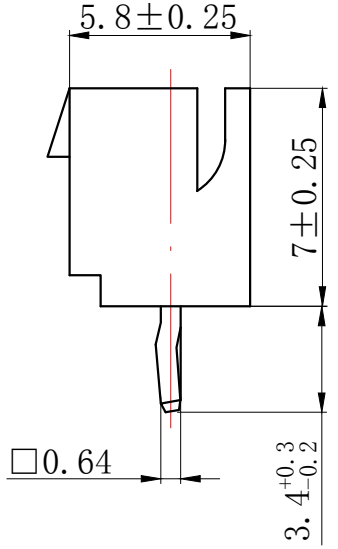
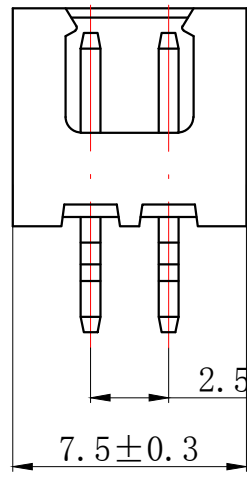
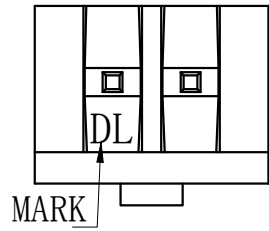

PCB LAYOUT

| GENERAL TOLERANCES (UNLESS SPECIFIED) | | ZHE JIANG DELI CONNECTORS CO., LTD | |
|---------------------------------------|---------------|------------------------------------|--|
| .X: ± 0.25 | X° : ± 3.0° | PRODUCT NAME: | TITLE: 2.50 mm Pitch Wire To Board Wafer |
| .XX: ± 0.15 | .X° : ± 2.0° | DL25023 (TJC3D)-2A | |
| .XXX: ± 0.01 | .XX° : ± 1.0° | DR: Chen Quan Long | DATE: 19/08/01 |
| FINISH: | | CHKD: Wu Hui | DATE: 19/08/01 |
| DRAWING NO: | | APPD: Ren An De | DATE: 19/08/01 |
| | | SCALE: N/A | PAGE: 1/1 |
| | | UNITS: mm | REV.: A |

| REV. | REVISION DESCRIPTION | DATE | APPD |
|------|----------------------|------|------|
| | | | |

NOTES

Available in 03 through 15 Circuits.
 Mates with DL25023-Y Series Housing.
 Material : Nylon UL94V-0(2) .
 0.64mm Square Pin.
 Pin Material : Brass / Tin-Plated.

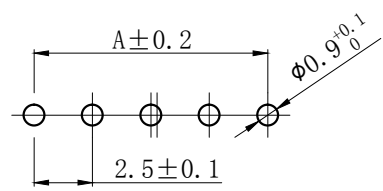
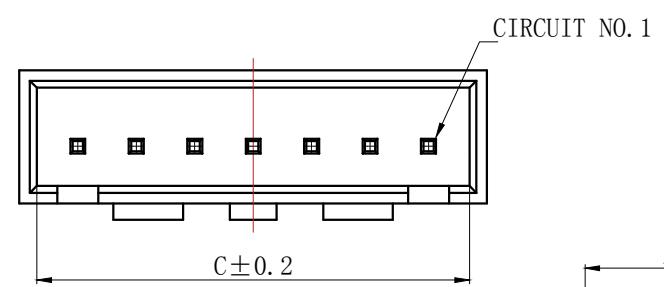
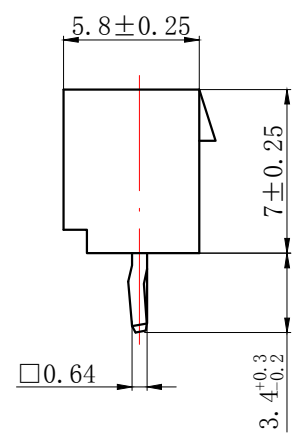
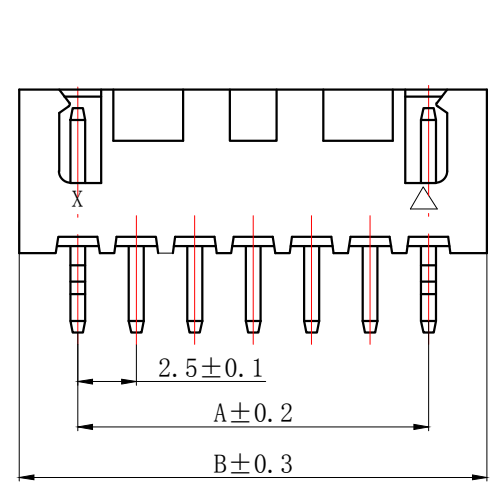
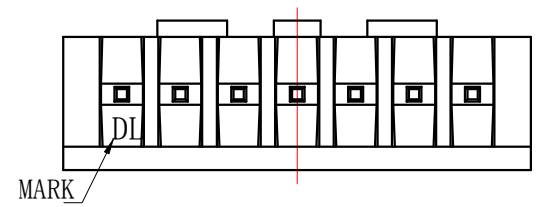

PCB LAYOUT

| Circuits | Product name | Dimension mm | | | Circuits | Product name | Dimension mm | | |
|----------|--------------|--------------|-------|-------|----------|--------------|--------------|-------|-------|
| | | A | B | C | | | A | B | C |
| 3 | TJC3D-3A | 5.00 | 10.00 | 8.50 | 10 | TJC3D-10A | 22.50 | 27.50 | 26.00 |
| 4 | TJC3D-4A | 7.50 | 12.50 | 11.00 | 11 | TJC3D-11A | 25.00 | 30.00 | 28.50 |
| 5 | TJC3D-5A | 10.00 | 15.00 | 13.50 | 12 | TJC3D-12A | 27.50 | 32.50 | 31.00 |
| 6 | TJC3D-6A | 12.50 | 17.50 | 16.00 | 13 | TJC3D-13A | 30.00 | 35.00 | 33.50 |
| 7 | TJC3D-7A | 15.00 | 20.00 | 18.50 | 14 | TJC3D-14A | 32.50 | 37.50 | 36.00 |
| 8 | TJC3D-8A | 17.50 | 22.50 | 21.00 | 15 | TJC3D-15A | 35.00 | 40.00 | 38.50 |
| 9 | TJC3D-9A | 20.00 | 25.00 | 23.50 | | | | | |

| | | | |
|--|---------------|------------------------------------|--|
| GENERAL TOLERANCES (UNLESS SPECIFIED) | | ZHE JIANG DELI CONNECTORS CO., LTD | |
| .X: ± 0.25 | X° : ± 3.0° | PRODUCT NAME: DL25023 (TJC3D)-A | TITLE: 2.50 mm Pitch Wire To Board Wafer |
| .XX: ± 0.15 | .X° : ± 2.0° | DR: Chen Quan Long | DATE: 19/08/01 |
| .XXX: ± 0.01 | .XX° : ± 1.0° | CHKD: Wu Hui | DATE: 19/08/01 |
| FINISH: | | APPD: Ren An De | DATE: 19/08/01 |
| DRAWING NO: | | SCALE: N/A | PAGE: 1/1 |
| | | UNITS: mm | REV.: A |

| REV. | REVISION DESCRIPTION | DATE | APPD |
|------|----------------------|------|------|
| | | | |

NOTES

Available in 02 Circuits.
 Mates with DL25023-Y Series Housing.
 Material : Nylon UL94V-0(2).
 0.64mm Square Pin.
 Pin Material : Brass / Tin-Plated.

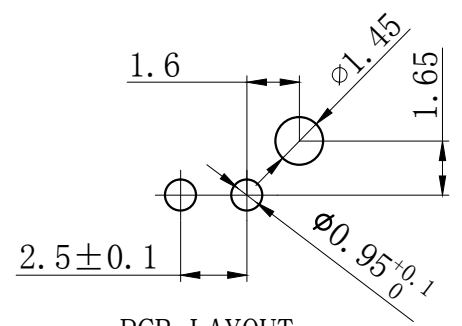
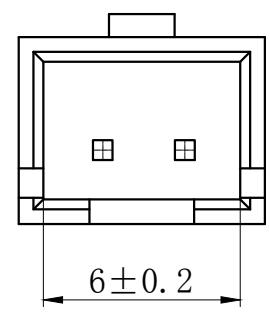

PCB LAYOUT

| GENERAL TOLERANCES (UNLESS SPECIFIED) | | ZHE JIANG DELI CONNECTORS CO., LTD | |
|---------------------------------------|---------------|------------------------------------|--------------------------------------|
| .X: ± 0.25 | X° : ± 3.0° | PRODUCT NAME: | TITLE: |
| .XX: ± 0.15 | .X° : ± 2.0° | DL25023(TJC3D)-2AS | 2.50 mm Pitch Wire To Board Wafer |
| .XXX: ± 0.01 | .XX° : ± 1.0° | DR: Chen Quan Long | DATE:19/08/01 |
| FINISH: | | CHKD: Wu Hui | DATE:19/08/01 |
| DRAWING NO: | | APPD:Ren An De | DATE:19/08/01 |
| | | SCALE: N/A | PAGE: 1/1 |
| | | UNITS: mm | REV.: A |

| REV. | REVISION DESCRIPTION | DATE | APPD |
|------|----------------------|------|------|
| | | | |

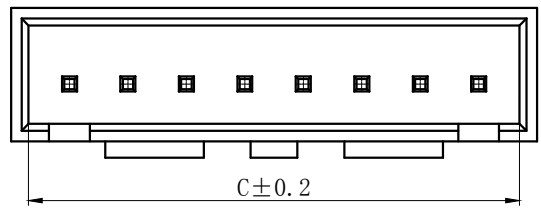
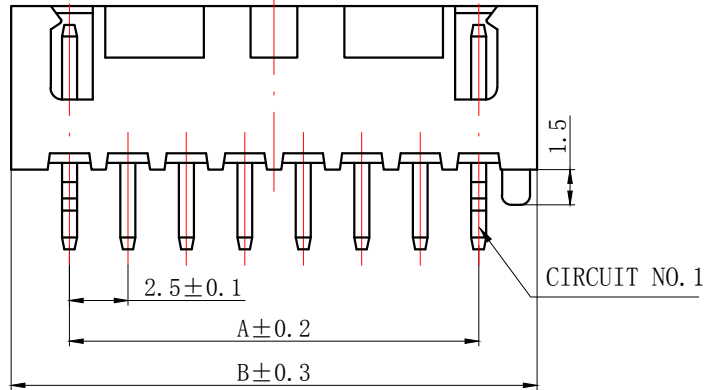
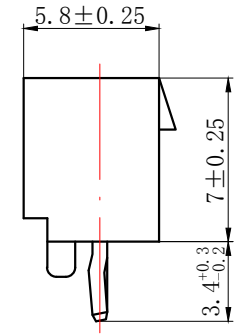

NOTES

Available in 03 through 15 Circuits.
 Mates with DL25023-Y Series Housing.
 Material : Nylon UL94V-0(2).
 0.64mm Square Pin.
 Pin Material : Brass / Tin-Plated.

| Circuits | Product name | Dimension mm | | | Circuits | Product name | Dimension mm | | |
|----------|--------------|--------------|-------|-------|----------|--------------|--------------|-------|-------|
| | | A | B | C | | | A | B | C |
| 3 | TJC3D-3AS | 5.00 | 10.00 | 8.50 | 10 | TJC3D-10AS | 22.50 | 27.50 | 26.00 |
| 4 | TJC3D-4AS | 7.50 | 12.50 | 11.00 | 11 | TJC3D-11AS | 25.00 | 30.00 | 28.50 |
| 5 | TJC3D-5AS | 10.00 | 15.00 | 13.50 | 12 | TJC3D-12AS | 27.50 | 32.50 | 31.00 |
| 6 | TJC3D-6AS | 12.50 | 17.50 | 16.00 | 13 | TJC3D-13AS | 30.00 | 35.00 | 33.50 |
| 7 | TJC3D-7AS | 15.00 | 20.00 | 18.50 | 14 | TJC3D-14AS | 32.50 | 37.50 | 36.00 |
| 8 | TJC3D-8AS | 17.50 | 22.50 | 21.00 | 15 | TJC3D-15AS | 35.00 | 40.00 | 38.50 |
| 9 | TJC3D-9AS | 20.00 | 25.00 | 23.50 | - | - | - | - | - |

| | | | |
|---------------------------------------|-------------|------------------------------------|--|
| GENERAL TOLERANCES (UNLESS SPECIFIED) | | ZHE JIANG DELI CONNECTORS CO., LTD | |
| .X: ±0.25 | X°: ±3.0° | PRODUCT NAME: | TITLE: 2.50 mm Pitch Wire To Board Wafer |
| .XX: ±0.15 | .X°: ±2.0° | DL25023 (TJC3D)-AS | |
| .XXX: ±0.01 | .XX°: ±1.0° | DR: Chen Quan Long | DATE:19/08/01 |
| FINISH: | | CHKD: Wu Hui | DATE:19/08/01 |
| DRAWING NO: | | APPD:Ren An De | DATE:19/08/01 |
| | | SCALE: N/A | PAGE: 1/1 |
| | | UNITS: mm | REV.: A |

| REV. | REVISION DESCRIPTION | DATE | APPD |
|------|----------------------|------|------|
| | | | |

NOTES

Available in 02 Circuits.

Mates with DL25023-Y Series Housing.

Material : Nylon UL94V-0(2).

0.64mm Square Pin.

Pin Material : Brass / Tin-Plated.

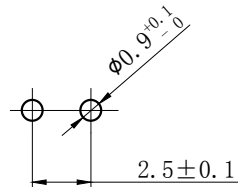
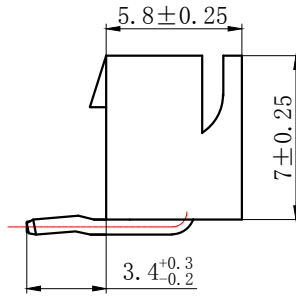

PCB LAYOUT

| GENERAL TOLERANCES (UNLESS SPECIFIED) | | ZHE JIANG DELI CONNECTORS CO., LTD | | | |
|--|-------------|--------------------------------------|----------------|--|-----------|
| .X: ±0.25 | X°: ±3.0° | PRODUCT NAME: DL25023 (TJC3D)-2AW | | TITLE: 2.50 mm Pitch Wire To Board Wafer | |
| .XX: ±0.15 | .X°: ±2.0° | DR: Yuan Jun Rong | DATE: 19/08/01 | PART NO: DL25023-2W-XXX-XX-X-XX | |
| .XXX: ±0.01 | .XX°: ±1.0° | CHKD: Wu Hui | DATE: 19/08/01 | SCALE: N/A | PAGE: 1/1 |
| DRAWING NO: GC-DL25023-2W-XXX-XX-X-XX | | APPD: Ren An De | DATE: 19/08/01 | UNITS: mm | REV.: A |

| | | | |
|------|----------------------|------|------|
| REV. | REVISION DESCRIPTION | DATE | APPD |
| | | | |

A
B
C
D
E
F

A
B
C
D
E
F

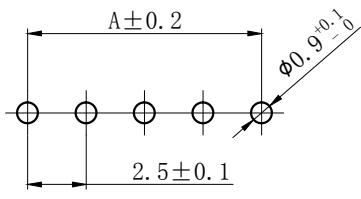
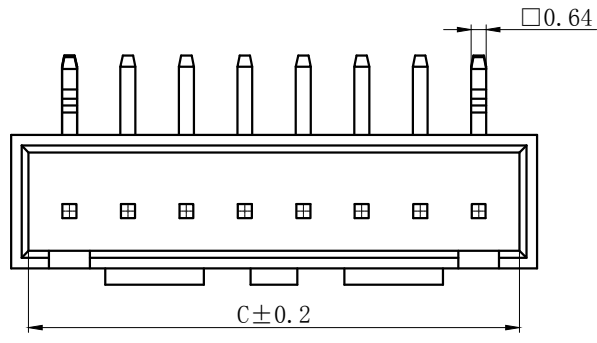
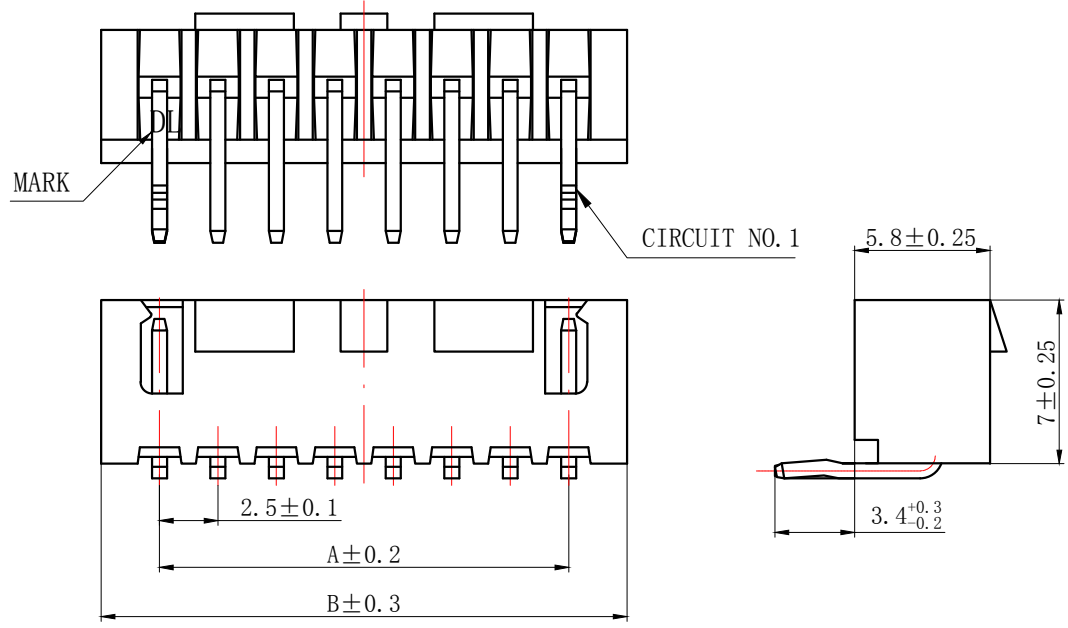

NOTES

Available in 03 through 15 Circuits.
 Mates with DL25023-Y Series Housing.
 Material : Nylon UL94V-0(2).
 0.64mm Square Pin.
 Pin Material : Brass / Tin-Plated.

| Circuits | Product name | Dimension mm | | | Circuits | Product name | Dimension mm | | |
|----------|--------------|--------------|-------|-------|----------|--------------|--------------|-------|-------|
| | | A | B | C | | | A | B | C |
| 3 | TJC3D-3AW-K | 5.00 | 10.00 | 8.50 | 10 | TJC3D-10AW-K | 22.50 | 27.50 | 26.00 |
| 4 | TJC3D-4AW-K | 7.50 | 12.50 | 11.00 | 11 | TJC3D-11AW-K | 25.00 | 30.00 | 28.50 |
| 5 | TJC3D-5AW-K | 10.00 | 15.00 | 13.50 | 12 | TJC3D-12AW-K | 27.50 | 32.50 | 31.00 |
| 6 | TJC3D-6AW-K | 12.50 | 17.50 | 16.00 | 13 | TJC3D-13AW-K | 30.00 | 35.00 | 33.50 |
| 7 | TJC3D-7AW-K | 15.00 | 20.00 | 18.50 | 14 | TJC3D-14AW-K | 32.50 | 37.50 | 36.00 |
| 8 | TJC3D-8AW-K | 17.50 | 22.50 | 21.00 | 15 | TJC3D-15AW-K | 35.00 | 40.00 | 38.50 |
| 9 | TJC3D-9AW-K | 20.00 | 25.00 | 23.50 | | | | | |

| | | | |
|---------------------------------------|-------------|------------------------------------|--|
| GENERAL TOLERANCES (UNLESS SPECIFIED) | | ZHE JIANG DELI CONNECTORS CO., LTD | |
| .X: ±0.25 | X°: ±3.0° | PRODUCT NAME: | TITLE: 2.50 mm Pitch Wire To Board Wafer |
| .XX: ±0.15 | .X°: ±2.0° | DL25023 (TJC3D)-AW-K | |
| .XXX: ±0.01 | .XX°: ±1.0° | DR: Yuan Jun Rong | DATE:19/08/01 |
| FINISH: | | CHKD: Wu Hui | DATE:19/08/01 |
| DRAWING NO: | | APPD:Ren An De | DATE:19/08/01 |
| | | SCALE: N/A | PAGE: 1/1 |
| | | UNITS: mm | REV.: A |

F

| REV. | REVISION DESCRIPTION | DATE | APPD |
|------|----------------------|------|------|
| | | | |

NOTES

Available in 022 Circuits.

Mates with DL25023-Y Series Housing.

Material : Nylon UL94V-0(2).

0.64mm Square Pin.

Pin Material : Brass / Tin-Plated.

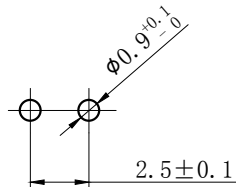
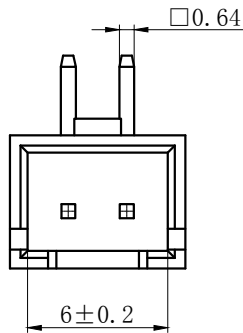
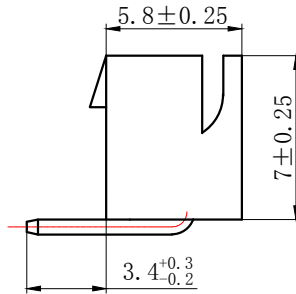

PCB LAYOUT

| GENERAL TOLERANCES (UNLESS SPECIFIED) | | ZHE JIANG DELI CONNECTORS CO., LTD | |
|--|-------------|------------------------------------|--|
| .X: ±0.25 | X°: ±3.0° | PRODUCT NAME: | TITLE: 2.50 mm Pitch Wire To Board Wafer |
| .XX: ±0.15 | .X°: ±2.0° | DL25023(TJC3D)-2AW-Z | |
| .XXX: ±0.01 | .XX°: ±1.0° | DR: Chen Quan Long | DATE:19/08/01 |
| FINISH: | | CHKD: Wu Hui | DATE:19/08/01 |
| DRAWING NO: | | APPD:Ren An De | DATE:19/08/01 |
| | | SCALE: N/A | PAGE: 1/1 |
| | | UNITS: mm | REV.: A |

| REV. | REVISION DESCRIPTION | DATE | APPD |
|------|----------------------|------|------|
| | | | |

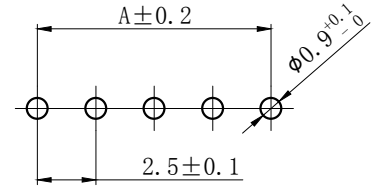
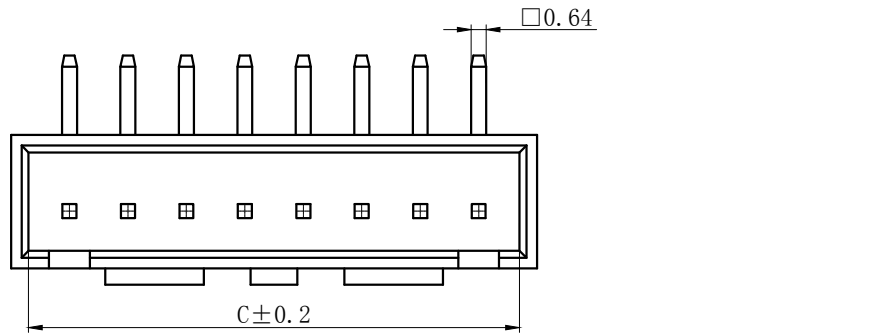
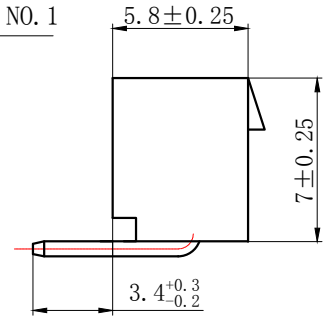

PCB LAYOUT

NOTES

Available in 03 through 15 Circuits.
 Mates with DL25023-Y Series Housing.
 Material : Nylon UL94V-0(2).
 0.64mm Square Pin.
 Pin Material : Brass / Tin-Plated.

| Circuits | Product name | Dimension mm | | | Circuits | Product name | Dimension mm | | |
|----------|--------------|--------------|-------|-------|----------|--------------|--------------|-------|-------|
| | | A | B | C | | | A | B | C |
| 3 | TJC3D-3AW-Z | 5.00 | 10.00 | 8.50 | 10 | TJC3D-10AW-Z | 22.50 | 27.50 | 26.00 |
| 4 | TJC3D-4AW-Z | 7.50 | 12.50 | 11.00 | 11 | TJC3D-11AW-Z | 25.00 | 30.00 | 28.50 |
| 5 | TJC3D-5AW-Z | 10.00 | 15.00 | 13.50 | 12 | TJC3D-12AW-Z | 27.50 | 32.50 | 31.00 |
| 6 | TJC3D-6AW-Z | 12.50 | 17.50 | 16.00 | 13 | TJC3D-13AW-Z | 30.00 | 35.00 | 33.50 |
| 7 | TJC3D-7AW-Z | 15.00 | 20.00 | 18.50 | 14 | TJC3D-14AW-Z | 32.50 | 37.50 | 36.00 |
| 8 | TJC3D-8AW-Z | 17.50 | 22.50 | 21.00 | 15 | TJC3D-15AW-Z | 35.00 | 40.00 | 38.50 |
| 9 | TJC3D-9AW-Z | 20.00 | 25.00 | 23.50 | | | | | |

| GENERAL TOLERANCES (UNLESS SPECIFIED) | | ZHE JIANG DELI CONNECTORS CO., LTD | |
|---------------------------------------|---------------|------------------------------------|--|
| .X: ±0.25 | X° : ± 3.0° | PRODUCT NAME: | TITLE: 2.50 mm Pitch Wire To Board Wafer |
| .XX: ± 0.15 | .X° : ± 2.0° | DL25023 (TJC3D)-AW-Z | |
| .XXX: ± 0.01 | .XX° : ± 1.0° | DR: Chen Quan Long | DATE:19/08/01 |
| FINISH: | | CHKD: Wu Hui | DATE:19/08/01 |
| DRAWING NO: | | APPD:Ren An De | DATE:19/08/01 |
| | | SCALE: N/A | PAGE: 1/1 |
| | | UNITS: mm | REV.: A |

| REV. | REVISION DESCRIPTION | DATE | APPD |
|------|----------------------|------|------|
| | | | |

NOTES

Available in 02 Circuits.

Mates with DL25023-Y Series Housing.

Material : Nylon UL94V-0(2).

0.64mm Square Pin.

Pin Material : Brass / Tin-Plated.

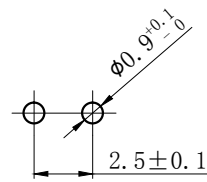
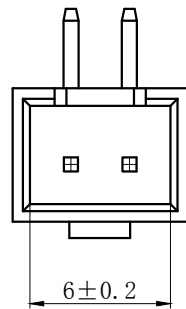
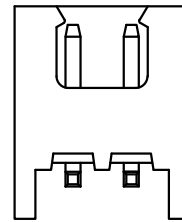
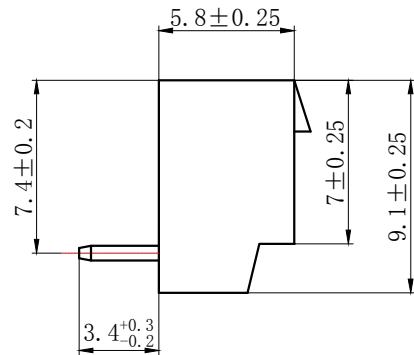
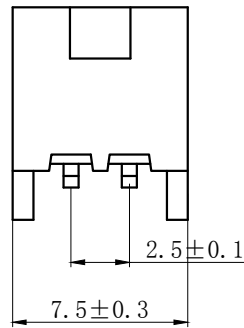
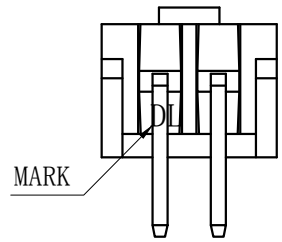

PCB LAYOUT

| GENERAL TOLERANCES (UNLESS SPECIFIED) | | ZHE JIANG DELI CONNECTORS CO., LTD | |
|--|---|------------------------------------|---|
| .X: ±0.25 | X°: ±3.0° | PRODUCT NAME: | TITLE: 2.50 mm Pitch Wire To Board Wafer |
| .XX: ±0.15 | .X°: ±2.0° | DL25023 (TJC3D)-2AWD-Z | |
| .XXX: ±0.01 | .XX°: ±1.0° | DR: Chen Quan Long | DATE:19/08/01 |
| FINISH: |  | CHKD: Wu Hui | DATE:19/08/01 |
| DRAWING NO: | | APPD:Ren An De | DATE:19/08/01 |
| | | | SCALE: N/A |
| | | | PAGE: 1/1 |
| | | | UNITS: mm |
| | | | REV.: A |

| REV. | REVISION DESCRIPTION | DATE | APPD |
|------|----------------------|------|------|
| | | | |

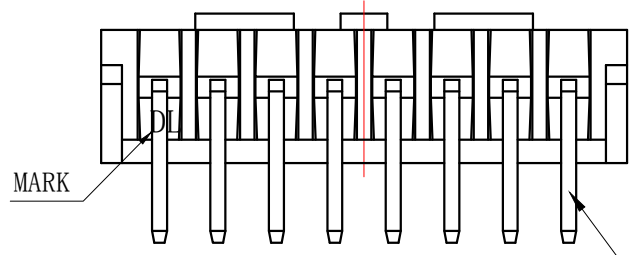

CIRCUIT NO. 1

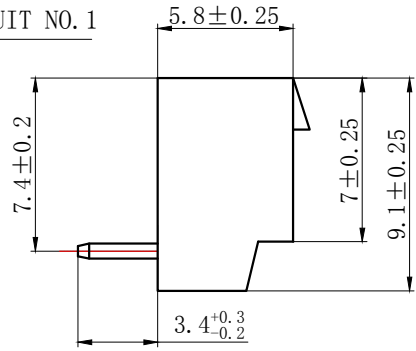
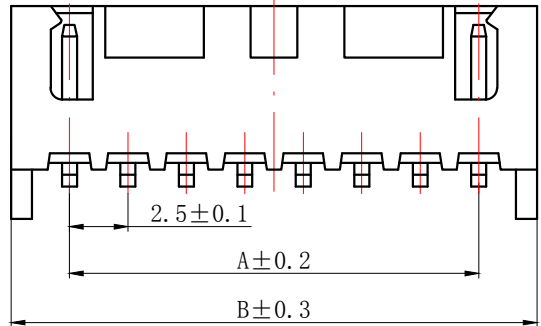

NOTES

Available in 03 through 15 Circuits.
Mates with DL25023-Y Series Housing.
Material : Nylon UL94V-0(2).
0.64mm Square Pin.
Pin Material : Brass / Tin-Plated.



| Circuits | Product name | Dimension mm | | | Circuits | Product name | Dimension mm | | |
|----------|--------------|--------------|-------|-------|----------|---------------|--------------|-------|-------|
| | | A | B | C | | | A | B | C |
| 3 | TJC3D-3AWD-Z | 5.00 | 10.00 | 8.50 | 10 | TJC3D-10AWD-Z | 22.50 | 27.50 | 26.00 |
| 4 | TJC3D-4AWD-Z | 7.50 | 12.50 | 11.00 | 11 | TJC3D-11AWD-Z | 25.00 | 30.00 | 28.50 |
| 5 | TJC3D-5AWD-Z | 10.00 | 15.00 | 13.50 | 12 | TJC3D-12AWD-Z | 27.50 | 32.50 | 31.00 |
| 6 | TJC3D-6AWD-Z | 12.50 | 17.50 | 16.00 | 13 | TJC3D-13AWD-Z | 30.00 | 35.00 | 33.50 |
| 7 | TJC3D-7AWD-Z | 15.00 | 20.00 | 18.50 | 14 | TJC3D-14AWD-Z | 32.50 | 37.50 | 36.00 |
| 8 | TJC3D-8AWD-Z | 17.50 | 22.50 | 21.00 | 15 | TJC3D-15AWD-Z | 35.00 | 40.00 | 38.50 |
| 9 | TJC3D-9AWD-Z | 20.00 | 25.00 | 23.50 | | | | | |

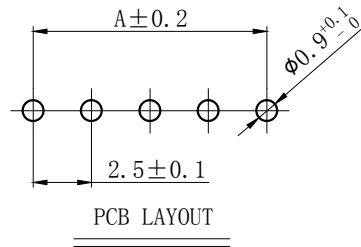

| | | | |
|---------------------------------------|-------------|------------------------------------|--|
| GENERAL TOLERANCES (UNLESS SPECIFIED) | | ZHE JIANG DELI CONNECTORS CO., LTD | |
| .X: ±0.25 | X°: ±3.0° | PRODUCT NAME: | TITLE: 2.50 mm Pitch Wire To Board Wafer |
| .XX: ±0.15 | .X°: ±2.0° | DL25023 (TJC3D)-AWD-Z | |
| .XXX: ±0.01 | .XX°: ±1.0° | DR: Chen Quan Long | DATE:19/08/01 |
| FINISH: | | CHKD: Wu Hui | DATE:19/08/01 |
| DRAWING NO: | | APPD:Ren An De | DATE:19/08/01 |
| | | PART NO: | SCALE: N/A |
| | | | PAGE: 1/1 |
| | | UNITS: mm | REV.: A |

| REV. | REVISION DESCRIPTION | DATE | APPD |
|------|----------------------|------|------|
| | | | |

NOTES

Available in 02 Circuits.
Mates with DL25023-Y Series Housing.
Material : Nylon UL94V-0(2).
0.64mm Square Pin.
Pin Material : Brass / Tin-Plated.



| GENERAL TOLERANCES (UNLESS SPECIFIED) | | ZHE JIANG DELI CONNECTORS CO., LTD | |
|--|-------------|---|--|
| .X: ±0.25 | X°: ±3.0° | PRODUCT NAME: DL25023 (TJC3D)-2AWD-K | TITLE: 2.50 mm Pitch Wire To Board Wafer |
| .XX: ±0.15 | .X°: ±2.0° | DR: Chen Quan Long | DATE:19/08/01 |
| .XXX: ±0.01 | .XX°: ±1.0° | CHKD: Wu Hui | DATE:19/08/01 |
| FINISH: _____ | | APPD: Ren An De | DATE:19/08/01 |
| DRAWING NO: | | SCALE: N/A | PAGE: 1/1 |
| | | UNITS: mm | REV.: A |

| REV. | REVISION DESCRIPTION | DATE | APPD |
|------|----------------------|------|------|
| | | | |



CIRCUIT NO. 1



NOTES

Available in 03 through 15 Circuits.
 Mates with DL25023-Y Series Housing.
 Material : Nylon UL94V-0(2).
 0.64mm Square Pin.
 Pin Material : Brass / Tin-Plated.

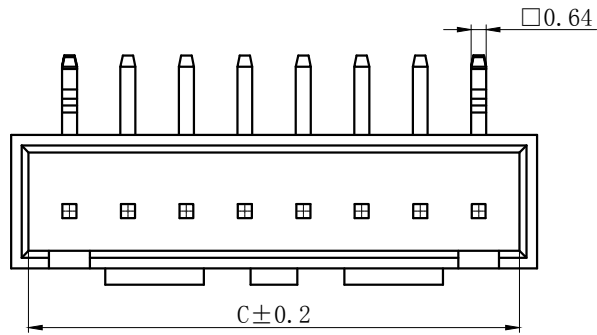

| Circuits | Product name | Dimension mm | | | Circuits | Product name | Dimension mm | | |
|----------|--------------|--------------|-------|-------|----------|---------------|--------------|-------|-------|
| | | A | B | C | | | A | B | C |
| 3 | TJC3D-3AWD-K | 5.00 | 10.00 | 8.50 | 10 | TJC3D-10AWD-K | 22.50 | 27.50 | 26.00 |
| 4 | TJC3D-4AWD-K | 7.50 | 12.50 | 11.00 | 11 | TJC3D-11AWD-K | 25.00 | 30.00 | 28.50 |
| 5 | TJC3D-5AWD-K | 10.00 | 15.00 | 13.50 | 12 | TJC3D-12AWD-K | 27.50 | 32.50 | 31.00 |
| 6 | TJC3D-6AWD-K | 12.50 | 17.50 | 16.00 | 13 | TJC3D-13AWD-K | 30.00 | 35.00 | 33.50 |
| 7 | TJC3D-7AWD-K | 15.00 | 20.00 | 18.50 | 14 | TJC3D-14AWD-K | 32.50 | 37.50 | 36.00 |
| 8 | TJC3D-8AWD-K | 17.50 | 22.50 | 21.00 | 15 | TJC3D-15AWD-K | 35.00 | 40.00 | 38.50 |
| 9 | TJC3D-9AWD-K | 20.00 | 25.00 | 23.50 | | | | | |

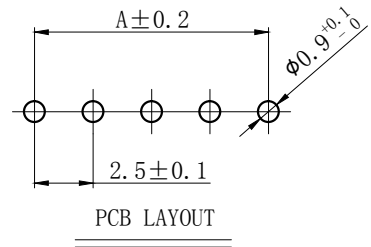

PCB LAYOUT

| GENERAL TOLERANCES (UNLESS SPECIFIED) | | ZHE JIANG DELI CONNECTORS CO., LTD | |
|---------------------------------------|-------------|------------------------------------|--|
| .X: ±0.25 | .X°: ±3.0° | PRODUCT NAME: | TITLE: 2.50 mm Pitch Wire To Board Wafer |
| .XX: ±0.15 | .X°: ±2.0° | DL25023 (TJC3D)-AWD-K | |
| .XXX: ±0.01 | .XX°: ±1.0° | DR: Chen Quan Long | DATE:19/08/01 |
| FINISH: | | CHKD: Wu Hui | DATE:19/08/01 |
| DRAWING NO: | | APPD:Ren An De | DATE:19/08/01 |
| | | | PART NO: |
| | | | SCALE: N/A |
| | | | PAGE: 1/1 |
| | | | UNITS: mm |
| | | | REV.: A |

| REV. | REVISION DESCRIPTION | DATE | APPD |
|------|----------------------|------|------|
| | | | |



NOTES

Available in 02 through 15 Circuits.
 Mates with DL25023-Y Series Housing.
 Material : Nylon UL94V-0(2).
 0.64mm Square Pin.
 Pin Material : Brass / Tin-Plated.

| Circuits | Product name | Dimension mm | | | Circuits | Product name | Dimension mm | | |
|----------|--------------|--------------|-------|-------|----------|--------------|--------------|-------|-------|
| | | A | B | C | | | A | B | C |
| 2 | TJC3D-2AWF | 2.50 | 7.50 | 6.50 | 9 | TJC3D-9AWF | 20.00 | 25.00 | 23.50 |
| 3 | TJC3D-3AWF | 5.00 | 10.00 | 8.50 | 10 | TJC3D-10AWF | 22.50 | 27.50 | 26.00 |
| 4 | TJC3D-4AWF | 7.50 | 12.50 | 11.00 | 11 | TJC3D-11AWF | 25.00 | 30.00 | 28.50 |
| 5 | TJC3D-5AWF | 10.00 | 15.00 | 13.50 | 12 | TJC3D-12AWF | 27.50 | 32.50 | 31.00 |
| 6 | TJC3D-6AWF | 12.50 | 17.50 | 16.00 | 13 | TJC3D-13AWF | 30.00 | 35.00 | 33.50 |
| 7 | TJC3D-7AWF | 15.00 | 20.00 | 18.50 | 14 | TJC3D-14AWF | 32.50 | 37.50 | 36.00 |
| 8 | TJC3D-8AWF | 17.50 | 22.50 | 21.00 | 15 | TJC3D-15AWF | 35.00 | 40.00 | 38.50 |

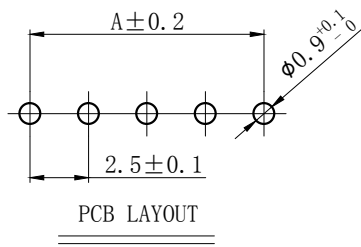

| | | | |
|---------------------------------------|--------------|--------------------------------------|--|
| GENERAL TOLERANCES (UNLESS SPECIFIED) | | ZHE JIANG DELI CONNECTORS CO., LTD | |
| .X: ± 0.25 | .X°: ± 3.0° | PRODUCT NAME: DL25023 (TJC3D)-AWF | TITLE: 2.50 mm Pitch Wire To Board Wafer |
| .XX: ± 0.15 | .X°: ± 2.0° | DR: Chen Quan Long | DATE:19/08/01 |
| .XXX: ± 0.01 | .XX°: ± 1.0° | CHKD: Wu Hui | DATE:19/08/01 |
| FINISH: | | APPD: Ren An De | DATE:19/08/01 |
| DRAWING NO: | | | |
| | | SCALE: N/A | PAGE: 1/1 |
| | | UNITS: mm | REV.: A |

| REV. | REVISION DESCRIPTION | DATE | APPD |
|------|----------------------|------|------|
| | | | |



NOTES

Available in 02 through 15 Circuits.
 Match with DL25023 series housing
 Material : Nylon UL94V-0(2).
 Accepts DL25023-T Crimp Terminal.

| Circuits | Product name | Dimension mm | | | | Circuits | Product name | Dimension mm | | | |
|----------|--------------|--------------|-------|-------|-------|----------|--------------|--------------|-------|-------|------|
| | | A | B | C | D | | | A | B | C | D |
| 2 | TJC3D-2Y | 2.50 | 7.00 | 5.70 | 5.30 | 10 | TJC3D-10Y | 22.50 | 27.00 | 25.70 | 15.1 |
| 3 | TJC3D-3Y | 5.00 | 9.50 | 8.20 | 5.10 | 11 | TJC3D-11Y | 25.00 | 29.50 | 28.20 | 15.1 |
| 4 | TJC3D-4Y | 7.50 | 12.00 | 10.70 | 5.10 | 12 | TJC3D-12Y | 27.50 | 32.00 | 30.70 | 15.1 |
| 5 | TJC3D-5Y | 10.00 | 14.50 | 13.20 | 7.60 | 13 | TJC3D-13Y | 30.00 | 34.50 | 33.20 | 15.1 |
| 6 | TJC3D-6Y | 12.50 | 17.00 | 15.70 | 10.10 | 14 | TJC3D-14Y | 32.50 | 37.00 | 35.70 | 15.1 |
| 7 | TJC3D-7Y | 15.00 | 19.50 | 18.20 | 12.60 | 15 | TJC3D-15Y | 35.00 | 39.50 | 38.20 | 15.1 |
| 8 | TJC3D-8Y | 17.50 | 22.00 | 20.70 | 15.10 | - | - | - | - | - | - |
| 9 | TJC3D-9Y | 20.00 | 24.50 | 23.20 | 17.60 | - | - | - | - | - | - |

| | | | |
|--|--------------|------------------------------------|---------------------------------|
| GENERAL TOLERANCES (UNLESS SPECIFIED) | | ZHE JIANG DELI CONNECTORS CO., LTD | |
| .X: ± 0.25 | .X°: ± 3.0° | PRODUCT NAME: DL25023 (TJC3D)-Y | TITLE: 2.50 mm Pitch Housing |
| .XX: ± 0.15 | .X°: ± 2.0° | DR: Chen Quan Long | DATE: 19/08/01 |
| .XXX: ± 0.01 | .XX°: ± 1.0° | CHKD: Wu Hui | DATE: 19/08/01 |
| FINISH: _____ | | APPD: Ren An De | DATE: 19/08/01 |
| DRAWING NO: | | SCALE: N/A | PAGE: 1/1 |
| | | UNITS: mm | REV.: A |

| REV. | REVISION DESCRIPTION | DATE | APPD |
|------|----------------------|------|------|
| | | | |

NOTES

Available in 02 through 20 Circuits.
 Match with DL25023-Y series housing
 Material : Nylon UL94V-0(2).
 Accepts DL25023-RT Crimp Terminal.

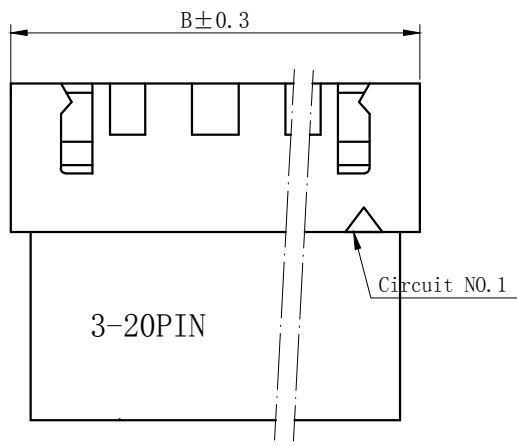
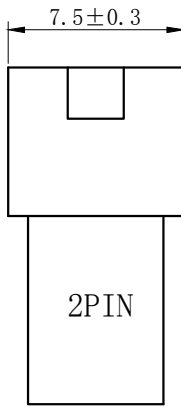

| Circuits | Product name | Dimension mm | | | Circuits | Product name | Dimension mm | | |
|----------|--------------|--------------|-------|-------|----------|--------------|--------------|-------|-------|
| | | A | B | C | | | A | B | C |
| 2 | TJC3D-2R | 2.50 | 7.50 | 6.00 | 10 | TJC3D-10R | 22.50 | 27.50 | 26.00 |
| 3 | TJC3D-3R | 5.00 | 10.00 | 8.50 | 11 | TJC3D-11R | 25.00 | 30.00 | 28.50 |
| 4 | TJC3D-4R | 7.50 | 12.50 | 11.00 | 12 | TJC3D-12R | 27.50 | 32.50 | 31.00 |
| 5 | TJC3D-5R | 10.00 | 15.00 | 13.50 | 13 | TJC3D-13R | 30.00 | 35.00 | 33.50 |
| 6 | TJC3D-6R | 12.50 | 17.50 | 16.00 | 14 | TJC3D-14R | 32.50 | 37.50 | 36.00 |
| 7 | TJC3D-7R | 15.00 | 20.00 | 18.50 | 15 | TJC3D-15R | 35.00 | 40.00 | 38.50 |
| 8 | TJC3D-8R | 17.50 | 22.50 | 21.00 | - | - | - | - | - |
| 9 | TJC3D-9R | 20.00 | 25.00 | 23.50 | 20 | TJC3D-20R | 47.50 | 52.50 | 51.00 |

| | | | |
|--|--------------|------------------------------------|--|
| GENERAL TOLERANCES (UNLESS SPECIFIED) | | ZHE JIANG DELI CONNECTORS CO., LTD | |
| .X: ± 0.25 | X°: ± 3.0° | PRODUCT NAME: | TITLE: 2.50 mm Pitch Wire To Wire Housing |
| .XX: ± 0.15 | .X°: ± 2.0° | DL25023 (TJC3D)-R | PART NO: |
| .XXX: ± 0.01 | .XX°: ± 1.0° | DR:Chen Quan Long | |
| FINISH: | | CHKD: Wu Hui | DATE:20/12/30 |
| DRAWING NO: | | APPD:Ren An De | DATE:20/12/30 |
| | | SCALE: N/A | PAGE: 1/1 |
| | | UNITS: mm | REV.: A |

| | | | |
|------|----------------------|------|------|
| REV. | REVISION DESCRIPTION | DATE | APPD |
| | | | |

NOTES

Available in 02 through 20 Circuits.
 Match with DL25001-Y series housing
 Material : Nylon UL94V-0(2).



| Circuits | Product name | Dimension mm | | Circuits | Product name | Dimension mm | |
|----------|--------------|--------------|------|----------|--------------|--------------|------|
| | | A | B | | | A | B |
| 2 | TJC3-2S | 2.50 | 8.7 | 9 | TJC3-9S | 20.00 | 26.2 |
| 3 | TJC3-3S | 5.00 | 11.2 | 10 | TJC3-10S | 22.50 | 28.7 |
| 4 | TJC3-4S | 7.50 | 13.7 | 11 | TJC3-11S | 25.00 | 31.2 |
| 5 | TJC3-5S | 10.00 | 16.2 | 12 | TJC3-12S | 27.50 | 33.7 |
| 6 | TJC3-6S | 12.50 | 18.7 | 13 | TJC3-13S | 30.00 | 36.2 |
| 7 | TJC3-7S | 15.00 | 21.2 | ~ | ~ | ~ | ~ |
| 8 | TJC3-8S | 17.50 | 23.7 | 20 | TJC3-20S | 47.80 | 53.7 |

| | | | | | |
|--|--------------|------------------------------------|---------------|---------------------------------|-----------|
| GENERAL TOLERANCES (UNLESS SPECIFIED) | | ZHE JIANG DELI CONNECTORS CO., LTD | | | |
| .X: ± 0.25 | X°: ± 3.0° | PRODUCT NAME: DL25001(TJC3)-S | | TITLE: 2.50 mm Pitch Housing | |
| .XX: ± 0.15 | .X°: ± 2.0° | DR: Yuan Jun Rong | DATE:21/03/18 | PART NO: | |
| .XXX: ± 0.01 | .XX°: ± 1.0° | CHKD: Wu Hui | DATE:21/03/18 | SCALE: N/A | PAGE: 1/1 |
| FINISH: | | APPD: Ren An De | DATE:21/03/18 | UNITS: mm | REV.: A |
| DRAWING NO: | | | | | |

| REV. | REVISION DESCRIPTION | DATE | APPD |
|------|----------------------|------|------|
| | | | |



NOTES

Used in DL25001-Y Series Housing.
 Accepts AWG #24~20 Wire Range.
 Material : Phosphor Bronze .
 Finish: Tin plated.
 Thickness: 0.2 mm.



| GENERAL TOLERANCES (UNLESS SPECIFIED) | | | | ZHE JIANG DELI CONNECTORS CO., LTD | | | |
|--|--------------|---|----------------|---|--|-----------|--|
| .X: ± 0.25 | X°: ± 3.0° | PRODUCT NAME: DL25001(TJC3)-T-G | | TITLE: 2.50 mm Pitch Crimp Terminal | | PART NO: | |
| .XX: ± 0.15 | .X°: ± 2.0° | DR: Chen Quan Long | DATE: 19/08/01 | SCALE: N/A | | PAGE: 1/1 | |
| .XXX: ± 0.01 | .XX°: ± 1.0° | CHKD: Wu Hui | DATE: 19/08/01 | UNITS: mm | | REV.: A | |
| DRAWING NO: | | APPD: Ren An De | DATE: 19/08/01 | | | | |

| REV. | REVISION DESCRIPTION | DATE | APPD |
|------|----------------------|------|------|
| | | | |

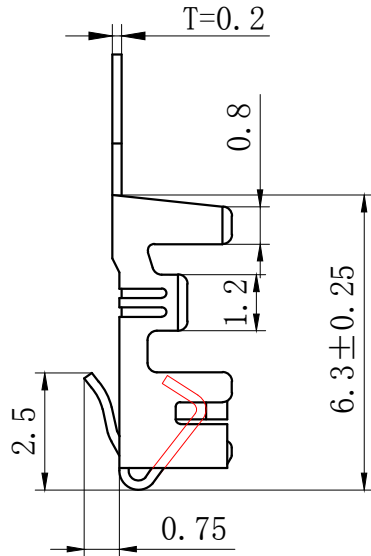
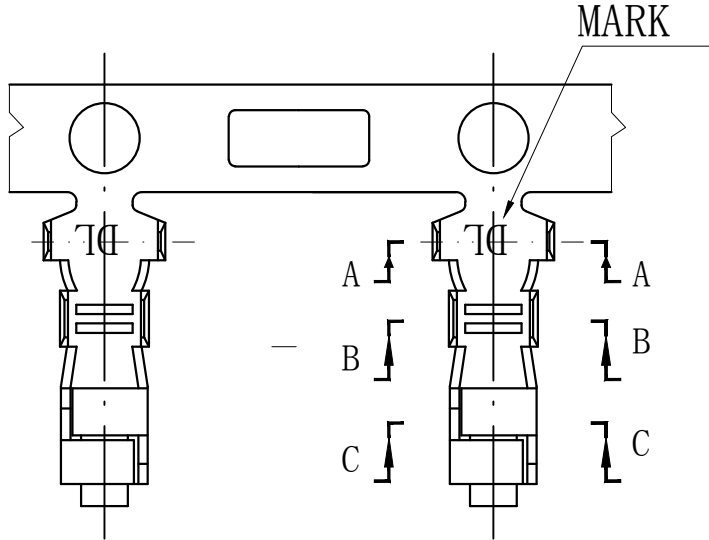

NOTES

Used in DL25001-Y Series Housing.
 Accepts AWG #28~22 Wire Range.
 0.08~ 0.33 mm² .
 Insulation O.D.=1.2~1.9 mm.
 Material : Phosphor Bronze .
 Finish: Tin plated.
 Thickness: 0.2 mm.

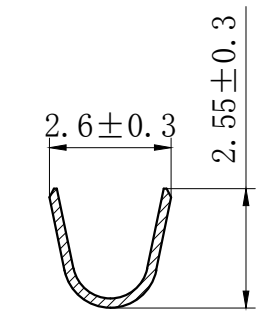

SECTION A-A

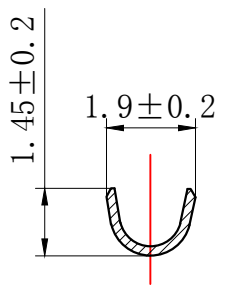

SECTION B-B

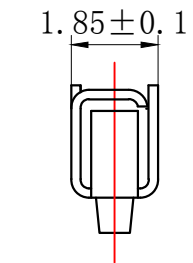

SECTION C-C

| GENERAL TOLERANCES (UNLESS SPECIFIED) | | ZHE JIANG DELI CONNECTORS CO.,LTD | |
|--|---------------|--|---|
| .X: ± 0.25 | X° : ± 3.0° | PRODUCT NAME: DL25001 (TJC3)-T | TITLE: 2.50 mm Pitch Crimp Terminal |
| .XX: ± 0.15 | .X° : ± 2.0° | DR:Chen Quan Long | DATE:19/08/01 |
| .XXX: ± 0.01 | .XX° : ± 1.0° | CHKD: Wu Hui | DATE:19/08/01 |
| FINISH: | | APPD:Ren An De | DATE:19/08/01 |
| DRAWING NO: | | | |
| | | | |

| REV. | REVISION DESCRIPTION | DATE | APPD |
|------|----------------------|------|------|
| | | | |

NOTES

Used in DL25002-R Series Housing.
Accepts AWG #28~22 Wire Range.

0.08~ 0.33 mm² .

Insulation O.D. =1.2~1.9 mm.

Material : Phosphor Bronze .

Finish: Tin plated.

Thickness: 0.2 mm.

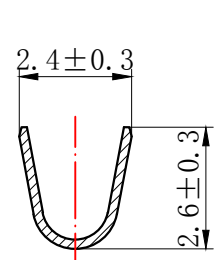
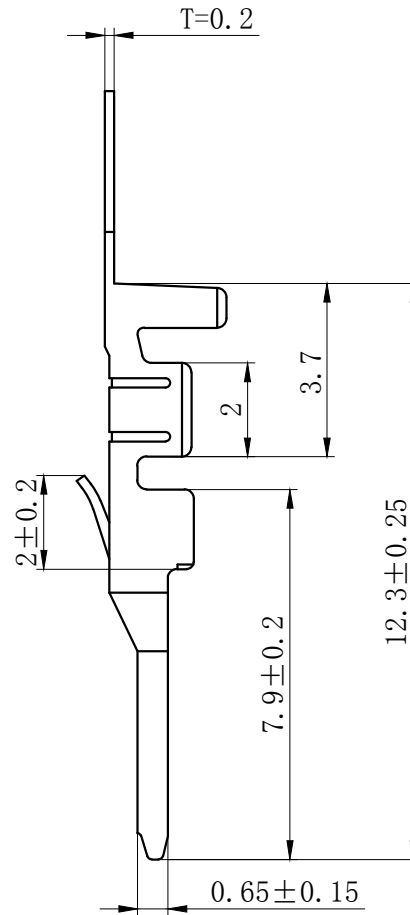
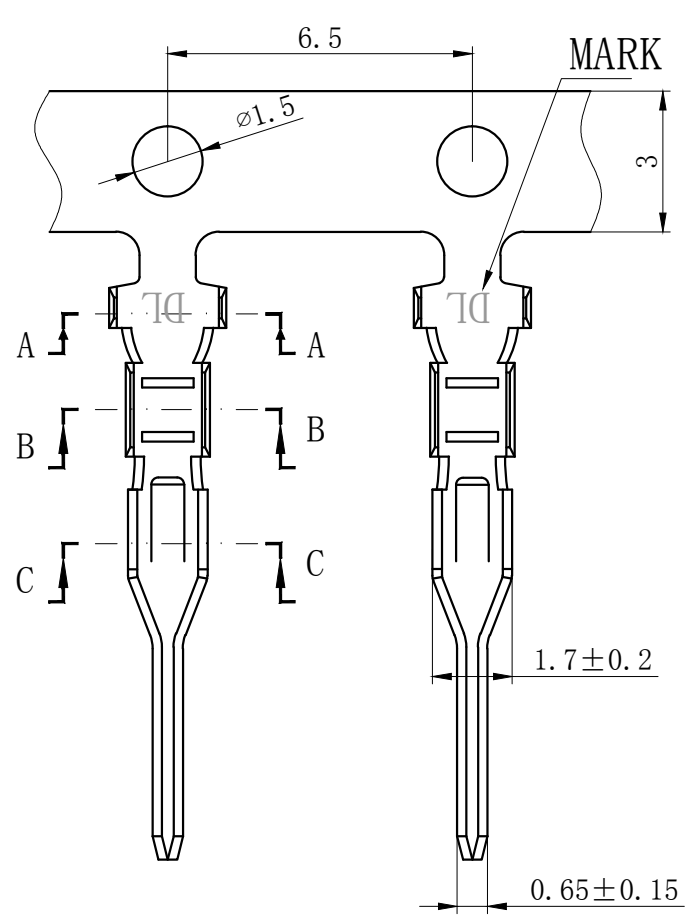

SECTION A-A

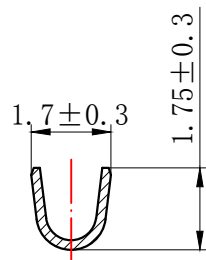

SECTION B-B

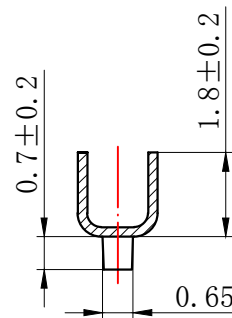

SECTION C-C

| GENERAL TOLERANCES (UNLESS SPECIFIED) | | | | ZHE JIANG DELI CONNECTORS CO., LTD | | | |
|--|--------------|-------------------------------------|----------------|--|-----------|--|--|
| .X: ± 0.25 | X°: ± 3.0° | PRODUCT NAME: DL25002 (TJC3B)-RT | | TITLE: 2.50 mm Pitch Wire To Wire Terminal | | | |
| .XX: ± 0.15 | .X°: ± 2.0° | DR: Chen Quan Long | DATE: 20/12/30 | PART NO: | | | |
| .XXX: ± 0.01 | .XX°: ± 1.0° | CHKD: Wu Hui | DATE: 20/12/30 | SCALE: N/A | PAGE: 1/1 | | |
| DRAWING NO: | | APPD: Ren An De | DATE: 20/12/30 | UNITS: mm | REV.: A | | |

X-ON Electronics

Largest Supplier of Electrical and Electronic Components

Click to view similar products for [Headers & Wire Housings](#) category:

Click to view products by [DLL](#) manufacturer:

Other Similar products are found below :

[0015917161](#) [0022155065](#) [57102-F02-18ULF](#) [58102-G61-06LF](#) [582553-1](#) [01.001.5753.1](#) [0050291907](#) [02.125.8002.8](#) [609-3404](#) [61062-3](#)
[CSU011177004](#) [622-0430](#) [622-3653LF](#) [63453-116](#) [636-1030](#) [636-1427](#) [636-3427](#) [636-4007](#) [641938-9](#) [65495-038](#) [65692-001LF](#) [65781-018](#)
[65781-047](#) [65817-010LF](#) [65817-015LF](#) [67095-007LF](#) [67601157](#) [68631-112](#) [68645-018](#) [699319-000](#) [70.362.1628.0](#) [70-4210](#) [70-4226B](#) [70-](#)
[4853B](#) [71.350.2428.0](#) [733-134](#) [733-162](#) [760-3052](#) [MHR-64-VUAL](#) [80.063.4001.1](#) [800-90-001-10-001000](#) [801-43-002-10-013000](#)
[801-43-006-10-002000](#) [803-43-024-10-001000](#) [803-93-012-10-001000](#) [8-1437020-4](#) [819-22-004-30-001101](#) [820-22-006-30-001101](#)
[820-22-008-30-001101](#) [821-22-002-10-001101](#)