

技术特性/Specifications:

额定电压 Rated voltage: 250V AC, DC
额定电流 Rated current: 3A AC, DC
接触电阻 Contact resistance: 20m Ω max
绝缘电阻 Insulation resistance: 1000M Ω min
耐压 Withstand voltage: 1000V AC/minute
环境温度 Ambient temperature: -40 $^{\circ}$ C~+105 $^{\circ}$ C
适用线规 Wire range: AWG#28~#20

REV.	REVISION DESCRIPTION	DATE	APPD

NOTES

- Available in 02Circuits.
- Mates with DL25023-Y Series Housing.
- Material : Nylon UL94V-0(2).
- 0.64mm Square Pin.
- Pin Material : Brass / Tin-Plated.

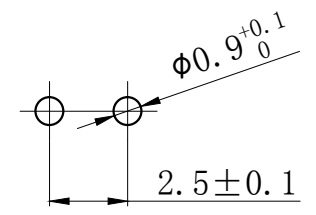
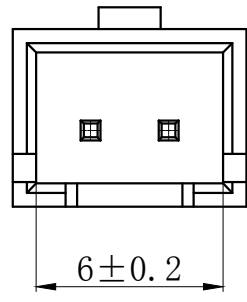
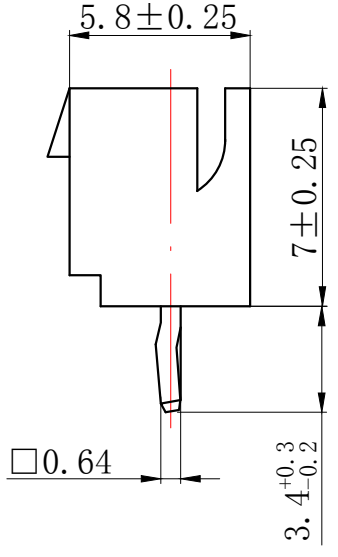
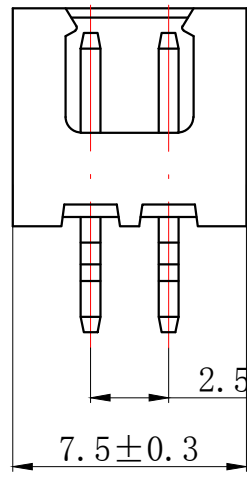
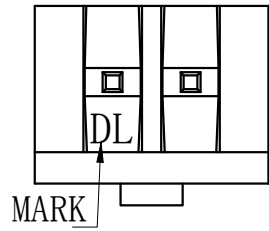

PCB LAYOUT

GENERAL TOLERANCES (UNLESS SPECIFIED)		ZHE JIANG DELI CONNECTORS CO., LTD	
.X: ± 0.25	X° : ± 3.0°	PRODUCT NAME:	TITLE: 2.50 mm Pitch Wire To Board Wafer
.XX: ± 0.15	.X° : ± 2.0°	DL25023 (TJC3D)-2A	
.XXX: ± 0.01	.XX° : ± 1.0°	DR: Chen Quan Long	DATE: 19/08/01
FINISH:		CHKD: Wu Hui	DATE: 19/08/01
DRAWING NO:		APPD: Ren An De	DATE: 19/08/01
		SCALE: N/A	PAGE: 1/1
		UNITS: mm	REV.: A

REV.	REVISION DESCRIPTION	DATE	APPD

NOTES

Available in 03 through 15 Circuits.
 Mates with DL25023-Y Series Housing.
 Material : Nylon UL94V-0(2) .
 0.64mm Square Pin.
 Pin Material : Brass / Tin-Plated.

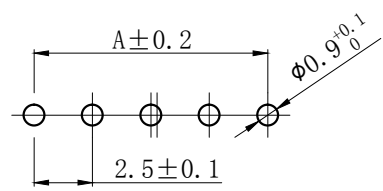
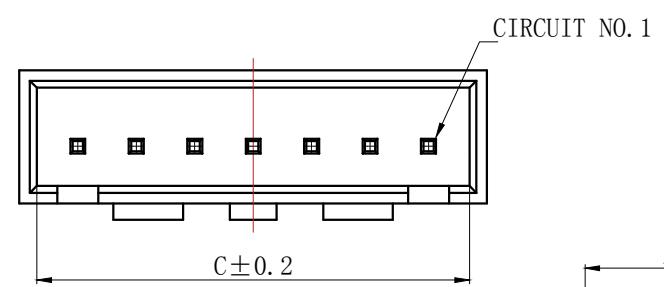
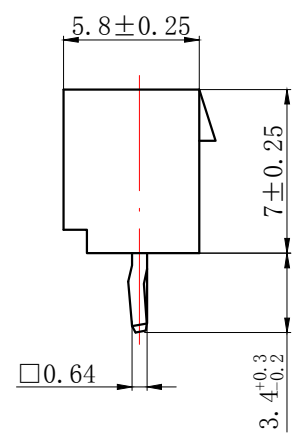
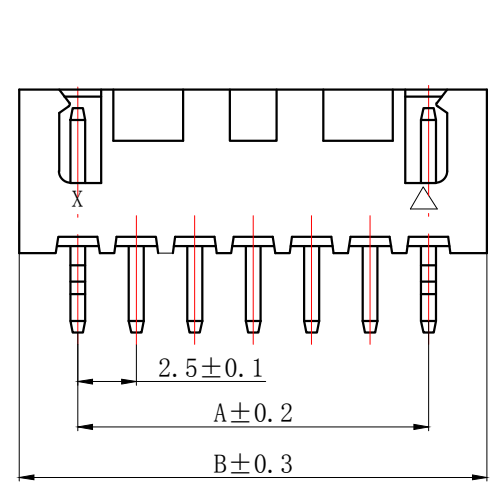
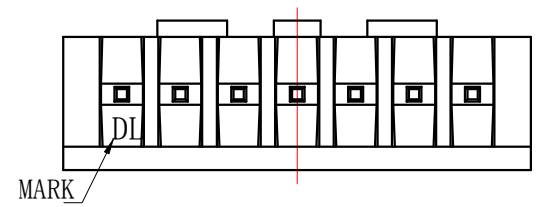

PCB LAYOUT

Circuits	Product name	Dimension mm			Circuits	Product name	Dimension mm		
		A	B	C			A	B	C
3	TJC3D-3A	5.00	10.00	8.50	10	TJC3D-10A	22.50	27.50	26.00
4	TJC3D-4A	7.50	12.50	11.00	11	TJC3D-11A	25.00	30.00	28.50
5	TJC3D-5A	10.00	15.00	13.50	12	TJC3D-12A	27.50	32.50	31.00
6	TJC3D-6A	12.50	17.50	16.00	13	TJC3D-13A	30.00	35.00	33.50
7	TJC3D-7A	15.00	20.00	18.50	14	TJC3D-14A	32.50	37.50	36.00
8	TJC3D-8A	17.50	22.50	21.00	15	TJC3D-15A	35.00	40.00	38.50
9	TJC3D-9A	20.00	25.00	23.50					

GENERAL TOLERANCES (UNLESS SPECIFIED)		ZHE JIANG DELI CONNECTORS CO., LTD	
.X: ± 0.25	X° : ± 3.0°	PRODUCT NAME: DL25023 (TJC3D)-A	TITLE: 2.50 mm Pitch Wire To Board Wafer
.XX: ± 0.15	.X° : ± 2.0°	DR: Chen Quan Long	DATE: 19/08/01
.XXX: ± 0.01	.XX° : ± 1.0°	CHKD: Wu Hui	DATE: 19/08/01
FINISH:		APPD: Ren An De	DATE: 19/08/01
DRAWING NO:		SCALE: N/A	PAGE: 1/1
		UNITS: mm	REV.: A

REV.	REVISION DESCRIPTION	DATE	APPD

NOTES

Available in 02 Circuits.
 Mates with DL25023-Y Series Housing.
 Material : Nylon UL94V-0(2).
 0.64mm Square Pin.
 Pin Material : Brass / Tin-Plated.

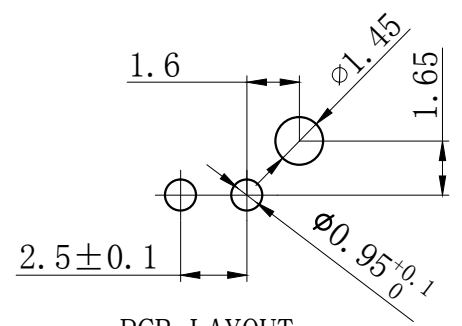
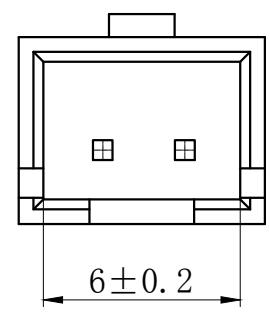

PCB LAYOUT

GENERAL TOLERANCES (UNLESS SPECIFIED)		ZHE JIANG DELI CONNECTORS CO., LTD	
.X: ± 0.25	X° : ± 3.0°	PRODUCT NAME:	TITLE: 2.50 mm Pitch Wire To Board Wafer
.XX: ± 0.15	.X° : ± 2.0°	DL25023(TJC3D)-2AS	
.XXX: ± 0.01	.XX° : ± 1.0°	DR: Chen Quan Long	DATE:19/08/01
FINISH:		CHKD: Wu Hui	DATE:19/08/01
DRAWING NO:		APPD:Ren An De	DATE:19/08/01
		SCALE: N/A	PAGE: 1/1
		UNITS: mm	REV.: A

REV.	REVISION DESCRIPTION	DATE	APPD

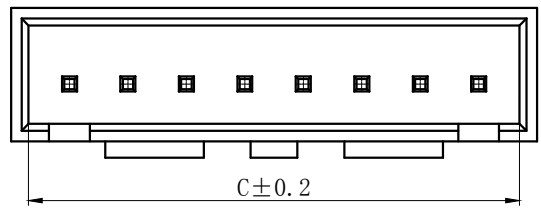
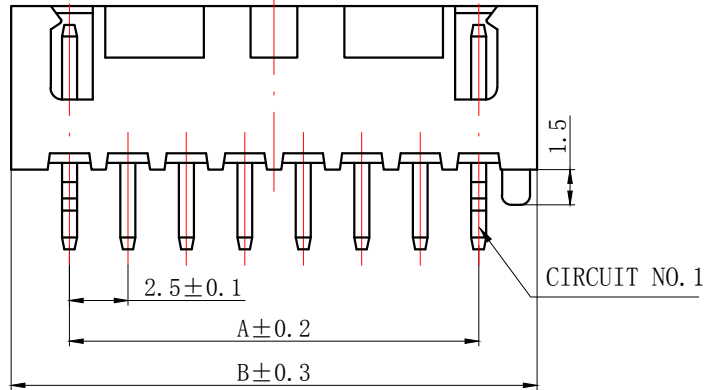
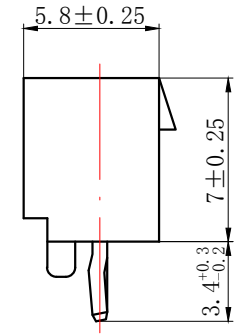

NOTES

Available in 03 through 15 Circuits.
 Mates with DL25023-Y Series Housing.
 Material : Nylon UL94V-0(2).
 0.64mm Square Pin.
 Pin Material : Brass / Tin-Plated.

Circuits	Product name	Dimension mm			Circuits	Product name	Dimension mm		
		A	B	C			A	B	C
3	TJC3D-3AS	5.00	10.00	8.50	10	TJC3D-10AS	22.50	27.50	26.00
4	TJC3D-4AS	7.50	12.50	11.00	11	TJC3D-11AS	25.00	30.00	28.50
5	TJC3D-5AS	10.00	15.00	13.50	12	TJC3D-12AS	27.50	32.50	31.00
6	TJC3D-6AS	12.50	17.50	16.00	13	TJC3D-13AS	30.00	35.00	33.50
7	TJC3D-7AS	15.00	20.00	18.50	14	TJC3D-14AS	32.50	37.50	36.00
8	TJC3D-8AS	17.50	22.50	21.00	15	TJC3D-15AS	35.00	40.00	38.50
9	TJC3D-9AS	20.00	25.00	23.50	-	-	-	-	-

GENERAL TOLERANCES (UNLESS SPECIFIED)		ZHE JIANG DELI CONNECTORS CO., LTD	
.X: ±0.25	X°: ±3.0°	PRODUCT NAME:	TITLE: 2.50 mm Pitch Wire To Board Wafer
.XX: ±0.15	.X°: ±2.0°	DL25023 (TJC3D)-AS	
.XXX: ±0.01	.XX°: ±1.0°	DR: Chen Quan Long	DATE:19/08/01
FINISH:		CHKD: Wu Hui	DATE:19/08/01
DRAWING NO:		APPD:Ren An De	DATE:19/08/01
		SCALE: N/A	PAGE: 1/1
		UNITS: mm	REV.: A

REV.	REVISION DESCRIPTION	DATE	APPD

NOTES

Available in 02 Circuits.

Mates with DL25023-Y Series Housing.

Material : Nylon UL94V-0(2).

0.64mm Square Pin.

Pin Material : Brass / Tin-Plated.

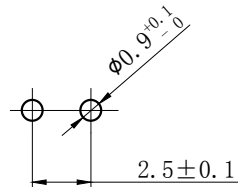
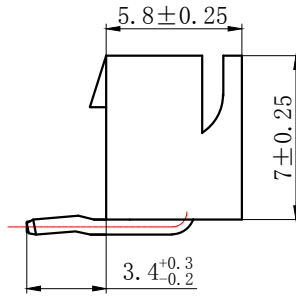

PCB LAYOUT

GENERAL TOLERANCES (UNLESS SPECIFIED)		ZHE JIANG DELI CONNECTORS CO., LTD			
.X: ±0.25	X°: ±3.0°	PRODUCT NAME: DL25023 (TJC3D)-2AW		TITLE: 2.50 mm Pitch Wire To Board Wafer	
.XX: ±0.15	.X°: ±2.0°	DR: Yuan Jun Rong	DATE:19/08/01	PART NO: DL25023-2W-XXX-XX-X-XX	
.XXX: ±0.01	.XX°: ±1.0°	CHKD: Wu Hui	DATE:19/08/01	SCALE: N/A	PAGE: 1/1
FINISH:		APPD: Ren An De	DATE:19/08/01	UNITS: mm	REV.: A
DRAWING NO: GC-DL25023-2W-XXX-XX-X-XX					

REV.	REVISION DESCRIPTION	DATE	APPD

A
B
C
D
E
F

A
B
C
D
E
F

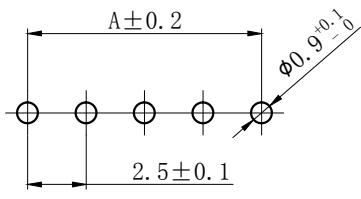
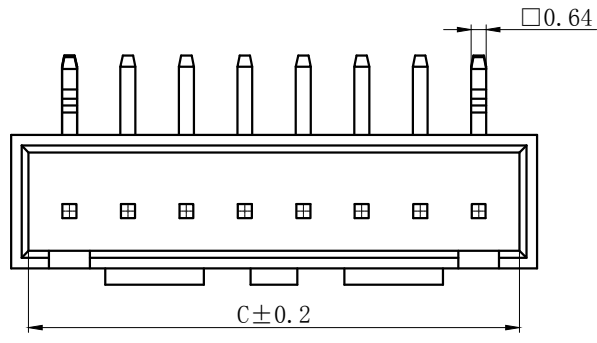
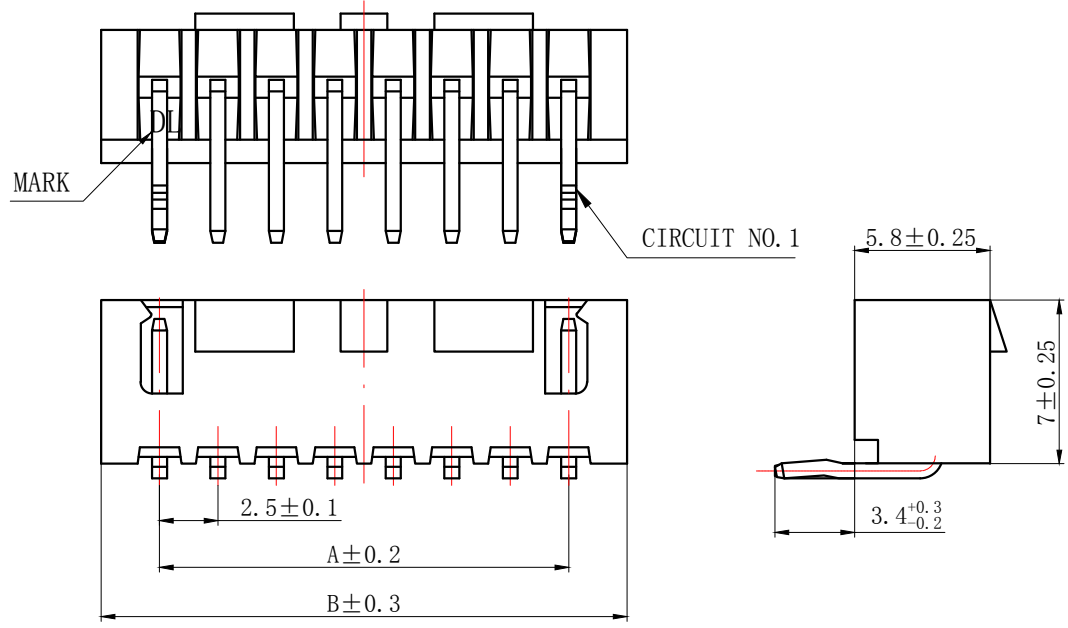

PCB LAYOUT

NOTES

Available in 03 through 15 Circuits.
 Mates with DL25023-Y Series Housing.
 Material : Nylon UL94V-0(2).
 0.64mm Square Pin.
 Pin Material : Brass / Tin-Plated.

Circuits	Product name	Dimension mm			Circuits	Product name	Dimension mm		
		A	B	C			A	B	C
3	TJC3D-3AW-K	5.00	10.00	8.50	10	TJC3D-10AW-K	22.50	27.50	26.00
4	TJC3D-4AW-K	7.50	12.50	11.00	11	TJC3D-11AW-K	25.00	30.00	28.50
5	TJC3D-5AW-K	10.00	15.00	13.50	12	TJC3D-12AW-K	27.50	32.50	31.00
6	TJC3D-6AW-K	12.50	17.50	16.00	13	TJC3D-13AW-K	30.00	35.00	33.50
7	TJC3D-7AW-K	15.00	20.00	18.50	14	TJC3D-14AW-K	32.50	37.50	36.00
8	TJC3D-8AW-K	17.50	22.50	21.00	15	TJC3D-15AW-K	35.00	40.00	38.50
9	TJC3D-9AW-K	20.00	25.00	23.50					

GENERAL TOLERANCES (UNLESS SPECIFIED)		ZHE JIANG DELI CONNECTORS CO., LTD			
.X: ±0.25	X°: ±3.0°	PRODUCT NAME: DL25023 (TJC3D)-AW-K		TITLE: 2.50 mm Pitch Wire To Board Wafer	
.XX: ±0.15	.X°: ±2.0°	DR: Yuan Jun Rong	DATE:19/08/01	PART NO:	
.XXX: ±0.01	.XX°: ±1.0°	CHKD: Wu Hui	DATE:19/08/01	SCALE: N/A	PAGE: 1/1
DRAWING NO:		APPD:Ren An De	DATE:19/08/01	UNITS: mm	REV.: A

1 2 3 4 5 6 7 8

REV.	REVISION DESCRIPTION	DATE	APPD

NOTES

Available in 022 Circuits.

Mates with DL25023-Y Series Housing.

Material : Nylon UL94V-0(2).

0.64mm Square Pin.

Pin Material : Brass / Tin-Plated.

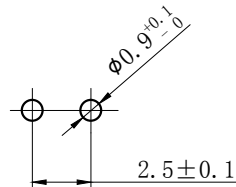
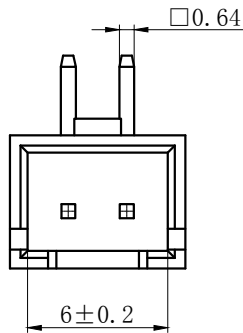
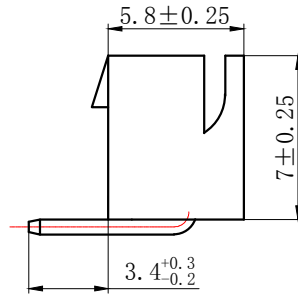

PCB LAYOUT

GENERAL TOLERANCES (UNLESS SPECIFIED)		ZHE JIANG DELI CONNECTORS CO., LTD	
.X: ±0.25	X°: ±3.0°	PRODUCT NAME:	TITLE: 2.50 mm Pitch Wire To Board Wafer
.XX: ±0.15	.X°: ±2.0°	DL25023(TJC3D)-2AW-Z	
.XXX: ±0.01	.XX°: ±1.0°	DR: Chen Quan Long	DATE:19/08/01
FINISH:		CHKD: Wu Hui	DATE:19/08/01
DRAWING NO:		APPD:Ren An De	DATE:19/08/01
			SCALE: N/A
			PAGE: 1/1
			UNITS: mm
			REV.: A

REV.	REVISION DESCRIPTION	DATE	APPD



NOTES

Available in 03 through 15 Circuits.
 Mates with DL25023-Y Series Housing.
 Material : Nylon UL94V-0(2).
 0.64mm Square Pin.
 Pin Material : Brass / Tin-Plated.

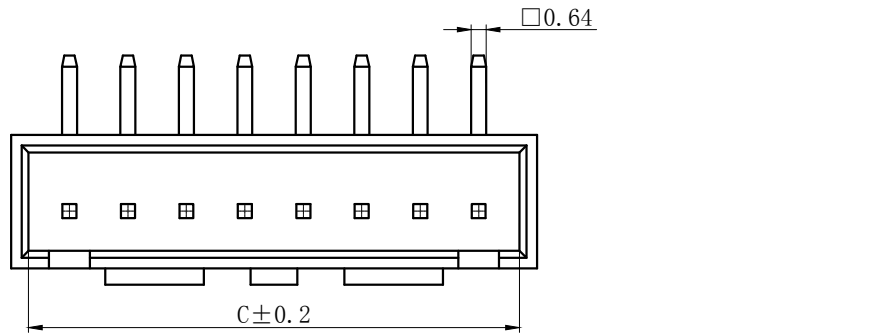

Circuits	Product name	Dimension mm			Circuits	Product name	Dimension mm		
		A	B	C			A	B	C
3	TJC3D-3AW-Z	5.00	10.00	8.50	10	TJC3D-10AW-Z	22.50	27.50	26.00
4	TJC3D-4AW-Z	7.50	12.50	11.00	11	TJC3D-11AW-Z	25.00	30.00	28.50
5	TJC3D-5AW-Z	10.00	15.00	13.50	12	TJC3D-12AW-Z	27.50	32.50	31.00
6	TJC3D-6AW-Z	12.50	17.50	16.00	13	TJC3D-13AW-Z	30.00	35.00	33.50
7	TJC3D-7AW-Z	15.00	20.00	18.50	14	TJC3D-14AW-Z	32.50	37.50	36.00
8	TJC3D-8AW-Z	17.50	22.50	21.00	15	TJC3D-15AW-Z	35.00	40.00	38.50
9	TJC3D-9AW-Z	20.00	25.00	23.50					

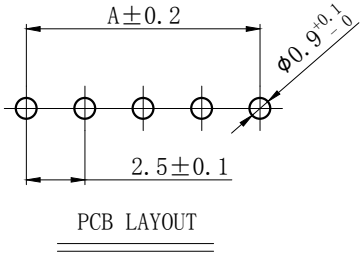

GENERAL TOLERANCES (UNLESS SPECIFIED)		ZHE JIANG DELI CONNECTORS CO., LTD	
.X: ±0.25	X° : ± 3.0°	PRODUCT NAME:	TITLE: 2.50 mm Pitch Wire To Board Wafer
.XX: ± 0.15	.X° : ± 2.0°	DL25023 (TJC3D)-AW-Z	
.XXX: ± 0.01	.XX° : ± 1.0°	DR: Chen Quan Long	DATE:19/08/01
FINISH:		CHKD: Wu Hui	DATE:19/08/01
DRAWING NO:		APPD:Ren An De	DATE:19/08/01
			PART NO:
			SCALE: N/A
			PAGE: 1/1
			UNITS: mm
			REV. : A

REV.	REVISION DESCRIPTION	DATE	APPD

NOTES

Available in 02 Circuits.

Mates with DL25023-Y Series Housing.

Material : Nylon UL94V-0(2).

0.64mm Square Pin.

Pin Material : Brass / Tin-Plated.

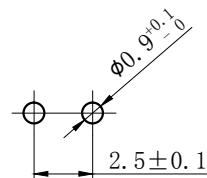
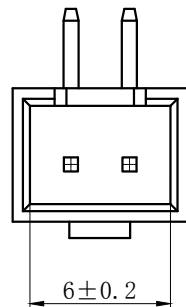
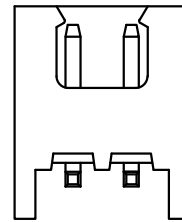
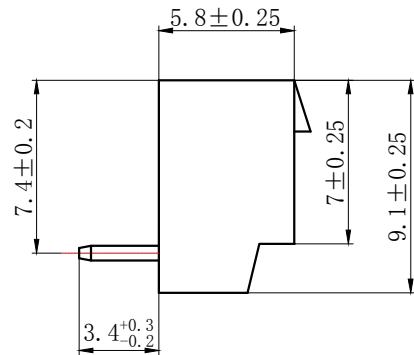
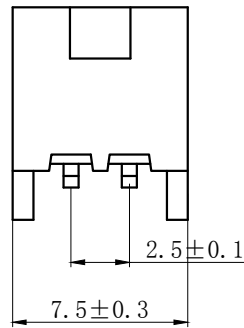
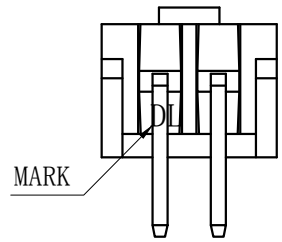

PCB LAYOUT

GENERAL TOLERANCES (UNLESS SPECIFIED)		ZHE JIANG DELI CONNECTORS CO., LTD	
.X: ±0.25	X°: ±3.0°	PRODUCT NAME:	TITLE: 2.50 mm Pitch Wire To Board Wafer
.XX: ±0.15	.X°: ±2.0°	DL25023 (TJC3D)-2AWD-Z	
.XXX: ±0.01	.XX°: ±1.0°	DR: Chen Quan Long	DATE:19/08/01
FINISH:		CHKD: Wu Hui	DATE:19/08/01
DRAWING NO:		APPD:Ren An De	DATE:19/08/01
			PART NO:
			SCALE: N/A
			PAGE: 1/1
			UNITS: mm
			REV.: A

REV.	REVISION DESCRIPTION	DATE	APPD

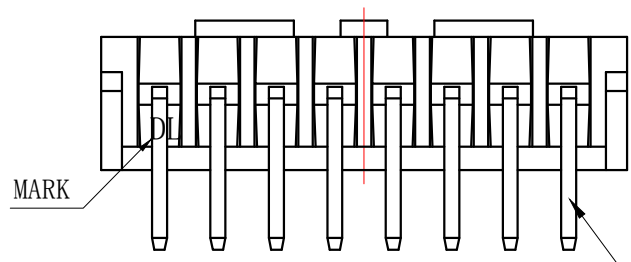

CIRCUIT NO. 1

NOTES

Available in 03 through 15 Circuits.
 Mates with DL25023-Y Series Housing.
 Material : Nylon UL94V-0(2).
 0.64mm Square Pin.
 Pin Material : Brass / Tin-Plated.

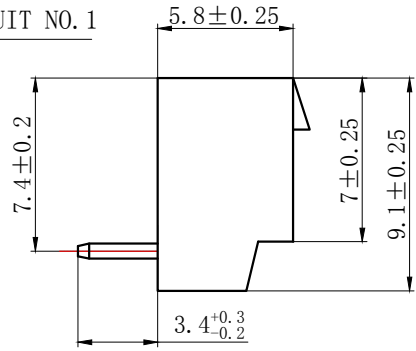
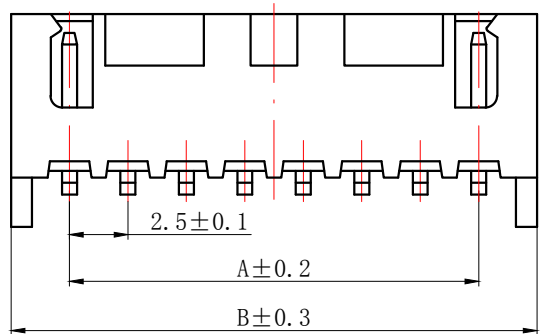

Circuits	Product name	Dimension mm			Circuits	Product name	Dimension mm		
		A	B	C			A	B	C
3	TJC3D-3AWD-Z	5.00	10.00	8.50	10	TJC3D-10AWD-Z	22.50	27.50	26.00
4	TJC3D-4AWD-Z	7.50	12.50	11.00	11	TJC3D-11AWD-Z	25.00	30.00	28.50
5	TJC3D-5AWD-Z	10.00	15.00	13.50	12	TJC3D-12AWD-Z	27.50	32.50	31.00
6	TJC3D-6AWD-Z	12.50	17.50	16.00	13	TJC3D-13AWD-Z	30.00	35.00	33.50
7	TJC3D-7AWD-Z	15.00	20.00	18.50	14	TJC3D-14AWD-Z	32.50	37.50	36.00
8	TJC3D-8AWD-Z	17.50	22.50	21.00	15	TJC3D-15AWD-Z	35.00	40.00	38.50
9	TJC3D-9AWD-Z	20.00	25.00	23.50					

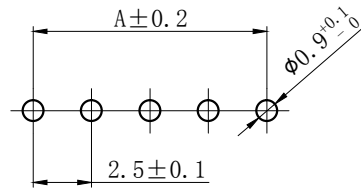

PCB LAYOUT

GENERAL TOLERANCES (UNLESS SPECIFIED)		ZHE JIANG DELI CONNECTORS CO., LTD	
.X: ±0.25	X° : ± 3.0°	PRODUCT NAME:	TITLE: 2.50 mm Pitch Wire To Board Wafer
.XX: ± 0.15	.X° : ± 2.0°	DL25023 (TJC3D)-AWD-Z	
.XXX: ± 0.01	.XX° : ± 1.0°	DR: Chen Quan Long	DATE:19/08/01
FINISH:		CHKD: Wu Hui	DATE:19/08/01
DRAWING NO:		APPD:Ren An De	DATE:19/08/01
			PART NO:
			SCALE: N/A
			PAGE: 1/1
			UNITS: mm
			REV. : A

REV.	REVISION DESCRIPTION	DATE	APPD

NOTES

Available in 02 Circuits.
 Mates with DL25023-Y Series Housing.
 Material : Nylon UL94V-0(2).
 0.64mm Square Pin.
 Pin Material : Brass / Tin-Plated.

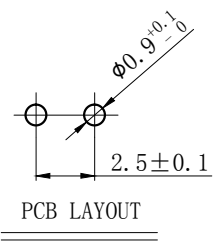
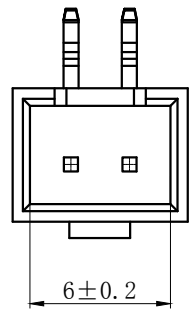
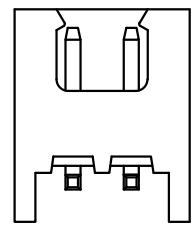

GENERAL TOLERANCES (UNLESS SPECIFIED)		ZHE JIANG DELI CONNECTORS CO., LTD	
.X: ±0.25	X°: ±3.0°	PRODUCT NAME: DL25023 (TJC3D)-2AWD-K	TITLE: 2.50 mm Pitch Wire To Board Wafer
.XX: ±0.15	.X°: ±2.0°	DR: Chen Quan Long	DATE:19/08/01
.XXX: ±0.01	.XX°: ±1.0°	CHKD: Wu Hui	DATE:19/08/01
FINISH: _____		APPD:Ren An De	DATE:19/08/01
DRAWING NO:		SCALE: N/A	PAGE: 1/1
		UNITS: mm	REV.: A

REV.	REVISION DESCRIPTION	DATE	APPD



CIRCUIT NO. 1

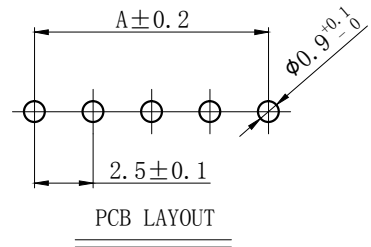
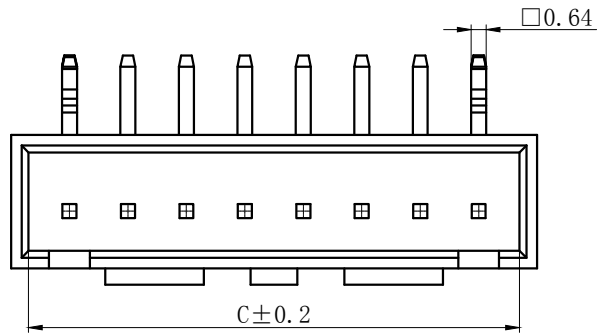

NOTES

Available in 03 through 15 Circuits.
 Mates with DL25023-Y Series Housing.
 Material : Nylon UL94V-0(2).
 0.64mm Square Pin.
 Pin Material : Brass / Tin-Plated.

Circuits	Product name	Dimension mm			Circuits	Product name	Dimension mm		
		A	B	C			A	B	C
3	TJC3D-3AWD-K	5.00	10.00	8.50	10	TJC3D-10AWD-K	22.50	27.50	26.00
4	TJC3D-4AWD-K	7.50	12.50	11.00	11	TJC3D-11AWD-K	25.00	30.00	28.50
5	TJC3D-5AWD-K	10.00	15.00	13.50	12	TJC3D-12AWD-K	27.50	32.50	31.00
6	TJC3D-6AWD-K	12.50	17.50	16.00	13	TJC3D-13AWD-K	30.00	35.00	33.50
7	TJC3D-7AWD-K	15.00	20.00	18.50	14	TJC3D-14AWD-K	32.50	37.50	36.00
8	TJC3D-8AWD-K	17.50	22.50	21.00	15	TJC3D-15AWD-K	35.00	40.00	38.50
9	TJC3D-9AWD-K	20.00	25.00	23.50					

GENERAL TOLERANCES (UNLESS SPECIFIED)		ZHE JIANG DELI CONNECTORS CO., LTD	
.X: ±0.25	.X°: ±3.0°	PRODUCT NAME:	TITLE: 2.50 mm Pitch Wire To Board Wafer
.XX: ±0.15	.X°: ±2.0°	DL25023 (TJC3D)-AWD-K	
.XXX: ±0.01	.XX°: ±1.0°	DR: Chen Quan Long	DATE:19/08/01
FINISH:		CHKD: Wu Hui	DATE:19/08/01
DRAWING NO:		APPD:Ren An De	DATE:19/08/01
			PART NO:
			SCALE: N/A
			PAGE: 1/1
			UNITS: mm
			REV.: A

REV.	REVISION DESCRIPTION	DATE	APPD



NOTES

Available in 02 through 15 Circuits.
 Mates with DL25023-Y Series Housing.
 Material : Nylon UL94V-0(2).
 0.64mm Square Pin.
 Pin Material : Brass / Tin-Plated.

Circuits	Product name	Dimension mm			Circuits	Product name	Dimension mm		
		A	B	C			A	B	C
2	TJC3D-2AWF	2.50	7.50	6.50	9	TJC3D-9AWF	20.00	25.00	23.50
3	TJC3D-3AWF	5.00	10.00	8.50	10	TJC3D-10AWF	22.50	27.50	26.00
4	TJC3D-4AWF	7.50	12.50	11.00	11	TJC3D-11AWF	25.00	30.00	28.50
5	TJC3D-5AWF	10.00	15.00	13.50	12	TJC3D-12AWF	27.50	32.50	31.00
6	TJC3D-6AWF	12.50	17.50	16.00	13	TJC3D-13AWF	30.00	35.00	33.50
7	TJC3D-7AWF	15.00	20.00	18.50	14	TJC3D-14AWF	32.50	37.50	36.00
8	TJC3D-8AWF	17.50	22.50	21.00	15	TJC3D-15AWF	35.00	40.00	38.50

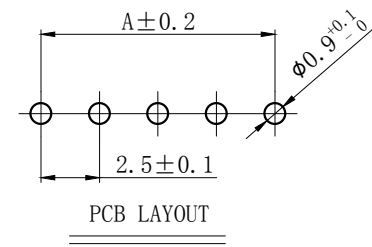

GENERAL TOLERANCES (UNLESS SPECIFIED)		ZHE JIANG DELI CONNECTORS CO., LTD	
.X: ± 0.25	X° : ± 3.0°	PRODUCT NAME: DL25023 (TJC3D)-AWF	TITLE: 2.50 mm Pitch Wire To Board Wafer
.XX: ± 0.15	.X° : ± 2.0°	DR: Chen Quan Long	DATE:19/08/01
.XXX: ± 0.01	.XX° : ± 1.0°	CHKD: Wu Hui	DATE:19/08/01
FINISH:		APPD:Ren An De	DATE:19/08/01
DRAWING NO:			
		SCALE: N/A	PAGE: 1/1
		UNITS: mm	REV.: A

REV.	REVISION DESCRIPTION	DATE	APPD



NOTES

Available in 02 through 15 Circuits.
 Match with DL25023 series housing
 Material : Nylon UL94V-0(2).
 Accepts DL25023-T Crimp Terminal.

Circuits	Product name	Dimension mm				Circuits	Product name	Dimension mm			
		A	B	C	D			A	B	C	D
2	TJC3D-2Y	2.50	7.00	5.70	5.30	10	TJC3D-10Y	22.50	27.00	25.70	15.1
3	TJC3D-3Y	5.00	9.50	8.20	5.10	11	TJC3D-11Y	25.00	29.50	28.20	15.1
4	TJC3D-4Y	7.50	12.00	10.70	5.10	12	TJC3D-12Y	27.50	32.00	30.70	15.1
5	TJC3D-5Y	10.00	14.50	13.20	7.60	13	TJC3D-13Y	30.00	34.50	33.20	15.1
6	TJC3D-6Y	12.50	17.00	15.70	10.10	14	TJC3D-14Y	32.50	37.00	35.70	15.1
7	TJC3D-7Y	15.00	19.50	18.20	12.60	15	TJC3D-15Y	35.00	39.50	38.20	15.1
8	TJC3D-8Y	17.50	22.00	20.70	15.10	-	-	-	-	-	-
9	TJC3D-9Y	20.00	24.50	23.20	17.60	-	-	-	-	-	-

GENERAL TOLERANCES (UNLESS SPECIFIED)		ZHE JIANG DELI CONNECTORS CO., LTD	
.X: ± 0.25	X° : ± 3.0°	PRODUCT NAME: DL25023 (TJC3D)-Y	TITLE: 2.50 mm Pitch Housing
.XX: ± 0.15	.X° : ± 2.0°	DR: Chen Quan Long	DATE: 19/08/01
.XXX: ± 0.01	.XX° : ± 1.0°	CHKD: Wu Hui	DATE: 19/08/01
FINISH:		APPD: Ren An De	DATE: 19/08/01
DRAWING NO:		UNITS: mm	SCALE: N/A
			PAGE: 1/1
			REV.: A

REV.	REVISION DESCRIPTION	DATE	APPD

NOTES

Available in 02 through 20 Circuits.
 Match with DL25023-Y series housing
 Material : Nylon UL94V-0(2).
 Accepts DL25023-RT Crimp Terminal.

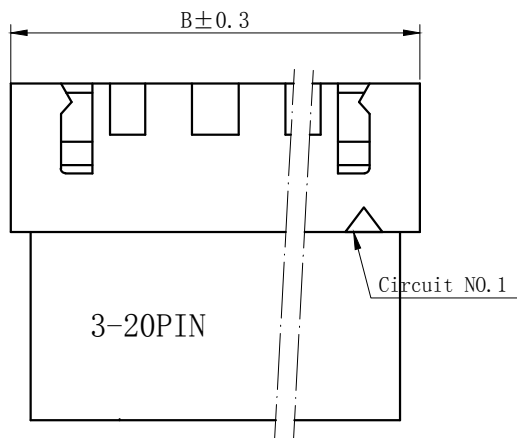
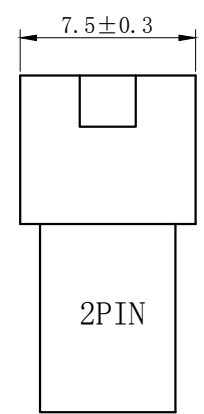

Circuits	Product name	Dimension mm			Circuits	Product name	Dimension mm		
		A	B	C			A	B	C
2	TJC3D-2R	2.50	7.50	6.00	10	TJC3D-10R	22.50	27.50	26.00
3	TJC3D-3R	5.00	10.00	8.50	11	TJC3D-11R	25.00	30.00	28.50
4	TJC3D-4R	7.50	12.50	11.00	12	TJC3D-12R	27.50	32.50	31.00
5	TJC3D-5R	10.00	15.00	13.50	13	TJC3D-13R	30.00	35.00	33.50
6	TJC3D-6R	12.50	17.50	16.00	14	TJC3D-14R	32.50	37.50	36.00
7	TJC3D-7R	15.00	20.00	18.50	15	TJC3D-15R	35.00	40.00	38.50
8	TJC3D-8R	17.50	22.50	21.00	-	-	-	-	-
9	TJC3D-9R	20.00	25.00	23.50	20	TJC3D-20R	47.50	52.50	51.00

GENERAL TOLERANCES (UNLESS SPECIFIED)		ZHE JIANG DELI CONNECTORS CO., LTD	
.X: ± 0.25	X° : ± 3.0°	PRODUCT NAME:	TITLE: 2.50 mm Pitch Wire To Wire Housing
.XX: ± 0.15	.X° : ± 2.0°	DL25023 (TJC3D)-R	PART NO:
.XXX: ± 0.01	.XX° : ± 1.0°	DR:Chen Quan Long	
FINISH:		CHKD: Wu Hui	DATE:20/12/30
DRAWING NO:		APPD:Ren An De	DATE:20/12/30
		SCALE: N/A	PAGE: 1/1
		UNITS: mm	REV.: A

REV.	REVISION DESCRIPTION	DATE	APPD

NOTES

Available in 02 through 20 Circuits.
 Match with DL25001-Y series housing
 Material : Nylon UL94V-0(2).



Circuits	Product name	Dimension mm		Circuits	Product name	Dimension mm	
		A	B			A	B
2	TJC3-2S	2.50	8.7	9	TJC3-9S	20.00	26.2
3	TJC3-3S	5.00	11.2	10	TJC3-10S	22.50	28.7
4	TJC3-4S	7.50	13.7	11	TJC3-11S	25.00	31.2
5	TJC3-5S	10.00	16.2	12	TJC3-12S	27.50	33.7
6	TJC3-6S	12.50	18.7	13	TJC3-13S	30.00	36.2
7	TJC3-7S	15.00	21.2	~	~	~	~
8	TJC3-8S	17.50	23.7	20	TJC3-20S	47.80	53.7

GENERAL TOLERANCES (UNLESS SPECIFIED)		ZHE JIANG DELI CONNECTORS CO., LTD			
.X: ± 0.25	X°: ± 3.0°	PRODUCT NAME: DL25001(TJC3)-S		TITLE: 2.50 mm Pitch Housing	
.XX: ± 0.15	.X°: ± 2.0°	DR: Yuan Jun Rong	DATE:21/03/18	PART NO:	
.XXX: ± 0.01	.XX°: ± 1.0°	CHKD: Wu Hui	DATE:21/03/18	SCALE: N/A	PAGE: 1/1
FINISH:		APPD: Ren An De	DATE:21/03/18	UNITS: mm	REV.: A
DRAWING NO:					

REV.	REVISION DESCRIPTION	DATE	APPD



NOTES

Used in DL25001-Y Series Housing.
 Accepts AWG #24~20 Wire Range.
 Material : Phosphor Bronze .
 Finish: Tin plated.
 Thickness: 0.2 mm.



GENERAL TOLERANCES (UNLESS SPECIFIED)				ZHE JIANG DELI CONNECTORS CO., LTD			
.X: ± 0.25	X°: ± 3.0°	PRODUCT NAME: DL25001(TJC3)-T-G		TITLE: 2.50 mm Pitch Crimp Terminal		PART NO:	
.XX: ± 0.15	.X°: ± 2.0°	DR: Chen Quan Long	DATE: 19/08/01	SCALE: N/A		PAGE: 1/1	
.XXX: ± 0.01	.XX°: ± 1.0°	CHKD: Wu Hui	DATE: 19/08/01	UNITS: mm		REV.: A	
DRAWING NO:		APPD: Ren An De	DATE: 19/08/01				

REV.	REVISION DESCRIPTION	DATE	APPD

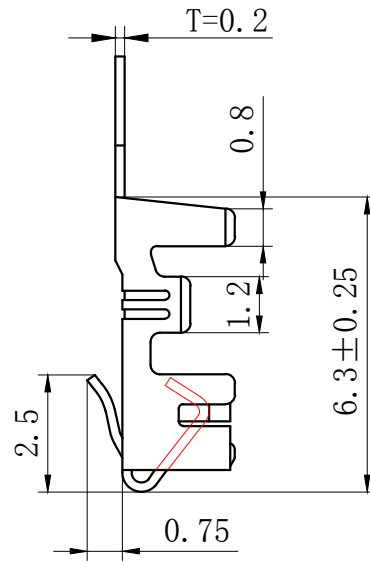
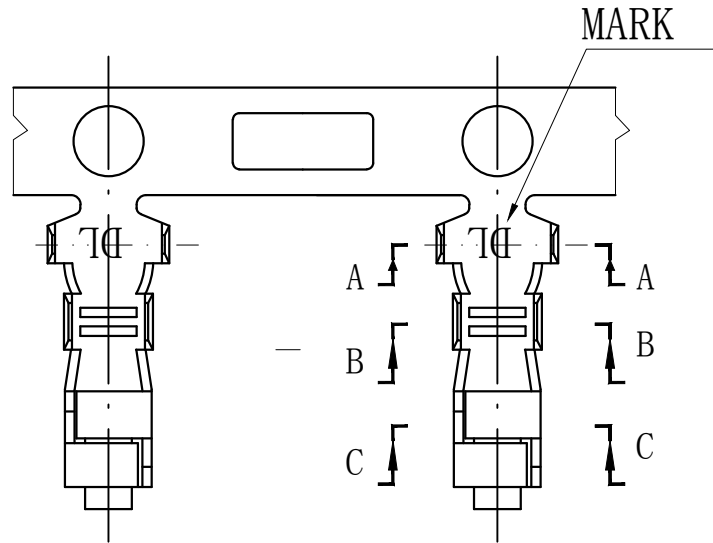

NOTES

Used in DL25001-Y Series Housing.
Accepts AWG #28~22 Wire Range.

0.08~ 0.33 mm² .

Insulation O.D.=1.2~1.9 mm.

Material : Phosphor Bronze .

Finish: Tin plated.

Thickness: 0.2 mm.

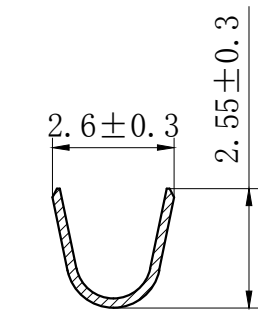

SECTION A-A

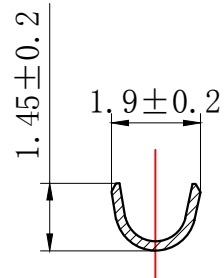

SECTION B-B

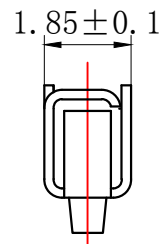

SECTION C-C

GENERAL TOLERANCES (UNLESS SPECIFIED)		ZHE JIANG DELI CONNECTORS CO., LTD	
.X: ± 0.25	X° : ± 3.0°	PRODUCT NAME: DL25001 (TJC3)-T	TITLE: 2.50 mm Pitch Crimp Terminal
.XX: ± 0.15	.X° : ± 2.0°	DR: Chen Quan Long	DATE: 19/08/01
.XXX: ± 0.01	.XX° : ± 1.0°	CHKD: Wu Hui	DATE: 19/08/01
FINISH:		APPD: Ren An De	DATE: 19/08/01
DRAWING NO:		SCALE: N/A	PAGE: 1/1
		UNITS: mm	REV.: A

REV.	REVISION DESCRIPTION	DATE	APPD

NOTES

Used in DL25002-R Series Housing.
Accepts AWG #28~22 Wire Range.

0.08~ 0.33 mm² .

Insulation O.D. =1.2~1.9 mm.

Material : Phosphor Bronze .

Finish: Tin plated.

Thickness: 0.2 mm.

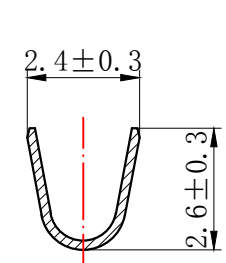
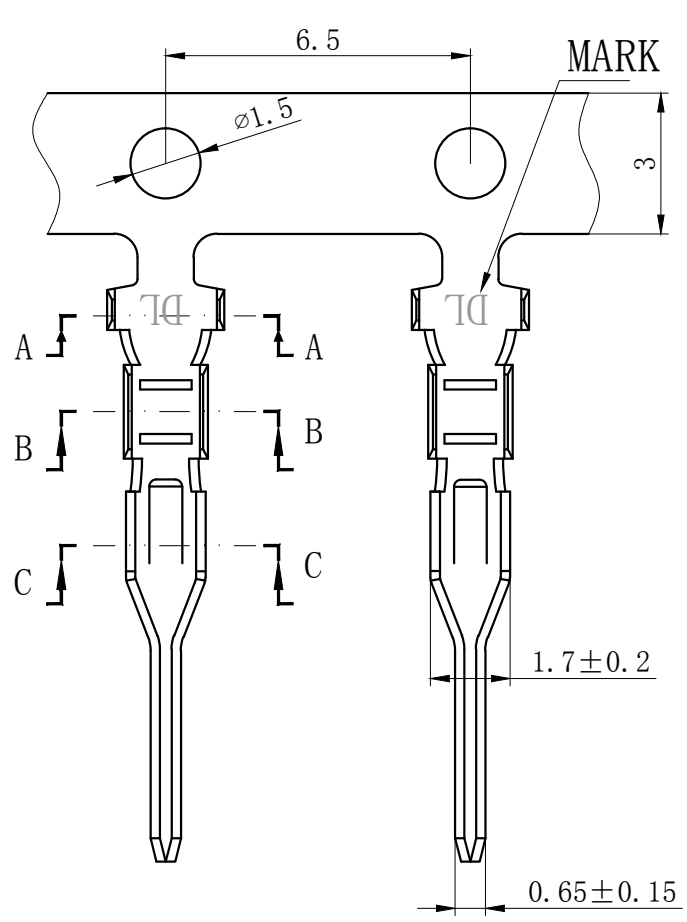

SECTION A-A



SECTION B-B



SECTION C-C

GENERAL TOLERANCES (UNLESS SPECIFIED)				ZHE JIANG DELI CONNECTORS CO., LTD			
.X: ± 0.25	X°: ± 3.0°	PRODUCT NAME: DL25002 (TJC3B)-RT		TITLE: 2.50 mm Pitch Wire To Wire Terminal			
.XX: ± 0.15	.X°: ± 2.0°	DR: Chen Quan Long	DATE: 20/12/30	PART NO:			
.XXX: ± 0.01	.XX°: ± 1.0°	CHKD: Wu Hui	DATE: 20/12/30	SCALE: N/A	PAGE: 1/1		
DRAWING NO:		APPD: Ren An De	DATE: 20/12/30	UNITS: mm	REV.: A		

X-ON Electronics

Largest Supplier of Electrical and Electronic Components

Click to view similar products for [Headers & Wire Housings](#) category:

Click to view products by [DLL](#) manufacturer:

Other Similar products are found below :

[0015917161](#) [0022155065](#) [57102-F02-18ULF](#) [58102-G61-06LF](#) [582553-1](#) [01.001.5753.1](#) [0050291907](#) [02.125.8002.8](#) [609-3404](#) [61062-3](#)
[CSU011177004](#) [622-0430](#) [622-3653LF](#) [63453-116](#) [636-1030](#) [636-1427](#) [636-3427](#) [636-4007](#) [641938-9](#) [65495-038](#) [65692-001LF](#) [65781-018](#)
[65781-047](#) [65817-010LF](#) [65817-015LF](#) [67095-007LF](#) [67601157](#) [68631-112](#) [68645-018](#) [699319-000](#) [70.362.1628.0](#) [70-4210](#) [70-4226B](#) [70-](#)
[4853B](#) [71.350.2428.0](#) [733-134](#) [733-162](#) [MHR-64-VUAL](#) [80.063.4001.1](#) [800-90-001-10-001000](#) [801-43-002-10-013000](#) [801-43-006-10-](#)
[002000](#) [803-43-024-10-001000](#) [803-93-012-10-001000](#) [8-1437020-4](#) [819-22-004-30-001101](#) [820-22-006-30-001101](#) [820-22-008-30-001101](#)
[821-22-002-10-001101](#) [821-22-003-10-002101](#)