

技术特性/Specifications:

额定电压 Rated voltage: 250V AC, DC
额定电流 Rated current: 7A AC, DC
接触电阻 Contact resistance: 20m Ω max
绝缘电阻 Insulation resistance: 1000M Ω min
耐压 Withstand voltage: 1500V AC/minute
环境温度 Ambient temperature: -40 $^{\circ}$ C~+105 $^{\circ}$ C
适用线规 Wire range: AWG#22~#16

REV.	REVISION DESCRIPTION	DATE	APPD

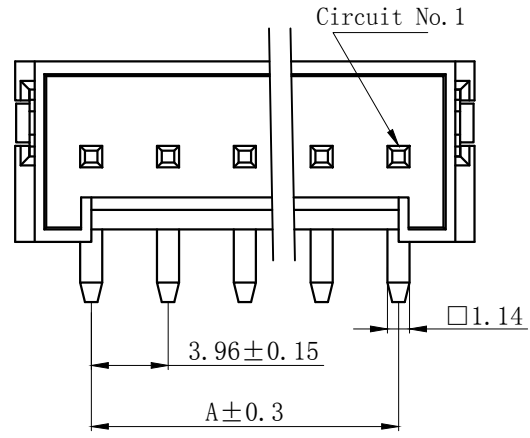
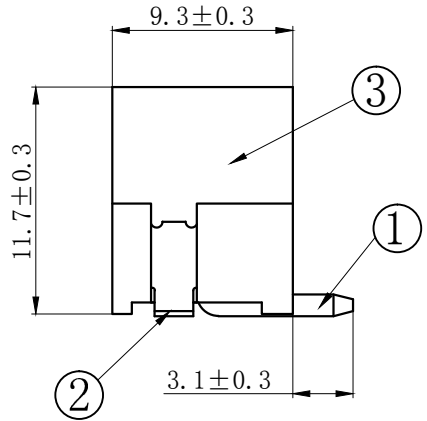
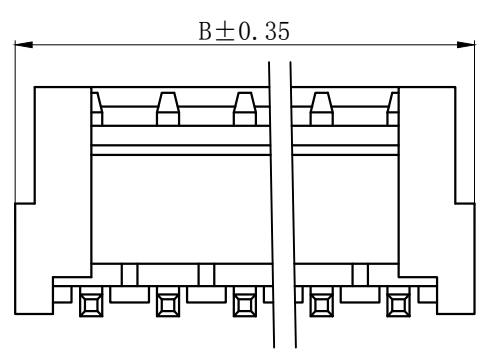

NOTES

Available in 02 through 15 Circuits.
Mates with DL39602-Y Series Housing.
Material : LCP UL94V-0.
Pin Material : Brass.Tin-plated .



Circuits	Product name	Dimension mm		Circuits	Product name	Dimension mm	
		A	B			A	B
2	VH-2AB	3.96	11.88	9	VH-9AB	31.68	39.60
3	VH-3AB	7.92	15.84	10	VH-10AB	35.64	43.56
4	VH-4AB	11.88	19.80	11	VH-11AB	39.60	47.52
5	VH-5AB	15.84	23.76	12	VH-12AB	43.56	51.48
6	VH-6AB	19.80	27.72	13	VH-13AB	47.52	55.44
7	VH-7AB	23.76	31.68	14	VH-14AB	51.48	59.40
8	VH-8AB	27.72	35.64	15	VH-15AB	55.44	63.36

3	③	基座	LCP	1	UL94V-0
2	②	焊片	黄铜	2	镀锡
1	①	接触件	黄铜	N*	镀锡
序号	图号	名称	材料	数量	附件

GENERAL TOLERANCES (UNLESS SPECIFIED)		ZHE JIANG DELI CONNECTORS CO., LTD			
.X: ± 0.25	X°: ± 3.0°	PRODUCT NAME: DL39602 (VH)-AB		TITLE: 3.96 mm Pitch Wire To Board SMT Wafer	
.XX: ± 0.15	.X°: ± 2.0°	DR: Yuan Jun Rong	DATE: 21/06/07	PART NO:	
.XXX: ± 0.01	.XX°: ± 1.0°	CHKD: Wu Hui	DATE: 21/06/07	SCALE: N/A	PAGE: 1/1
DRAWING NO:		APPD: Ren An De	DATE: 21/06/07	UNITS: mm	REV.: A

REV.	REVISION DESCRIPTION	DATE	APPD



NOTES

Available in 02 through 15 Circuits.
Mates with DL39602-Y Series Housing.
Material : LCP UL94V-0.
Pin Material : Brass.Tin-plated .

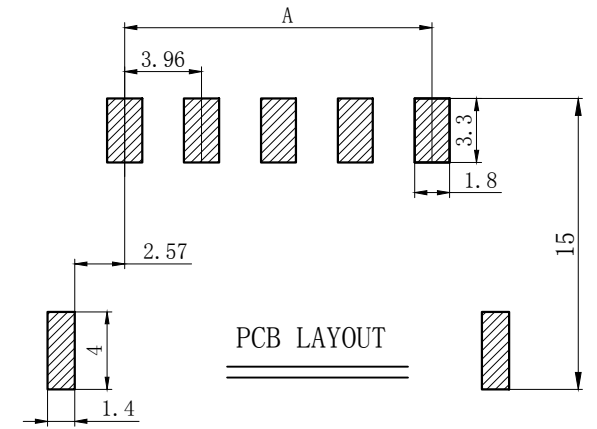

Circuits	Product name	Dimension mm		Circuits	Product name	Dimension mm	
		A	B			A	B
2	VH-2AWB	3.96	11.88	9	VH-9AWB	31.68	39.60
3	VH-3AWB	7.92	15.84	10	VH-10AWB	35.64	43.56
4	VH-4AWB	11.88	19.80	11	VH-11AWB	39.60	47.52
5	VH-5AWB	15.84	23.76	12	VH-12AWB	43.56	51.48
6	VH-6AWB	19.80	27.72	13	VH-13AWB	47.52	55.44
7	VH-7AWB	23.76	31.68	14	VH-14AWB	51.48	59.40
8	VH-8AWB	27.72	35.64	15	VH-15AWB	55.44	63.36

3	③	基座	LCP	1	UL94V-0
2	②	焊片	黄铜	2	镀锡
1	①	接触件	黄铜	N*	镀锡
序号	图号	名称	材料	数量	附件

GENERAL TOLERANCES (UNLESS SPECIFIED)		ZHE JIANG DELI CONNECTORS CO., LTD			
.X: ± 0.25	X°: ± 3.0°	PRODUCT NAME: DL39602 (VH)-AWB		TITLE: 3.96 mm Pitch Wire To Board SMT Wafer	
.XX: ± 0.15	.X°: ± 2.0°	DR: Yuan Jun Rong	DATE: 21/06/07	PART NO:	
.XXX: ± 0.01	.XX°: ± 1.0°	CHKD: Wu Hui	DATE: 21/06/07	SCALE: N/A	PAGE: 1/1
DRAWING NO:		APPD: Ren An De	DATE: 21/06/07	UNITS: mm	REV.: A

REV.	REVISION DESCRIPTION	DATE	APPD
B	调整尺寸公差	20.8.28	

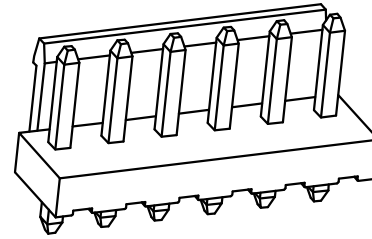
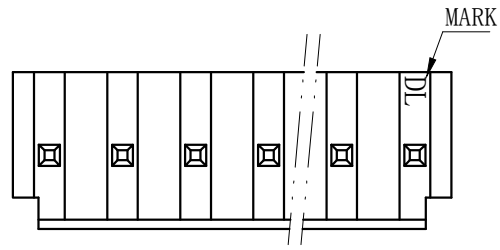

NOTES

Available in 02 through 15 Circuits.
 Mates with DL39602-Y Series Housing.
 Material : Nylon UL94V-0 (2) .
 1.14mm Square Pin.
 Pin Material : Brass / Tin-Plated.

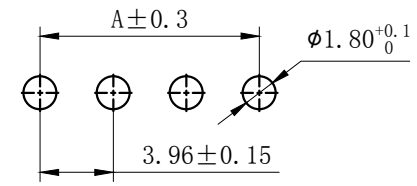
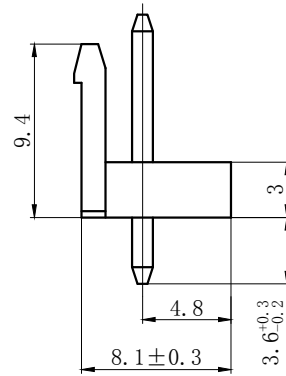
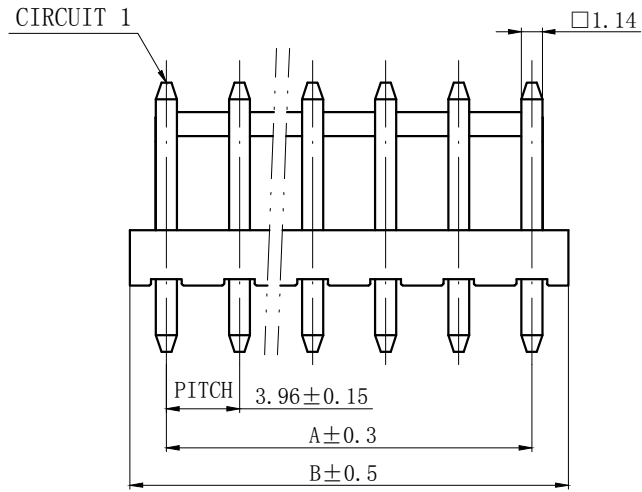

PCB LAYOUT

Circuits	PRODUCT NAME	Dimension mm	
		A	B
02	VH-2A	3.96	7.92
03	VH-3A	7.92	11.88
04	VH-4A	11.88	15.84
05	VH-5A	15.84	19.80
06	VH-6A	19.80	23.76
07	VH-7A	23.76	27.72
08	VH-8A	27.72	31.68
09	VH-9A	31.68	35.64
10	VH-10A	35.64	39.60
11	VH-11A	39.60	43.56
12	VH-12A	43.56	47.52
13	VH-13A	47.52	51.48
14	VH-14A	51.48	55.44
15	VH-15A	55.44	59.40

GENERAL TOLERANCES (UNLESS SPECIFIED)		ZHE JIANG DELI CONNECTORS CO., LTD	
.X: ± 0.25	X°: ± 3.0°	PRODUCT NAME: DL39602 (VH)-A	TITLE: 3.96 mm pitch WTB Connector Housing
.XX: ± 0.15	.X°: ± 2.0°	DR: Yuan Jun Rong	DATE: 21.10.10
.XXX: ± 0.01	.XX°: ± 1.0°	DATE: 21.10.10	PART NO:
FINISH:		CHKD: Wu Hui	DATE: 21.10.10
DRAWING NO:		APPD: Ren An De	DATE: 21.10.10
		SCALE: N/A	PAGE: 1/1
		UNITS: mm	REV.: B

REV.	REVISION DESCRIPTION	DATE	APPD
B	调整尺寸公差	20.8.28	

NOTES

Available in 02 through 15 Circuits.

Mates with DL39602-Y Series Housing.

Material : Nylon UL94V-0(2).

1.14mm Square Pin.

Pin Material : Brass / Tin-Plated.

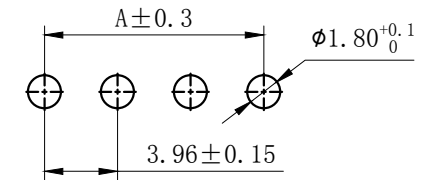
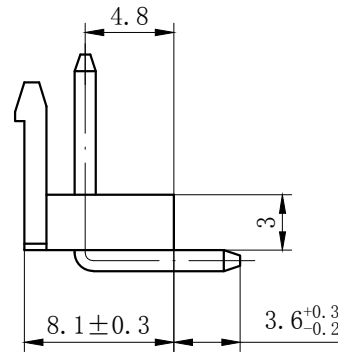
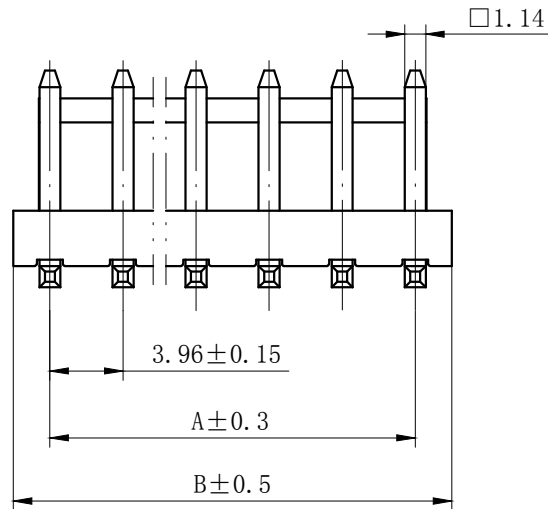
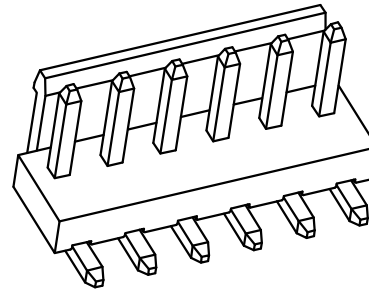
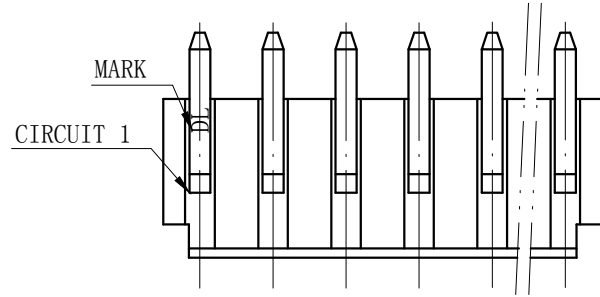

PCB LAYOUT

Circuits	PRODUCT NAME	Dimension mm	
		A	B
02	VH-2AW	3.96	7.92
03	VH-3AW	7.92	11.88
04	VH-4AW	11.88	15.84
05	VH-5AW	15.84	19.80
06	VH-6AW	19.80	23.76
07	VH-7AW	23.76	27.72
08	VH-8AW	27.72	31.68
09	VH-9AW	31.68	35.64
10	VH-10AW	35.64	39.60
11	VH-11AW	39.60	43.56
12	VH-12AW	43.56	47.52
13	VH-13AW	47.52	51.48
14	VH-14AW	51.48	55.44
15	VH-15AW	55.44	59.40

GENERAL TOLERANCES (UNLESS SPECIFIED)		ZHE JIANG DELI CONNECTORS CO., LTD	
.X: ± 0.25	X°: ± 3.0°	PRODUCT NAME: DL39602 (VH)-AW	TITLE: 3.96 mm pitch WTB Connector Housing
.XX: ± 0.15	.X°: ± 2.0°	DR: Yuan Jun Rong	DATE: 21.10.10
.XXX: ± 0.01	.XX°: ± 1.0°	CHKD: Wu Hui	DATE: 21.10.10
FINISH:		APPD: LIU BING	DATE: 21.10.10
DRAWING NO:		PART NO:	
		SCALE: N/A	PAGE: 1/1
		UNITS: mm	REV.: B

REV.	REVISION DESCRIPTION	DATE	APPD
B	调整尺寸公差	20. 8. 28	

NOTES

Available in 02 through 15 Circuits.

Mates with DL39602-Y Series Housing.

Material : Nylon UL94V-0(2).

1.14mm Square Pin.

Pin Material : Brass / Tin-Plated.

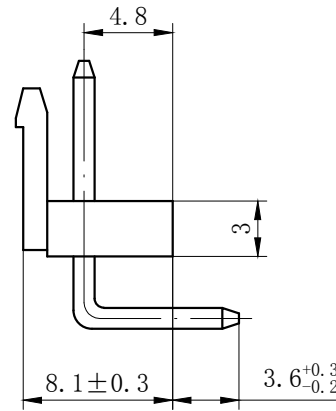
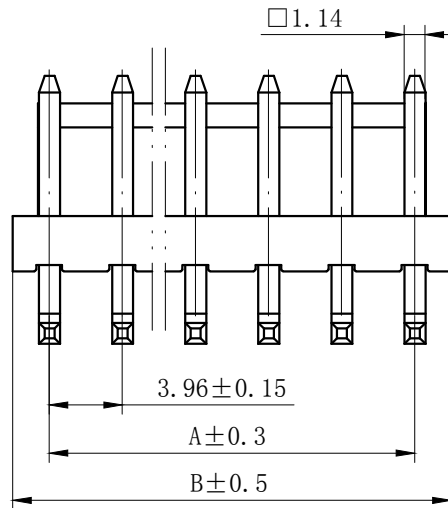

Circuits	Product name	Dimensino (mm)	
		A	B
2	VH-2AWT	3.96	7.92
3	VH-3AWT	7.92	11.88
4	VH-4AWT	11.88	15.84
5	VH-5AWT	15.84	19.80
6	VH-6AWT	19.80	23.76
7	VH-7AWT	23.76	27.72
8	VH-8AWT	27.72	31.68
9	VH-9AWT	31.68	35.64
10	VH-10AWT	35.64	39.60
11	VH-11AWT	39.60	43.56
12	VH-12AWT	43.56	47.52
13	VH-13AWT	47.52	51.48
14	VH-14AWT	51.48	55.44
15	VH-15AWT	55.44	59.40

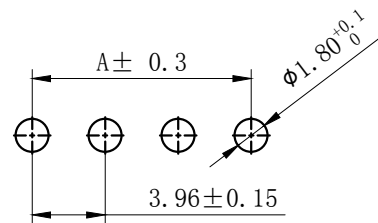

PCB LAYOUT

GENERAL TOLERANCES (UNLESS SPECIFIED)		ZHE JIANG DELI CONNECTORS CO., LTD	
.X: ± 0.25	X°: ± 3.0°	PRODUCT NAME:	TITLE: 3.96 mm pitch WTB Connector Housing
.XX: ± 0.15	.X°: ± 2.0°	DL39602 (VH)-AWT	
.XXX: ± 0.01	.XX°: ± 1.0°	DR: Yuan Jun Rong	DATE: 21.10.10
FINISH:		CHKD: Wu Hui	DATE: 21.10.10
DRAWING NO:		APPD: Ren An De	DATE: 21.10.10
			PART NO:
			SCALE: N/A
			PAGE: 1/1
			UNITS: mm
			REV.: B

REV.	REVISION DESCRIPTION	DATE	APPD
B	调整尺寸公差	20. 8. 28	

NOTES

Available in 02 through 15 Circuits.

Mates with DL39602-Y Series Housing.

Material : Nylon UL94V-0(2)

1.14mm Square Pin.

Pin Material : Brass / Tin-Plated.

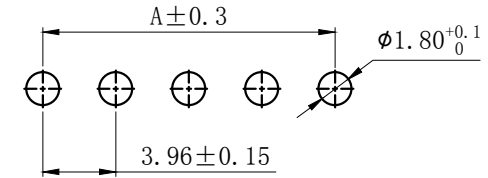
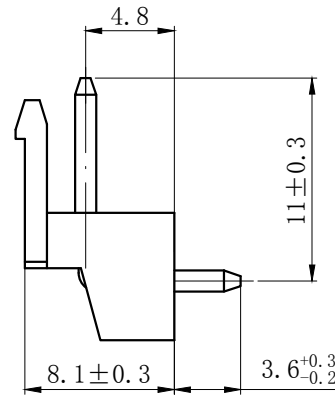
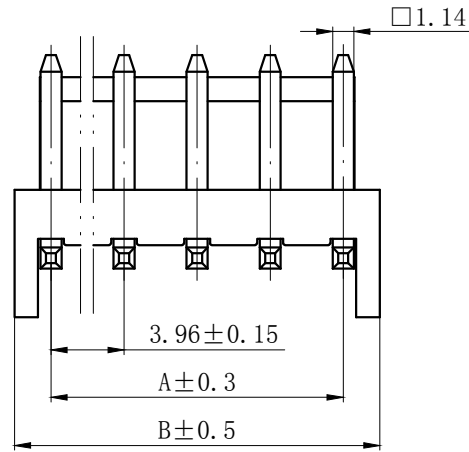
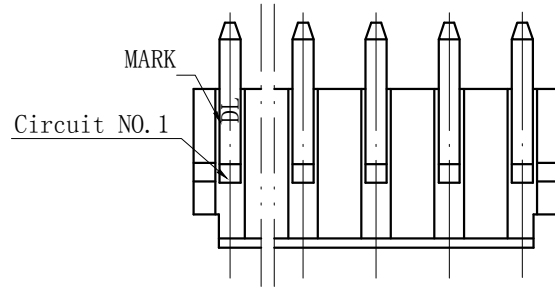

PCB LAYOUT

Circuits	PRODUCT NAME	Dimension mm	
		A	B
02	VH-2AWD	3.96	7.92
03	VH-3AWD	7.92	11.88
04	VH-4AWD	11.88	15.84
05	VH-5AWD	15.84	19.80
06	VH-6AWD	19.80	23.76
07	VH-7AWD	23.76	27.72
08	VH-8AWD	27.72	31.68
09	VH-9AWD	31.68	35.64
10	VH-10AWD	35.64	39.60
11	VH-11AWD	39.60	43.56
12	VH-12AWD	43.56	47.52
13	VH-13AWD	47.52	51.48
14	VH-14AWD	51.48	55.44
15	VH-15AWD	55.44	59.40

GENERAL TOLERANCES (UNLESS SPECIFIED)		ZHE JIANG DELI CONNECTORS CO., LTD	
.X: ± 0.25	X°: ± 3.0°	PRODUCT NAME: DL39602 (VH)-AWD	
.XX: ± 0.15	.X°: ± 2.0°	TITLE: 3.96 mm pitch WTB Connector Housing	
.XXX: ± 0.01	.XX°: ± 1.0°	DR: Yuan Jun Rong	DATE: 21.10.10
FINISH:		CHKD: Wu Hui	DATE: 21.10.10
DRAWING NO:		APPD: Ren An De	DATE: 21.10.10
		PART NO:	
		SCALE: N/A	PAGE: 1/1
		UNITS: mm	REV.: B

REV.	REVISION DESCRIPTION	DATE	APPD
B	调整尺寸公差	20.8.28	

NOTES

Available in 02 through 15 Circuits.

Mates with DL39602-Y Series Housing.

Material : Nylon UL94V-0(2)

1.14mm Square Pin.

Pin Material : Brass / Tin-Plated.

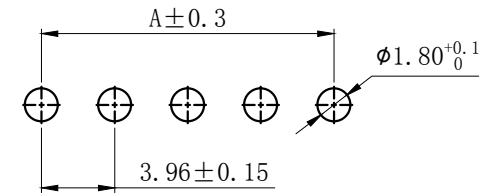
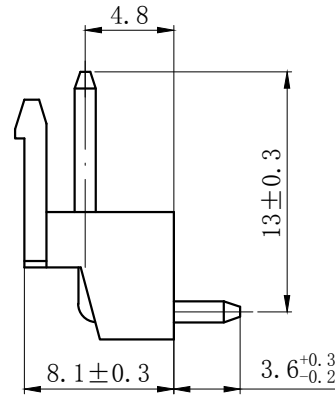
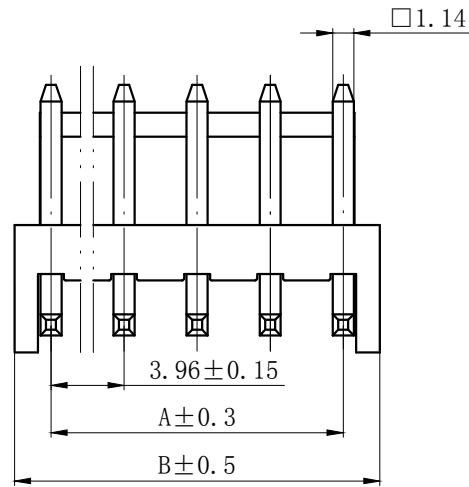
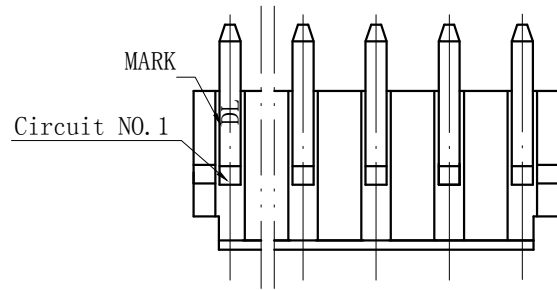

PCB LAYOUT

Circuits	PRODUCT NAME	Dimension mm	
		A	B
02	VH-2AWF	3.96	7.92
03	VH-3AWF	7.92	11.88
04	VH-4AWF	11.88	15.84
05	VH-5AWF	15.84	19.80
06	VH-6AWF	19.80	23.76
07	VH-7AWF	23.76	27.72
08	VH-8AWF	27.72	31.68
09	VH-9AWF	31.68	35.64
10	VH-10AWF	35.64	39.60
11	VH-11AWF	39.60	43.56
12	VH-12AWF	43.56	47.52
13	VH-13AWF	47.52	51.48
14	VH-14AWF	51.48	55.44
15	VH-15AWF	55.44	59.40

GENERAL TOLERANCES (UNLESS SPECIFIED)		ZHE JIANG DELI CONNECTORS CO., LTD	
.X: ± 0.25	X°: ± 3.0°	PRODUCT NAME: DL39602 (VH)-AWF	
.XX: ± 0.15	.X°: ± 2.0°	TITLE: 3.96 mm pitch WTB Connector Housing	
.XXX: ± 0.01	.XX°: ± 1.0°	DR: Yuan Jun Rong	DATE: 21.10.10
FINISH: _____		CHKD: Wu Hui	DATE: 21.10.10
DRAWING NO: _____		APPD: Ren An De	DATE: 21.10.10
		PART NO:	
		SCALE: N/A	PAGE: 1/1
		UNITS: mm	REV.: B

REV.	REVISION DESCRIPTION	DATE	APPD
B	调整尺寸公差	20.8.28	Wu Hui

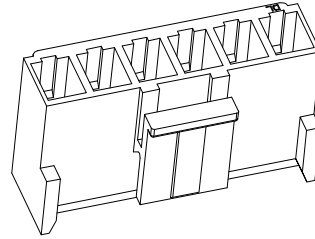
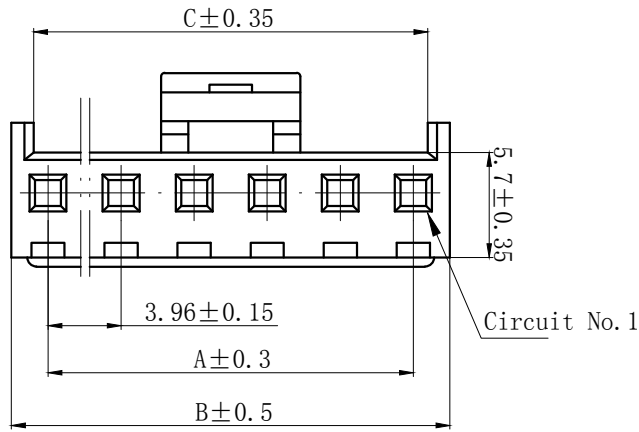

NOTES

Available in 02 through 15 Circuits.
Mates with DL39602 Series Housing.
Material : Nylon UL94V-0 (2)
Accepts DL39602-T Crimp Terminal.

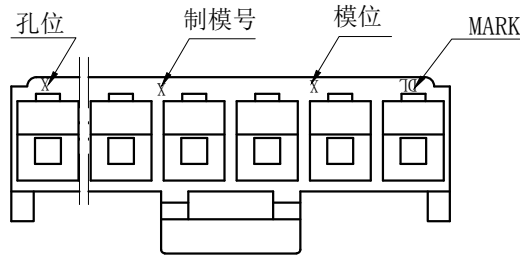
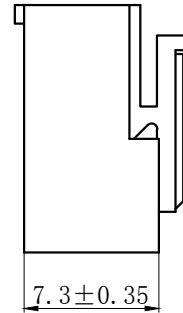
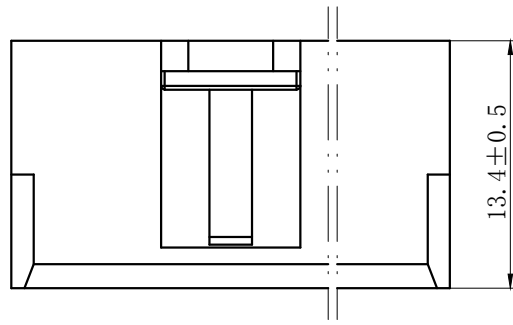

Circuits	Product name	Dimension mm			Circuits	Product name	Dimension mm		
		A	B	C			A	B	C
2	VH-2Y	3.96	7.92	5.52	9	VH-9Y	31.68	35.64	33.24
3	VH-3Y	7.92	11.88	9.48	10	VH-10Y	35.64	39.60	37.20
4	VH-4Y	11.88	15.84	13.44	11	VH-11Y	39.60	43.56	41.16
5	VH-5Y	15.84	19.80	17.40	12	VH-12Y	43.56	47.52	45.12
6	VH-6Y	19.80	23.76	21.36	13	VH-13Y	47.52	51.48	49.08
7	VH-7Y	23.76	27.72	25.32	14	VH-14Y	51.48	55.44	53.04
8	VH-8Y	27.72	31.68	29.28	15	VH-15Y	55.44	59.40	57.00

GENERAL TOLERANCES (UNLESS SPECIFIED)				ZHE JIANG DELI CONNECTORS CO., LTD			
.X: ± 0.25	X°: ± 3.0°	PRODUCT NAME: DL39602 (VH)-Y		TITLE: 3.96 mm Pitch Connector Housing			
.XX: ± 0.15	.X°: ± 2.0°	DR: Chen Quan Long	DATE: 21.10.10	PART NO:			
.XXX: ± 0.01	.XX°: ± 1.0°	CHKD: Wu Hui	DATE: 21.10.10	SCALE: N/A		PAGE: 1/1	
FINISH:		APPD: Ren An De	DATE: 21.10.10	UNITS: mm		REV.: B	

REV.	REVISION DESCRIPTION	DATE	APPD

A

B

C

D

E

F

A

B

C

D

E

F

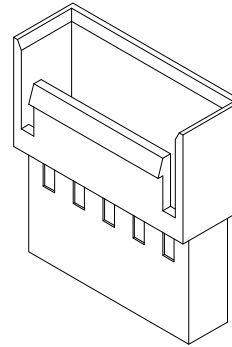
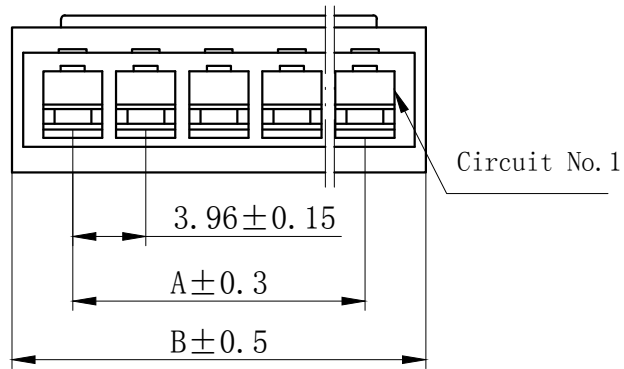

NOTES

Available in 02 through 15 Circuits.

Mates with DL39602-Y Housing.

Material : Nylon UL94V-0(2).

Accepts DL39602-RT Crimp Terminal.

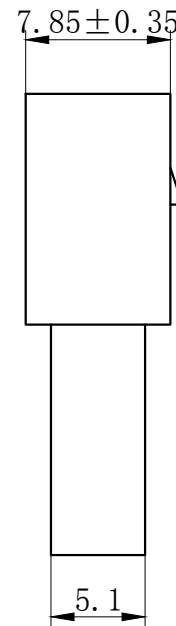
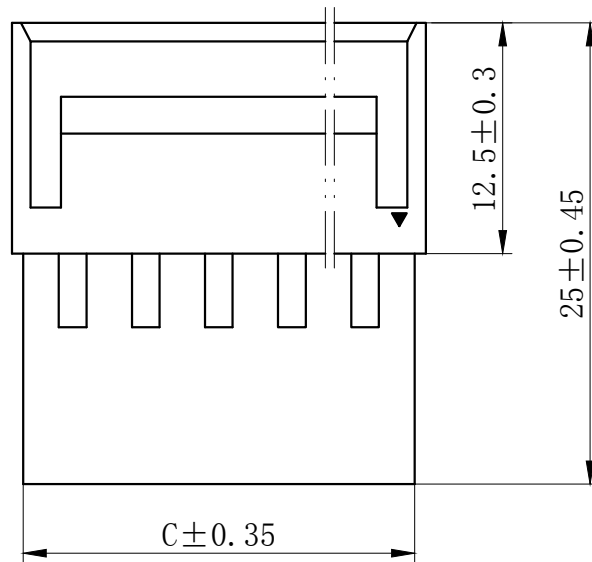

Circuits	Product name	Dimension mm			Circuits	Product name	Dimension mm		
		A	B	C			A	B	C
2	VH-2R	3.96	10.54	9.34	9	VH-9R	31.68	38.26	37.06
3	VH-3R	7.92	14.50	13.30	10	VH-10R	35.64	42.22	41.02
4	VH-4R	11.88	18.46	17.26	11	VH-11R	39.60	46.18	44.98
5	VH-5R	15.84	22.42	21.22	12	VH-12R	43.56	50.14	48.94
6	VH-6R	19.80	26.38	25.18	13	VH-13R	47.52	54.10	52.90
7	VH-7R	23.76	30.34	29.14	14	VH-14R	51.48	58.06	56.86
8	VH-8R	27.72	34.30	33.10	15	VH-15R	55.44	62.02	60.82

GENERAL TOLERANCES
(UNLESS SPECIFIED)

.X: ± 0.25 X°: ± 3.0°
.XX: ± 0.15 .X°: ± 2.0°
.XXX: ± 0.01 .XX°: ± 1.0°

FINISH:

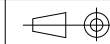

DRAWING NO:

ZHE JIANG DELI CONNECTORS CO., LTD

PRODUCT NAME:
DL39602 (VH)-R

TITLE:
3.96 mm Pitch
Wire To Wire Housing

DR: Chen Quan Long DATE: 21.10.10

PART NO:

CHKD: Wu Hui DATE: 21.10.10

SCALE: N/A PAGE: 1/1

APPD: Ren An De DATE: 21.10.10

UNITS: mm REV.: A

1

2

3

4

5

6

7

8

REV.	REVISION DESCRIPTION	DATE	APPD

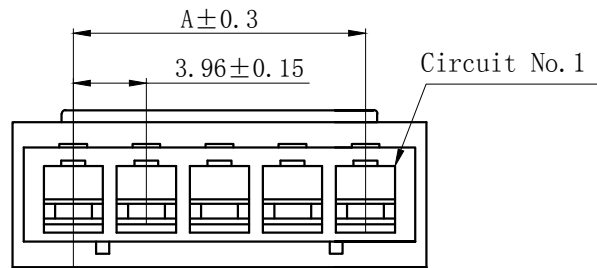

NOTES

Available in 05.07 Circuits.

Mates with DL39602-Y Housing.

Material : Nylon UL94V-0(2).

Accepts DL39602-RT Crimp Terminal.

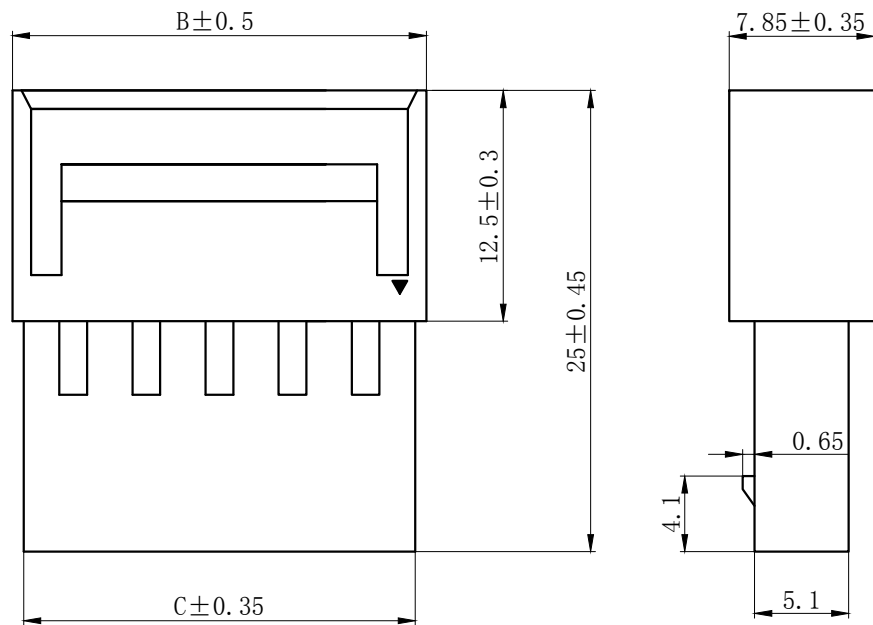

Circuits	Product name	Dimension mm		
		A	B	C
5	VH-5RK	15.84	22.42	21.22
7	VH-7RK	23.76	30.34	29.14

GENERAL TOLERANCES (UNLESS SPECIFIED)		ZHE JIANG DELI CONNECTORS CO., LTD	
.X: ± 0.25	X°: ± 3.0°	PRODUCT NAME: DL39602 (VH)-RK	TITLE: 3.96 mm Pitch Wire To Wire Housing
.XX: ± 0.15	.X°: ± 2.0°	DR: Chen Quan Long	DATE: 22.10.10
.XXX: ± 0.01	.XX°: ± 1.0°	CHKD: Wu Hui	DATE: 22.10.10
FINISH:		APPD: Ren An De	DATE: 22.10.10
DRAWING NO:		SCALE: N/A	PAGE: 1/1
		UNITS: mm	REV.: A

REV.	REVISION DESCRIPTION	DATE	APPD
B.	优化: 加长线扣定位柱到线端卡扣槽底部	2023. 8. 28	Wu Hui

MARK

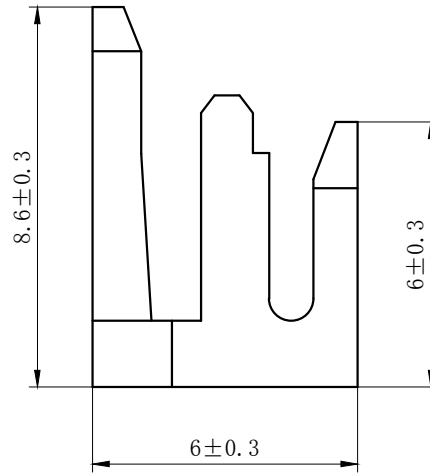
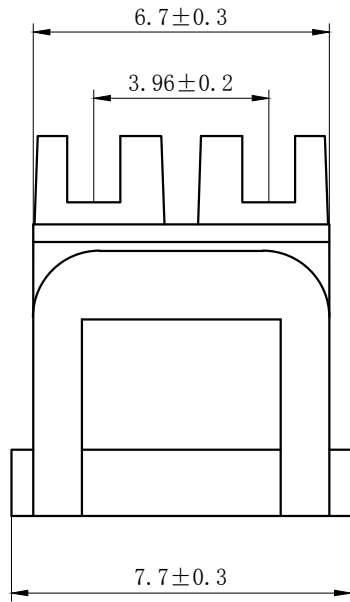
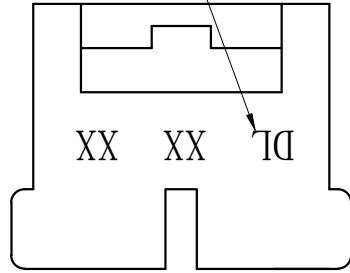

NOTES

Available in 02 Circuits.

Mates with DL39602-Y Series Housing.

Material : Nylon UL94V-0(2).

GENERAL TOLERANCES (UNLESS SPECIFIED)		ZHE JIANG DELI CONNECTORS CO., LTD	
.X: ± 0.25	X° : ± 3.0°	PRODUCT NAME:	TITLE: 3.96 mm pitch WTB Connector Housing
.XX: ± 0.15	.X° : ± 2.0°	DR: Yuan Jun Rong	DATE: 11.10.10
.XXX: ± 0.01	.XX° : ± 1.0°	DATE: 11.10.10	PART NO:
FINISH:		CHKD: Wu Hui	DATE: 11.10.10
DRAWING NO:		APPD: Ren An De	DATE: 11.10.10
		SCALE: N/A	PAGE: 1/2
		UNITS: mm	REV.: B

REV.	REVISION DESCRIPTION	DATE	APPD
B.	优化: 加长线扣定位柱到线端卡扣槽底部	2023. 8. 28	Wu Hui

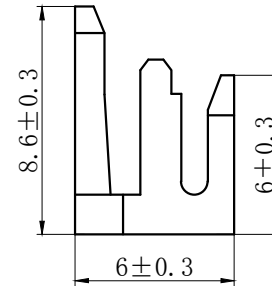
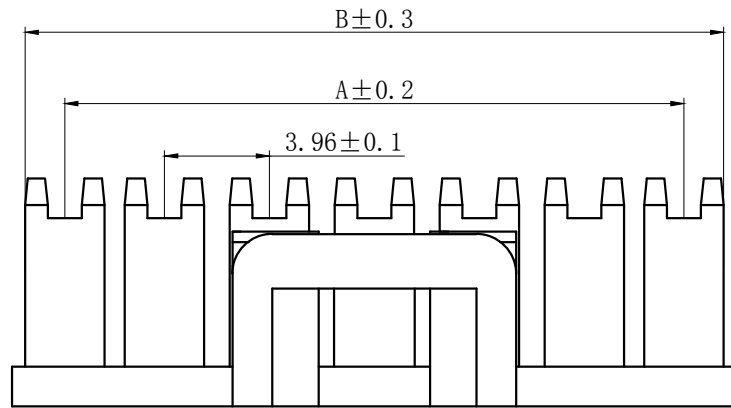
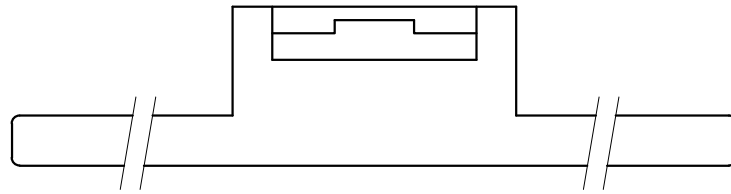

NOTES

Available in 03 through 11 Circuits.
Mates with DL39602-Y Series Housing.

Material : Nylon UL94V-0(2).

Circuits	Product name	Dimensino (mm)	
		A	B
3	VH-3S	7.60	10.60
4	VH-4S	11.48	14.48
5	VH-5S	15.44	18.44
6	VH-6S	19.40	22.40
7	VH-7S	23.36	26.36
8	VH-8S	27.32	30.32
9	VH-9S	31.28	34.28
10	VH-10S	35.24	38.24
11	VH-11S	39.20	42.20

GENERAL TOLERANCES (UNLESS SPECIFIED)		ZHE JIANG DELI CONNECTORS CO., LTD	
.X: ± 0.25	X° : ± 3.0°	PRODUCT NAME:	TITLE: 3.96 mm pitch WTB Connector Housing
.XX: ± 0.15	.X° : ± 2.0°	DR: Yuan Jun Rong	DATE: 11.10.10
.XXX: ± 0.01	.XX° : ± 1.0°	DATE: 11.10.10	SCALE: N/A
FINISH:		CHKD: Wu Hui	DATE: 11.10.10
DRAWING NO:		APPD: Ren An De	DATE: 11.10.10
			PAGE: 2/2
			UNITS: mm
			REV.: B

1

2

3

4

5

6

7

8

REV.	REVISION DESCRIPTION	DATE	APPD

A

A

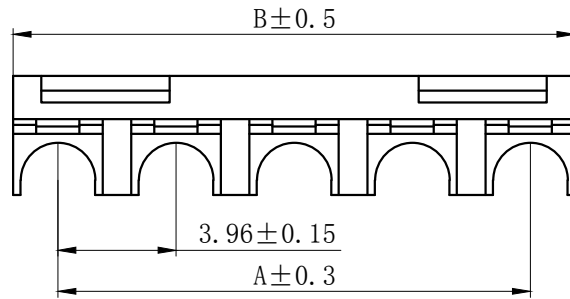

B

B

NOTES

Available in 05.07 Circuits.

Mates with DL39602-RK Series Housing.

Material : Nylon UL94V-0(2).

C

C

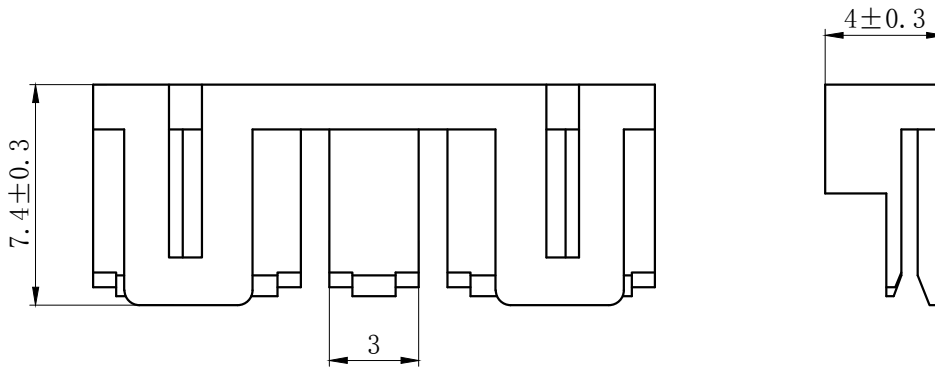

D

D

E

E

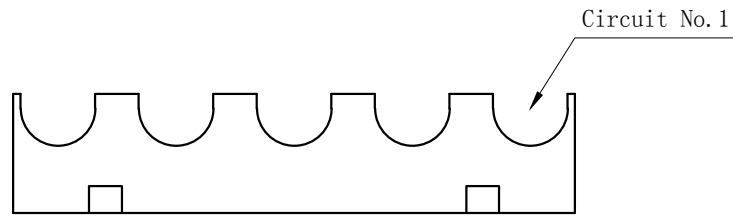

Circuits	Product name	Dimension mm	
		A	B
5	VH-5RS	15.84	18.84
7	VH-7RS	23.76	26.76

F

F

GENERAL TOLERANCES (UNLESS SPECIFIED)		ZHE JIANG DELI CONNECTORS CO., LTD			
.X: ± 0.25	X°: $\pm 3.0^\circ$	PRODUCT NAME: DL39602(VH)-RS		TITLE: 3.96 mm pitch WTW Connector Housing	
.XX: ± 0.15	.X°: $\pm 2.0^\circ$	DR: Chen Quan Long	DATE: 22.10.10	PART NO:	
.XXX: ± 0.01	.XX°: $\pm 1.0^\circ$	CHKD: Wu Hui	DATE: 22.10.10	SCALE: N/A	PAGE: 1/1
DRAWING NO:		APPD: Ren An De	DATE: 22.10.10	UNITS: mm	REV.: A

1

2

3

4

5

6

7

8

REV.	REVISION DESCRIPTION	DATE	APPD

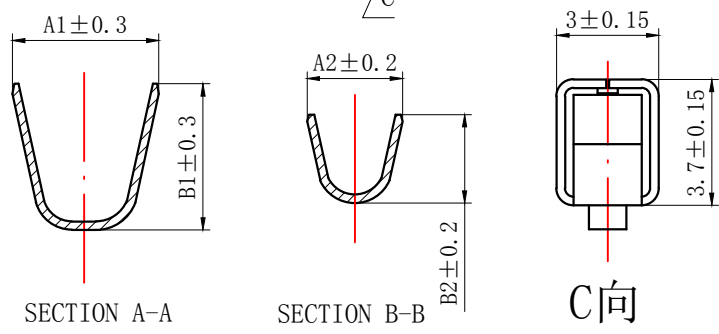
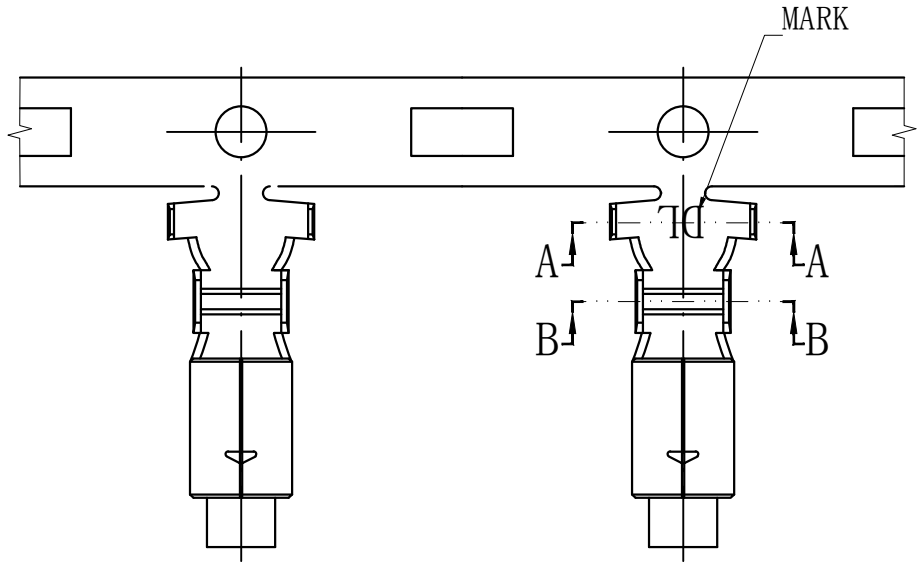

NOTES

Used in DL39602-Y Series Housing.
 Accepts AWG #24~16 Wire Range.
 Insulation O.D. = 1.2~3.0 mm.
 Material : Phosphor Bronze .
 Finish: Tin plated.
 Qty/Reel: 3,500 PCS.
 Thickness: 0.25 mm.

Product name	Dimension mm				适用线规 AWG#
	A1	B1	A2	B2	
VH-T-04	2.3	2.3	2.0	1.8	24-22
VH-T-03	4.3	4.3	2.8	2.6	20-16
VH-T-02	4.0	4.1	2.8	2.3	22-18

GENERAL TOLERANCES (UNLESS SPECIFIED)		ZHE JIANG DELI CONNECTORS CO., LTD	
.X: ± 0.25	X°: ± 3.0°	PRODUCT NAME: DL39602 (VH)-T	TITLE: 3.96mm Pitch Crimp Terminal
.XX: ± 0.15	.X°: ± 2.0°	DR: Yuan Jun Rong	DATE: 21.3.3
.XXX: ± 0.01	.XX°: ± 1.0°	CHKD: Liu Bing	DATE: 21.3.3
FINISH:		APPD: Liu Bing	DATE: 21.3.3
DRAWING NO:			

PART NO:	
SCALE: N/A	PAGE: 1/1
UNITS: mm	REV.: A

REV.	REVISION DESCRIPTION	DATE	APPD

NOTES

Used in DL39602-R Series Housing.
 Accepts AWG #22~16 Wire Range.
 Insulation O.D. = 1.7~3.0 mm.
 Material : Phosphor Bronze .
 Finish: Tin plated 2um Min.
 Thickness: 0.25 mm.

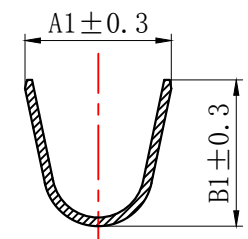

SECTION A-A

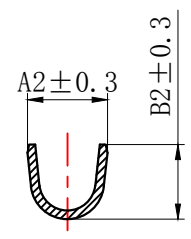

SECTION B-B

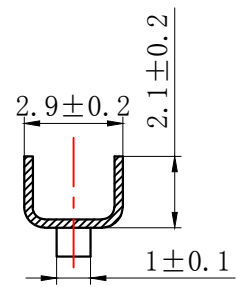

SECTION C-C

TYPE	Dimension mm				Applicable wires
	A1	B1	A2	B2	AWG#
VH-RT-G	4.3	4.3	2.8	2.6	20-16
VH-RT	4.3	4.3	2.35	2.2	22-18

GENERAL TOLERANCES (UNLESS SPECIFIED)		ZHE JIANG DELI CONNECTORS CO., LTD	
.X: ± 0.25	X°: ± 3.0°	PRODUCT NAME: DL39602 (VH)-RT	TITLE: 3.96 mm Pitch Wire To Wire Crimp Terminal
.XX: ± 0.15	.X°: ± 2.0°	DR: Chen Quan Long	DATE: 21.10.10
.XXX: ± 0.01	.XX°: ± 1.0°	DATE: 21.10.10	PART NO:
FINISH:		CHKD: Wu Hui	DATE: 21.10.10
DRAWING NO:		APPD: Ren An De	DATE: 21.10.10
		SCALE: N/A	PAGE: 1/1
		UNITS: mm	REV.: A

X-ON Electronics

Largest Supplier of Electrical and Electronic Components

Click to view similar products for [Headers & Wire Housings](#) category:

Click to view products by [DLL](#) manufacturer:

Other Similar products are found below :

[0015917161](#) [0022155065](#) [57102-F02-18ULF](#) [58102-G61-06LF](#) [582553-1](#) [01.001.5753.1](#) [0050291907](#) [02.125.8002.8](#) [609-3404](#) [61062-3](#)
[CSU011177004](#) [622-0430](#) [622-3653LF](#) [63453-116](#) [636-1030](#) [636-1427](#) [636-3427](#) [636-4007](#) [641938-9](#) [65495-038](#) [65692-001LF](#) [65781-018](#)
[65781-047](#) [65817-010LF](#) [65817-015LF](#) [67095-007LF](#) [67601157](#) [68631-112](#) [68645-018](#) [699319-000](#) [70.362.1628.0](#) [70-4210](#) [70-4226B](#) [70-](#)
[4853B](#) [71.350.2428.0](#) [733-134](#) [733-162](#) [MHR-64-VUAL](#) [80.063.4001.1](#) [800-90-001-10-001000](#) [801-43-002-10-013000](#) [801-43-006-10-](#)
[002000](#) [803-43-024-10-001000](#) [803-93-012-10-001000](#) [8-1437020-4](#) [819-22-004-30-001101](#) [820-22-006-30-001101](#) [820-22-008-30-001101](#)
[821-22-002-10-001101](#) [821-22-003-10-002101](#)