

技术特性/Specifications:

额定电压 Rated voltage: 600V AC, DC
额定电流 Rated current: 20A AC, DC
接触电阻 Contact resistance: 20mΩ max
绝缘电阻 Insulation resistance: 1000MΩ min
耐压 Withstand voltage: 2000V AC/minute
环境温度 Ambient temperature: -40°C~+105°C
适用线规 Wire range: AWG#22~#12

VL-2A

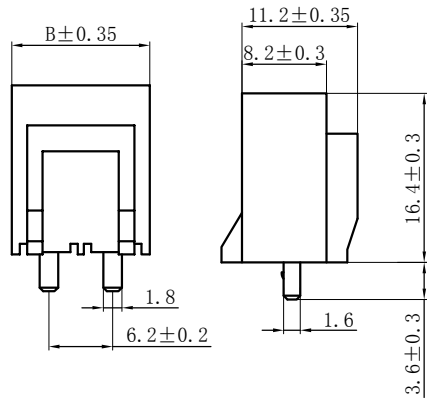

VL-4AM

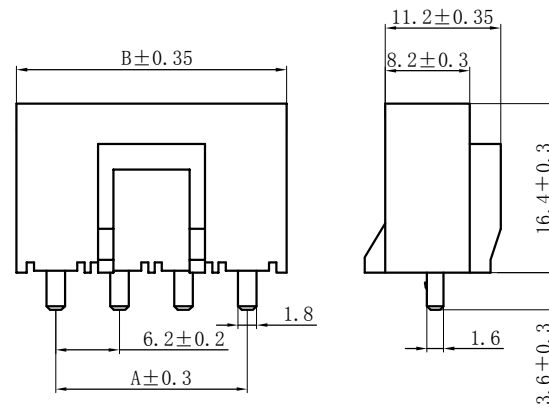

VL-3A

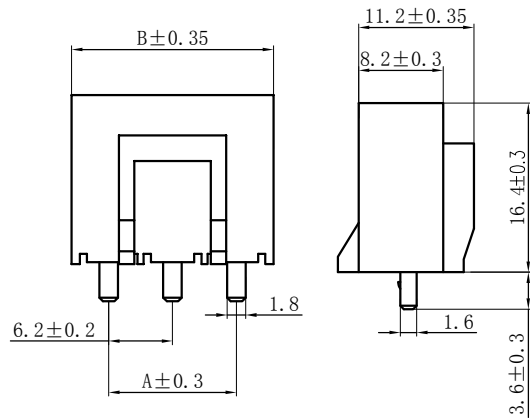

REV.	REVISION DESCRIPTION	DATE	APPD

NOTES

Available in 02-04 Circuits.
 Mates with DL62002-Y Series Housing.
 Material : Nylon UL94V-0(2).
 Green Material RoHS Compliant.

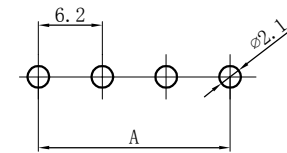

PCB LAYOUT

Circuits	Dimension mm	
	A	B
1X2	/	13.40
1X3	12.40	19.60
1X4	18.60	26.20

GENERAL TOLERANCES (UNLESS SPECIFIED)		ZHE JIANG DELI CONNECTORS CO., LTD	
.X: ± 0.35	X° : ± 3.0°	PRODUCT NAME: DL62002 (VL)-A	TITLE: 6.2 mm Pitch Wire To Board Wafer
.XX: ± 0.25	.X° : ± 2.0°	DR: Chen Quan Long	DATE:21/08/01
.XX: ± 0.01	.XX° : ± 1.0°	DATE:21/08/01	SCALE: N/A
FINISH:		CHKD: Wu Hui	DATE:21/08/01
DRAWING NO:		APPD:Ren An De	DATE:21/08/01
			PART NO:
			SCALE: N/A
			PAGE: 1/2
			UNITS: mm
			REV.: A

VL-4A

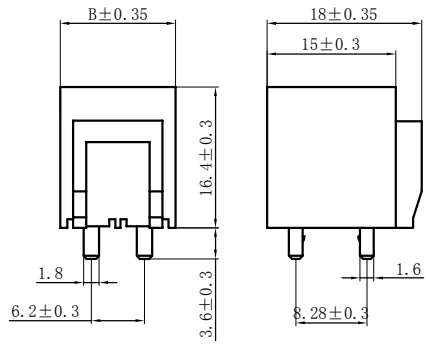

VL-6A

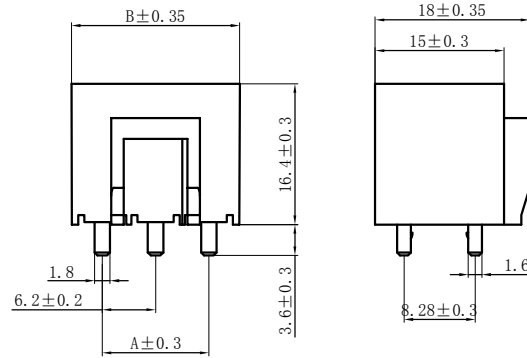

VL-8A

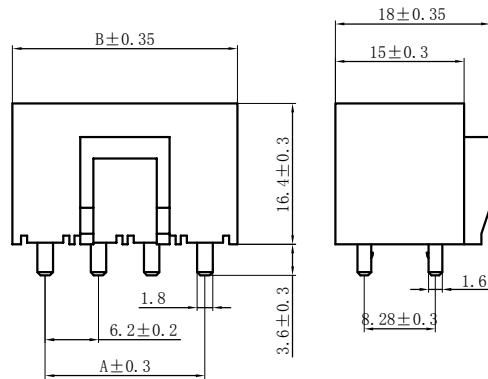

VL-12A

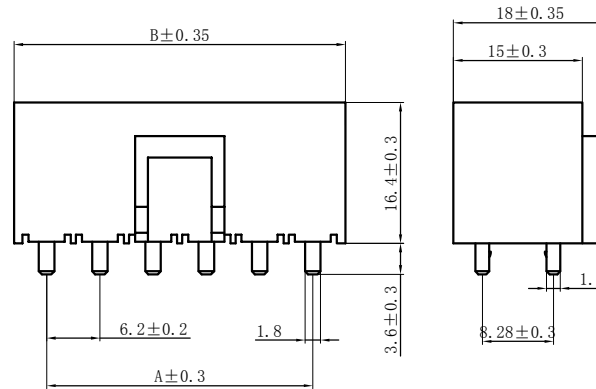

REV.	REVISION DESCRIPTION	DATE	APPD

NOTES

Available in 04-12 Circuits.

Mates with DL62002-Y Series Housing.

Material : Nylon UL94V-0(2).

Green Material RoHS Compliant.

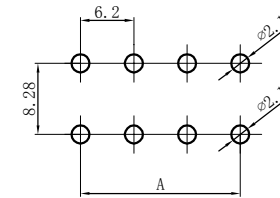

PCB LAYOUT

Circuits	Dimension mm	
	A	B
2X2	/	13.40
2X3	12.40	19.60
2X4	18.60	26.20
2X6	31.00	38.60

GENERAL TOLERANCES
(UNLESS SPECIFIED)

.X: ± 0.35	X° : ± 3.0°
.XX: ± 0.25	.X° : ± 2.0°
.XX: ± 0.01	.XX° : ± 1.0°
FINISH:	
DRAWING NO:	

ZHE JIANG DELI CONNECTORS CO., LTD

PRODUCT NAME: DL62002 (VL)-A	TITLE: 6.2 mm Pitch Wire To Board Wafer
DR: Chen Quan Long	DATE:21/08/01
CHKD: Wu Hui	DATE:21/08/01
APPD:Ren An De	DATE:21/08/01
PART NO:	SCALE: N/A
	PAGE: 2/2
	UNITS: mm
	REV.: A

VL-1Y

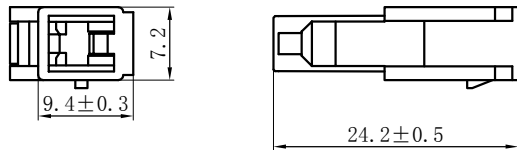

VL-3Y

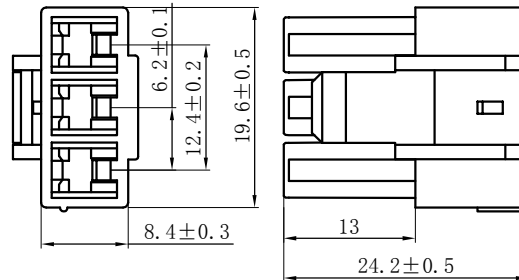

VL-2Y

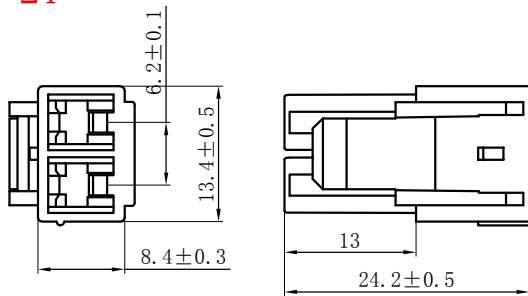

NOTES

Available in 01.02.03.04 Circuits.
 Mates with DL62002 Series Housing.
 Material : Nylon UL94V-0(2).
 Accepts DL62002-T Crimp Terminal.
 Green Material RoHS Compliant.

VL-4YM

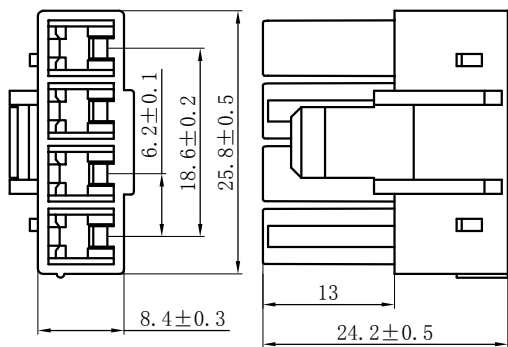

VL-4Y

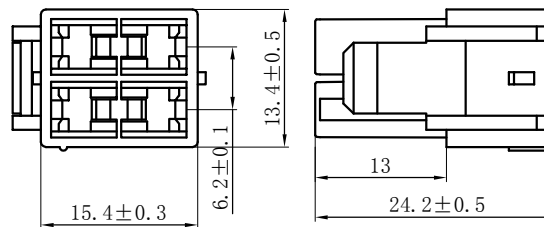

REV.	REVISION DESCRIPTION	DATE	APPD

GENERAL TOLERANCES (UNLESS SPECIFIED)		ZHE JIANG DELI CONNECTORS CO., LTD	
.X: ± 0.25	X° : ± 3.0°	PRODUCT NAME: DL62002 (VL)-Y	TITLE: 6.2mm Pitch Connector
.XX: ± 0.15	.X° : ± 2.0°	DR: Chen Quan Long	DATE:21/01/02
.XXX: ± 0.01	.XX° : ± 1.0°	DATE:21/01/02	PART NO:
FINISH:		CHKD:Wu Hui	DATE:21/01/02
DRAWING NO:	APPD:Ren An De	DATE:21/01/02	SCALE: N/A
			PAGE: 1/2
			UNITS: mm
			REV.: A

VL-6Y

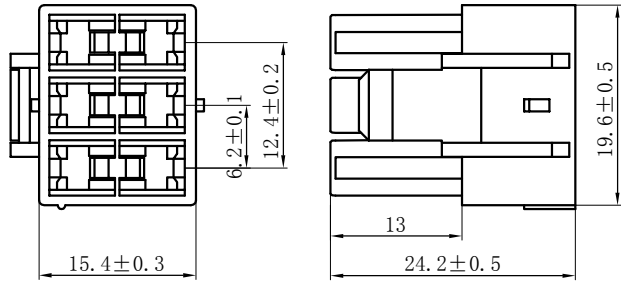

VL-8Y

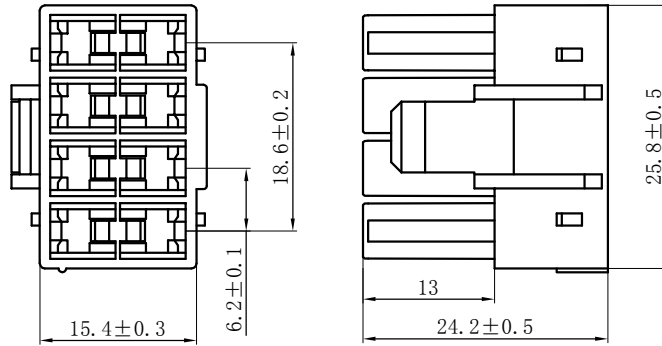

VL-12Y

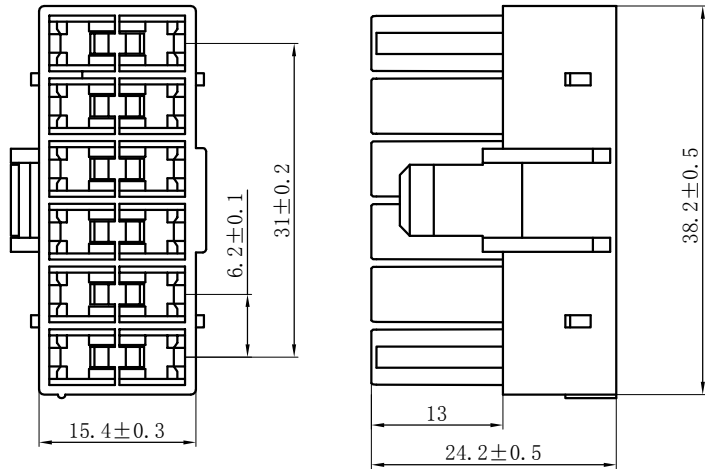

REV.	REVISION DESCRIPTION	DATE	APPD

NOTES

Available in 06.08.12 Circuits.
 Mates with DL62002 Series Housing.
 Material : Nylon UL94V-0(2).
 Accepts DL62002-T Crimp Terminal.
 Green Material RoHS Compliant.

GENERAL TOLERANCES (UNLESS SPECIFIED)		ZHE JIANG DELI CONNECTORS CO., LTD	
.X: ± 0.25	X°: ± 3.0°	PRODUCT NAME: DL62002 (VL)-Y	TITLE: 6.2mm Pitch Connector
.XX: ± 0.15	.X°: ± 2.0°	DR: Chen Quan Long	DATE:21/01/02
.XXX: ± 0.01	.XX°: ± 1.0°	DATE:21/01/02	PART NO:
FINISH:		CHKD:Wu Hui	DATE:21/01/02
DRAWING NO:	APPD:Ren An De	DATE:21/01/02	SCALE: N/A
			PAGE: 2/2
			UNITS: mm
			REV.: A

VL-2VY

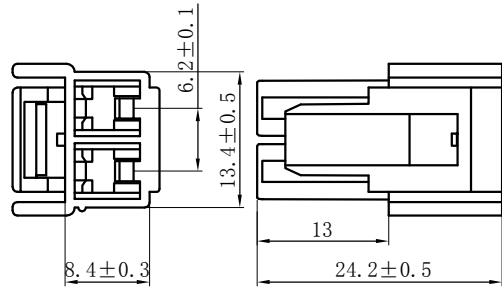

VL-3VY

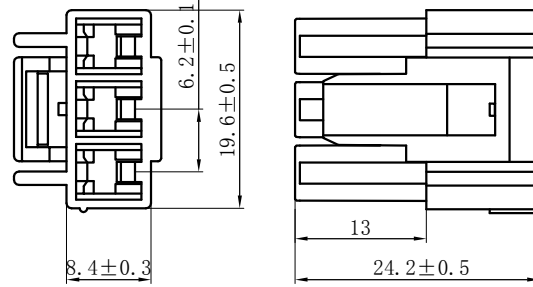

VL-4VYM

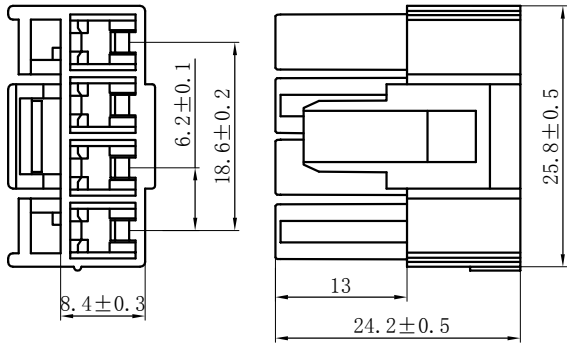

VL-4VY

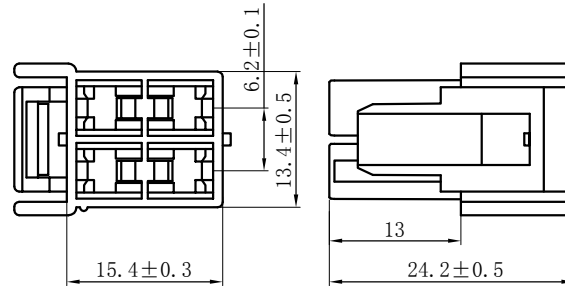

REV.	REVISION DESCRIPTION	DATE	APPD

NOTES

Available in 02.03.04 Circuits.

Mates with DL62002 Series Housing.

Material : Nylon UL94V-0(2).

Accepts DL62002-T Crimp Terminal.

Green Material RoHS Compliant.

GENERAL TOLERANCES
(UNLESS SPECIFIED)

.X: ± 0.25 X° : ± 3.0°

.XX: ± 0.15 .X° : ± 2.0°

.XXX: ± 0.01 .XX° : ± 1.0°

FINISH:

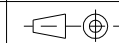

DRAWING NO:

ZHE JIANG DELI CONNECTORS CO., LTD

PRODUCT NAME:
DL62002 (VL)-VY

TITLE:
6.2mm Pitch Connector

DR: Chen Quan Long DATE:21/01/02

PART NO:

CHKD:Wu Hui DATE:21/01/02

SCALE: N/A PAGE: 1/2

APPD:Ren An De DATE:21/01/02

UNITS: mm REV.: A

VL-6VY

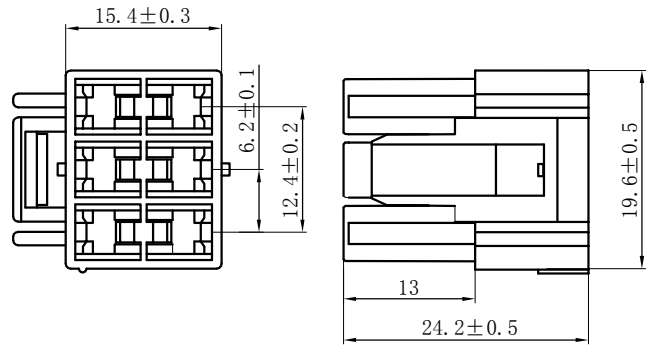

VL-8VY

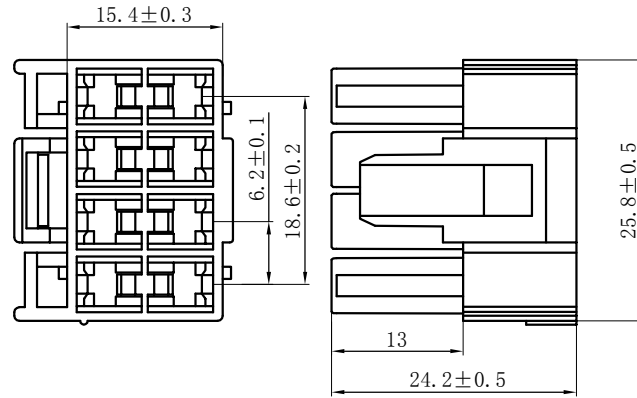

VL-12VY

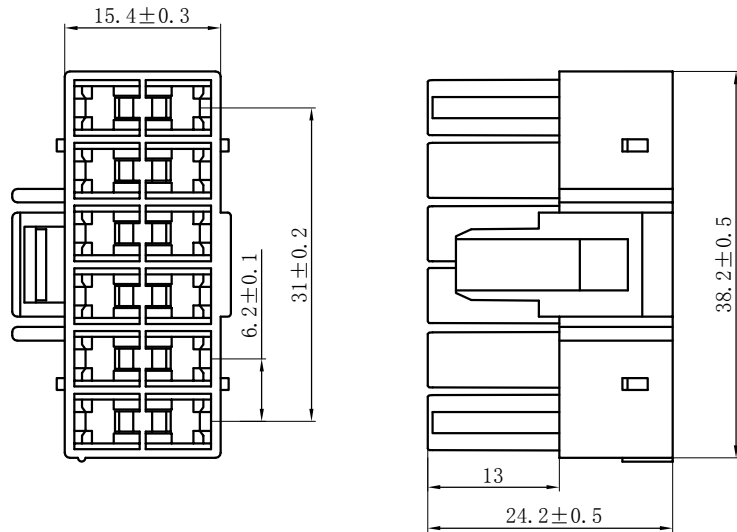

REV.	REVISION DESCRIPTION	DATE	APPD

NOTES

- Available in 06.08.12 Circuits.
- Mates with DL62002 Series Housing.
- Material : Nylon UL94V-0(2).
- Accepts DL62002-T Crimp Terminal.
- Green Material RoHS Compliant.

GENERAL TOLERANCES (UNLESS SPECIFIED)		ZHE JIANG DELI CONNECTORS CO., LTD	
.X: ± 0.25	X°: $\pm 3.0^\circ$	PRODUCT NAME:	TITLE:
.XX: ± 0.15	.X°: $\pm 2.0^\circ$	DL62002 (VL)-VY	6.2mm Pitch Connector
.XXX: ± 0.01	.XX°: $\pm 1.0^\circ$	DR: Chen Quan Long	DATE:21/01/02
FINISH:		CHKD:Wu Hui	DATE:21/01/02
DRAWING NO:		APPD:Ren An De	DATE:21/01/02
			SCALE: N/A
			PAGE: 2/2
			UNITS: mm
			REV.: A

VL-1R

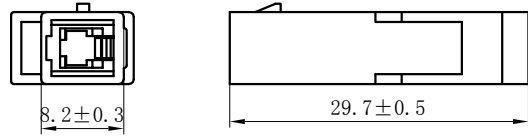

VL-3R

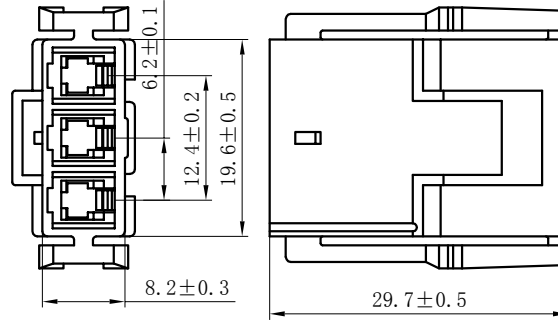

VL-2R

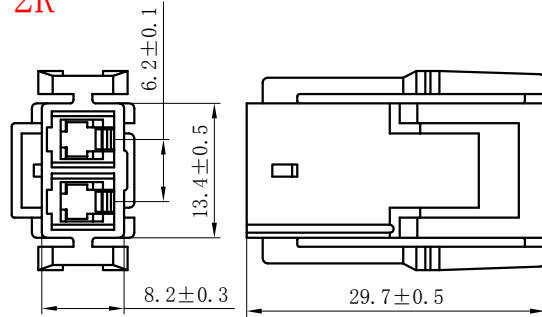

VL-4RM

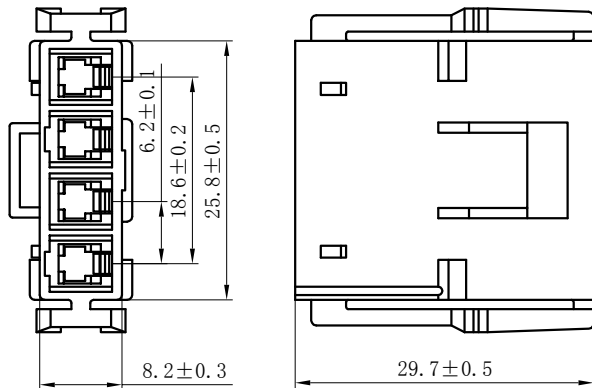

REV.	REVISION DESCRIPTION	DATE	APPD

NOTES

Available in 01.02.03.04 Circuits.
 Mates with DL62002-Y Series Housing.
 Material : Nylon UL94V-0(2).
 Accepts DL62002-RT Crimp Terminal.
 Green Material RoHS Compliant.

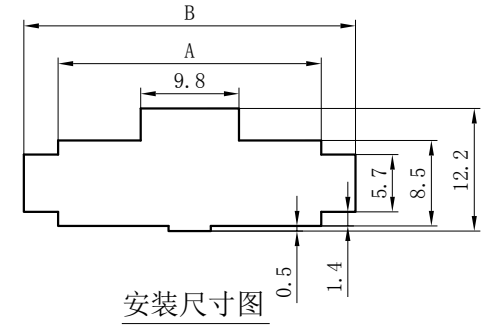

Circuits	Product name	Dimensino (mm)	
		A	B
1X2	VL-2R	13.80	20.60
1X3	VL-3R	20.00	26.80
1X4	VL-4RM	26.20	33.00

GENERAL TOLERANCES (UNLESS SPECIFIED)		ZHE JIANG DELI CONNECTORS CO., LTD	
.X: ± 0.35	X°: ± 3.0°	PRODUCT NAME: DL62002(VL)-R	TITLE: 6.2mm Pitch Wire To Wire Receptacle Housing
.XX: ± 0.25	.X°: ± 2.0°	DR:Chen Quan Long	DATE:21/01/02
.XXX: ± 0.05	.XX°: ± 1.0°	CHKD: Wu Hui	DATE:21/01/02
FINISH:		APPD:Ren An De	DATE:21/01/02
DRAWING NO:		SCALE: N/A	PAGE: 1/2
		UNITS: mm	REV.: B

VL-12R

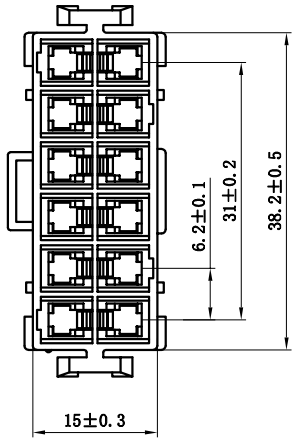

VL-8R

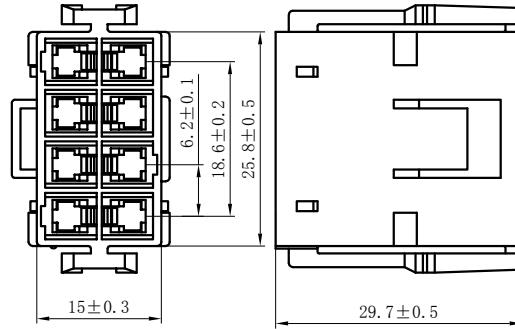

VL-6R

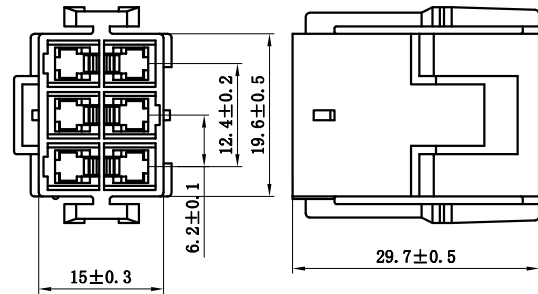

VL-4R

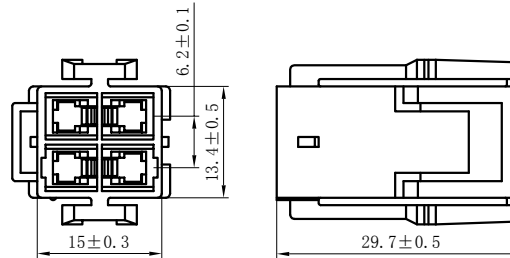

REV.	REVISION DESCRIPTION	DATE	APPD

NOTES

Available in 04.06.08.12 Circuits.
 Mates with DL62002-Y Series Housing.
 Material : Nylon UL94V-0(2).
 Accepts DL62002-RT Crimp Terminal.
 Green Material RoHS Compliant.

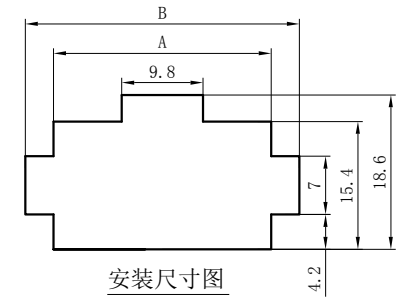

Circuits	Product name	Dimensino (mm)	
		A	B
2X2	VL-4R	13.80	20.60
2X3	VL-6R	20.00	26.80
2X4	VL-8R	26.20	33.00
2X6	VL-12R	38.90	45.40

GENERAL TOLERANCES (UNLESS SPECIFIED)		ZHE JIANG DELI CONNECTORS CO., LTD	
.X: ± 0.35	.X°: ± 3.0°	PRODUCT NAME:	TITLE: 6.2mm Pitch Wire To Wire Receptacle Housing
.XX: ± 0.25	.X°: ± 2.0°	DR:Chen Quan Long	DATE:21/01/02
.XXX: ± 0.05	.XX°: ± 1.0°	CHKD: Wu Hui	DATE:21/01/02
FINISH:		APPD:Ren An De	DATE:21/01/02
DRAWING NO:			SCALE: N/A PAGE: 2/2
			UNITS: mm REV.: B

VL-1S

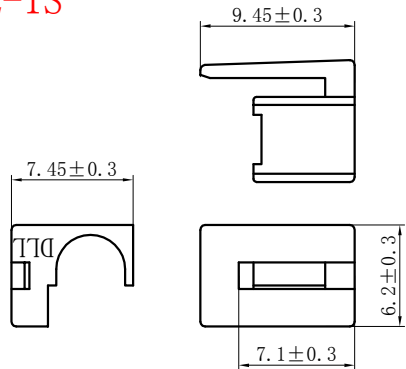

VL-4S

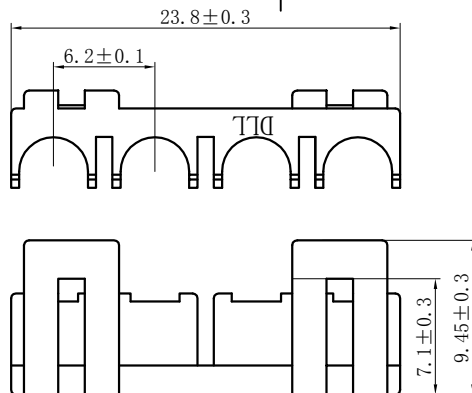

VL-2S

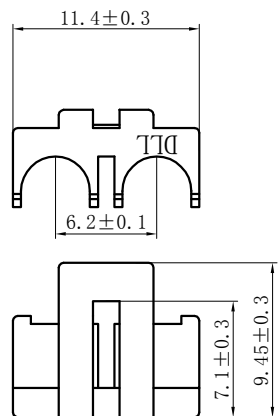

VL-6S

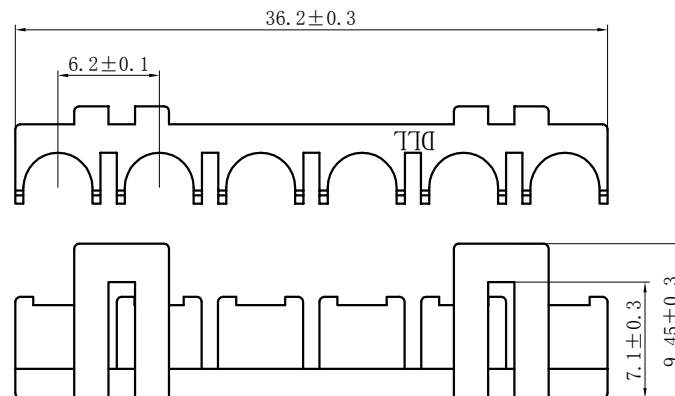

VL-3S

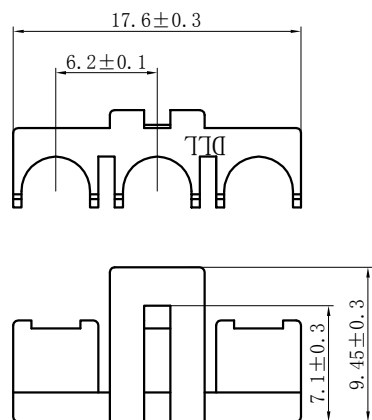

REV.	REVISION DESCRIPTION	DATE	APPD

NOTES

Available in 01 through 06 Circuits.
 Mates with DL62002-Y or DL62002-R
 Series Housing.

Material : Nylon UL94V-0(2).
 Green Material RoHS Compliant.

GENERAL TOLERANCES (UNLESS SPECIFIED)		ZHE JIANG DELI CONNECTORS CO., LTD	
.X: ± 0.35	.X° : ± 3.0°	PRODUCT NAME: DL62002 (VL)-S	TITLE: 6.2mm Pitch Wire To Wire Receptacle Housing
.XX: ± 0.25	.X° : ± 2.0°	DR:Chen Quan Long	DATE:21/01/02
.XXX: ± 0.05	.XX° : ± 1.0°	CHKD: Wu Hui	DATE:21/01/02
FINISH:		APPD: Ren An De	DATE:21/01/02
DRAWING NO:		SCALE: N/A	PAGE: 1/1
		UNITS: mm	REV.: A

REV.	REVISION DESCRIPTION	DATE	APPD

NOTES

Used in DL62002-Y Series Housing.
 Accepts AWG #22~12 Wire Range.
 Insulation O. D. =1.7~4.1mm.
 Material : Phosphor Bronze .
 Finish: Tin plated.
 Thickness: 0.25 mm.

Product name	Dimension mm				Wire range
	A1	B1	A2	B2	AWG#
VL-T-G	6.0	5.7	4.0	4.6	12
VL-T	6.0	5.7	3.6	3.5	20-14
VL-T-D	6.0	5.7	3.6	3.0	22-16

GENERAL TOLERANCES (UNLESS SPECIFIED)		ZHE JIANG DELI CONNECTORS CO., LTD	
.X: ± 0.25	.X°: ± 3.0°	PRODUCT NAME: DL62002 (VL) -T	TITLE: 6.2mm Pitch Crimp Terminal
.XX: ± 0.15	.X°: ± 2.0°	DR:Chen Quan Long	DATE:21.01.02
.XXX: ± 0.01	.XX°: ± 1.0°	CHKD:Wu Hui	DATE:21.01.02
DRAWING NO:		APPD:Ren An De	DATE:21.01.02
		SCALE: N/A	PAGE: 1/1
		UNITS: mm	REV.: A

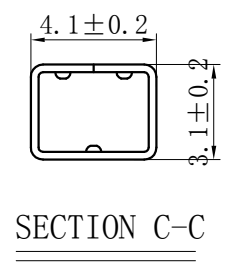
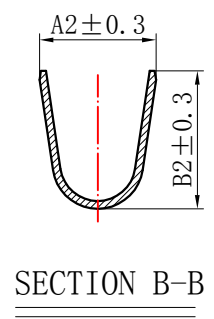
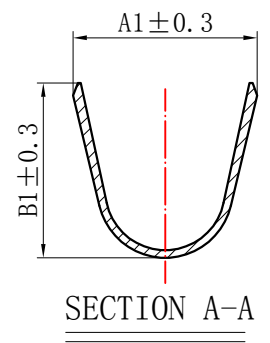
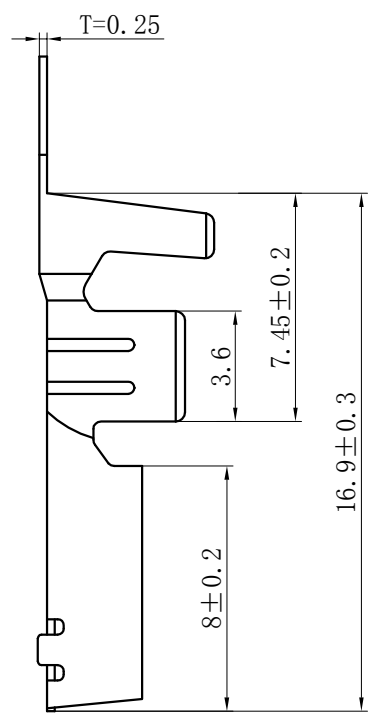
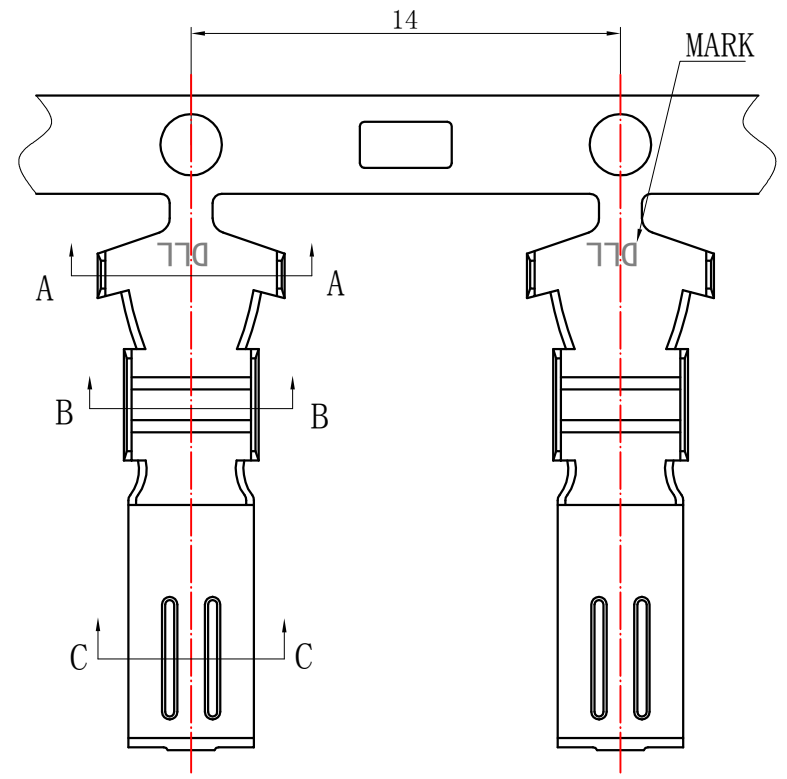

REV.	REVISION DESCRIPTION	DATE	APPD

NOTES

Used in DL62002-R Series Housing.
 Accepts AWG #22~12 Wire Range.
 Insulation O. D. =1.7~4.1mm.
 Material : Phosphor Bronze .
 Finish: Tin plated.
 Thickness: 0.25 mm.

Product name	Dimension mm				Wire range
	A1	B1	A2	B2	AWG#
VL-RT-G	5.2	5.8	3.8	4.5	12
VL-RT	5.1	5.7	3.5	3.5	20-14
VL-RT-D	5.1	5.7	3.5	3.0	22-16

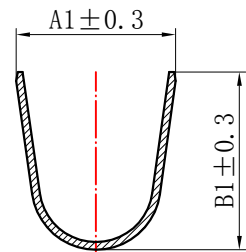
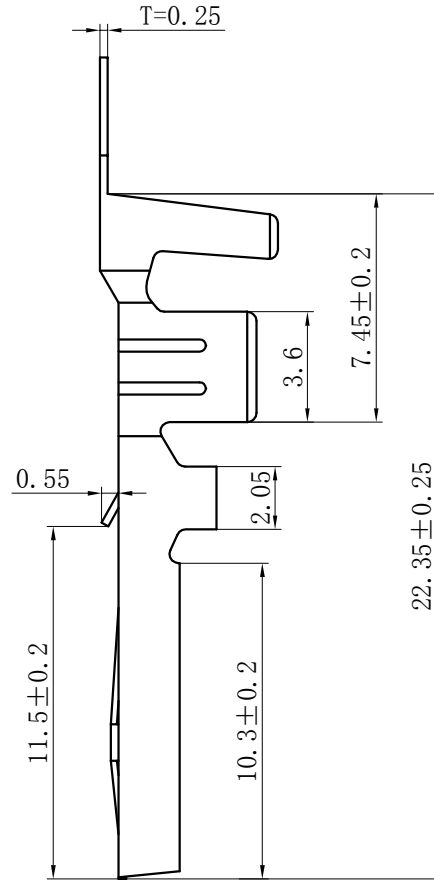
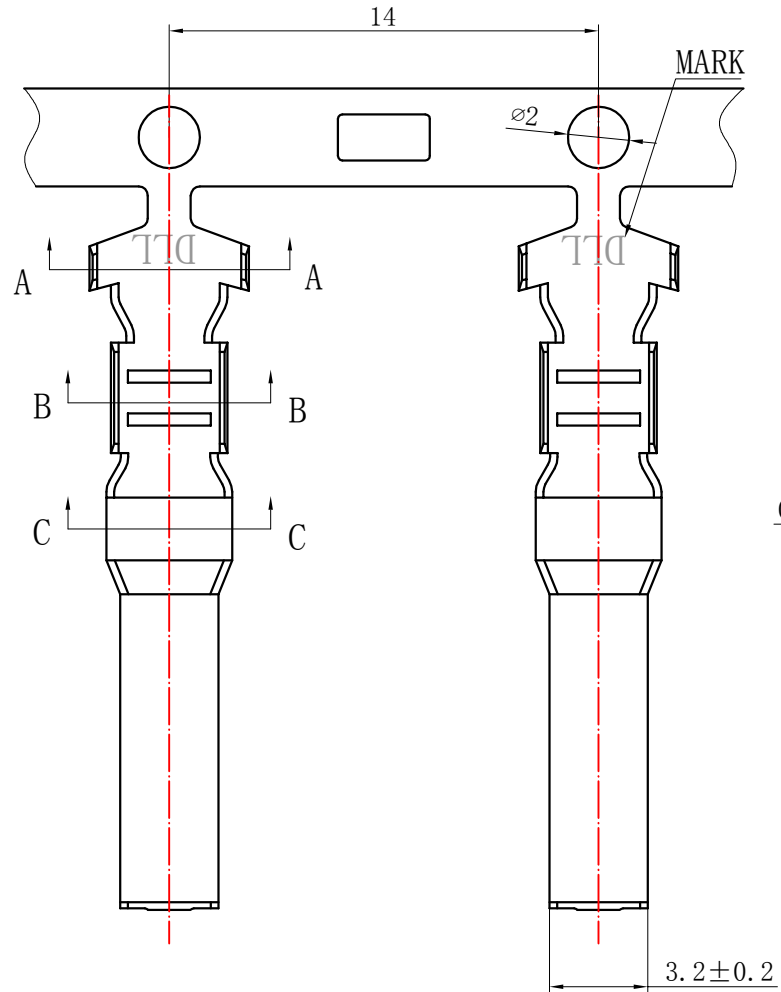

SECTION A-A

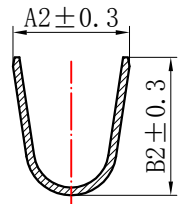

SECTION B-B

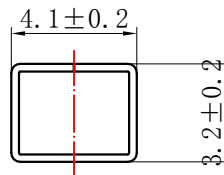

SECTION C-C

GENERAL TOLERANCES (UNLESS SPECIFIED)		ZHE JIANG DELI CONNECTORS CO., LTD	
.X: ± 0.25	X°: $\pm 3.0^\circ$	PRODUCT NAME:	TITLE: 6.2mm Pitch Wire To Wire Crimp Terminal
.XX: ± 0.15	.X°: $\pm 2.0^\circ$	DL62002 (VL) -RT	PART NO:
.XXX: ± 0.01	.XX°: $\pm 1.0^\circ$	DR:Chen Quan Long	DATE:21.01.02
FINISH:		CHKD:Wu Hui	DATE:21.01.02
DRAWING NO:		APPD:Ren An De	DATE:21.01.02
		SCALE: N/A	PAGE: 1/1
		UNITS: mm	REV.: A

X-ON Electronics

Largest Supplier of Electrical and Electronic Components

Click to view similar products for [Headers & Wire Housings](#) category:

Click to view products by [DLL](#) manufacturer:

Other Similar products are found below :

[0015917161](#) [0022155065](#) [57102-F02-18ULF](#) [58102-G61-06LF](#) [582553-1](#) [01.001.5753.1](#) [0050291907](#) [02.125.8002.8](#) [609-3404](#) [61062-3](#)
[CSU011177004](#) [622-0430](#) [622-3653LF](#) [63453-116](#) [636-1030](#) [636-1427](#) [636-3427](#) [636-4007](#) [641938-9](#) [65495-038](#) [65692-001LF](#) [65781-018](#)
[65781-047](#) [65817-010LF](#) [65817-015LF](#) [67095-007LF](#) [67601157](#) [68631-112](#) [68645-018](#) [699319-000](#) [70.362.1628.0](#) [70-4210](#) [70-4226B](#) [70-](#)
[4853B](#) [71.350.2428.0](#) [733-134](#) [733-162](#) [MHR-64-VUAL](#) [80.063.4001.1](#) [800-90-001-10-001000](#) [801-43-002-10-013000](#) [801-43-006-10-](#)
[002000](#) [803-43-024-10-001000](#) [803-93-012-10-001000](#) [8-1437020-4](#) [819-22-004-30-001101](#) [820-22-006-30-001101](#) [820-22-008-30-001101](#)
[821-22-002-10-001101](#) [821-22-003-10-002101](#)