

技术特性/Specifications:

额定电压 Rated voltage: 250V AC, DC
额定电流 Rated current: 3A AC, DC
接触电阻 Contact resistance: 20m Ω max
绝缘电阻 Insulation resistance: 1000M Ω min
耐压 Withstand voltage: 1000V AC/minute
环境温度 Ambient temperature: -40 $^{\circ}$ C~+105 $^{\circ}$ C
适用线规 Wire range: AWG#28~#20

| | | | | |
|------|----------|-------------|------|------|
| REV. | REVISION | DESCRIPTION | DATE | APPD |
| | | | | |

NORES:

1. Rated voltage: 250V AC/DC
2. Rated current: 3A AC/DC
3. Contact resistance: $\leq 20 \text{ m}\Omega$
4. Insulation resistance: $\geq 1000 \text{ m}\Omega$
5. Withstand voltage: 1000V AC/minute
6. Ambient temperature: $-40^{\circ}\text{C} \sim 105^{\circ}\text{C}$
7. Materials: Nylon UL94V-0(2)
8. Matched RoHS criteria

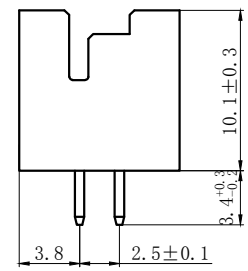
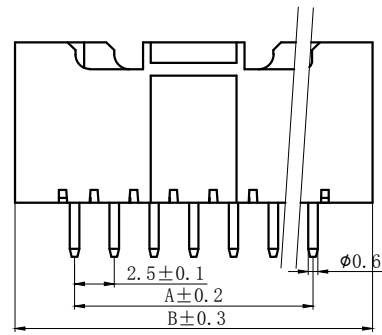
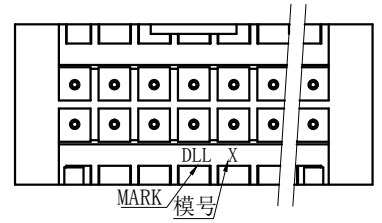

Circuit No.1
2x2~2x8PIN
C±0.2

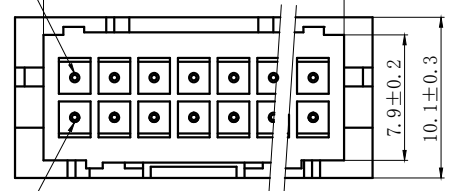

Circuit No.2

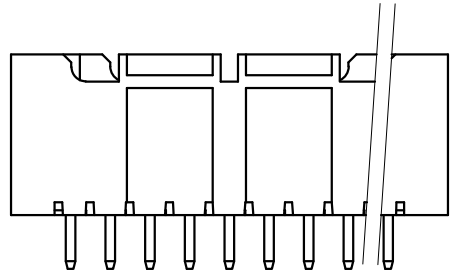
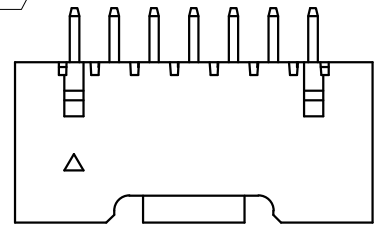

2x9PIN以上

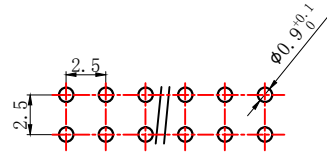

PCB LAYOUT

| Circuits | Product name | Dimensino (mm) | | | Circuits | Product name | Dimensino (mm) | | |
|----------|--------------|----------------|------|------|----------|--------------|----------------|------|------|
| | | A | B | C | | | A | B | C |
| 2x2 | XAD-4A | 2.5 | 10.0 | 6.4 | 2x10 | XAD-20A | 22.5 | 30.0 | 26.4 |
| 2x3 | XAD-6A | 5.0 | 12.5 | 8.9 | 2x11 | XAD-22A | 25.0 | 32.5 | 28.9 |
| 2x4 | XAD-8A | 7.5 | 15.0 | 11.4 | 2x12 | XAD-24A | 27.5 | 35.0 | 31.4 |
| 2x5 | XAD-10A | 10.0 | 17.5 | 13.9 | 2x13 | XAD-26A | 30.0 | 37.5 | 33.9 |
| 2x6 | XAD-12A | 12.5 | 20.0 | 16.4 | 2x14 | XAD-28A | 32.5 | 40.0 | 36.4 |
| 2x7 | XAD-14A | 15.0 | 22.5 | 18.9 | 2x15 | XAD-30A | 35.0 | 42.5 | 38.9 |
| 2x8 | XAD-16A | 17.5 | 25.0 | 21.4 | ~ | ~ | ~ | ~ | ~ |
| 2x9 | XAD-18A | 20.0 | 27.5 | 23.9 | 2x20 | XAD-40A | 47.5 | 55.0 | 51.4 |

| | | | | | |
|---------------------------------------|--------------|------------------------------------|--|--|--|
| GENERAL TOLERANCES (UNLESS SPECIFIED) | | ZHE JIANG DELI CONNECTORS CO., LTD | | | |
| .X: ± 0.25 | X°: ± 3.0° | PRODUCT NAME: DL25034 (XAD)-A | | TITLE: 2.50 mm Pitch Wire To Board Wafer | |
| .XX: ± 0.15 | .X°: ± 2.0° | DR: Chen Quan Long | | DATE:21/08/01 | |
| .XXX: ± 0.01 | .XX°: ± 1.0° | CHKD: Wu Hui | | DATE:21/08/01 | |
| FINISH: | | APPD: Ren An De | | DATE:21/08/01 | |
| DRAWING NO: | | UNITS: mm | | PAGE: 1/1 | |
| | | REV.: A | | | |

| | | | | | |
|------|---|----------------------|---|------|------|
| REV. | 7 | REVISION DESCRIPTION | 8 | DATE | APPD |
| | | | | | |

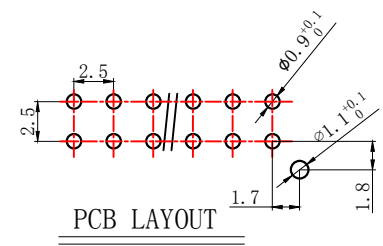
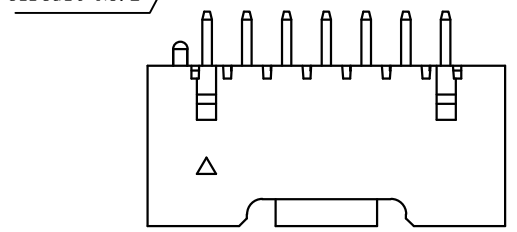
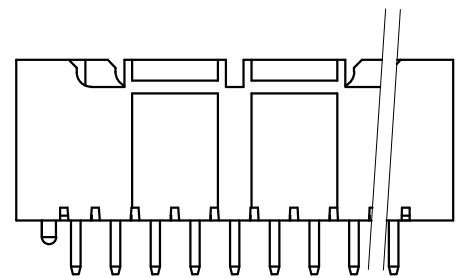
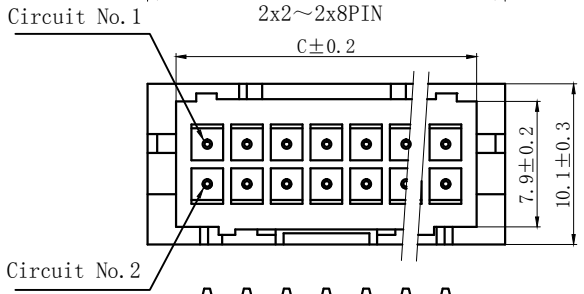
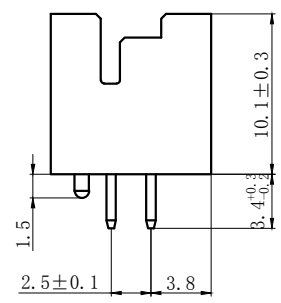
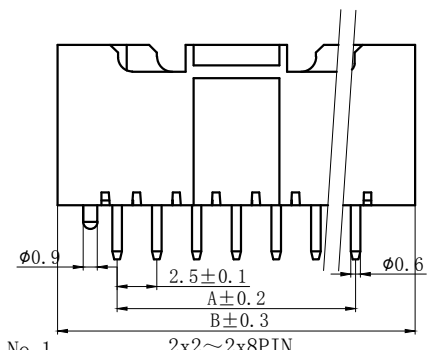
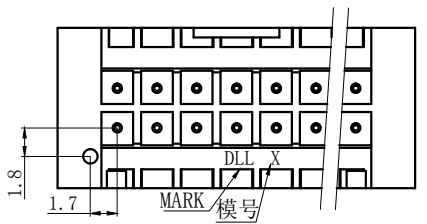

NORES:

1. Rated voltage: 250V AC/DC
2. Rated current: 3A AC/DC
3. Contact resistance: $\leq 20 \text{ m}\Omega$
4. Insulation resistance: $\geq 1000 \text{ m}\Omega$
5. Withstand voltage: 1000V AC/minute
6. Ambient temperature: $-40^{\circ}\text{C} \sim 105^{\circ}\text{C}$
7. Materials: Nylon UL94V-0 (2)
8. Matched RoHS criteria

| Circuits | Product name | Dimensino(mm) | | | Circuits | Product name | Dimensino(mm) | | |
|----------|--------------|---------------|------|------|----------|--------------|---------------|------|------|
| | | A | B | C | | | A | B | C |
| 2x2 | XAD-4AS | 2.5 | 10.0 | 6.4 | 2x10 | XAD-20AS | 22.5 | 30.0 | 26.4 |
| 2x3 | XAD-6AS | 5.0 | 12.5 | 8.9 | 2x11 | XAD-22AS | 25.0 | 32.5 | 28.9 |
| 2x4 | XAD-8AS | 7.5 | 15.0 | 11.4 | 2x12 | XAD-24AS | 27.5 | 35.0 | 31.4 |
| 2x5 | XAD-10AS | 10.0 | 17.5 | 13.9 | 2x13 | XAD-26AS | 30.0 | 37.5 | 33.9 |
| 2x6 | XAD-12AS | 12.5 | 20.0 | 16.4 | 2x14 | XAD-28AS | 32.5 | 40.0 | 36.4 |
| 2x7 | XAD-14AS | 15.0 | 22.5 | 18.9 | 2x15 | XAD-30AS | 35.0 | 42.5 | 38.9 |
| 2x8 | XAD-16AS | 17.5 | 25.0 | 21.4 | ~ | ~ | ~ | ~ | ~ |
| 2x9 | XAD-18AS | 20.0 | 27.5 | 23.9 | 2x20 | XAD-40AS | 47.5 | 55.0 | 51.4 |

| | | | | | |
|---------------------------------------|-------------------------|------------------------------------|----------------|--|-----------|
| GENERAL TOLERANCES (UNLESS SPECIFIED) | | ZHE JIANG DELI CONNECTORS CO., LTD | | | |
| .X: ± 0.25 | X°: $\pm 3.0^{\circ}$ | PRODUCT NAME: DL25034(XAD)-AS | | TITLE: 2.50 mm Pitch Wire To Board Wafer | |
| .XX: ± 0.15 | .X°: $\pm 2.0^{\circ}$ | DR: Chen Quan Long | DATE: 21/08/01 | PART NO: | |
| .XXX: ± 0.01 | .XX°: $\pm 1.0^{\circ}$ | CHKD: Wu Hui | DATE: 21/08/01 | SCALE: N/A | PAGE: 1/1 |
| DRAWING NO: | | APPD: Ren An De | DATE: 21/08/01 | UNITS: mm | REV.: A |

| REV. | REVISION DESCRIPTION | DATE | APPD |
|------|----------------------|------|------|
| | | | |

NORES:

1. Rated voltage: 250V AC/DC
2. Rated current: 3A AC/DC
3. Contact resistance: $\leq 20 \text{ m}\Omega$
4. Insulation resistance: $\geq 1000 \text{ m}\Omega$
5. Withstand voltage: 1000V AC/minute
6. Ambient temperature: $-45^\circ\text{C} \sim 105^\circ\text{C}$
7. Materials: Nylon UL94V-0(2)
8. Matched RoHS criteria

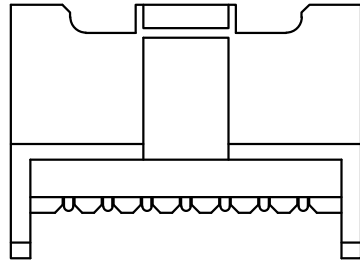

4-16PIN

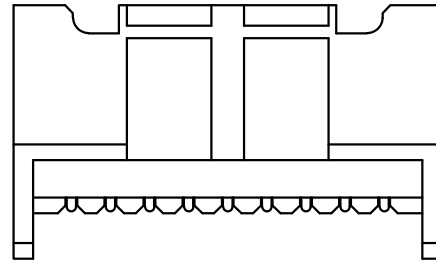

18-40PIN

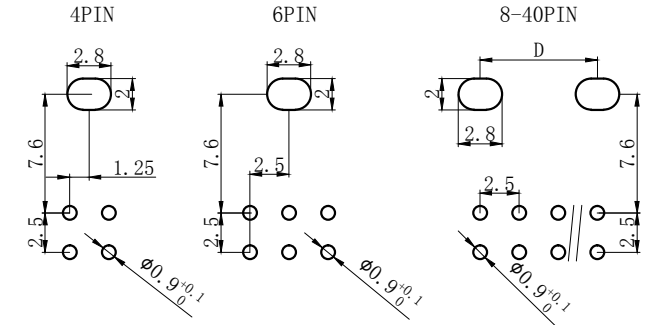
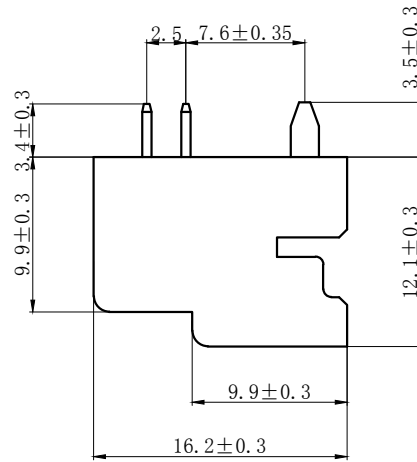
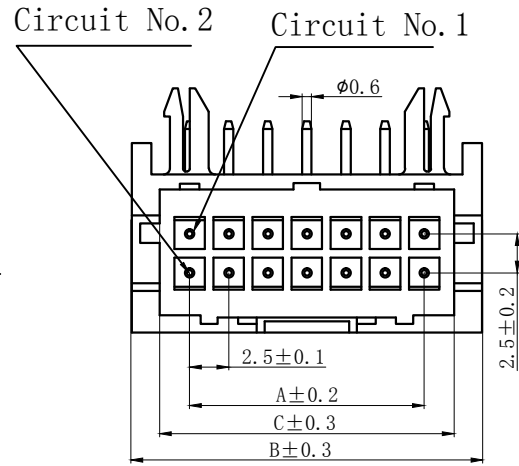

PCB LAYOUT

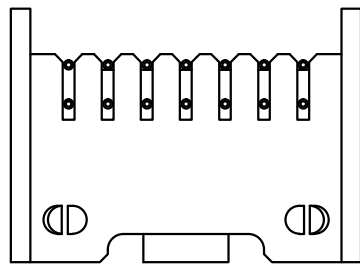

| Circuits | Product name | Dimensino (mm) | | | | Circuits | Product name | Dimensino (mm) | | | |
|----------|--------------|----------------|------|------|------|----------|--------------|----------------|------|------|------|
| | | A | B | C | D | | | A | B | C | D |
| 2x2 | XAD-4AWD-S | 2.5 | 10.0 | 6.4 | / | 2x10 | XAD-20AWD-S | 22.5 | 30.0 | 26.4 | 22.5 |
| 2x3 | XAD-6AWD-S | 5.0 | 12.5 | 8.9 | / | 2x11 | XAD-22AWD-S | 25.0 | 32.5 | 28.9 | 25.0 |
| 2x4 | XAD-8AWD-S | 7.5 | 15.0 | 11.4 | 7.5 | 2x12 | XAD-24AWD-S | 27.5 | 35.0 | 31.4 | 27.5 |
| 2x5 | XAD-10AWD-S | 10.0 | 17.5 | 13.9 | 10.0 | 2x13 | XAD-26AWD-S | 30.0 | 37.5 | 33.9 | 30.0 |
| 2x6 | XAD-12AWD-S | 12.5 | 20.0 | 16.4 | 12.5 | 2x14 | XAD-28AWD-S | 32.5 | 40.0 | 36.4 | 32.5 |
| 2x7 | XAD-14AWD-S | 15.0 | 22.5 | 18.9 | 15.0 | 2x15 | XAD-30AWD-S | 35.0 | 42.5 | 38.9 | 35.0 |
| 2x8 | XAD-16AWD-S | 17.5 | 25.0 | 21.4 | 17.5 | ~ | ~ | ~ | ~ | ~ | ~ |
| 2x9 | XAD-18AWD-S | 20.0 | 27.5 | 23.9 | 20.0 | 2x20 | XAD-40AWD-S | 47.5 | 55.0 | 51.4 | 47.5 |

GENERAL TOLERANCES (UNLESS SPECIFIED)

| | |
|--------------|--------------|
| .X: ± 0.25 | X°: ± 3.0° |
| .XX: ± 0.15 | .X°: ± 2.0° |
| .XXX: ± 0.01 | .XX°: ± 1.0° |
| FINISH: | |
| DRAWING NO: | |

ZHE JIANG DELI CONNECTORS CO., LTD

| | | | |
|--|---------------|--|-----------|
| PRODUCT NAME: DL25034(XAD)-AWD-S | | TITLE: 2.50 mm Pitch Wire To Board Wafer | |
| DR: Yuan Jun Rong | DATE:21/08/01 | PART NO: | |
| CHKD: Wu Hui | DATE:21/08/01 | SCALE: N/A | PAGE: 1/1 |
| APPD: Ren An De | DATE:21/08/01 | UNITS: mm | REV.: A |

| REV. | REVISION DESCRIPTION | DATE | APPD |
|------|----------------------|------|------|
| | | | |

NOTES

Available in 04 through 40 Circuits.

Match with DL25034 series housing

Material : Nylon UL94V-0(2).

Accepts DL25034-T Crimp Terminal.

Circuit No.2

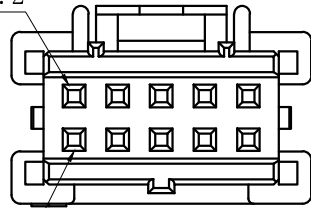

Circuit No.1

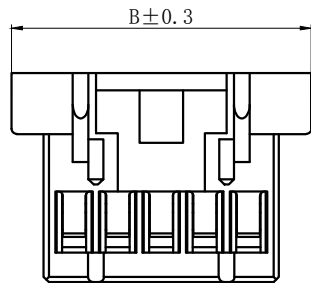

2X2-2X8PIN

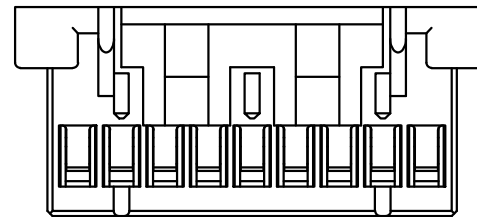
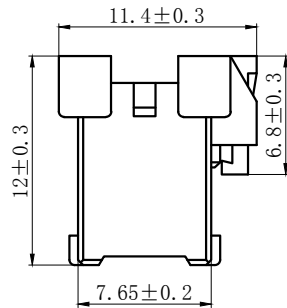
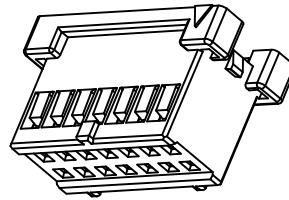

2X9-2X20PIN

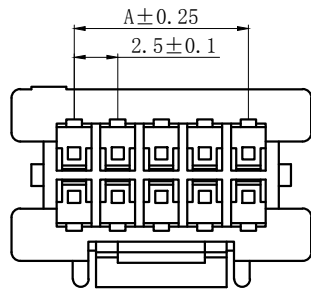

| Circuits | Product name | Dimension mm | | Circuits | Product name | Dimension mm | |
|----------|--------------|--------------|-------|----------|--------------|--------------|-------|
| | | A | B | | | A | B |
| 2X2 | XAD-4Y | 2.50 | 9.70 | 2X12 | XAD-24Y | 27.50 | 34.70 |
| 2X3 | XAD-6Y | 5.00 | 12.20 | 2X13 | XAD-26Y | 30.00 | 37.20 |
| 2X4 | XAD-8Y | 7.50 | 14.70 | 2X14 | XAD-28Y | 32.50 | 39.70 |
| 2X5 | XAD-10Y | 10.00 | 17.20 | 2X15 | XAD-30Y | 35.00 | 42.20 |
| 2X6 | XAD-12Y | 12.50 | 19.70 | 2X16 | XAD-32Y | 37.50 | 44.70 |
| 2X7 | XAD-14Y | 15.00 | 22.20 | 2X17 | XAD-34Y | 40.00 | 47.20 |
| 2X8 | XAD-16Y | 17.50 | 24.70 | 2X18 | XAD-36Y | 42.50 | 49.70 |
| 2X9 | XAD-18Y | 20.00 | 27.20 | 2X19 | XAD-38Y | 45.00 | 52.20 |
| 2X10 | XAD-20Y | 22.50 | 29.70 | 2X20 | XAD-40Y | 47.50 | 54.70 |
| 2X11 | XAD-22Y | 25.00 | 32.20 | | | | |

GENERAL TOLERANCES
(UNLESS SPECIFIED)

| | |
|--------------|---------------|
| .X: ± 0.25 | X° : ± 3.0° |
| .XX: ± 0.15 | .X° : ± 2.0° |
| .XXX: ± 0.01 | .XX° : ± 1.0° |
| FINISH: | |
| DRAWING NO: | |

ZHE JIANG DELI CONNECTORS CO., LTD

| | | | |
|----------------------------------|----------------|---------------------------------|-----------|
| PRODUCT NAME: DL25034 (XAD)-Y | | TITLE: 2.50 mm Pitch Housing | |
| DR: Chen Quan Long | DATE: 19/08/01 | PART NO: | |
| CHKD: Wu Hui | DATE: 19/08/01 | SCALE: N/A | PAGE: 1/1 |
| APPD: Ren An De | DATE: 19/08/01 | UNITS: mm | REV.: A |

| REV. | REVISION DESCRIPTION | DATE | APPD |
|------|----------------------|------|------|
| | | | |

NORES:

1. Rated voltage: 250V AC/DC
2. Rated current: 3A AC/DC
3. Contact resistance: $\leq 10 \text{ m}\Omega$
4. Insulation resistance: $\geq 500 \text{ m}\Omega$
5. Withstand voltage: 1500V AC/minute
6. Ambient temperature: $-40^\circ\text{C} \sim 105^\circ\text{C}$
7. Materials: Nylon UL94V-0 (2)
8. Matched RoHS criteria

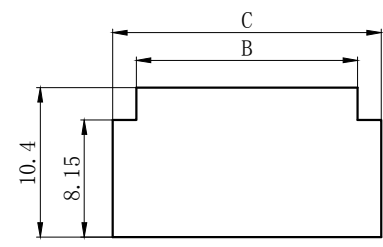
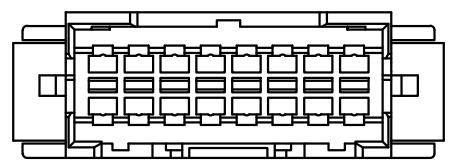
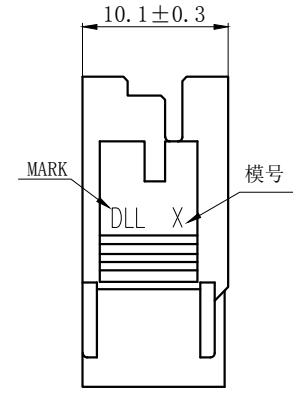
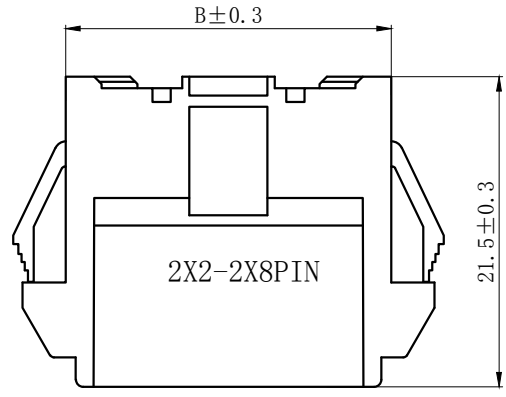
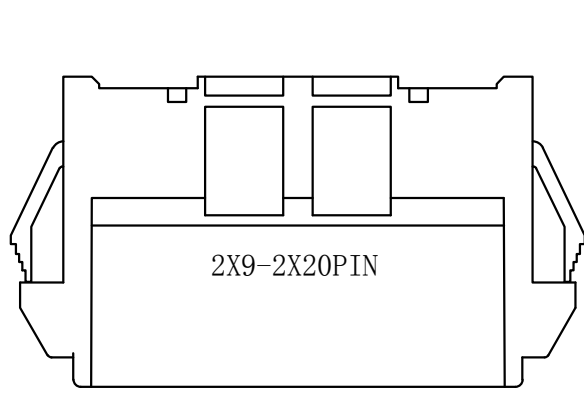
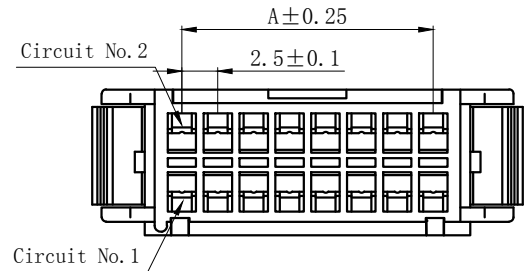

| Circuits | Product name | Dimension mm | | | Circuits | Product name | Dimension mm | | |
|----------|--------------|--------------|-------|-------|----------|--------------|--------------|-------|-------|
| | | A | B | C | | | A | B | C |
| 2X2 | XAD-4R | 2.50 | 7.90 | 11.20 | 2X12 | XAD-24R | 27.50 | 32.90 | 36.20 |
| 2X3 | XAD-6R | 5.00 | 10.40 | 13.70 | 2X13 | XAD-26R | 30.00 | 35.40 | 38.70 |
| 2X4 | XAD-8R | 7.50 | 12.90 | 16.20 | 2X14 | XAD-28R | 32.50 | 37.90 | 41.20 |
| 2X5 | XAD-10R | 10.00 | 15.40 | 18.70 | 2X15 | XAD-30R | 35.00 | 40.40 | 43.70 |
| 2X6 | XAD-12R | 12.50 | 17.90 | 21.20 | 2X16 | XAD-32R | 37.50 | 42.90 | 46.20 |
| 2X7 | XAD-14R | 15.00 | 20.40 | 23.70 | 2X17 | XAD-34R | 40.00 | 45.40 | 48.70 |
| 2X8 | XAD-16R | 17.50 | 22.90 | 26.20 | 2X18 | XAD-36R | 42.50 | 47.90 | 51.20 |
| 2X9 | XAD-18R | 20.00 | 25.40 | 28.70 | 2X19 | XAD-38R | 45.00 | 50.40 | 53.70 |
| 2X10 | XAD-20R | 22.50 | 27.90 | 31.20 | 2X20 | XAD-40R | 47.50 | 52.90 | 56.20 |
| 2X11 | XAD-22R | 25.00 | 30.40 | 33.70 | | | | | |

| | | | |
|---------------------------------------|--------------|------------------------------------|---|
| GENERAL TOLERANCES (UNLESS SPECIFIED) | | ZHE JIANG DELI CONNECTORS CO., LTD | |
| .X: ± 0.25 | X°: ± 3.0° | PRODUCT NAME: DL25034 (XAD)-R | TITLE: 2.50 mm Pitch Wire To Wire Housing |
| .XX: ± 0.15 | .X°: ± 2.0° | DR: Yuan Jun Rong | DATE: 21/12/30 |
| .XXX: ± 0.01 | .XX°: ± 1.0° | DATE: 21/12/30 | PART NO: |
| FINISH: | | CHKD: Wu Hui | DATE: 21/12/30 |
| DRAWING NO: | | APPD: Ren An De | DATE: 21/12/30 |
| | | | SCALE: N/A |
| | | | PAGE: 1/1 |
| | | | UNITS: mm |
| | | | REV.: A |

| | | | |
|------|----------------------|------|------|
| REV. | REVISION DESCRIPTION | DATE | APPD |
| | | | |

NOTES

Available in 04 through 40 Circuits.
Mates with DL25034-Y Series Housing.
Material : Nylon UL94-V0(2).
Green Material RoHS Compliant.

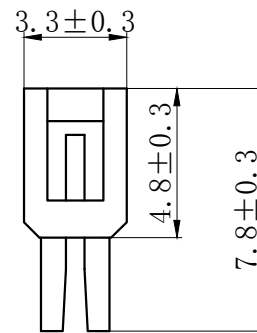
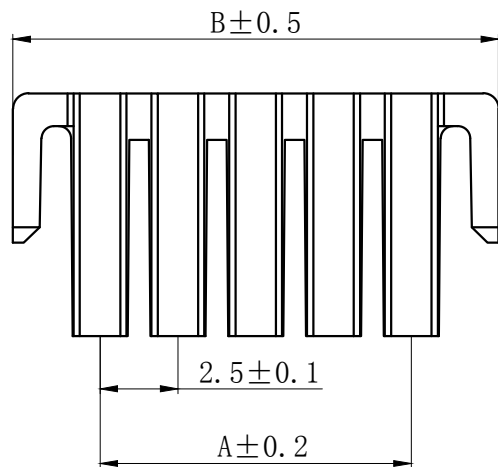
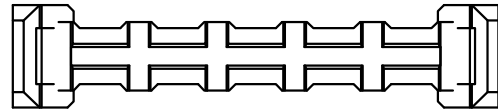

| Circuits | Product name | Dimension mm | | Circuits | Product name | Dimension mm | |
|----------|--------------|--------------|-------|----------|--------------|--------------|-------|
| | | A | B | | | A | B |
| 2x2 | XAD-4S | 2.50 | 8.10 | 2x10 | XAD-20S | 22.50 | 28.10 |
| 2x3 | XAD-6S | 5.00 | 10.60 | 2x11 | XAD-22S | 25.00 | 30.60 |
| 2x4 | XAD-8S | 7.50 | 13.10 | 2x12 | XAD-24S | 27.50 | 33.10 |
| 2x5 | XAD-10S | 10.00 | 15.60 | 2x13 | XAD-26S | 30.00 | 35.60 |
| 2x6 | XAD-12S | 12.50 | 18.10 | 2x14 | XAD-28S | 32.50 | 38.10 |
| 2x7 | XAD-14S | 15.00 | 20.60 | 2x15 | XAD-30S | 35.00 | 40.60 |
| 2x8 | XAD-16S | 17.50 | 23.10 | - | - | - | - |
| 2x9 | XAD-18S | 20.00 | 25.60 | 2x20 | XAD-40S | 47.50 | 53.10 |

| | | | |
|--|--------------|------------------------------------|---------------------------------|
| GENERAL TOLERANCES (UNLESS SPECIFIED) | | ZHE JIANG DELI CONNECTORS CO., LTD | |
| .X: ± 0.25 | X°: ± 3.0° | PRODUCT NAME: DL25034 (XAD)-S | TITLE: 2.50 mm Pitch Housing |
| .XX: ± 0.15 | .X°: ± 2.0° | DR: Chen Quan Long | DATE: 19/08/01 |
| .XXX: ± 0.01 | .XX°: ± 1.0° | DATE: 19/08/01 | PART NO: |
| FINISH: | | CHKD: Wu Hui | DATE: 19/08/01 |
| DRAWING NO: | | APPD: Ren An De | DATE: 19/08/01 |
| | | SCALE: N/A | PAGE: 1/1 |
| | | UNITS: mm | REV.: A |

| REV. | REVISION DESCRIPTION | DATE | APPD |
|------|----------------------|------|------|
| | | | |

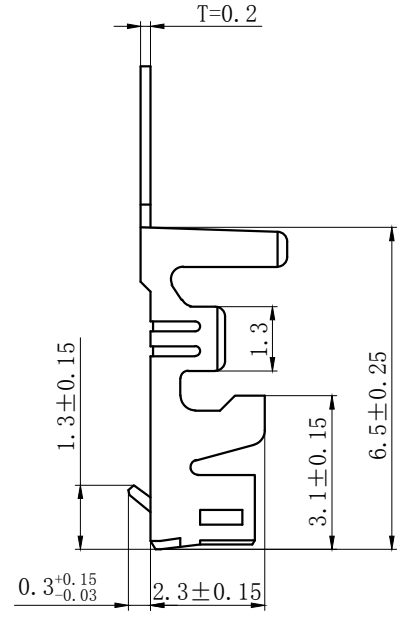
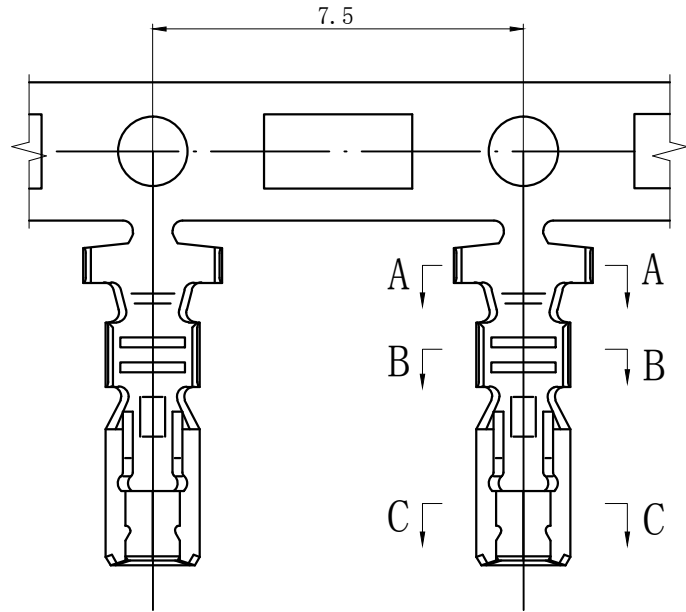

技术特性/Specifications:

额定电压Rated voltage :250V AC.DC.
 额定电流Rated current :3A AC.DC.
 接触电阻Contact resistance:20MΩ MAX
 绝缘电阻Insulation resistance: 1000 MΩ MIN
 耐压Withstand voltage:1000V AC/minute
 环境温度Ambient temperature: -40℃~+105℃
 适用线规 Wire range: AWG#28~#20

材料/Materials:

端子Terminal: 磷青铜Phosphor bronze ,
 镀锡Tin plated

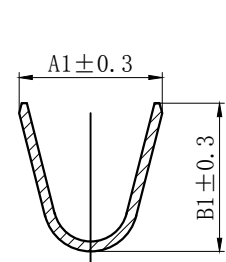

SECTION A-A

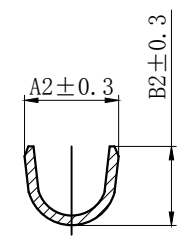

SECTION B-B

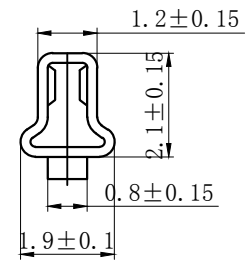

SECTION C-C

| Product name | Dimension (mm) | | | | Applicable wire | Insulation O. D. (mm) |
|--------------|----------------|-----|-----|-----|-----------------|-----------------------|
| | A1 | B1 | A2 | B2 | | |
| DL25018-T | 2.9 | 3.0 | 1.9 | 1.6 | AWG#28-22 | 1.9mm Max |
| DL25018-T-G | 2.9 | 3.0 | 2.3 | 2.1 | AWG#24-20 | 1.9mm Max |

| GENERAL TOLERANCES (UNLESS SPECIFIED) | | | | ZHE JIANG DELI CONNECTORS CO., LTD | | | |
|---------------------------------------|--------------|----------------------------|--|---|---------|---------------|-----------|
| .X: ± 0.25 | X°: ± 3.0° | PRODUCT NAME: DL25018-T | | TITLE: 2.50 mm Pitch Crimp Terminal | | | |
| .XX: ± 0.15 | .X°: ± 2.0° | DR: Yuan Jun Rong | | DATE:21/12/30 | | PART NO: | |
| .XXX: ± 0.01 | .XX°: ± 1.0° | FINISH: | | CHKD: Wu Hui | | DATE:21/12/30 | |
| DRAWING NO: | | APPD:Ren An De | | DATE:21/12/30 | | SCALE: N/A | PAGE: 1/1 |
| | | | | UNITS: mm | REV.: A | | |

| REV. | REVISION DESCRIPTION | DATE | APPD |
|------|----------------------|------|------|
| | | | |

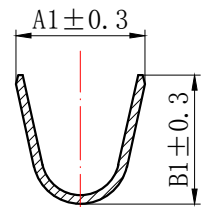
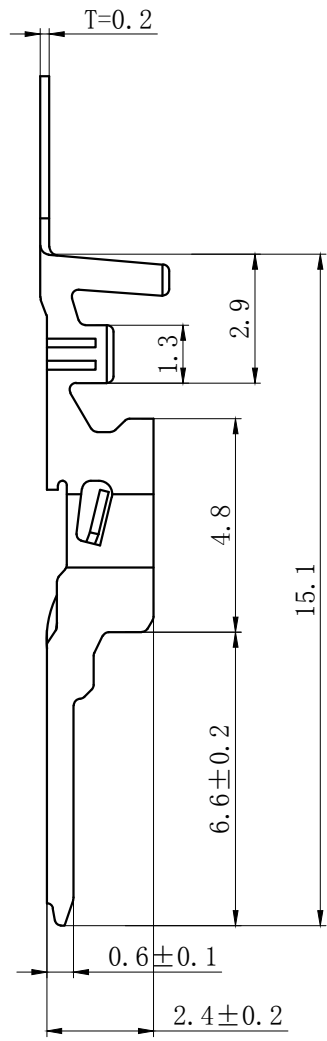
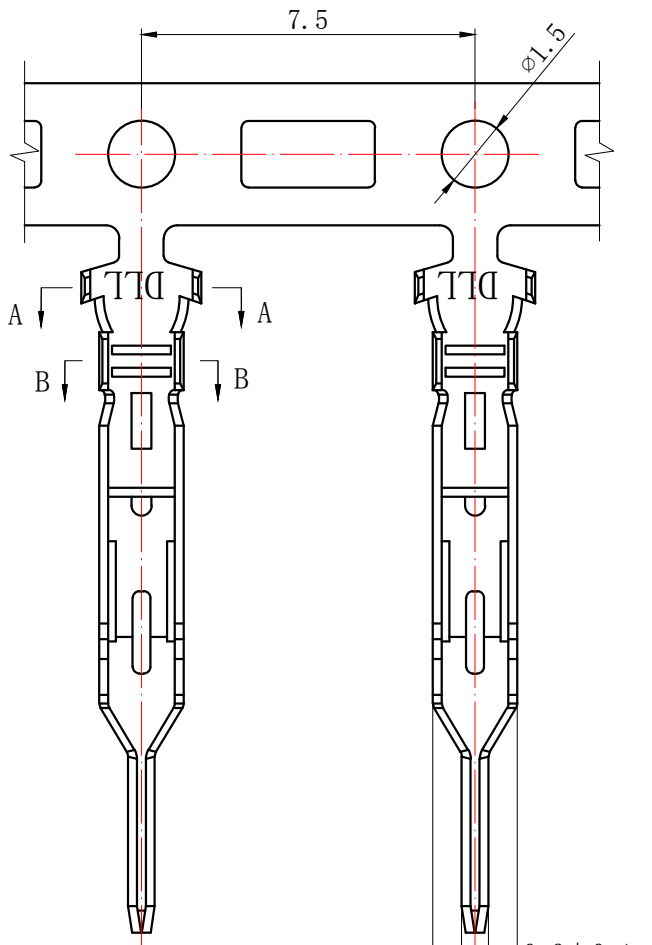

SECTION A-A

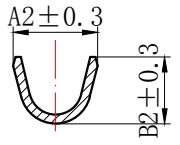

SECTION B-B

技术特性/Specifications:

额定电压 Rated voltage : 250V AC.DC.
 额定电流 Rated current : 3A AC.DC.
 接触电阻 Contact resistance: 20MΩ MAX
 绝缘电阻 Insulation resistance: 500 MΩ MIN
 耐压 Withstand voltage: 1500V AC/minute
 环境温度 Ambient temperature: -40℃ ~ +105℃
 适用线规 Wire range: AWG#28 ~ #20

材料/Materials:

端子 Terminal: 磷青铜 Phosphor bronze ,
 镀锡 Tin plated

| Product name | Dimension (mm) | | | | Applicable wire | Insulation O.D. (mm) |
|--------------|----------------|-----|-----|-----|-----------------|----------------------|
| | A1 | B1 | A2 | B2 | | |
| DL25018-RT | 2.9 | 2.9 | 1.9 | 1.5 | AWG#28-22 | 1.9mm Max |
| DL25018-RT-G | 2.9 | 2.9 | 2.2 | 2.1 | AWG#24-20 | 1.9mm Max |

| | | | |
|---------------------------------------|--------------|------------------------------------|--|
| GENERAL TOLERANCES (UNLESS SPECIFIED) | | ZHE JIANG DELI CONNECTORS CO., LTD | |
| .X: ± 0.25 | X°: ± 3.0° | PRODUCT NAME: | TITLE: |
| .XX: ± 0.15 | .X°: ± 2.0° | DL25018-RT | 2.50 mm Pitch Wire To Wire Terminal |
| .XXX: ± 0.01 | .XX°: ± 1.0° | DR: Yuan Jun Rong | DATE: 21/12/30 |
| FINISH: | | CHKD: Wu Hui | DATE: 21/12/30 |
| DRAWING NO: | | APPD: Ren An De | DATE: 21/12/30 |
| | | | PART NO: |
| | | | SCALE: N/A |
| | | | PAGE: 1/1 |
| | | | UNITS: mm |
| | | | REV.: A |

X-ON Electronics

Largest Supplier of Electrical and Electronic Components

Click to view similar products for [Headers & Wire Housings](#) category:

Click to view products by [DLL](#) manufacturer:

Other Similar products are found below :

[0015917161](#) [0022155065](#) [57102-F02-18ULF](#) [58102-G61-06LF](#) [582553-1](#) [01.001.5753.1](#) [0050291907](#) [02.125.8002.8](#) [609-3404](#) [61062-3](#)
[CSU011177004](#) [622-0430](#) [622-3653LF](#) [63453-116](#) [636-1030](#) [636-1427](#) [636-3427](#) [636-4007](#) [641938-9](#) [65495-038](#) [65692-001LF](#) [65781-018](#)
[65781-047](#) [65817-010LF](#) [65817-015LF](#) [67095-007LF](#) [67601157](#) [68631-112](#) [68645-018](#) [699319-000](#) [70.362.1628.0](#) [70-4210](#) [70-4226B](#) [70-](#)
[4853B](#) [71.350.2428.0](#) [733-134](#) [733-162](#) [760-3052](#) [MHR-64-VUAL](#) [80.063.4001.1](#) [800-90-001-10-001000](#) [801-43-002-10-013000](#)
[801-43-006-10-002000](#) [803-43-024-10-001000](#) [803-93-012-10-001000](#) [8-1437020-4](#) [819-22-004-30-001101](#) [820-22-006-30-001101](#)
[820-22-008-30-001101](#) [821-22-002-10-001101](#)