

**技术特性/Specifications:**

额定电压 Rated voltage: 250V AC, DC  
额定电流 Rated current: 3A AC, DC  
接触电阻 Contact resistance: 20m $\Omega$  max  
绝缘电阻 Insulation resistance: 1000M $\Omega$  min  
耐压 Withstand voltage: 1000V AC/minute  
环境温度 Ambient temperature: -40 $^{\circ}$ C~+105 $^{\circ}$ C  
适用线规 Wire range: AWG#28~#20

REV.	REVISION	DESCRIPTION	DATE	APPD

**NORES:**

1. Rated voltage: 250V AC/DC
2. Rated current: 3A AC/DC
3. Contact resistance:  $\leq 20 \text{ m}\Omega$
4. Insulation resistance:  $\geq 1000 \text{ m}\Omega$
5. Withstand voltage: 1000V AC/minute
6. Ambient temperature:  $-40^\circ\text{C} \sim 105^\circ\text{C}$
7. Materials: Nylon UL94V-0(2)
8. Matched RoHS criteria



Circuit No.1  
2x2~2x8PIN  
C±0.2



Circuit No.2

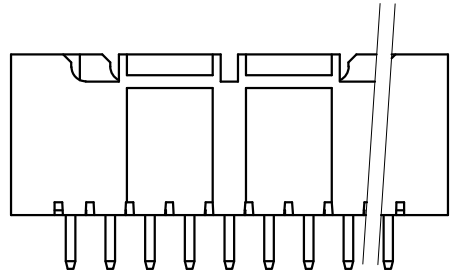

2x9PIN以上



PCB LAYOUT

Circuits	Product name	Dimensino (mm)			Circuits	Product name	Dimensino (mm)		
		A	B	C			A	B	C
2x2	XAD-4A	2.5	10.0	6.4	2x10	XAD-20A	22.5	30.0	26.4
2x3	XAD-6A	5.0	12.5	8.9	2x11	XAD-22A	25.0	32.5	28.9
2x4	XAD-8A	7.5	15.0	11.4	2x12	XAD-24A	27.5	35.0	31.4
2x5	XAD-10A	10.0	17.5	13.9	2x13	XAD-26A	30.0	37.5	33.9
2x6	XAD-12A	12.5	20.0	16.4	2x14	XAD-28A	32.5	40.0	36.4
2x7	XAD-14A	15.0	22.5	18.9	2x15	XAD-30A	35.0	42.5	38.9
2x8	XAD-16A	17.5	25.0	21.4	~	~	~	~	~
2x9	XAD-18A	20.0	27.5	23.9	2x20	XAD-40A	47.5	55.0	51.4

GENERAL TOLERANCES (UNLESS SPECIFIED)		ZHE JIANG DELI CONNECTORS CO., LTD	
.X: ± 0.25	X°: ± 3.0°	PRODUCT NAME: DL25034 (XAD)-A	TITLE: 2.50 mm Pitch Wire To Board Wafer
.XX: ± 0.15	.X°: ± 2.0°	DR: Chen Quan Long	DATE:21/08/01
.XXX: ± 0.01	.XX°: ± 1.0°	CHKD: Wu Hui	DATE:21/08/01
FINISH:		APPD: Ren An De	DATE:21/08/01
DRAWING NO:		UNITS: mm	REV.: A
		PART NO:	SCALE: N/A
		PAGE: 1/1	

REV.	REVISION DESCRIPTION	DATE	APPD

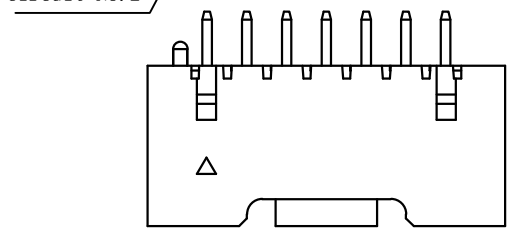
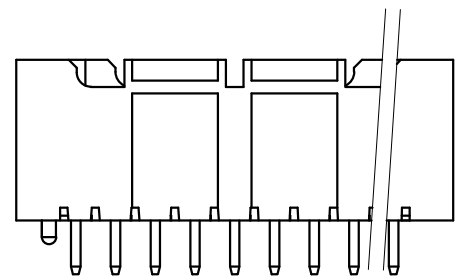
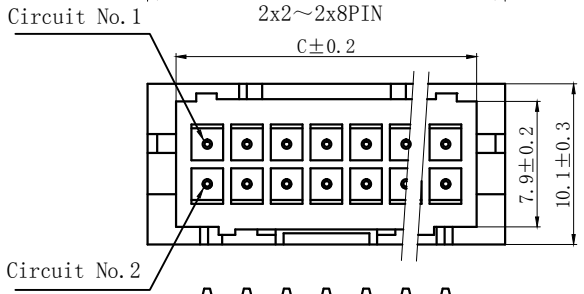

2x9PIN以上



**NORES:**

1. Rated voltage: 250V AC/DC
2. Rated current: 3A AC DC
3. Contact resistance:  $\leq 20 \text{ m}\Omega$
4. Insulation resistance:  $\geq 1000 \text{ m}\Omega$
5. Withstand voltage: 1000V AC/minute
6. Ambient temperature:  $-40^{\circ}\text{C} \sim 105^{\circ}\text{C}$
7. Materials: Nylon UL94V-0 (2)
8. Matched RoHS criteria

Circuits	Product name	Dimensino(mm)			Circuits	Product name	Dimensino(mm)		
		A	B	C			A	B	C
2x2	XAD-4AS	2.5	10.0	6.4	2x10	XAD-20AS	22.5	30.0	26.4
2x3	XAD-6AS	5.0	12.5	8.9	2x11	XAD-22AS	25.0	32.5	28.9
2x4	XAD-8AS	7.5	15.0	11.4	2x12	XAD-24AS	27.5	35.0	31.4
2x5	XAD-10AS	10.0	17.5	13.9	2x13	XAD-26AS	30.0	37.5	33.9
2x6	XAD-12AS	12.5	20.0	16.4	2x14	XAD-28AS	32.5	40.0	36.4
2x7	XAD-14AS	15.0	22.5	18.9	2x15	XAD-30AS	35.0	42.5	38.9
2x8	XAD-16AS	17.5	25.0	21.4	~	~	~	~	~
2x9	XAD-18AS	20.0	27.5	23.9	2x20	XAD-40AS	47.5	55.0	51.4

GENERAL TOLERANCES (UNLESS SPECIFIED)		ZHE JIANG DELI CONNECTORS CO., LTD	
.X: $\pm 0.25$	X°: $\pm 3.0^{\circ}$	PRODUCT NAME: DL25034(XAD)-AS	TITLE: 2.50 mm Pitch Wire To Board Wafer
.XX: $\pm 0.15$	.X°: $\pm 2.0^{\circ}$	DR: Chen Quan Long	DATE: 21/08/01
.XXX: $\pm 0.01$	.XX°: $\pm 1.0^{\circ}$	CHKD: Wu Hui	DATE: 21/08/01
FINISH:		APPD: Ren An De	DATE: 21/08/01
DRAWING NO:		SCALE: N/A	PAGE: 1/1
		UNITS: mm	REV.: A

REV.	REVISION DESCRIPTION	DATE	APPD

**NORES:**

1. Rated voltage: 250V AC/DC
2. Rated current: 3A AC/DC
3. Contact resistance:  $\leq 20 \text{ m}\Omega$
4. Insulation resistance:  $\geq 1000 \text{ m}\Omega$
5. Withstand voltage: 1000V AC/minute
6. Ambient temperature:  $-45^\circ\text{C} \sim 105^\circ\text{C}$
7. Materials: Nylon UL94V-0(2)
8. Matched RoHS criteria

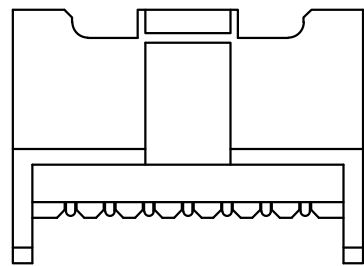

4-16PIN

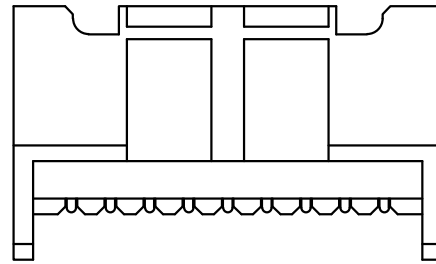

18-40PIN

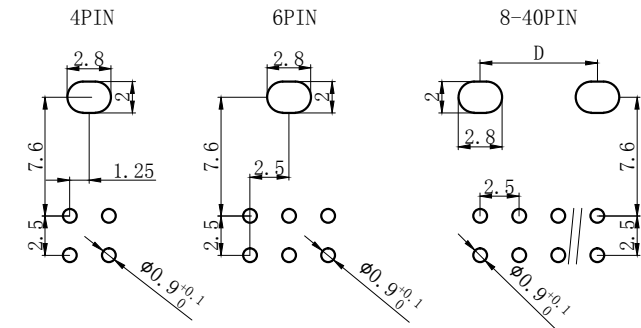
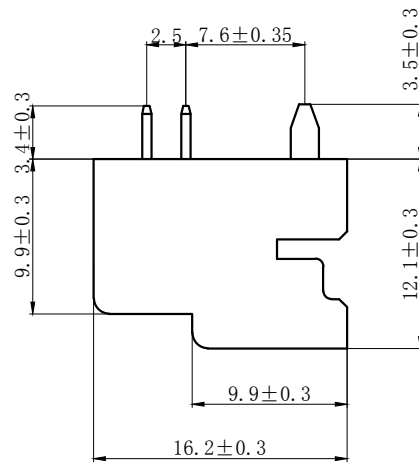
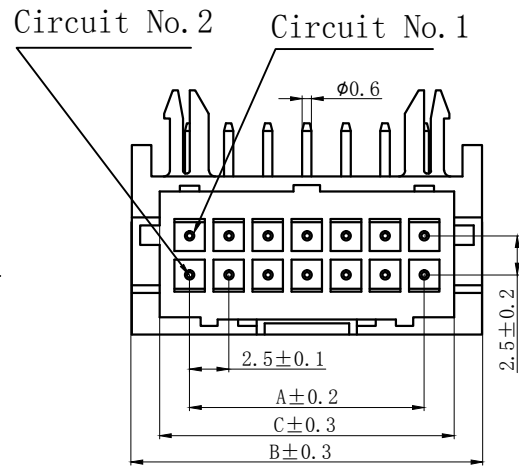

PCB LAYOUT

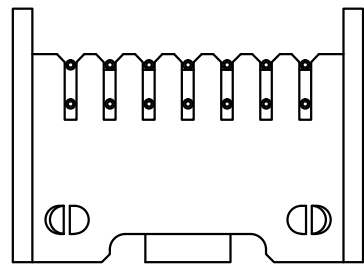

Circuits	Product name	Dimensino (mm)				Circuits	Product name	Dimensino (mm)			
		A	B	C	D			A	B	C	D
2x2	XAD-4AWD-S	2.5	10.0	6.4	/	2x10	XAD-20AWD-S	22.5	30.0	26.4	22.5
2x3	XAD-6AWD-S	5.0	12.5	8.9	/	2x11	XAD-22AWD-S	25.0	32.5	28.9	25.0
2x4	XAD-8AWD-S	7.5	15.0	11.4	7.5	2x12	XAD-24AWD-S	27.5	35.0	31.4	27.5
2x5	XAD-10AWD-S	10.0	17.5	13.9	10.0	2x13	XAD-26AWD-S	30.0	37.5	33.9	30.0
2x6	XAD-12AWD-S	12.5	20.0	16.4	12.5	2x14	XAD-28AWD-S	32.5	40.0	36.4	32.5
2x7	XAD-14AWD-S	15.0	22.5	18.9	15.0	2x15	XAD-30AWD-S	35.0	42.5	38.9	35.0
2x8	XAD-16AWD-S	17.5	25.0	21.4	17.5	~	~	~	~	~	~
2x9	XAD-18AWD-S	20.0	27.5	23.9	20.0	2x20	XAD-40AWD-S	47.5	55.0	51.4	47.5

<b>GENERAL TOLERANCES (UNLESS SPECIFIED)</b>		<b>ZHE JIANG DELI CONNECTORS CO., LTD</b>	
.X: ± 0.25	X°: ± 3.0°	PRODUCT NAME: DL25034(XAD)-AWD-S	
.XX: ± 0.15	.X°: ± 2.0°	TITLE: 2.50 mm Pitch Wire To Board Wafer	
.XXX: ± 0.01	.XX°: ± 1.0°	DR: Yuan Jun Rong	DATE: 21/08/01
FINISH:		CHKD: Wu Hui	DATE: 21/08/01
DRAWING NO:		APPD: Ren An De	DATE: 21/08/01
		PART NO:	
		SCALE: N/A	PAGE: 1/1
		UNITS: mm	REV.: A

REV.	REVISION DESCRIPTION	DATE	APPD

## NOTES

Available in 04 through 40 Circuits.

Match with DL25034 series housing

Material : Nylon UL94V-0(2).

Accepts DL25034-T Crimp Terminal.

Circuit No.2

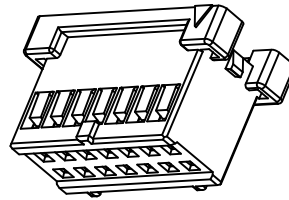
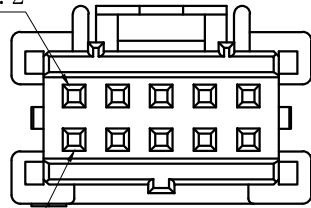

Circuit No.1

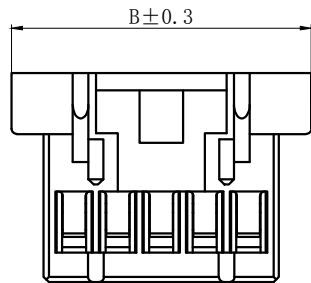

2X2-2X8PIN

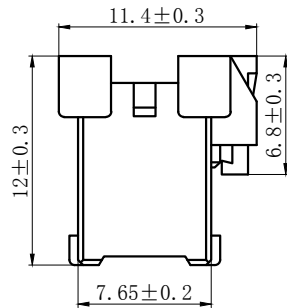

2X9-2X20PIN



Circuits	Product name	Dimension mm		Circuits	Product name	Dimension mm	
		A	B			A	B
2X2	XAD-4Y	2.50	9.70	2X12	XAD-24Y	27.50	34.70
2X3	XAD-6Y	5.00	12.20	2X13	XAD-26Y	30.00	37.20
2X4	XAD-8Y	7.50	14.70	2X14	XAD-28Y	32.50	39.70
2X5	XAD-10Y	10.00	17.20	2X15	XAD-30Y	35.00	42.20
2X6	XAD-12Y	12.50	19.70	2X16	XAD-32Y	37.50	44.70
2X7	XAD-14Y	15.00	22.20	2X17	XAD-34Y	40.00	47.20
2X8	XAD-16Y	17.50	24.70	2X18	XAD-36Y	42.50	49.70
2X9	XAD-18Y	20.00	27.20	2X19	XAD-38Y	45.00	52.20
2X10	XAD-20Y	22.50	29.70	2X20	XAD-40Y	47.50	54.70
2X11	XAD-22Y	25.00	32.20				

GENERAL TOLERANCES  
(UNLESS SPECIFIED)

.X: ± 0.25	X° : ± 3.0°
.XX: ± 0.15	.X° : ± 2.0°
.XXX: ± 0.01	.XX° : ± 1.0°

FINISH: \_\_\_\_\_

DRAWING NO: \_\_\_\_\_

ZHE JIANG DELI CONNECTORS CO., LTD

PRODUCT NAME: DL25034 (XAD)-Y  
TITLE: 2.50 mm Pitch Housing

DR: Chen Quan Long DATE: 19/08/01  
PART NO:

CHKD: Wu Hui DATE: 19/08/01  
SCALE: N/A PAGE: 1/1

APPD: Ren An De DATE: 19/08/01  
UNITS: mm REV.: A

REV.	REVISION DESCRIPTION	DATE	APPD

**NORES:**

1. Rated voltage: 250V AC/DC
2. Rated current: 3A AC/DC
3. Contact resistance:  $\leq 10 \text{ m}\Omega$
4. Insulation resistance:  $\geq 500 \text{ m}\Omega$
5. Withstand voltage: 1500V AC/minute
6. Ambient temperature:  $-40^\circ\text{C} \sim 105^\circ\text{C}$
7. Materials: Nylon UL94V-0 (2)
8. Matched RoHS criteria



安装尺寸图

Circuits	Product name	Dimension mm			Circuits	Product name	Dimension mm		
		A	B	C			A	B	C
2X2	XAD-4R	2.50	7.90	11.20	2X12	XAD-24R	27.50	32.90	36.20
2X3	XAD-6R	5.00	10.40	13.70	2X13	XAD-26R	30.00	35.40	38.70
2X4	XAD-8R	7.50	12.90	16.20	2X14	XAD-28R	32.50	37.90	41.20
2X5	XAD-10R	10.00	15.40	18.70	2X15	XAD-30R	35.00	40.40	43.70
2X6	XAD-12R	12.50	17.90	21.20	2X16	XAD-32R	37.50	42.90	46.20
2X7	XAD-14R	15.00	20.40	23.70	2X17	XAD-34R	40.00	45.40	48.70
2X8	XAD-16R	17.50	22.90	26.20	2X18	XAD-36R	42.50	47.90	51.20
2X9	XAD-18R	20.00	25.40	28.70	2X19	XAD-38R	45.00	50.40	53.70
2X10	XAD-20R	22.50	27.90	31.20	2X20	XAD-40R	47.50	52.90	56.20
2X11	XAD-22R	25.00	30.40	33.70					

GENERAL TOLERANCES (UNLESS SPECIFIED)		ZHE JIANG DELI CONNECTORS CO., LTD	
.X: ± 0.25	X°: ± 3.0°	PRODUCT NAME: <b>DL25034 (XAD)-R</b>	TITLE: 2.50 mm Pitch Wire To Wire Housing
.XX: ± 0.15	.X°: ± 2.0°	DR: Yuan Jun Rong	DATE: 21/12/30
.XXX: ± 0.01	.XX°: ± 1.0°	DATE: 21/12/30	PART NO:
FINISH:		CHKD: Wu Hui	DATE: 21/12/30
DRAWING NO:		APPD: Ren An De	DATE: 21/12/30
			SCALE: N/A
			PAGE: 1/1
			UNITS: mm
			REV.: A

REV.	REVISION DESCRIPTION	DATE	APPD

### NOTES

Available in 04 through 40 Circuits.  
Mates with DL25034-Y Series Housing.  
Material : Nylon UL94-V0(2).  
Green Material RoHS Compliant.

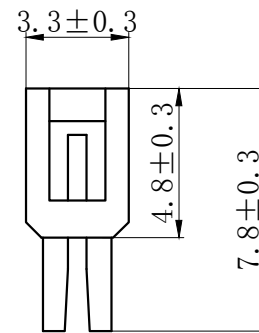
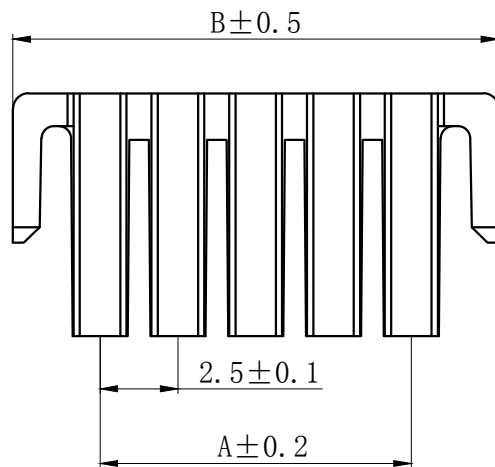

Circuits	Product name	Dimension mm		Circuits	Product name	Dimension mm	
		A	B			A	B
2x2	XAD-4S	2.50	8.10	2x10	XAD-20S	22.50	28.10
2x3	XAD-6S	5.00	10.60	2x11	XAD-22S	25.00	30.60
2x4	XAD-8S	7.50	13.10	2x12	XAD-24S	27.50	33.10
2x5	XAD-10S	10.00	15.60	2x13	XAD-26S	30.00	35.60
2x6	XAD-12S	12.50	18.10	2x14	XAD-28S	32.50	38.10
2x7	XAD-14S	15.00	20.60	2x15	XAD-30S	35.00	40.60
2x8	XAD-16S	17.50	23.10	-	-	-	-
2x9	XAD-18S	20.00	25.60	2x20	XAD-40S	47.50	53.10

GENERAL TOLERANCES (UNLESS SPECIFIED)				ZHE JIANG DELI CONNECTORS CO., LTD			
.X: ± 0.25	X°: ± 3.0°	PRODUCT NAME: DL25034 (XAD)-S		TITLE: 2.50 mm Pitch Housing			
.XX: ± 0.15	.X°: ± 2.0°	DR: Chen Quan Long		DATE: 19/08/01		PART NO:	
.XXX: ± 0.01	.XX°: ± 1.0°	CHKD: Wu Hui		DATE: 19/08/01		SCALE: N/A	PAGE: 1/1
FINISH: _____		APPD: Ren An De		DATE: 19/08/01		UNITS: mm	REV.: A

REV.	REVISION DESCRIPTION	DATE	APPD



技术特性/Specifications:

额定电压Rated voltage :250V AC.DC.  
 额定电流Rated current :3A AC.DC.  
 接触电阻Contact resistance:20MΩ MAX  
 绝缘电阻Insulation resistance: 1000 MΩ MIN  
 耐压Withstand voltage:1000V AC/minute  
 环境温度Ambient temperature: -40℃~+105℃  
 适用线规 Wire range: AWG#28~#20

材料/Materials:

端子Terminal: 磷青铜Phosphor bronze ,  
 镀锡Tin plated



SECTION A-A



SECTION B-B



SECTION C-C

Product name	Dimension (mm)				Applicable wire	Insulation O. D. (mm)
	A1	B1	A2	B2		
DL25018-T	2.9	3.0	1.9	1.6	AWG#28-22	1.9mm Max
DL25018-T-G	2.9	3.0	2.3	2.1	AWG#24-20	1.9mm Max

GENERAL TOLERANCES (UNLESS SPECIFIED)				ZHE JIANG DELI CONNECTORS CO., LTD			
.X: ± 0.25	X°: ± 3.0°	PRODUCT NAME: DL25018-T		TITLE: 2.50 mm Pitch Crimp Terminal			
.XX: ± 0.15	.X°: ± 2.0°	DR: Yuan Jun Rong		DATE:21/12/30		PART NO:	
.XXX: ± 0.01	.XX°: ± 1.0°	FINISH:		CHKD: Wu Hui		DATE:21/12/30	
DRAWING NO:		APPD:Ren An De		DATE:21/12/30		SCALE: N/A	PAGE: 1/1
				UNITS: mm	REV.: A		



REV.	REVISION DESCRIPTION	DATE	APPD



SECTION A-A



SECTION B-B

技术特性/Specifications:

额定电压 Rated voltage : 250V AC.DC.  
 额定电流 Rated current : 3A AC.DC.  
 接触电阻 Contact resistance: 20MΩ MAX  
 绝缘电阻 Insulation resistance: 500 MΩ MIN  
 耐压 Withstand voltage: 1500V AC/minute  
 环境温度 Ambient temperature: -40℃ ~ +105℃  
 适用线规 Wire range: AWG#28 ~ #20

材料/Materials:

端子 Terminal: 磷青铜 Phosphor bronze ,  
 镀锡 Tin plated

Product name	Dimension (mm)				Applicable wire	Insulation O.D. (mm)
	A1	B1	A2	B2		
DL25018-RT	2.9	2.9	1.9	1.5	AWG#28-22	1.9mm Max
DL25018-RT-G	2.9	2.9	2.2	2.1	AWG#24-20	1.9mm Max

GENERAL TOLERANCES (UNLESS SPECIFIED)		ZHE JIANG DELI CONNECTORS CO., LTD	
.X: ± 0.25	X°: ± 3.0°	PRODUCT NAME:	TITLE:
.XX: ± 0.15	.X°: ± 2.0°	DL25018-RT	2.50 mm Pitch Wire To Wire Terminal
.XXX: ± 0.01	.XX°: ± 1.0°	DR: Yuan Jun Rong	DATE: 21/12/30
FINISH:		CHKD: Wu Hui	DATE: 21/12/30
DRAWING NO:		APPD: Ren An De	DATE: 21/12/30
			PART NO:
			SCALE: N/A
			PAGE: 1/1
			UNITS: mm
			REV.: A

## X-ON Electronics

Largest Supplier of Electrical and Electronic Components

*Click to view similar products for [Headers & Wire Housings](#) category:*

*Click to view products by [DLL](#) manufacturer:*

Other Similar products are found below :

[0015917161](#) [0022155065](#) [57102-F02-18ULF](#) [58102-G61-06LF](#) [582553-1](#) [01.001.5753.1](#) [0050291907](#) [02.125.8002.8](#) [609-3404](#) [61062-3](#)  
[CSU011177004](#) [622-0430](#) [622-3653LF](#) [63453-116](#) [636-1030](#) [636-1427](#) [636-3427](#) [636-4007](#) [641938-9](#) [65495-038](#) [65692-001LF](#) [65781-018](#)  
[65781-047](#) [65817-010LF](#) [65817-015LF](#) [67095-007LF](#) [67601157](#) [68631-112](#) [68645-018](#) [699319-000](#) [70.362.1628.0](#) [70-4210](#) [70-4226B](#) [70-](#)  
[4853B](#) [71.350.2428.0](#) [733-134](#) [733-162](#) [MHR-64-VUAL](#) [80.063.4001.1](#) [800-90-001-10-001000](#) [801-43-002-10-013000](#) [801-43-006-10-](#)  
[002000](#) [803-43-024-10-001000](#) [803-93-012-10-001000](#) [8-1437020-4](#) [819-22-004-30-001101](#) [820-22-006-30-001101](#) [820-22-008-30-001101](#)  
[821-22-002-10-001101](#) [821-22-003-10-002101](#)