

## 技术特性/Specifications:

额定电压 Rated voltage: 250V AC, DC  
额定电流 Rated current: 3A AC, DC  
接触电阻 Contact resistance: 20mΩ max  
绝缘电阻 Insulation resistance: 1000MΩ min  
耐压 Withstand voltage: 1000V AC/minute  
环境温度 Ambient temperature: -40℃~+105℃  
适用线规 Wire range: AWG#32~#28



REV.	REVISION DESCRIPTION	DATE	APPD



SECTION A-A



NORES:

- 1、Rated voltage: 250V AC DC
- 2、Rated current: 3A AC DC
- 3、Contact resistance:  $\leq 20 \text{ m}\Omega$
- 4、Insulation resistance:  $\geq 1000 \text{ m}\Omega$
- 5、Withstand voltage: 1000V AC/minute
- 6、Ambient temprature:  $-25^{\circ}\text{C} \sim 85^{\circ}\text{C}$
- 7、Materials:LCP UL94V-0
- 8、Matched RoHS criteria



3	③	基座	LCP	1	UL94-V0
2	②	焊片	黄铜	2	镀锡
1	①	接触件	黄铜	N*	镀锡
序号	图号	名称	材料	数量	附件

Circuits	Product name	Dimension mm		Circuits	Product name	Dimension mm	
		A	B			A	B
2	DL25018-2AB	2.50	10.00	10	DL25018-10AB	22.50	30.00
3	DL25018-3AB	5.00	12.50	11	DL25018-11AB	25.00	32.50
4	DL25018-4AB	7.50	15.00	12	DL25018-12AB	27.50	35.00
5	DL25018-5AB	10.00	17.50	13	DL25018-13AB	30.00	37.50
6	DL25018-6AB	12.50	20.00	14	DL25018-14AB	32.50	40.00
7	DL25018-7AB	15.00	22.50	15	DL25018-15AB	35.00	42.50
8	DL25018-8AB	17.50	25.00	-	-	-	-
9	DL25018-9AB	20.00	27.50	20	DL25018-20AB	47.50	55.00

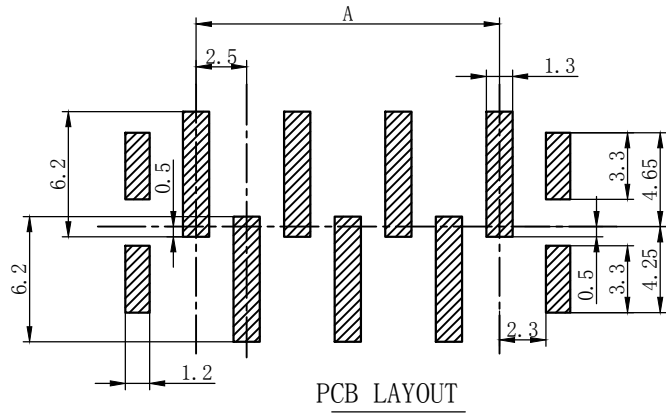

PCB LAYOUT

GENERAL TOLERANCES (UNLESS SPECIFIED)		ZHE JIANG DELI CONNECTORS CO., LTD	
.X: ± 0.25	X°: ± 3.0°	PRODUCT NAME:	TITLE: 2.50 mm Pitch Wire To Board SMT Wafer
.XX: ± 0.15	.X°: ± 2.0°	DL25018-AB	
.XXX: ± 0.01	.XX°: ± 1.0°	DR:Chen Quan Long	DATE:18/03/03
FINISH:		CHKD:Wu Hui	DATE:18/03/03
DRAWING NO:		APPD:Ren An De	DATE:18/03/03
			PART NO:
			SCALE: N/A
			PAGE: 1/1
			UNITS: mm
			REV.: B

REV.	REVISION DESCRIPTION	DATE	APPD

**NORES:**

- 1、Rated voltage: 250V AC DC
- 2、Rated current: 3A AC DC
- 3、Contact resistance:  $\leq 20 \text{ m}\Omega$
- 4、Insulation resistance:  $\geq 1000 \text{ m}\Omega$
- 5、Withstand voltage: 1000V AC/minute
- 6、Ambient temprature:  $-25^{\circ}\text{C} \sim 85^{\circ}\text{C}$
- 7、Materials:LCP UL94V-0
- 8、Matched RoHS criteria



3	③	基座	LCP	1	UL94-V0
2	②	焊片	黄铜	2	镀锡
1	①	接触件	黄铜	N*	镀锡
序号	图号	名称	材料	数量	附件

Circuit No.1



Circuits	Product name	Dimension mm		Circuits	Product name	Dimension mm	
		A	B			A	B
2	DL25018-2AWB	2.50	10.00	10	DL25018-10AWB	22.50	30.00
3	DL25018-3AWB	5.00	12.50	11	DL25018-11AWB	25.00	32.50
4	DL25018-4AWB	7.50	15.00	12	DL25018-12AWB	27.50	35.00
5	DL25018-5AWB	10.00	17.50	13	DL25018-13AWB	30.00	37.50
6	DL25018-6AWB	12.50	20.00	14	DL25018-14AWB	32.50	40.00
7	DL25018-7AWB	15.00	22.50	15	DL25018-15AWB	35.00	42.50
8	DL25018-8AWB	17.50	25.00	-	-	-	-
9	DL25018-9AWB	20.00	27.50	20	DL25018-20AWB	47.50	55.00



GENERAL TOLERANCES (UNLESS SPECIFIED)		ZHE JIANG DELI CONNECTORS CO., LTD	
.X: ± 0.25	X°: ± 3.0°	PRODUCT NAME:	TITLE: 2.50 mm Pitch Wire To Board SMT Wafer
.XX: ± 0.15	.X°: ± 2.0°	DL25018-AWB	PART NO:
.XXX: ± 0.01	.XX°: ± 1.0°	DR:Chen Quan Long	DATE:23/08/01
FINISH:		CHKD:Wu Hui	DATE:23/08/01
DRAWING NO:		APPD:Ren An De	DATE:23/08/01
		SCALE: N/A	PAGE: 1/1
		UNITS: mm	REV.: B

REV.	REVISION DESCRIPTION	DATE	APPD

### NOTES

Available in 02 through 20 Circuits.  
 Mates with DL25018-Y Series Housing.  
 Material : Nylon UL94V-0(2).  
 0.6mm round Pin.  
 Pin Material : Brass / Tin-Plated.

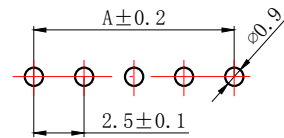
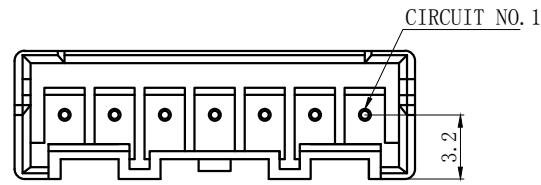

PCB LAYOUT

Circuits	Product name	Dimension mm		Circuits	Product name	Dimension mm	
		A	B			A	B
2	DL25018-2A	2.50	7.50	10	DL25018-10A	22.50	27.50
3	DL25018-3A	5.00	10.00	11	DL25018-11A	25.00	30.00
4	DL25018-4A	7.50	12.50	12	DL25018-12A	27.50	32.50
5	DL25018-5A	10.00	15.00	13	DL25018-13A	30.00	35.00
6	DL25018-6A	12.50	17.50	14	DL25018-14A	32.50	37.50
7	DL25018-7A	15.00	20.00	15	DL25018-15A	35.00	40.00
8	DL25018-8A	17.50	22.50	-	-	-	-
9	DL25018-9A	20.00	25.00	20	DL25018-20A	47.50	52.50

GENERAL TOLERANCES (UNLESS SPECIFIED)		ZHE JIANG DELI CONNECTORS CO., LTD	
.X: ± 0.25	X°: ± 3.0°	PRODUCT NAME: DL25018-A	TITLE: 2.50 mm Pitch Wire To Board Wafer
.XX: ± 0.15	.X°: ± 2.0°	DR: Chen Quan Long	DATE: 20/08/01
.XXX: ± 0.01	.XX°: ± 1.0°	CHKD: Wu Hui	DATE: 20/08/01
FINISH:		APPD: Ren An De	DATE: 20/08/01
DRAWING NO:			
		SCALE: N/A	PAGE: 1/1
		UNITS: mm	REV.: A

REV.	REVISION DESCRIPTION	DATE	APPD

### NOTES

Available in 02 through 20 Circuits.  
Mates with DL25018-Y Series Housing.  
Material : Nylon UL94V-0(2).  
0.6mm round Pin.  
Pin Material : Brass / Tin-Plated.

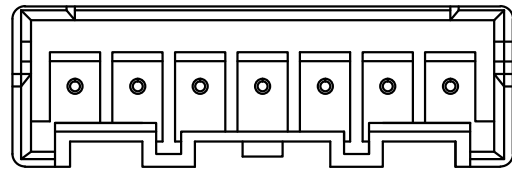

P. C. B LAYOUT

Circuits	Product name	Dimension mm		Circuits	Product name	Dimension mm	
		A	B			A	B
2	DL25018-2AS	2.50	7.50	10	DL25018-10AS	22.50	27.50
3	DL25018-3AS	5.00	10.00	11	DL25018-11AS	25.00	30.00
4	DL25018-4AS	7.50	12.50	12	DL25018-12AS	27.50	32.50
5	DL25018-5AS	10.00	15.00	13	DL25018-13AS	30.00	35.00
6	DL25018-6AS	12.50	17.50	14	DL25018-14AS	32.50	37.50
7	DL25018-7AS	15.00	20.00	15	DL25018-15AS	35.00	40.00
8	DL25018-8AS	17.50	22.50	-	-	-	-
9	DL25018-9AS	20.00	25.00	20	DL25018-20AS	47.50	52.50

GENERAL TOLERANCES (UNLESS SPECIFIED)		ZHE JIANG DELI CONNECTORS CO., LTD	
.X: ± 0.25	.X°: ± 3.0°	PRODUCT NAME: DL25018-AS	
.XX: ± 0.15	.XX°: ± 2.0°	TITLE: 2.50 mm Pitch Wire To Board Wafer	
.XXX: ± 0.01	.XXX°: ± 1.0°	DR: Ke Xian Qiang	DATE:09/08/01
FINISH:		CHKD: Liu Bing	DATE:09/08/01
DRAWING NO:		APPD:Ren An De	DATE:09/08/01
			PART NO:
			SCALE: N/A
			PAGE: 1/1
			UNITS: mm
			REV.: A

REV.	REVISION DESCRIPTION	DATE	APPD

### NOTES

Available in 02 through 20 Circuits.  
 Mates with DL25018-Y Series Housing.  
 Material : Nylon UL94V-0(2).  
 0.6mm round Pin.  
 Pin Material : Brass / Tin-Plated

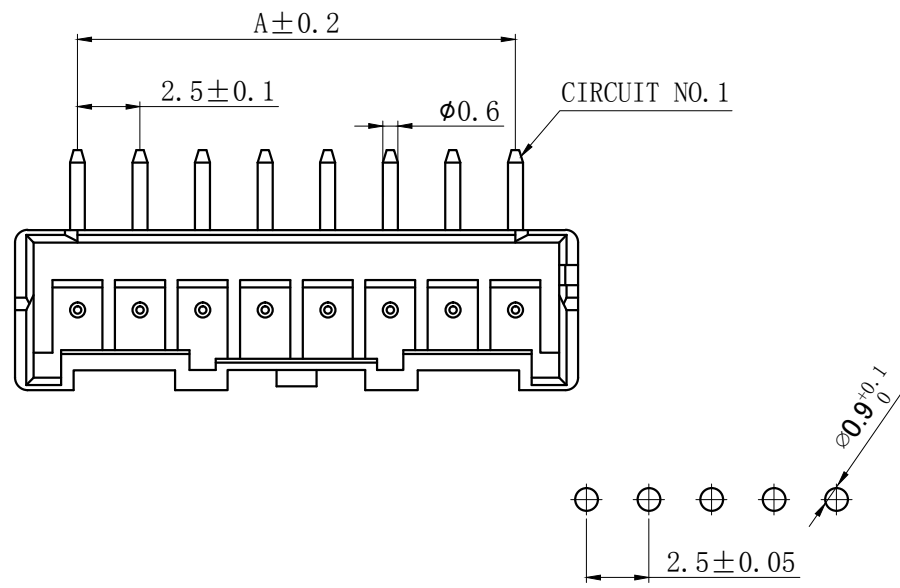

PCB LAYOUT

Circuits	Product name	Dimension mm		Circuits	Product name	Dimension mm	
		A	B			A	B
2	DL25018-2AWD	2.50	7.50	10	DL25018-10AWD	22.50	27.50
3	DL25018-3AWD	5.00	10.00	11	DL25018-11AWD	25.00	30.00
4	DL25018-4AWD	7.50	12.50	12	DL25018-12AWD	27.50	32.50
5	DL25018-5AWD	10.00	15.00	13	DL25018-13AWD	30.00	35.00
6	DL25018-6AWD	12.50	17.50	14	DL25018-14AWD	32.50	37.50
7	DL25018-7AWD	15.00	20.00	15	DL25018-15AWD	35.00	40.00
8	DL25018-8AWD	17.50	22.50	-	-	-	-
9	DL25018-9AWD	20.00	25.00	20	DL25018-20AWD	47.50	52.50

GENERAL TOLERANCES (UNLESS SPECIFIED)				ZHE JIANG DELI CONNECTORS CO., LTD			
.X: ± 0.25	X°: ± 3.0°	PRODUCT NAME: <b>DL25018-AWD</b>		TITLE: 2.50 mm Pitch Wire To Board Wafer			
.XX: ± 0.15	.X°: ± 2.0°	DR: Chen Quan Long	DATE: 20/08/01	PART NO:			
.XXX: ± 0.01	.XX°: ± 1.0°	CHKD: Wu Hui	DATE: 20/08/01	SCALE: N/A	PAGE: 1/1		
DRAWING NO:		APPD: Ren An De	DATE: 20/08/01	UNITS: mm	REV.: A		

REV.	REVISION DESCRIPTION	DATE	APPD

### NOTES

Available in 02 through 20 Circuits.  
 Mates with DL25018-Y Series Housing.  
 Material : Nylon UL94V-0(2).  
 0.6mm round Pin.  
 Pin Material : Brass / Tin-Plated.

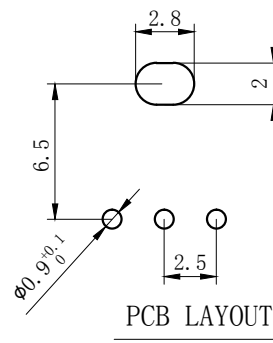
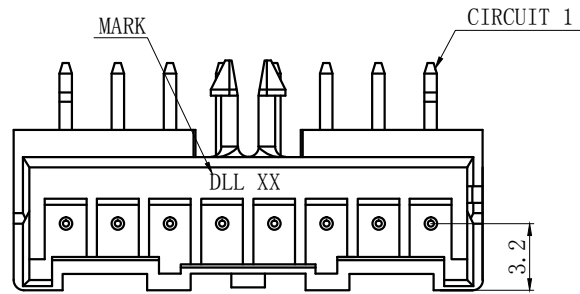
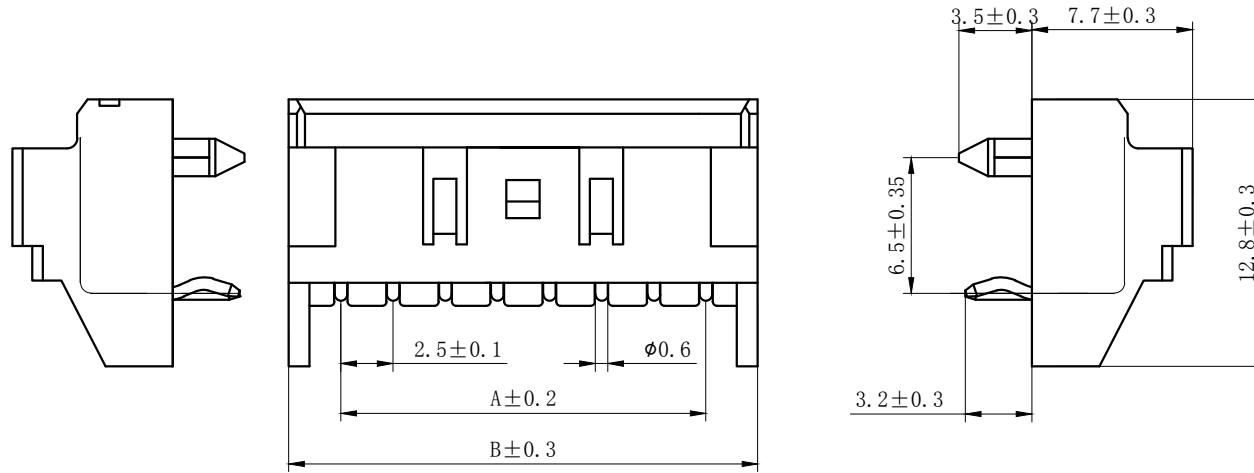

Circuits	Product name	Dimension mm		Circuits	Product name	Dimension mm	
		A	B			A	B
2	DL25018-2AWD-S	2.50	7.50	10	DL25018-10AWD-S	22.50	27.50
3	DL25018-3AWD-S	5.00	10.00	11	DL25018-11AWD-S	25.00	30.00
4	DL25018-4AWD-S	7.50	12.50	12	DL25018-12AWD-S	27.50	32.50
5	DL25018-5AWD-S	10.00	15.00	13	DL25018-13AWD-S	30.00	35.00
6	DL25018-6AWD-S	12.50	17.50	14	DL25018-14AWD-S	32.50	37.50
7	DL25018-7AWD-S	15.00	20.00	15	DL25018-15AWD-S	35.00	40.00
8	DL25018-8AWD-S	17.50	22.50	-	-	-	-
9	DL25018-9AWD-S	20.00	25.00	20	DL25018-20AWD-S	47.50	52.50

GENERAL TOLERANCES (UNLESS SPECIFIED)		ZHE JIANG DELI CONNECTORS CO., LTD	
.X: ± 0.25	X° : ± 3.0°	PRODUCT NAME: DL25018-AWD-S	
.XX: ± 0.15	.X° : ± 2.0°	TITLE: 2.50 mm Pitch Wire To Board Wafer	
.XXX: ± 0.01	.XX° : ± 1.0°	DR: Chen Quan Long	DATE: 20/08/01
FINISH:		CHKD: Wu Hui	DATE: 20/08/01
DRAWING NO:		APPD: Ren An De	DATE: 20/08/01
		PART NO:	
		SCALE: N/A	PAGE: 1/1
		UNITS: mm	REV.: A

REV.	REVISION DESCRIPTION	DATE	APPD

### NOTES

Available in 02 through 20 Circuits.  
 Match with DL25018 series housing  
 Material : Nylon UL94V-0(2).  
 Accepts DL25018-T Crimp Terminal.

CIRCUIT NO. 1

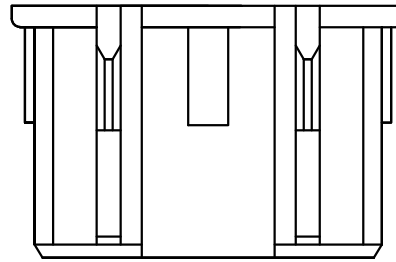
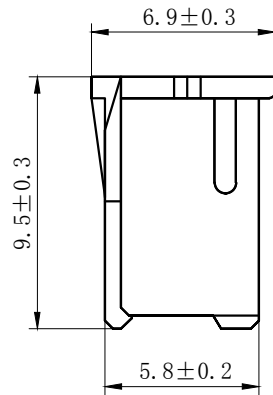
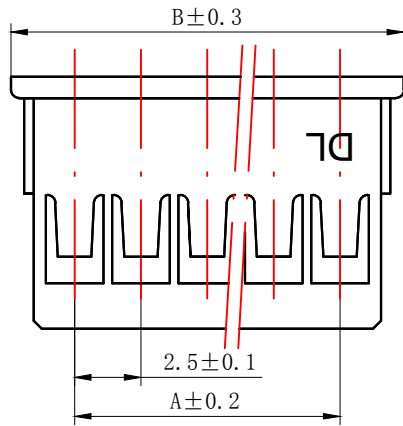
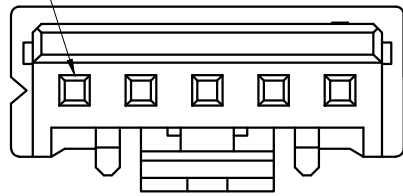

Circuits	Product name	Dimension mm		Circuits	Product name	Dimension mm	
		A	B			A	B
2	DL25018-2Y	2.50	7.30	12	DL25018-12Y	27.50	32.30
3	DL25018-3Y	5.00	9.80	13	DL25018-13Y	30.00	34.80
4	DL25018-4Y	7.50	12.30	14	DL25018-14Y	32.50	37.30
5	DL25018-5Y	10.00	14.80	15	DL25018-15Y	35.00	39.80
6	DL25018-6Y	12.50	17.30	16	DL25018-16Y	37.50	42.30
7	DL25018-7Y	15.00	19.80	17	DL25018-17Y	40.00	44.80
8	DL25018-8Y	17.50	22.30	18	DL25018-18Y	42.50	47.30
9	DL25018-9Y	20.00	24.80	19	DL25018-19Y	45.00	47.30
10	DL25018-10Y	22.50	27.30	20	DL25018-20Y	47.50	52.30
11	DL25018-11Y	25.00	29.80				

GENERAL TOLERANCES (UNLESS SPECIFIED)		ZHE JIANG DELI CONNECTORS CO., LTD	
.X: ± 0.25	X° : ± 3.0°	PRODUCT NAME: <b>DL25018-Y</b>	TITLE: 2.50 mm Pitch Housing
.XX: ± 0.15	.X° : ± 2.0°	DR: Chen Quan Long	DATE: 20/08/01
.XXX: ± 0.01	.XX° : ± 1.0°	DATE: 20/08/01	PART NO:
FINISH:		CHKD: Wu Hui	DATE: 20/08/01
DRAWING NO:		APPD: Ren An De	DATE: 20/08/01
		SCALE: N/A	PAGE: 1/1
		UNITS: mm	REV.: A



REV.	REVISION DESCRIPTION	DATE	APPD

**NORES:**

1. Rated voltage: 250V AC/DC
2. Rated current: 3A AC DC
3. Contact resistance:  $\leq 20 \text{ m}\Omega$
4. Insulation resistance:  $\geq 500 \text{ m}\Omega$
5. Withstand voltage: 1500V AC/minute
6. Ambient temperature:  $-25^{\circ}\text{C} \sim 85^{\circ}\text{C}$
7. Materials: Nylon UL94V-0 (2)
8. Matched RoHS criteria

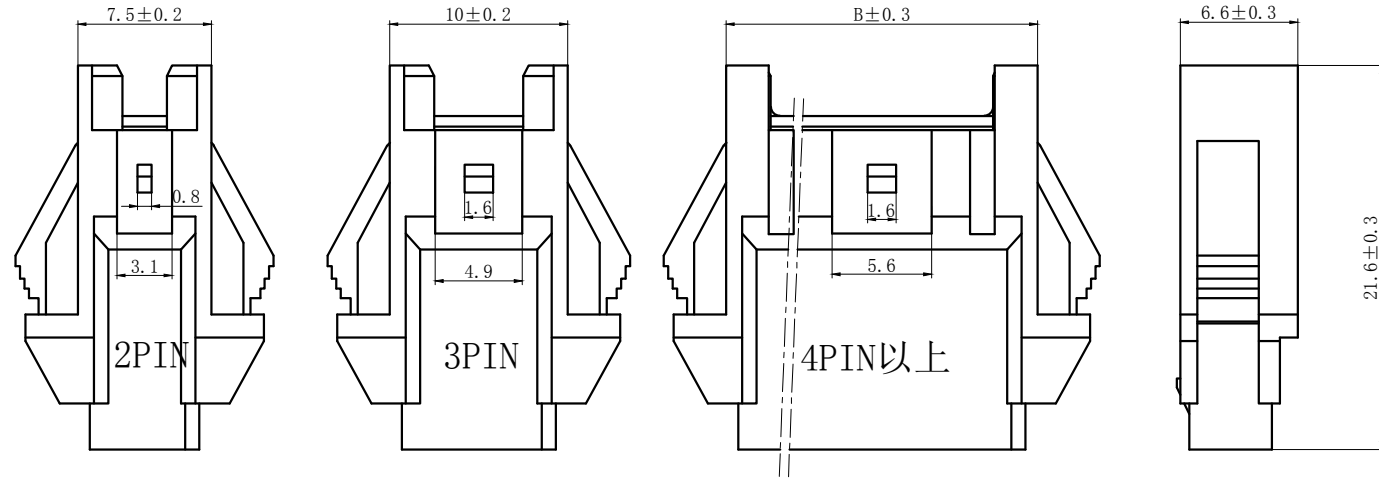

安装尺寸图

Circuits	Product name	Dimension mm					Circuits	Product name	Dimension mm				
		A	B	C	D	E			A	B	C	D	E
2	DL25018-2R	2.50	7.50	5.90	7.90	11.20	10	DL25018-10R	22.50	27.50	25.90	27.90	31.20
3	DL25018-3R	5.00	10.00	8.40	10.40	13.70	11	DL25018-11R	25.00	30.00	28.40	30.40	33.70
4	DL25018-4R	7.50	12.50	10.90	12.90	16.20	12	DL25018-12R	27.50	32.50	30.90	32.90	36.20
5	DL25018-5R	10.00	15.00	13.40	15.40	18.70	13	DL25018-13R	30.00	35.00	33.40	35.40	38.70
6	DL25018-6R	12.50	17.50	15.90	17.90	21.20	14	DL25018-14R	32.50	37.50	35.90	37.90	41.20
7	DL25018-7R	15.00	20.00	18.40	20.40	23.70	15	DL25018-15R	35.00	40.00	38.40	40.40	43.70
8	DL25018-8R	17.50	22.50	20.90	22.90	26.20	-	-	-	-	-	-	-
9	DL25018-9R	20.00	25.00	23.40	25.40	28.70	20	DL25018-20R	47.50	52.50	50.90	52.90	56.20

GENERAL TOLERANCES (UNLESS SPECIFIED)		ZHE JIANG DELI CONNECTORS CO., LTD	
.X: ± 0.25	X°: ± 3.0°	PRODUCT NAME: <b>DL25018-R</b>	TITLE: 2.50 mm Pitch Wire To Wire Housing
.XX: ± 0.15	.X°: ± 2.0°	DR: Yuan Jun Rong	DATE: 21/12/30
.XXX: ± 0.01	.XX°: ± 1.0°	DATE: 21/12/30	PART NO:
FINISH:		CHKD: Wu Hui	DATE: 21/12/30
DRAWING NO:		APPD: Ren An De	DATE: 21/12/30
		SCALE: N/A	PAGE: 1/1
		UNITS: mm	REV.: A

REV.	REVISION DESCRIPTION	DATE	APPD

**NORES:**

1. Rated voltage: 250V AC/DC
2. Rated current: 3A AC/DC
3. Contact resistance:  $\leq 20 \text{ m}\Omega$
4. Insulation resistance:  $\geq 500 \text{ m}\Omega$
5. Withstand voltage: 1500V AC/minute
6. Ambient temperature:  $-25^{\circ}\text{C} \sim 85^{\circ}\text{C}$
7. Materials: Nylon UL94V-0(2)
8. Matched RoHS criteria

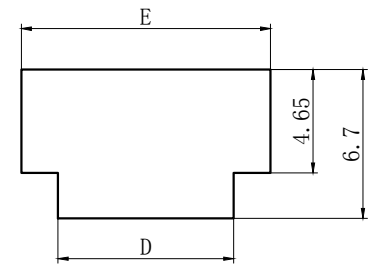
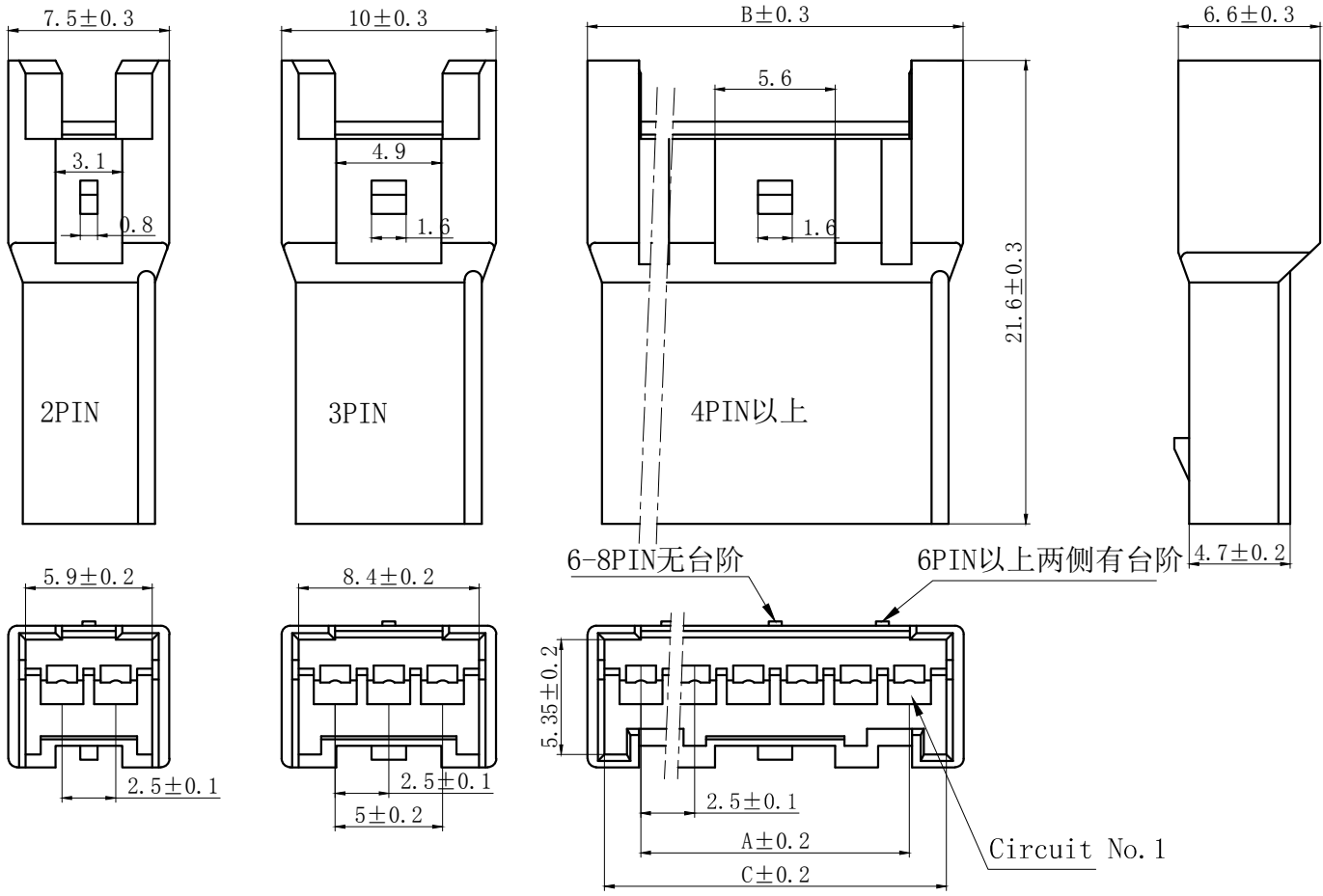

安装尺寸图

Circuits	Product name	Dimension mm					Circuits	Product name	Dimension mm				
		A	B	C	D	E			A	B	C	D	E
2	DL25018-2RF	2.50	7.50	5.90	7.90	11.20	10	DL25018-10RF	22.50	27.50	25.90	27.90	31.20
3	DL25018-3RF	5.00	10.00	8.40	10.40	13.70	11	DL25018-11RF	25.00	30.00	28.40	30.40	33.70
4	DL25018-4RF	7.50	12.50	10.90	12.90	16.20	12	DL25018-12RF	27.50	32.50	30.90	32.90	36.20
5	DL25018-5RF	10.00	15.00	13.40	15.40	18.70	13	DL25018-13RF	30.00	35.00	33.40	35.40	38.70
6	DL25018-6RF	12.50	17.50	15.90	17.90	21.20	14	DL25018-14RF	32.50	37.50	35.90	37.90	41.20
7	DL25018-7RF	15.00	20.00	18.40	20.40	23.70	15	DL25018-15RF	35.00	40.00	38.40	40.40	43.70
8	DL25018-8RF	17.50	22.50	20.90	22.90	26.20	-	-	-	-	-	-	-
9	DL25018-9RF	20.00	25.00	23.40	25.40	28.70	20	DL25018-20RF	47.50	52.50	50.90	52.90	56.20

GENERAL TOLERANCES (UNLESS SPECIFIED)		ZHE JIANG DELI CONNECTORS CO., LTD	
.X: $\pm 0.25$	X°: $\pm 3.0^{\circ}$	PRODUCT NAME: <b>DL25018-RF</b>	TITLE: 2.50 mm Pitch Wire To Wire Housing
.XX: $\pm 0.15$	.X°: $\pm 2.0^{\circ}$	DR: Yuan Jun Rong	DATE: 21/12/30
.XXX: $\pm 0.01$	.XX°: $\pm 1.0^{\circ}$	DATE: 21/12/30	PART NO:
FINISH:		CHKD: Wu Hui	DATE: 21/12/30
DRAWING NO:		APPD: Ren An De	DATE: 21/12/30
		SCALE: N/A	PAGE: 1/1
		UNITS: mm	REV.: A

REV.	REVISION DESCRIPTION	DATE	APPD



**NOTES**  
 Available in 02 through 20 Circuits.  
 Match with DL25018-Y series housing  
 Material : Nylon UL94V-0(2).

Circuits	Product name	Dimension mm		Circuits	Product name	Dimension mm	
		A	B			A	B
2	DL25018-2S	2.50	8.9	10	DL25018-10S	22.50	28.9
3	DL25018-3S	5.00	11.4	11	DL25018-11S	25.00	31.4
4	DL25018-4S	7.50	13.9	12	DL25018-12S	27.50	33.9
5	DL25018-5S	10.00	16.4	13	DL25018-13S	30.00	36.4
6	DL25018-6S	12.50	18.9	14	DL25018-14S	32.50	38.9
7	DL25018-7S	15.00	21.4	15	DL25018-15S	35.00	41.4
8	DL25018-8S	17.50	23.9	-	-	-	-
9	DL25018-9S	20.00	26.4	20	DL25018-20S	47.50	43.9

GENERAL TOLERANCES (UNLESS SPECIFIED)		ZHE JIANG DELI CONNECTORS CO., LTD	
.X: ± 0.25	X°: ± 3.0°	PRODUCT NAME: <b>DL25018-S</b>	TITLE: 2.50 mm Pitch Housing
.XX: ± 0.15	.X°: ± 2.0°	DR: Yuan Jun Rong	DATE: 20/08/01
.XXX: ± 0.01	.XX°: ± 1.0°	DATE: 20/08/01	PART NO:
FINISH:		CHKD: Wu Hui	SCALE: N/A
DRAWING NO:		APPD: Ren An De	DATE: 20/08/01
			PAGE: 1/1
			UNITS: mm
			REV.: A

REV.	REVISION DESCRIPTION	DATE	APPD

6-8Pin



NOTES

Available in 02 through 20 Circuits.  
Mates with DL25018-R/DL25034-RK/  
DL25035/DL25045 Series Housing.  
Material : Nylon UL94-V0(2).  
Green Material RoHS Compliant.

1-5Pin

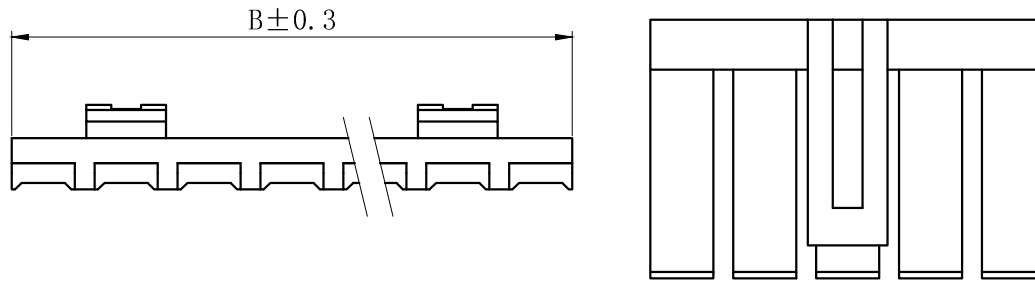

9-20Pin

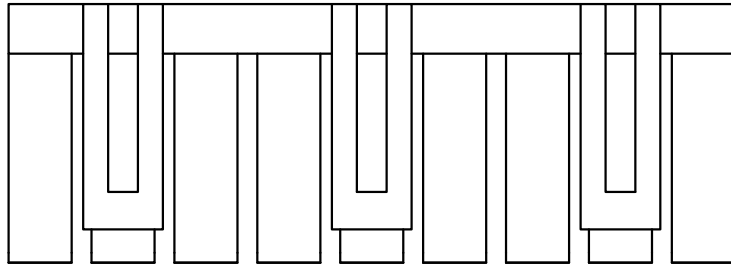

Circuits	Product name	Dimension mm		Circuits	Product name	Dimension mm	
		A	B			A	B
2	DL25018-2RS	2.50	4.4	10	DL25018-10RS	22.50	24.4
3	DL25018-3RS	5.00	6.9	11	DL25018-11RS	25.00	26.9
4	DL25018-4RS	7.50	9.4	12	DL25018-12RS	27.50	29.4
5	DL25018-5RS	10.00	11.9	13	DL25018-13RS	30.00	31.9
6	DL25018-6RS	12.50	14.4	14	DL25018-14RS	32.50	34.4
7	DL25018-7RS	15.00	16.9	15	DL25018-15RS	35.00	36.9
8	DL25018-8RS	17.50	19.4	-	-	-	-
9	DL25018-9RS	20.00	21.9	20	DL25018-RS	47.50	49.4

GENERAL TOLERANCES (UNLESS SPECIFIED)		ZHE JIANG DELI CONNECTORS CO., LTD			
.X: ± 0.25	X°: ± 3.0°	PRODUCT NAME: DL25018-RS		TITLE: 2.5 mm Pitch Wire To Wire	
.XX: ± 0.15	.X°: ± 2.0°	DR: Chen Quan Long	DATE: 21/05/01	PART NO:	
.XXX: ± 0.01	.XX°: ± 1.0°	CHKD: Wu Hui	DATE: 21/05/01	SCALE: N/A	PAGE: 1/1
DRAWING NO:		APPD: Ren An De	DATE: 21/05/01	UNITS: mm	REV.: A

REV.	REVISION DESCRIPTION	DATE	APPD



技术特性/Specifications:

额定电压Rated voltage :250V AC.DC.  
 额定电流Rated current :3A AC.DC.  
 接触电阻Contact resistance:20MΩ MAX  
 绝缘电阻Insulation resistance: 1000 MΩ MIN  
 耐压Withstand voltage:1000V AC/minute  
 环境温度Ambient temperature: -40℃~+105℃  
 适用线规 Wire range: AWG#28~#20

材料/Materials:

端子Terminal: 磷青铜Phosphor bronze ,  
 镀锡Tin plated



SECTION A-A



SECTION B-B



SECTION C-C

Product name	Dimension (mm)				Applicable wire	Insulation O. D. (mm)
	A1	B1	A2	B2		
DL25018-T	2.9	3.0	1.9	1.6	AWG#28-22	1.9mm Max
DL25018-T-G	2.9	3.0	2.3	2.1	AWG#24-20	1.9mm Max

GENERAL TOLERANCES (UNLESS SPECIFIED)				ZHE JIANG DELI CONNECTORS CO., LTD			
.X: ± 0.25	X°: ± 3.0°	PRODUCT NAME: DL25018-T		TITLE: 2.50 mm Pitch Crimp Terminal			
.XX: ± 0.15	.X°: ± 2.0°	DR: Yuan Jun Rong		DATE:21/12/30		PART NO:	
.XXX: ± 0.01	.XX°: ± 1.0°	FINISH:		CHKD: Wu Hui		DATE:21/12/30	
DRAWING NO:		APPD: Ren An De		DATE:21/12/30		SCALE: N/A	PAGE: 1/1
				UNITS: mm	REV.: A		

REV.	REVISION DESCRIPTION	DATE	APPD

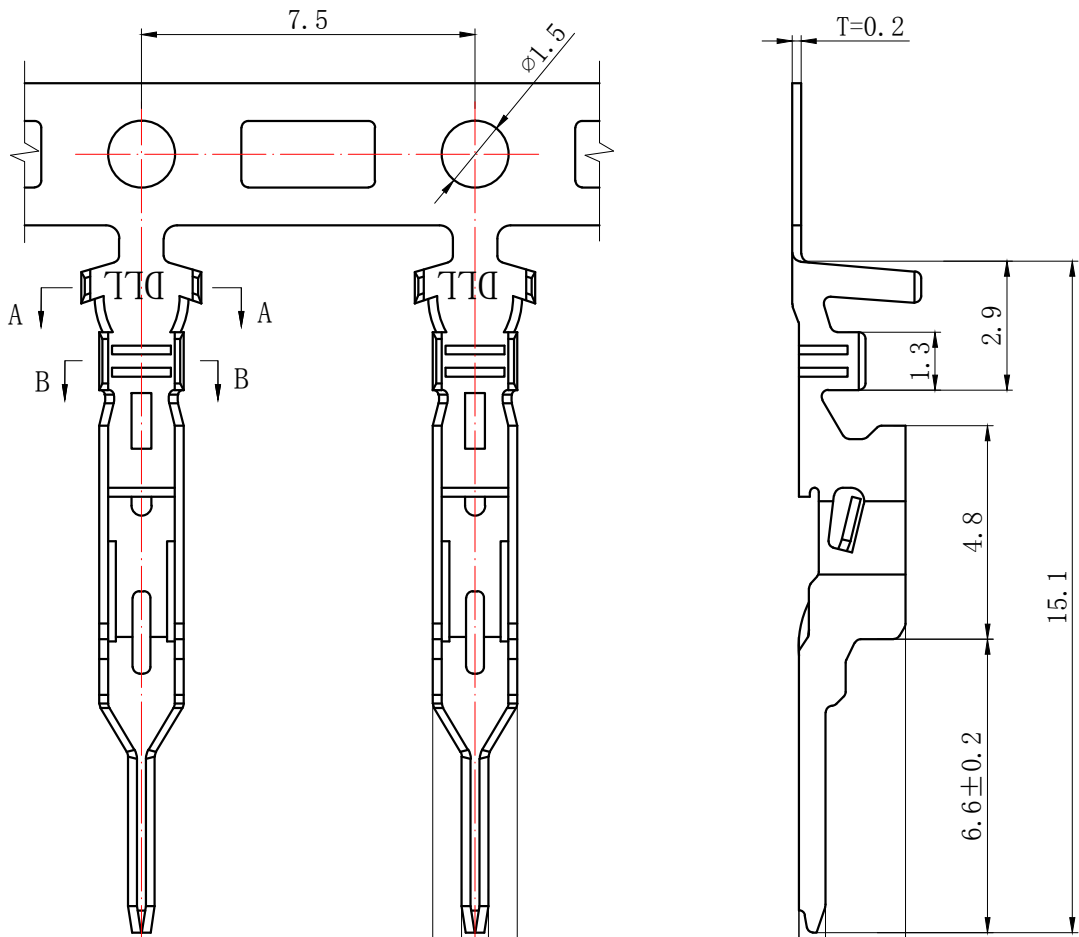

技术特性/Specifications:  
 额定电压Rated voltage :250V AC.DC.  
 额定电流Rated current :3A AC.DC.  
 接触电阻Contact resistance:20MΩ MAX  
 绝缘电阻Insulation resistance: 500 MΩ MIN  
 耐压Withstand voltage:1500V AC/minute  
 环境温度Ambient temperature: -40℃~+105℃  
 适用线规 Wire range: AWG#28~#20  
 材料/Materials:  
 端子Terminal: 磷青铜Phosphor bronze ,  
 镀锡Tin plated



SECTION A-A



SECTION B-B

Product name	Dimension (mm)				Applicable wire	Insulation O.D. (mm)
	A1	B1	A2	B2		
DL25018-RT	2.9	2.9	1.9	1.5	AWG#28-22	1.9mm Max
DL25018-RT-G	2.9	2.9	2.2	2.1	AWG#24-20	1.9mm Max

GENERAL TOLERANCES (UNLESS SPECIFIED)		ZHE JIANG DELI CONNECTORS CO., LTD	
.X: ± 0.25	X°: ± 3.0°	PRODUCT NAME:	TITLE:
.XX: ± 0.15	.X°: ± 2.0°	DL25018-RT	2.50 mm Pitch Wire To Wire Terminal
.XXX: ± 0.01	.XX°: ± 1.0°	DR:Yuan Jun Rong	DATE:21/12/30
FINISH:		CHKD:Wu Hui	DATE:21/12/30
DRAWING NO:		APPD:Ren An De	DATE:21/12/30
		PART NO:	SCALE: N/A
		UNITS: mm	PAGE: 1/1
		REV.: A	

REV.	REVISION DESCRIPTION	DATE	APPD

### NOTES

Available in 02 through 20 Circuits.  
 Mates with DL25018-Y Series Housing.  
 Material : Nylon UL94V-0.  
 0.60mm Square Pin.  
 Pin Material : Brass / Tin-Plated.

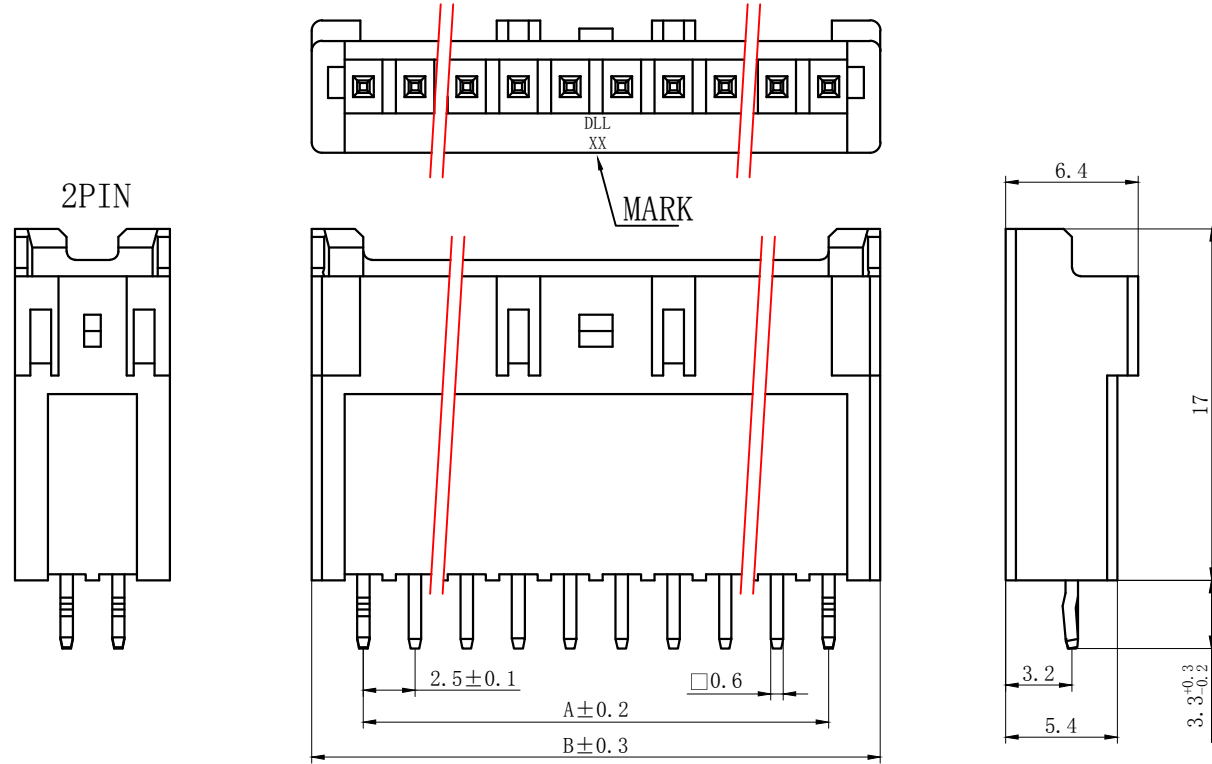

Circuits	Product name	Dimension mm			Circuits	Product name	Dimension mm		
		A	B	C			A	B	C
2	XAH-2A	2.50	7.50	5.90	10	XAH-10A	22.50	27.50	25.90
3	XAH-3A	5.00	10.00	8.40	11	XAH-11A	25.00	30.00	28.40
4	XAH-4A	7.50	12.50	10.90	12	XAH-12A	27.50	32.50	30.90
5	XAH-5A	10.00	15.00	13.40	13	XAH-13A	30.00	35.00	33.40
6	XAH-6A	12.50	17.50	15.90	14	XAH-14A	32.50	37.50	35.90
7	XAH-7A	15.00	20.00	18.40	15	XAH-15A	35.00	40.00	38.40
8	XAH-8A	17.50	22.50	20.90	-	-	-	-	-
9	XAH-9A	20.00	25.00	23.40	20	XAH-20A	47.50	52.50	50.90

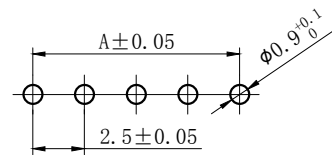

P. C. B LATOUT

#### GENERAL TOLERANCES (UNLESS SPECIFIED)

.X: ± 0.25	X° : ± 3.0°
.XX: ± 0.15	.X° : ± 2.0°
.XXX: ± 0.01	.XX° : ± 1.0°
FINISH:	
DRAWING NO:	

#### ZHE JIANG DELI CONNECTORS CO., LTD

PRODUCT NAME: <b>DL25035 (XAH) -A</b>		TITLE: 2.50 mm Pitch Wire To Board Wafer	
DR: Yuan Jun Rong	DATE: 19/07/20	PART NO:	
CHKD: Wu Hui	DATE: 19/07/20	SCALE: N/A	PAGE: 1/1
APPD: Ren An De	DATE: 19/07/20	UNITS: mm	REV.: A

REV.	REVISION DESCRIPTION	DATE	APPD

### NOTES

Available in 02 through 20 Circuits.  
 Mates with DL25018-Y Series Housing.  
 Material : Nylon UL94V-0.  
 0.60mm Square Pin.  
 Pin Material : Brass / Tin-Plated.

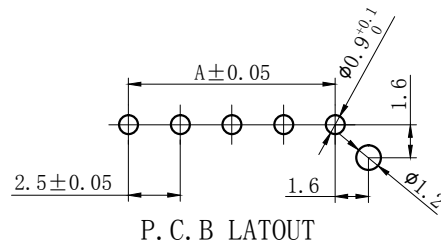
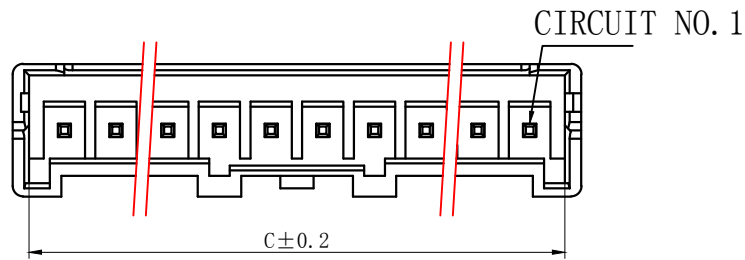
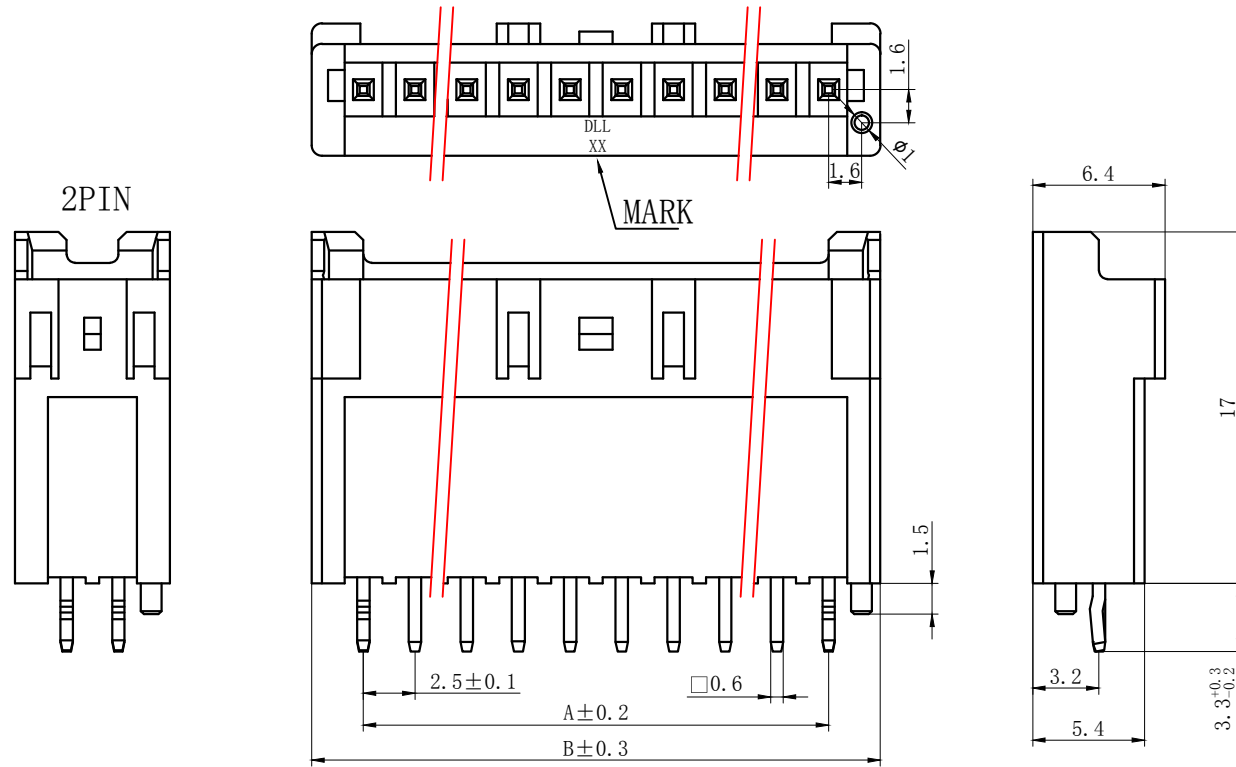

Circuits	Product name	Dimension mm			Circuits	Product name	Dimension mm		
		A	B	C			A	B	C
2	XAH-2AS	2.50	7.50	5.90	10	XAH-10AS	22.50	27.50	25.90
3	XAH-3AS	5.00	10.00	8.40	11	XAH-11AS	25.00	30.00	28.40
4	XAH-4AS	7.50	12.50	10.90	12	XAH-12AS	27.50	32.50	30.90
5	XAH-5AS	10.00	15.00	13.40	13	XAH-13AS	30.00	35.00	33.40
6	XAH-6AS	12.50	17.50	15.90	14	XAH-14AS	32.50	37.50	35.90
7	XAH-7AS	15.00	20.00	18.40	15	XAH-15AS	35.00	40.00	38.40
8	XAH-8AS	17.50	22.50	20.90	-	-	-	-	-
9	XAH-9AS	20.00	25.00	23.40	20	XAH-20AS	47.50	52.50	50.90

GENERAL TOLERANCES (UNLESS SPECIFIED)		ZHE JIANG DELI CONNECTORS CO., LTD	
.X: ± 0.25	X°: ± 3.0°	PRODUCT NAME: DL25035 (XAH)-AS	TITLE: 2.50 mm Pitch Wire To Board Wafer
.XX: ± 0.15	.X°: ± 2.0°	DR: Yuan Jun Rong	DATE: 19/07/20
.XXX: ± 0.01	.XX°: ± 1.0°	CHKD: Wu Hui	DATE: 19/07/20
FINISH:		APPD: Ren An De	DATE: 19/07/20
DRAWING NO:			
		SCALE: N/A	PAGE: 1/1
		UNITS: mm	REV.: A



REV.	REVISION DESCRIPTION	DATE	APPD

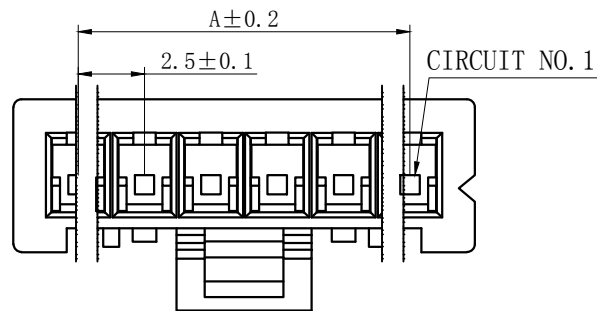
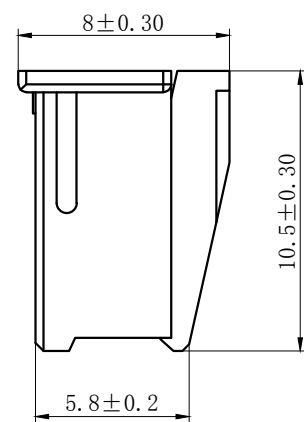
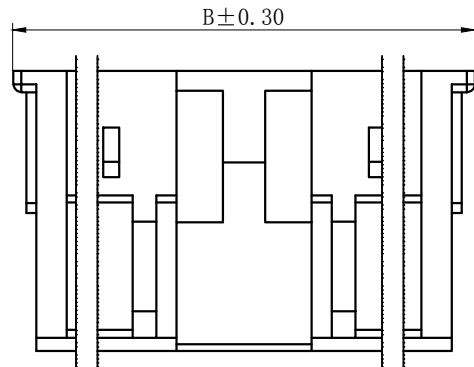
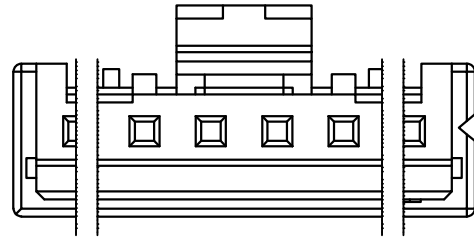

### NOTES

Available in 02 through 20 Circuits.  
 Match with DL25018 or DL25035 series housing  
 Material : Nylon UL94V-0(2).  
 Accepts DL25035-T Crimp Terminal.

Circuits	Product name	Dimension mm		Circuits	Product name	Dimension mm	
		A	B			A	B
2	XAH-2Y	2.50	7.30	12	XAH-12Y	27.50	32.30
3	XAH-3Y	5.00	9.80	13	XAH-13Y	30.00	34.80
4	XAH-4Y	7.50	12.30	14	XAH-14Y	32.50	37.30
5	XAH-5Y	10.00	14.80	15	XAH-15Y	35.00	39.80
6	XAH-6Y	12.50	17.30	16	XAH-16Y	37.50	42.30
7	XAH-7Y	15.00	19.80	17	XAH-17Y	40.00	44.80
8	XAH-8Y	17.50	22.30	18	XAH-18Y	42.50	47.30
9	XAH-9Y	20.00	24.80	19	XAH-19Y	45.00	47.30
10	XAH-10Y	22.50	27.30	20	XAH-20Y	47.50	52.30
11	XAH-11Y	25.00	29.80				

GENERAL TOLERANCES (UNLESS SPECIFIED)		ZHE JIANG DELI CONNECTORS CO ., LTD	
.X: ± 0.25	X° : ± 3.0°	PRODUCT NAME: <b>DL25035 (XAH) -Y</b>	TITLE: 2.50 mm Pitch Housing
.XX: ± 0.15	.X° : ± 2.0°	DR:Chen Quan Long	DATE:20/08/01
.XXX: ± 0.01	.XX° : ± 1.0°	DATE:20/08/01	PART NO:
FINISH:		CHKD: Wu Hui	DATE:20/08/01
DRAWING NO:		APPD:Ren An De	DATE:20/08/01
		SCALE: N/A	PAGE: 1/1
		UNITS: mm	REV.: A

## X-ON Electronics

Largest Supplier of Electrical and Electronic Components

*Click to view similar products for [Headers & Wire Housings](#) category:*

*Click to view products by [DLL manufacturer](#):*

Other Similar products are found below :

[0015917161](#) [0022155065](#) [57102-F02-18ULF](#) [58102-G61-06LF](#) [582553-1](#) [01.001.5753.1](#) [0050291907](#) [02.125.8002.8](#) [609-3404](#) [61062-3](#)  
[CSU011177004](#) [622-0430](#) [622-3653LF](#) [63453-116](#) [636-1030](#) [636-1427](#) [636-3427](#) [636-4007](#) [641938-9](#) [65495-038](#) [65692-001LF](#) [65781-018](#)  
[65781-047](#) [65817-010LF](#) [65817-015LF](#) [67095-007LF](#) [67601157](#) [68631-112](#) [68645-018](#) [699319-000](#) [70.362.1628.0](#) [70-4210](#) [70-4226B](#) [70-](#)  
[4853B](#) [71.350.2428.0](#) [733-134](#) [733-162](#) [MHR-64-VUAL](#) [80.063.4001.1](#) [800-90-001-10-001000](#) [801-43-002-10-013000](#) [801-43-006-10-](#)  
[002000](#) [803-43-024-10-001000](#) [803-93-012-10-001000](#) [8-1437020-4](#) [819-22-004-30-001101](#) [820-22-006-30-001101](#) [820-22-008-30-001101](#)  
[821-22-002-10-001101](#) [821-22-003-10-002101](#)