

技术特性/Specifications:

额定电压 Rated voltage: 250V AC, DC
额定电流 Rated current: 3A AC, DC
接触电阻 Contact resistance: 20mΩ max
绝缘电阻 Insulation resistance: 1000MΩ min
耐压 Withstand voltage: 1000V AC/minute
环境温度 Ambient temperature: -40℃~+105℃
适用线规 Wire range: AWG#32~#28

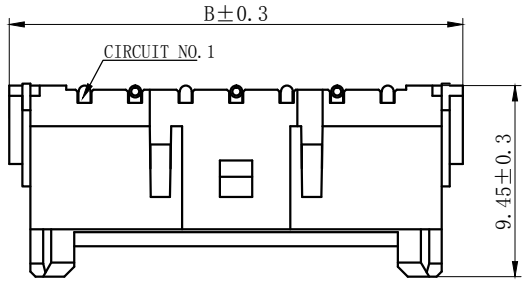

| REV. | REVISION DESCRIPTION | DATE | APPD |
|------|----------------------|------|------|
| | | | |



SECTION A-A



NORES:

- 1、Rated voltage: 250V AC DC
- 2、Rated current: 3A AC DC
- 3、Contact resistance: $\leq 20 \text{ m}\Omega$
- 4、Insulation resistance: $\geq 1000 \text{ m}\Omega$
- 5、Withstand voltage: 1000V AC/minute
- 6、Ambient temprature: $-25^{\circ}\text{C} \sim 85^{\circ}\text{C}$
- 7、Materials:LCP UL94V-0
- 8、Matched RoHS criteria

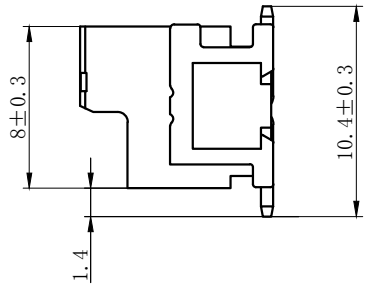
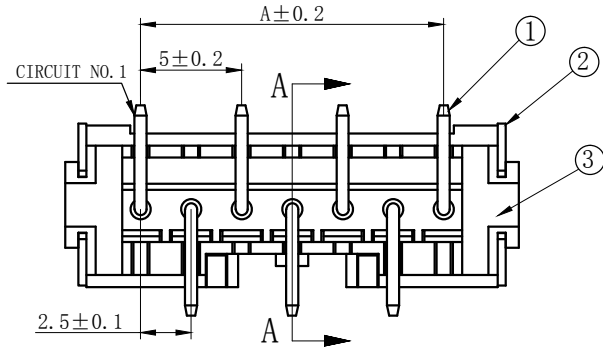

| 序号 | 图号 | 名称 | 材料 | 数量 | 附件 |
|----|----|-----|-----|----|---------|
| 3 | ③ | 基座 | LCP | 1 | UL94-V0 |
| 2 | ② | 焊片 | 黄铜 | 2 | 镀锡 |
| 1 | ① | 接触件 | 黄铜 | N* | 镀锡 |

| Circuits | Product name | Dimension mm | | Circuits | Product name | Dimension mm | |
|----------|--------------|--------------|-------|----------|--------------|--------------|-------|
| | | A | B | | | A | B |
| 2 | DL25018-2AB | 2.50 | 10.00 | 10 | DL25018-10AB | 22.50 | 30.00 |
| 3 | DL25018-3AB | 5.00 | 12.50 | 11 | DL25018-11AB | 25.00 | 32.50 |
| 4 | DL25018-4AB | 7.50 | 15.00 | 12 | DL25018-12AB | 27.50 | 35.00 |
| 5 | DL25018-5AB | 10.00 | 17.50 | 13 | DL25018-13AB | 30.00 | 37.50 |
| 6 | DL25018-6AB | 12.50 | 20.00 | 14 | DL25018-14AB | 32.50 | 40.00 |
| 7 | DL25018-7AB | 15.00 | 22.50 | 15 | DL25018-15AB | 35.00 | 42.50 |
| 8 | DL25018-8AB | 17.50 | 25.00 | - | - | - | - |
| 9 | DL25018-9AB | 20.00 | 27.50 | 20 | DL25018-20AB | 47.50 | 55.00 |

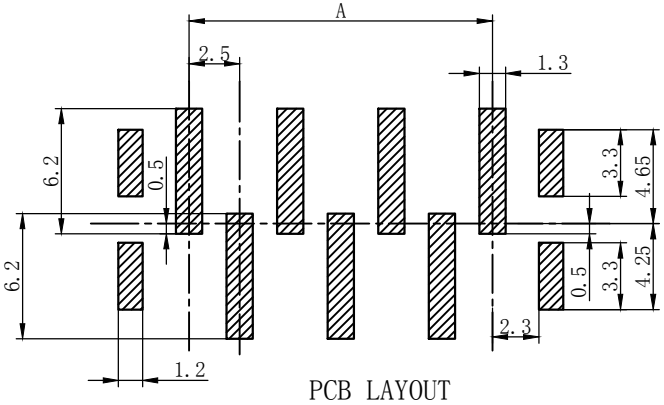

| GENERAL TOLERANCES (UNLESS SPECIFIED) | | ZHE JIANG DELI CONNECTORS CO., LTD | |
|---------------------------------------|--------------|------------------------------------|--|
| .X: ± 0.25 | X°: ± 3.0° | PRODUCT NAME: DL25018-AB | TITLE: 2.50 mm Pitch Wire To Board SMT Wafer |
| .XX: ± 0.15 | .X°: ± 2.0° | DR:Chen Quan Long | DATE:18/03/03 |
| .XXX: ± 0.01 | .XX°: ± 1.0° | CHKD:Wu Hui | DATE:18/03/03 |
| FINISH: _____ | | APPD:Ren An De | DATE:18/03/03 |
| DRAWING NO: | | | PART NO: |
| | | | SCALE: N/A |
| | | | PAGE: 1/1 |
| | | | UNITS: mm |
| | | | REV.: B |

| REV. | REVISION DESCRIPTION | DATE | APPD |
|------|----------------------|------|------|
| | | | |

NORES:

- 1、Rated voltage: 250V AC DC
- 2、Rated current: 3A AC DC
- 3、Contact resistance: $\leq 20 \text{ m}\Omega$
- 4、Insulation resistance: $\geq 1000 \text{ m}\Omega$
- 5、Withstand voltage: 1000V AC/minute
- 6、Ambient temprature: $-25^{\circ}\text{C} \sim 85^{\circ}\text{C}$
- 7、Materials: LCP UL94V-0
- 8、Matched RoHS criteria

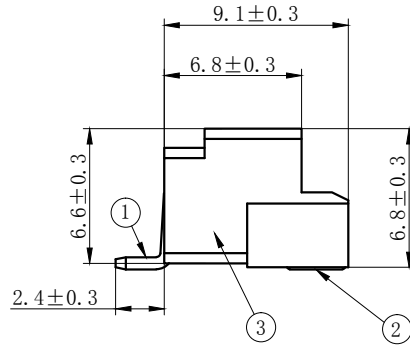
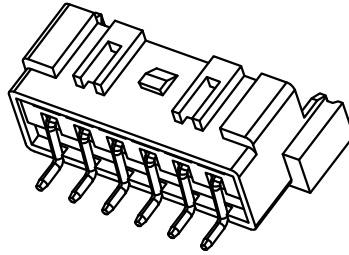
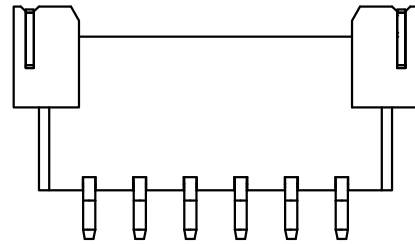

| | | | | | |
|----|----|-----|-----|----|---------|
| 3 | ③ | 基座 | LCP | 1 | UL94-V0 |
| 2 | ② | 焊片 | 黄铜 | 2 | 镀锡 |
| 1 | ① | 接触件 | 黄铜 | N* | 镀锡 |
| 序号 | 图号 | 名称 | 材料 | 数量 | 附件 |

Circuit No.1



| Circuits | Product name | Dimension mm | | Circuits | Product name | Dimension mm | |
|----------|--------------|--------------|-------|----------|---------------|--------------|-------|
| | | A | B | | | A | B |
| 2 | DL25018-2AWB | 2.50 | 10.00 | 10 | DL25018-10AWB | 22.50 | 30.00 |
| 3 | DL25018-3AWB | 5.00 | 12.50 | 11 | DL25018-11AWB | 25.00 | 32.50 |
| 4 | DL25018-4AWB | 7.50 | 15.00 | 12 | DL25018-12AWB | 27.50 | 35.00 |
| 5 | DL25018-5AWB | 10.00 | 17.50 | 13 | DL25018-13AWB | 30.00 | 37.50 |
| 6 | DL25018-6AWB | 12.50 | 20.00 | 14 | DL25018-14AWB | 32.50 | 40.00 |
| 7 | DL25018-7AWB | 15.00 | 22.50 | 15 | DL25018-15AWB | 35.00 | 42.50 |
| 8 | DL25018-8AWB | 17.50 | 25.00 | - | - | - | - |
| 9 | DL25018-9AWB | 20.00 | 27.50 | 20 | DL25018-20AWB | 47.50 | 55.00 |

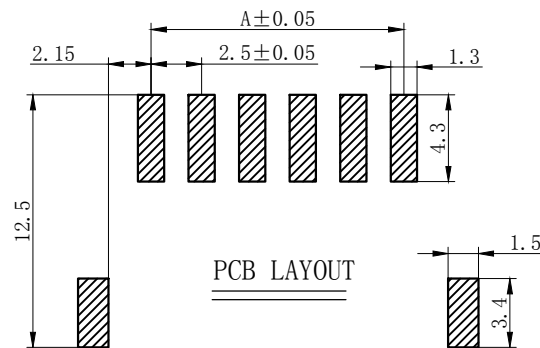

| GENERAL TOLERANCES (UNLESS SPECIFIED) | | ZHE JIANG DELI CONNECTORS CO., LTD | |
|---------------------------------------|--------------|-------------------------------------|--|
| .X: ± 0.25 | X°: ± 3.0° | PRODUCT NAME: DL25018-AWB | TITLE: 2.50 mm Pitch Wire To Board SMT Wafer |
| .XX: ± 0.15 | .X°: ± 2.0° | DR: Chen Quan Long | DATE: 23/08/01 |
| .XXX: ± 0.01 | .XX°: ± 1.0° | CHKD: Wu Hui | DATE: 23/08/01 |
| FINISH: | | APPD: Ren An De | DATE: 23/08/01 |
| DRAWING NO: | | SCALE: N/A | PAGE: 1/1 |
| | | UNITS: mm | REV.: B |

| | | | |
|------|----------------------|------|------|
| REV. | REVISION DESCRIPTION | DATE | APPD |
| | | | |

NOTES

Available in 02 through 20 Circuits.
 Mates with DL25018-Y Series Housing.
 Material : Nylon UL94V-0(2).
 0.6mm round Pin.
 Pin Material : Brass / Tin-Plated.

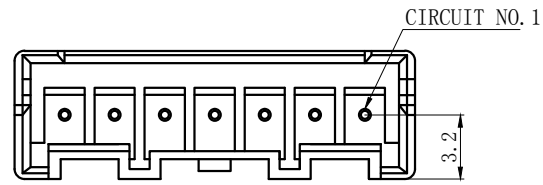

PCB LAYOUT

| Circuits | Product name | Dimension mm | | Circuits | Product name | Dimension mm | |
|----------|--------------|--------------|-------|----------|--------------|--------------|-------|
| | | A | B | | | A | B |
| 2 | DL25018-2A | 2.50 | 7.50 | 10 | DL25018-10A | 22.50 | 27.50 |
| 3 | DL25018-3A | 5.00 | 10.00 | 11 | DL25018-11A | 25.00 | 30.00 |
| 4 | DL25018-4A | 7.50 | 12.50 | 12 | DL25018-12A | 27.50 | 32.50 |
| 5 | DL25018-5A | 10.00 | 15.00 | 13 | DL25018-13A | 30.00 | 35.00 |
| 6 | DL25018-6A | 12.50 | 17.50 | 14 | DL25018-14A | 32.50 | 37.50 |
| 7 | DL25018-7A | 15.00 | 20.00 | 15 | DL25018-15A | 35.00 | 40.00 |
| 8 | DL25018-8A | 17.50 | 22.50 | - | - | - | - |
| 9 | DL25018-9A | 20.00 | 25.00 | 20 | DL25018-20A | 47.50 | 52.50 |

| | | | |
|--|--------------|------------------------------------|---|
| GENERAL TOLERANCES (UNLESS SPECIFIED) | | ZHE JIANG DELI CONNECTORS CO., LTD | |
| .X: ± 0.25 | X°: ± 3.0° | PRODUCT NAME: DL25018-A | TITLE: 2.50 mm Pitch Wire To Board Wafer |
| .XX: ± 0.15 | .X°: ± 2.0° | DR: Chen Quan Long | DATE: 20/08/01 |
| .XXX: ± 0.01 | .XX°: ± 1.0° | CHKD: Wu Hui | DATE: 20/08/01 |
| FINISH: | | APPD: Ren An De | DATE: 20/08/01 |
| DRAWING NO: | | | |
| | | SCALE: N/A | PAGE: 1/1 |
| | | UNITS: mm | REV.: A |

| REV. | REVISION DESCRIPTION | DATE | APPD |
|------|----------------------|------|------|
| | | | |

NOTES

Available in 02 through 20 Circuits.
 Mates with DL25018-Y Series Housing.
 Material : Nylon UL94V-0(2).
 0.6mm round Pin.
 Pin Material : Brass / Tin-Plated.

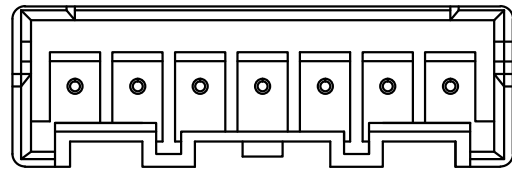

P. C. B LATOUT

| Circuits | Product name | Dimension mm | | Circuits | Product name | Dimension mm | |
|----------|--------------|--------------|-------|----------|--------------|--------------|-------|
| | | A | B | | | A | B |
| 2 | DL25018-2AS | 2.50 | 7.50 | 10 | DL25018-10AS | 22.50 | 27.50 |
| 3 | DL25018-3AS | 5.00 | 10.00 | 11 | DL25018-11AS | 25.00 | 30.00 |
| 4 | DL25018-4AS | 7.50 | 12.50 | 12 | DL25018-12AS | 27.50 | 32.50 |
| 5 | DL25018-5AS | 10.00 | 15.00 | 13 | DL25018-13AS | 30.00 | 35.00 |
| 6 | DL25018-6AS | 12.50 | 17.50 | 14 | DL25018-14AS | 32.50 | 37.50 |
| 7 | DL25018-7AS | 15.00 | 20.00 | 15 | DL25018-15AS | 35.00 | 40.00 |
| 8 | DL25018-8AS | 17.50 | 22.50 | - | - | - | - |
| 9 | DL25018-9AS | 20.00 | 25.00 | 20 | DL25018-20AS | 47.50 | 52.50 |

| GENERAL TOLERANCES (UNLESS SPECIFIED) | | ZHE JIANG DELI CONNECTORS CO., LTD | |
|---------------------------------------|---------------|--|---------------|
| .X: ± 0.25 | .X°: ± 3.0° | PRODUCT NAME: DL25018-AS | |
| .XX: ± 0.15 | .XX°: ± 2.0° | TITLE: 2.50 mm Pitch Wire To Board Wafer | |
| .XXX: ± 0.01 | .XXX°: ± 1.0° | DR: Ke Xian Qiang | DATE:09/08/01 |
| FINISH: | | CHKD: Liu Bing | DATE:09/08/01 |
| DRAWING NO: | | APPD:Ren An De | DATE:09/08/01 |
| | | PART NO: | |
| | | SCALE: N/A | PAGE: 1/1 |
| | | UNITS: mm | REV.: A |

| REV. | REVISION DESCRIPTION | DATE | APPD |
|------|----------------------|------|------|
| | | | |

NOTES

Available in 02 through 20 Circuits.
 Mates with DL25018-Y Series Housing.
 Material : Nylon UL94V-0(2).
 0.6mm round Pin.
 Pin Material : Brass / Tin-Plated

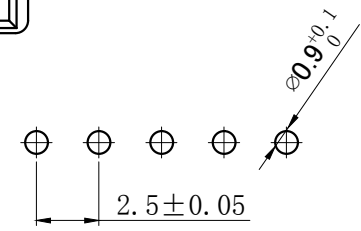
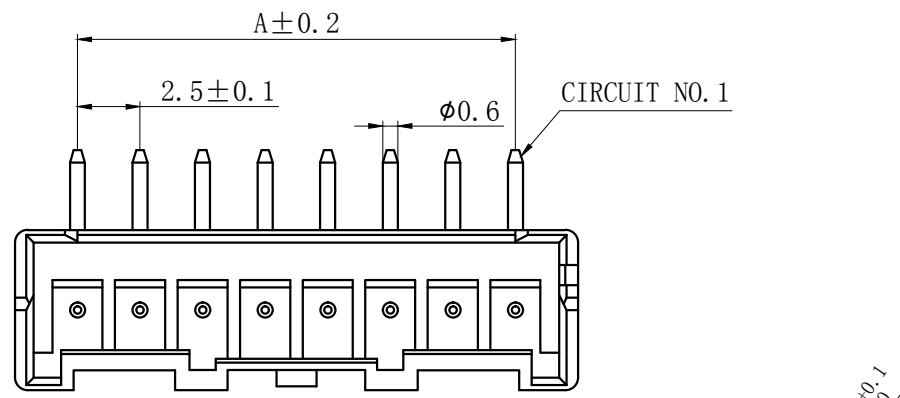

PCB LAYOUT

| Circuits | Product name | Dimension mm | | Circuits | Product name | Dimension mm | |
|----------|--------------|--------------|-------|----------|---------------|--------------|-------|
| | | A | B | | | A | B |
| 2 | DL25018-2AWD | 2.50 | 7.50 | 10 | DL25018-10AWD | 22.50 | 27.50 |
| 3 | DL25018-3AWD | 5.00 | 10.00 | 11 | DL25018-11AWD | 25.00 | 30.00 |
| 4 | DL25018-4AWD | 7.50 | 12.50 | 12 | DL25018-12AWD | 27.50 | 32.50 |
| 5 | DL25018-5AWD | 10.00 | 15.00 | 13 | DL25018-13AWD | 30.00 | 35.00 |
| 6 | DL25018-6AWD | 12.50 | 17.50 | 14 | DL25018-14AWD | 32.50 | 37.50 |
| 7 | DL25018-7AWD | 15.00 | 20.00 | 15 | DL25018-15AWD | 35.00 | 40.00 |
| 8 | DL25018-8AWD | 17.50 | 22.50 | - | - | - | - |
| 9 | DL25018-9AWD | 20.00 | 25.00 | 20 | DL25018-20AWD | 47.50 | 52.50 |

| GENERAL TOLERANCES (UNLESS SPECIFIED) | | | | ZHE JIANG DELI CONNECTORS CO., LTD | | | |
|---------------------------------------|--------------|-------------------------------------|----------------|--|-----------|--|--|
| .X: ± 0.25 | X°: ± 3.0° | PRODUCT NAME: DL25018-AWD | | TITLE: 2.50 mm Pitch Wire To Board Wafer | | | |
| .XX: ± 0.15 | .X°: ± 2.0° | DR: Chen Quan Long | DATE: 20/08/01 | PART NO: | | | |
| .XXX: ± 0.01 | .XX°: ± 1.0° | CHKD: Wu Hui | DATE: 20/08/01 | SCALE: N/A | PAGE: 1/1 | | |
| DRAWING NO: | | APPD: Ren An De | DATE: 20/08/01 | UNITS: mm | REV.: A | | |

| REV. | REVISION DESCRIPTION | DATE | APPD |
|------|----------------------|------|------|
| | | | |

NOTES

Available in 02 through 20 Circuits.
 Mates with DL25018-Y Series Housing.
 Material : Nylon UL94V-0(2).
 0.6mm round Pin.
 Pin Material : Brass / Tin-Plated.

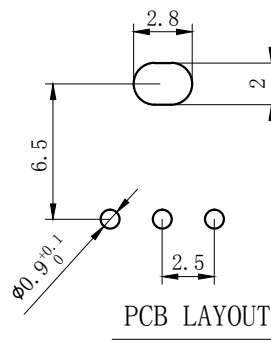
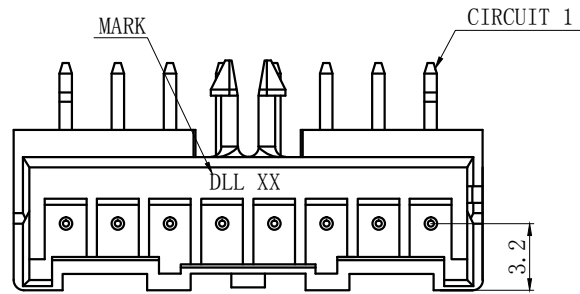
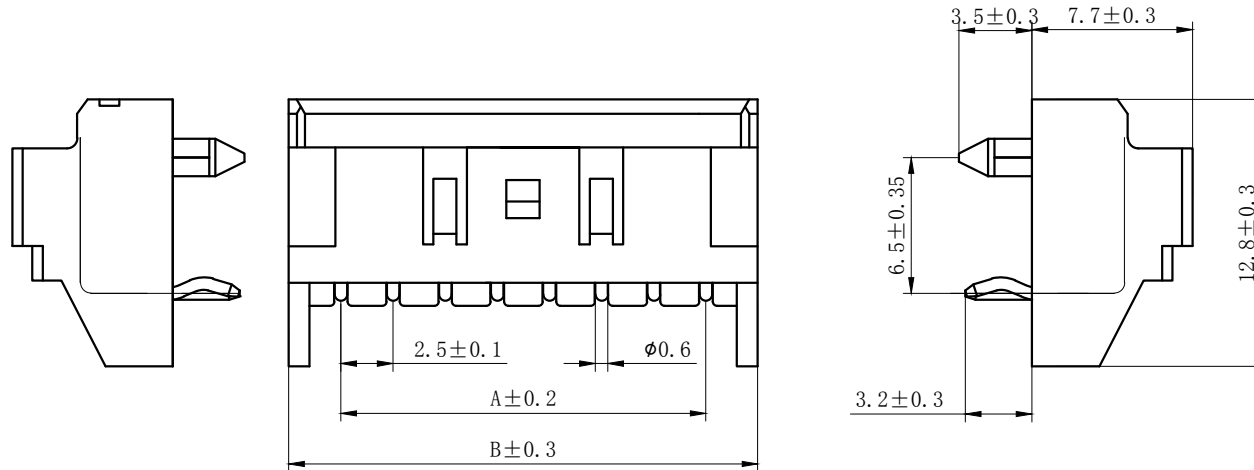

| Circuits | Product name | Dimension mm | | Circuits | Product name | Dimension mm | |
|----------|----------------|--------------|-------|----------|-----------------|--------------|-------|
| | | A | B | | | A | B |
| 2 | DL25018-2AWD-S | 2.50 | 7.50 | 10 | DL25018-10AWD-S | 22.50 | 27.50 |
| 3 | DL25018-3AWD-S | 5.00 | 10.00 | 11 | DL25018-11AWD-S | 25.00 | 30.00 |
| 4 | DL25018-4AWD-S | 7.50 | 12.50 | 12 | DL25018-12AWD-S | 27.50 | 32.50 |
| 5 | DL25018-5AWD-S | 10.00 | 15.00 | 13 | DL25018-13AWD-S | 30.00 | 35.00 |
| 6 | DL25018-6AWD-S | 12.50 | 17.50 | 14 | DL25018-14AWD-S | 32.50 | 37.50 |
| 7 | DL25018-7AWD-S | 15.00 | 20.00 | 15 | DL25018-15AWD-S | 35.00 | 40.00 |
| 8 | DL25018-8AWD-S | 17.50 | 22.50 | - | - | - | - |
| 9 | DL25018-9AWD-S | 20.00 | 25.00 | 20 | DL25018-20AWD-S | 47.50 | 52.50 |

| GENERAL TOLERANCES (UNLESS SPECIFIED) | | ZHE JIANG DELI CONNECTORS CO., LTD | |
|--|---------------|---|----------------|
| .X: ± 0.25 | X° : ± 3.0° | PRODUCT NAME: DL25018-AWD-S | |
| .XX: ± 0.15 | .X° : ± 2.0° | TITLE: 2.50 mm Pitch Wire To Board Wafer | |
| .XXX: ± 0.01 | .XX° : ± 1.0° | DR: Chen Quan Long | DATE: 20/08/01 |
| FINISH: | | CHKD: Wu Hui | DATE: 20/08/01 |
| DRAWING NO: | | APPD: Ren An De | DATE: 20/08/01 |
| | | PART NO: | |
| | | SCALE: N/A | PAGE: 1/1 |
| | | UNITS: mm | REV.: A |

| | | | |
|------|----------------------|------|------|
| REV. | REVISION DESCRIPTION | DATE | APPD |
| | | | |

NOTES

Available in 02 through 20 Circuits.

Match with DL25018 series housing

Material : Nylon UL94V-0(2).

Accepts DL25018-T Crimp Terminal.

CIRCUIT NO. 1

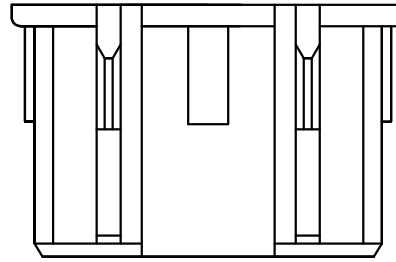
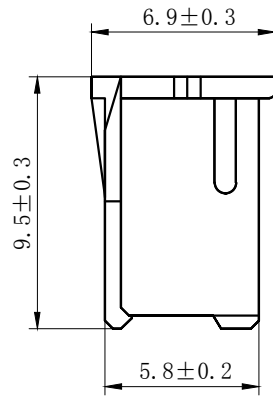
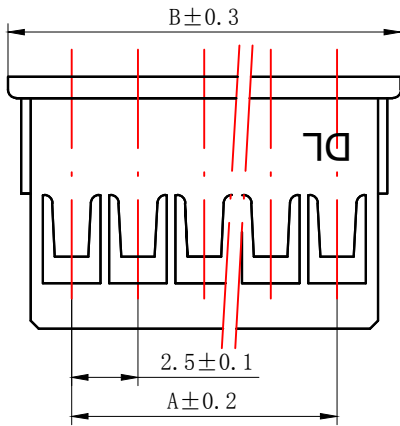
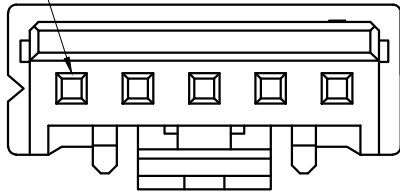

| Circuits | Product name | Dimension mm | | Circuits | Product name | Dimension mm | |
|----------|--------------|--------------|-------|----------|--------------|--------------|-------|
| | | A | B | | | A | B |
| 2 | DL25018-2Y | 2.50 | 7.30 | 12 | DL25018-12Y | 27.50 | 32.30 |
| 3 | DL25018-3Y | 5.00 | 9.80 | 13 | DL25018-13Y | 30.00 | 34.80 |
| 4 | DL25018-4Y | 7.50 | 12.30 | 14 | DL25018-14Y | 32.50 | 37.30 |
| 5 | DL25018-5Y | 10.00 | 14.80 | 15 | DL25018-15Y | 35.00 | 39.80 |
| 6 | DL25018-6Y | 12.50 | 17.30 | 16 | DL25018-16Y | 37.50 | 42.30 |
| 7 | DL25018-7Y | 15.00 | 19.80 | 17 | DL25018-17Y | 40.00 | 44.80 |
| 8 | DL25018-8Y | 17.50 | 22.30 | 18 | DL25018-18Y | 42.50 | 47.30 |
| 9 | DL25018-9Y | 20.00 | 24.80 | 19 | DL25018-19Y | 45.00 | 47.30 |
| 10 | DL25018-10Y | 22.50 | 27.30 | 20 | DL25018-20Y | 47.50 | 52.30 |
| 11 | DL25018-11Y | 25.00 | 29.80 | | | | |

| | | | |
|--|---------------|------------------------------------|---------------------------------|
| GENERAL TOLERANCES (UNLESS SPECIFIED) | | ZHE JIANG DELI CONNECTORS CO., LTD | |
| .X: ± 0.25 | X° : ± 3.0° | PRODUCT NAME: DL25018-Y | TITLE: 2.50 mm Pitch Housing |
| .XX: ± 0.15 | .X° : ± 2.0° | DR: Chen Quan Long | DATE: 20/08/01 |
| .XXX: ± 0.01 | .XX° : ± 1.0° | DATE: 20/08/01 | PART NO: |
| FINISH: | | CHKD: Wu Hui | DATE: 20/08/01 |
| DRAWING NO: | | APPD: Ren An De | DATE: 20/08/01 |
| | | SCALE: N/A | PAGE: 1/1 |
| | | UNITS: mm | REV.: A |

| | | | |
|------|----------------------|------|------|
| REV. | REVISION DESCRIPTION | DATE | APPD |
| | | | |

NORES:

1. Rated voltage: 250V AC/DC
2. Rated current: 3A AC DC
3. Contact resistance: $\leq 20 \text{ m}\Omega$
4. Insulation resistance: $\geq 500 \text{ m}\Omega$
5. Withstand voltage: 1500V AC/minute
6. Ambient temperature: $-25^{\circ}\text{C} \sim 85^{\circ}\text{C}$
7. Materials: Nylon UL94V-0 (2)
8. Matched RoHS criteria



安装尺寸图

| Circuits | Product name | Dimension mm | | | | | Circuits | Product name | Dimension mm | | | | |
|----------|--------------|--------------|-------|-------|-------|-------|----------|--------------|--------------|-------|-------|-------|-------|
| | | A | B | C | D | E | | | A | B | C | D | E |
| 2 | DL25018-2R | 2.50 | 7.50 | 5.90 | 7.90 | 11.20 | 10 | DL25018-10R | 22.50 | 27.50 | 25.90 | 27.90 | 31.20 |
| 3 | DL25018-3R | 5.00 | 10.00 | 8.40 | 10.40 | 13.70 | 11 | DL25018-11R | 25.00 | 30.00 | 28.40 | 30.40 | 33.70 |
| 4 | DL25018-4R | 7.50 | 12.50 | 10.90 | 12.90 | 16.20 | 12 | DL25018-12R | 27.50 | 32.50 | 30.90 | 32.90 | 36.20 |
| 5 | DL25018-5R | 10.00 | 15.00 | 13.40 | 15.40 | 18.70 | 13 | DL25018-13R | 30.00 | 35.00 | 33.40 | 35.40 | 38.70 |
| 6 | DL25018-6R | 12.50 | 17.50 | 15.90 | 17.90 | 21.20 | 14 | DL25018-14R | 32.50 | 37.50 | 35.90 | 37.90 | 41.20 |
| 7 | DL25018-7R | 15.00 | 20.00 | 18.40 | 20.40 | 23.70 | 15 | DL25018-15R | 35.00 | 40.00 | 38.40 | 40.40 | 43.70 |
| 8 | DL25018-8R | 17.50 | 22.50 | 20.90 | 22.90 | 26.20 | - | - | - | - | - | - | - |
| 9 | DL25018-9R | 20.00 | 25.00 | 23.40 | 25.40 | 28.70 | 20 | DL25018-20R | 47.50 | 52.50 | 50.90 | 52.90 | 56.20 |

| | | | |
|---------------------------------------|--------------|------------------------------------|--|
| GENERAL TOLERANCES (UNLESS SPECIFIED) | | ZHE JIANG DELI CONNECTORS CO., LTD | |
| .X: ± 0.25 | X°: ± 3.0° | PRODUCT NAME: DL25018-R | TITLE: 2.50 mm Pitch Wire To Wire Housing |
| .XX: ± 0.15 | .X°: ± 2.0° | DR: Yuan Jun Rong | DATE: 21/12/30 |
| .XXX: ± 0.01 | .XX°: ± 1.0° | DATE: 21/12/30 | PART NO: |
| FINISH: | | CHKD: Wu Hui | DATE: 21/12/30 |
| DRAWING NO: | | APPD: Ren An De | DATE: 21/12/30 |
| | | SCALE: N/A | PAGE: 1/1 |
| | | UNITS: mm | REV.: A |

| | | | |
|------|----------------------|------|------|
| REV. | REVISION DESCRIPTION | DATE | APPD |
| | | | |

NORES:

1. Rated voltage: 250V AC/DC
2. Rated current: 3A AC/DC
3. Contact resistance: $\leq 20 \text{ m}\Omega$
4. Insulation resistance: $\geq 500 \text{ m}\Omega$
5. Withstand voltage: 1500V AC/minute
6. Ambient temperature: $-25^{\circ}\text{C} \sim 85^{\circ}\text{C}$
7. Materials: Nylon UL94V-0(2)
8. Matched RoHS criteria

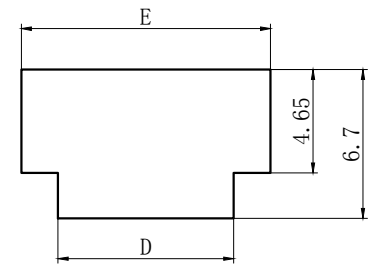
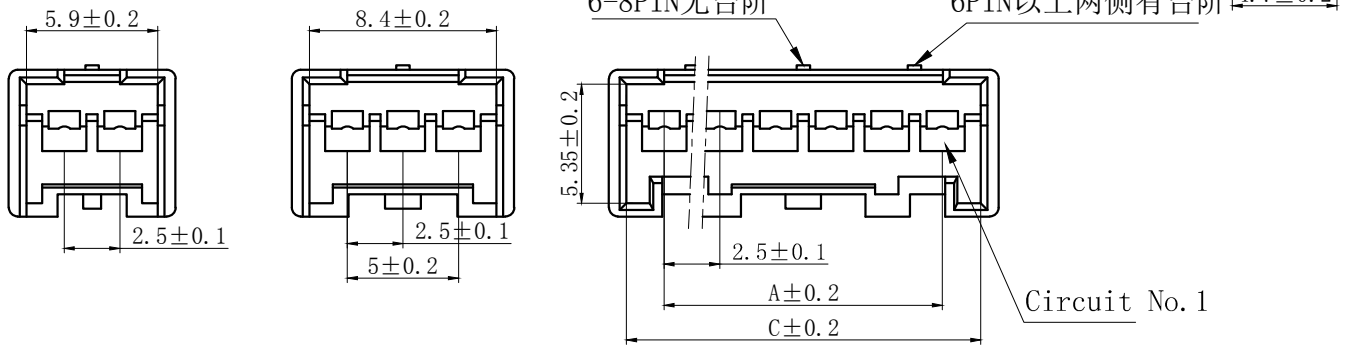
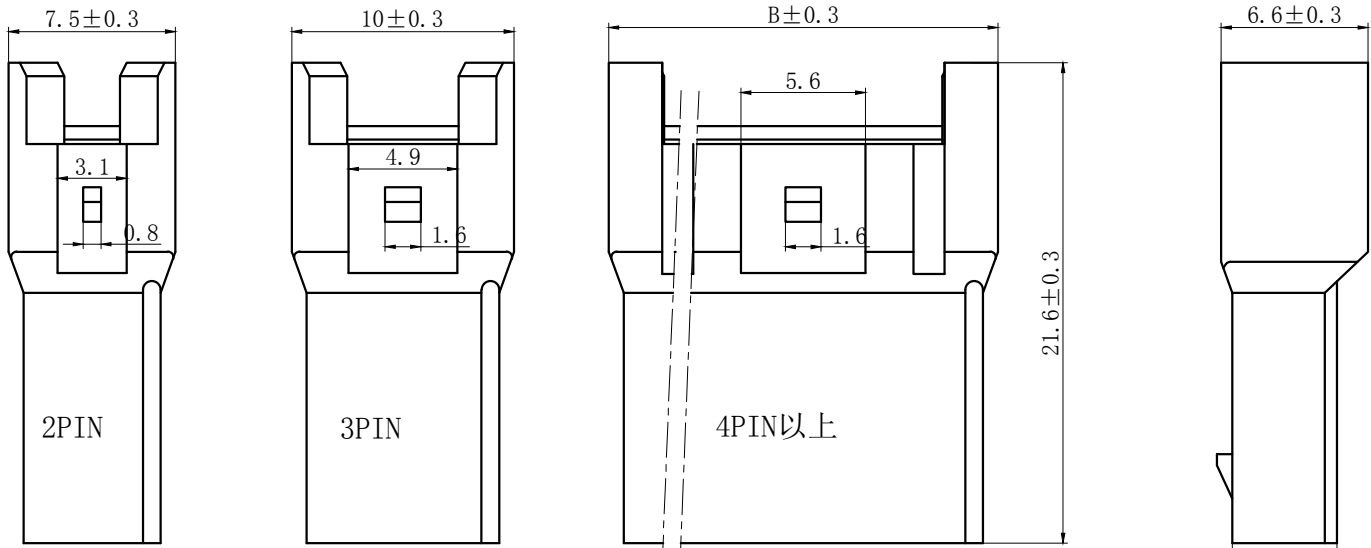

安装尺寸图

| Circuits | Product name | Dimension mm | | | | | Circuits | Product name | Dimension mm | | | | |
|----------|--------------|--------------|-------|-------|-------|-------|----------|--------------|--------------|-------|-------|-------|-------|
| | | A | B | C | D | E | | | A | B | C | D | E |
| 2 | DL25018-2RF | 2.50 | 7.50 | 5.90 | 7.90 | 11.20 | 10 | DL25018-10RF | 22.50 | 27.50 | 25.90 | 27.90 | 31.20 |
| 3 | DL25018-3RF | 5.00 | 10.00 | 8.40 | 10.40 | 13.70 | 11 | DL25018-11RF | 25.00 | 30.00 | 28.40 | 30.40 | 33.70 |
| 4 | DL25018-4RF | 7.50 | 12.50 | 10.90 | 12.90 | 16.20 | 12 | DL25018-12RF | 27.50 | 32.50 | 30.90 | 32.90 | 36.20 |
| 5 | DL25018-5RF | 10.00 | 15.00 | 13.40 | 15.40 | 18.70 | 13 | DL25018-13RF | 30.00 | 35.00 | 33.40 | 35.40 | 38.70 |
| 6 | DL25018-6RF | 12.50 | 17.50 | 15.90 | 17.90 | 21.20 | 14 | DL25018-14RF | 32.50 | 37.50 | 35.90 | 37.90 | 41.20 |
| 7 | DL25018-7RF | 15.00 | 20.00 | 18.40 | 20.40 | 23.70 | 15 | DL25018-15RF | 35.00 | 40.00 | 38.40 | 40.40 | 43.70 |
| 8 | DL25018-8RF | 17.50 | 22.50 | 20.90 | 22.90 | 26.20 | - | - | - | - | - | - | - |
| 9 | DL25018-9RF | 20.00 | 25.00 | 23.40 | 25.40 | 28.70 | 20 | DL25018-20RF | 47.50 | 52.50 | 50.90 | 52.90 | 56.20 |

| | | | |
|---------------------------------------|-------------------------|------------------------------------|--|
| GENERAL TOLERANCES (UNLESS SPECIFIED) | | ZHE JIANG DELI CONNECTORS CO., LTD | |
| .X: ± 0.25 | X°: $\pm 3.0^{\circ}$ | PRODUCT NAME: DL25018-RF | TITLE: 2.50 mm Pitch Wire To Wire Housing |
| .XX: ± 0.15 | .X°: $\pm 2.0^{\circ}$ | DR: Yuan Jun Rong | DATE: 21/12/30 |
| .XXX: ± 0.01 | .XX°: $\pm 1.0^{\circ}$ | DATE: 21/12/30 | PART NO: |
| FINISH: | | CHKD: Wu Hui | DATE: 21/12/30 |
| DRAWING NO: | | APPD: Ren An De | DATE: 21/12/30 |
| | | SCALE: N/A | PAGE: 1/1 |
| | | UNITS: mm | REV.: A |

| | | | |
|------|----------------------|------|------|
| REV. | REVISION DESCRIPTION | DATE | APPD |
| | | | |



NOTES
 Available in 02 through 20 Circuits.
 Match with DL25018-Y series housing
 Material : Nylon UL94V-0(2).

| Circuits | Product name | Dimension mm | | Circuits | Product name | Dimension mm | |
|----------|--------------|--------------|------|----------|--------------|--------------|------|
| | | A | B | | | A | B |
| 2 | DL25018-2S | 2.50 | 8.9 | 10 | DL25018-10S | 22.50 | 28.9 |
| 3 | DL25018-3S | 5.00 | 11.4 | 11 | DL25018-11S | 25.00 | 31.4 |
| 4 | DL25018-4S | 7.50 | 13.9 | 12 | DL25018-12S | 27.50 | 33.9 |
| 5 | DL25018-5S | 10.00 | 16.4 | 13 | DL25018-13S | 30.00 | 36.4 |
| 6 | DL25018-6S | 12.50 | 18.9 | 14 | DL25018-14S | 32.50 | 38.9 |
| 7 | DL25018-7S | 15.00 | 21.4 | 15 | DL25018-15S | 35.00 | 41.4 |
| 8 | DL25018-8S | 17.50 | 23.9 | - | - | - | - |
| 9 | DL25018-9S | 20.00 | 26.4 | 20 | DL25018-20S | 47.50 | 43.9 |

| | | | |
|--|--------------|------------------------------------|---------------------------------|
| GENERAL TOLERANCES (UNLESS SPECIFIED) | | ZHE JIANG DELI CONNECTORS CO., LTD | |
| .X: ± 0.25 | X°: ± 3.0° | PRODUCT NAME: DL25018-S | TITLE: 2.50 mm Pitch Housing |
| .XX: ± 0.15 | .X°: ± 2.0° | DR: Yuan Jun Rong | DATE: 20/08/01 |
| .XXX: ± 0.01 | .XX°: ± 1.0° | DATE: 20/08/01 | PART NO: |
| FINISH: | | CHKD: Wu Hui | SCALE: N/A |
| DRAWING NO: | | APPD: Ren An De | DATE: 20/08/01 |
| | | | PAGE: 1/1 |
| | | | UNITS: mm |
| | | | REV.: A |

| | | | |
|------|----------------------|------|------|
| REV. | REVISION DESCRIPTION | DATE | APPD |
| | | | |

6-8Pin

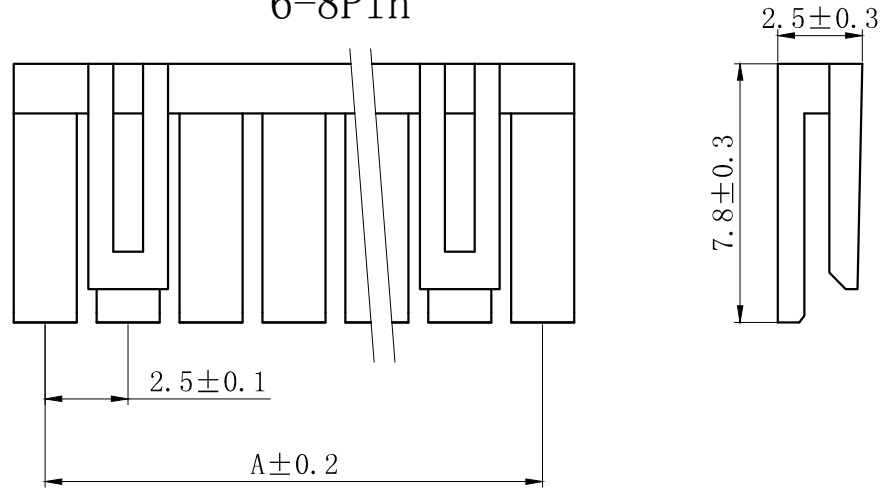

NOTES

Available in 02 through 20 Circuits.
 Mates with DL25018-R/DL25034-RK/
 DL25035/DL25045 Series Housing.
 Material : Nylon UL94-V0(2).
 Green Material RoHS Compliant.

1-5Pin

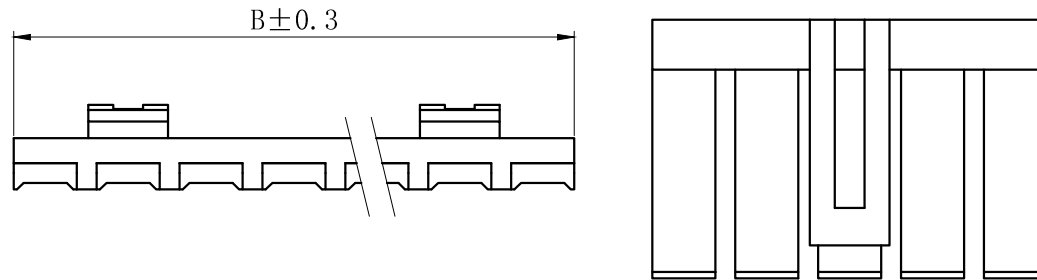

9-20Pin

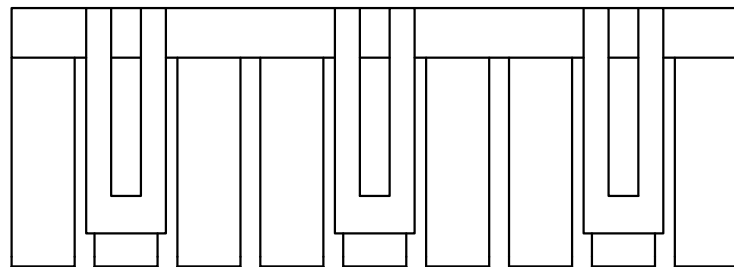

| Circuits | Product name | Dimension mm | | Circuits | Product name | Dimension mm | |
|----------|--------------|--------------|------|----------|--------------|--------------|------|
| | | A | B | | | A | B |
| 2 | DL25018-2RS | 2.50 | 4.4 | 10 | DL25018-10RS | 22.50 | 24.4 |
| 3 | DL25018-3RS | 5.00 | 6.9 | 11 | DL25018-11RS | 25.00 | 26.9 |
| 4 | DL25018-4RS | 7.50 | 9.4 | 12 | DL25018-12RS | 27.50 | 29.4 |
| 5 | DL25018-5RS | 10.00 | 11.9 | 13 | DL25018-13RS | 30.00 | 31.9 |
| 6 | DL25018-6RS | 12.50 | 14.4 | 14 | DL25018-14RS | 32.50 | 34.4 |
| 7 | DL25018-7RS | 15.00 | 16.9 | 15 | DL25018-15RS | 35.00 | 36.9 |
| 8 | DL25018-8RS | 17.50 | 19.4 | - | - | - | - |
| 9 | DL25018-9RS | 20.00 | 21.9 | 20 | DL25018-RS | 47.50 | 49.4 |

| | | | | | |
|--|--------------|------------------------------------|----------------|-------------------------------------|-----------|
| GENERAL TOLERANCES (UNLESS SPECIFIED) | | ZHE JIANG DELI CONNECTORS CO., LTD | | | |
| .X: ± 0.25 | X°: ± 3.0° | PRODUCT NAME: DL25018-RS | | TITLE: 2.5 mm Pitch Wire To Wire | |
| .XX: ± 0.15 | .X°: ± 2.0° | DR: Chen Quan Long | DATE: 21/05/01 | PART NO: | |
| .XXX: ± 0.01 | .XX°: ± 1.0° | CHKD: Wu Hui | DATE: 21/05/01 | SCALE: N/A | PAGE: 1/1 |
| DRAWING NO: | | APPD: Ren An De | DATE: 21/05/01 | UNITS: mm | REV.: A |

| REV. | REVISION DESCRIPTION | DATE | APPD |
|------|----------------------|------|------|
| | | | |

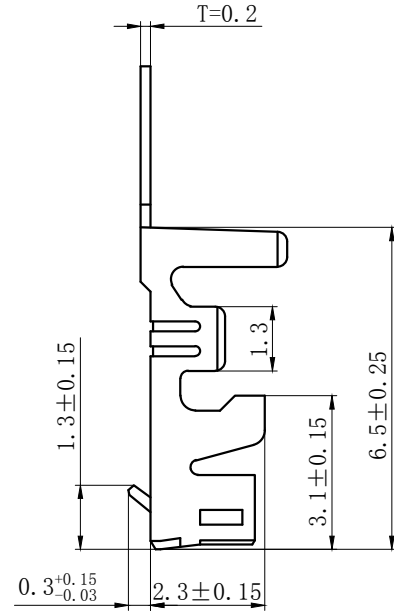

技术特性/Specifications:

额定电压Rated voltage :250V AC.DC.
 额定电流Rated current :3A AC.DC.
 接触电阻Contact resistance:20MΩ MAX
 绝缘电阻Insulation resistance: 1000 MΩ MIN
 耐压Withstand voltage:1000V AC/minute
 环境温度Ambient temperature: -40℃~+105℃
 适用线规 Wire range: AWG#28~#20

材料/Materials:

端子Terminal: 磷青铜Phosphor bronze ,
 镀锡Tin plated



SECTION A-A



SECTION B-B



SECTION C-C

| Product name | Dimension (mm) | | | | Applicable wire | Insulation O.D. (mm) |
|--------------|----------------|-----|-----|-----|-----------------|----------------------|
| | A1 | B1 | A2 | B2 | | |
| DL25018-T | 2.9 | 3.0 | 1.9 | 1.6 | AWG#28-22 | 1.9mm Max |
| DL25018-T-G | 2.9 | 3.0 | 2.3 | 2.1 | AWG#24-20 | 1.9mm Max |

| GENERAL TOLERANCES (UNLESS SPECIFIED) | | | | ZHE JIANG DELI CONNECTORS CO., LTD | | | |
|---------------------------------------|--------------|----------------------------|--|---|---------|---------------|-----------|
| .X: ± 0.25 | X°: ± 3.0° | PRODUCT NAME: DL25018-T | | TITLE: 2.50 mm Pitch Crimp Terminal | | | |
| .XX: ± 0.15 | .X°: ± 2.0° | DR: Yuan Jun Rong | | DATE:21/12/30 | | PART NO: | |
| .XXX: ± 0.01 | .XX°: ± 1.0° | FINISH: | | CHKD: Wu Hui | | DATE:21/12/30 | |
| DRAWING NO: | | APPD:Ren An De | | DATE:21/12/30 | | SCALE: N/A | PAGE: 1/1 |
| | | | | UNITS: mm | REV.: A | | |

| REV. | REVISION DESCRIPTION | DATE | APPD |
|------|----------------------|------|------|
| | | | |



SECTION A-A



SECTION B-B

技术特性/Specifications:

额定电压Rated voltage :250V AC.DC.
 额定电流Rated current :3A AC.DC.
 接触电阻Contact resistance:20MΩ MAX
 绝缘电阻Insulation resistance: 500 MΩ MIN
 耐压Withstand voltage:1500V AC/minute
 环境温度Ambient temperature: -40℃~+105℃
 适用线规 Wire range: AWG#28~#20

材料/Materials:

端子Terminal: 磷青铜Phosphor bronze ,
 镀锡Tin plated

| Product name | Dimension (mm) | | | | Applicable wire | Insulation O.D. (mm) |
|--------------|----------------|-----|-----|-----|-----------------|----------------------|
| | A1 | B1 | A2 | B2 | | |
| DL25018-RT | 2.9 | 2.9 | 1.9 | 1.5 | AWG#28-22 | 1.9mm Max |
| DL25018-RT-G | 2.9 | 2.9 | 2.2 | 2.1 | AWG#24-20 | 1.9mm Max |

| GENERAL TOLERANCES (UNLESS SPECIFIED) | | ZHE JIANG DELI CONNECTORS CO., LTD | |
|---------------------------------------|--------------|------------------------------------|--|
| .X: ± 0.25 | X°: ± 3.0° | PRODUCT NAME: | TITLE: |
| .XX: ± 0.15 | .X°: ± 2.0° | DL25018-RT | 2.50 mm Pitch Wire To Wire Terminal |
| .XXX: ± 0.01 | .XX°: ± 1.0° | DR:Yuan Jun Rong | DATE:21/12/30 |
| FINISH: | | CHKD:Wu Hui | DATE:21/12/30 |
| DRAWING NO: | | APPD:Ren An De | DATE:21/12/30 |
| | | | PART NO: |
| | | | SCALE: N/A |
| | | | PAGE: 1/1 |
| | | | UNITS: mm |
| | | | REV.: A |

| REV. | REVISION DESCRIPTION | DATE | APPD |
|------|----------------------|------|------|
| | | | |

NOTES

Available in 02 through 20 Circuits.
 Mates with DL25018-Y Series Housing.
 Material : Nylon UL94V-0.
 0.60mm Square Pin.
 Pin Material : Brass / Tin-Plated.

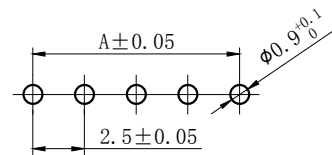
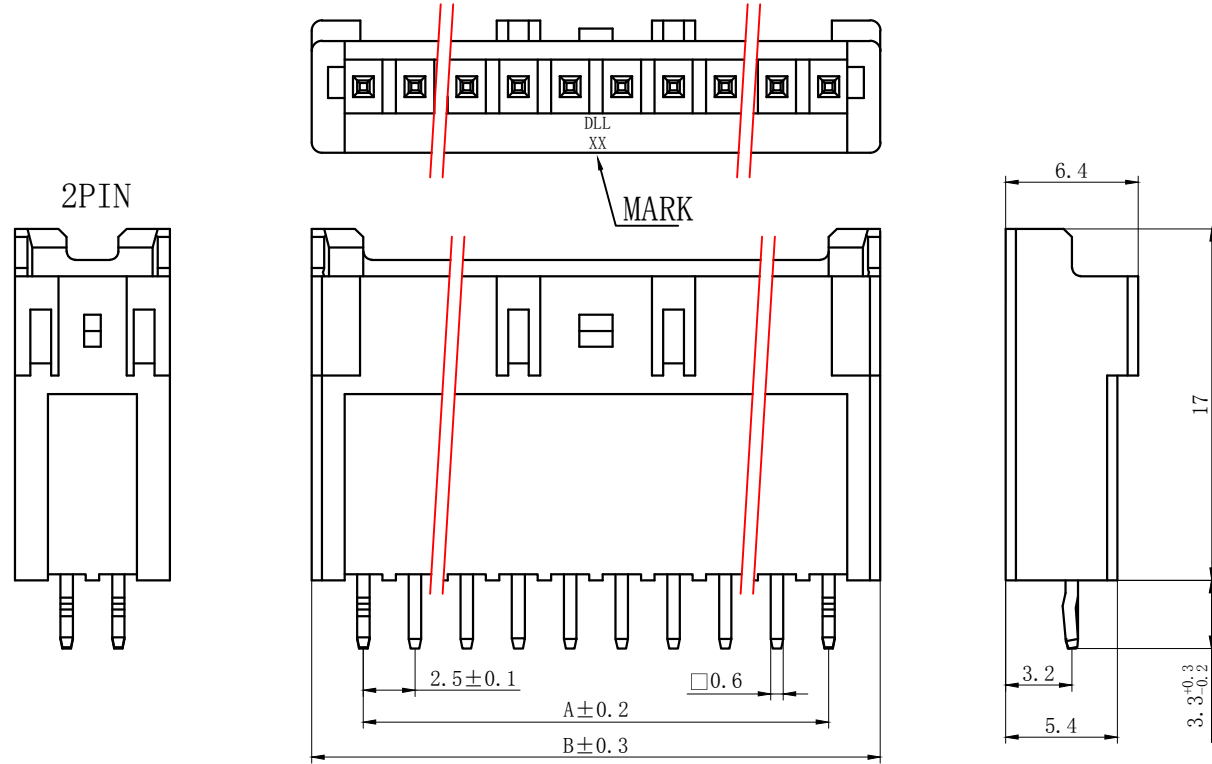

P. C. B LATOUT

| Circuits | Product name | Dimension mm | | | Circuits | Product name | Dimension mm | | |
|----------|--------------|--------------|-------|-------|----------|--------------|--------------|-------|-------|
| | | A | B | C | | | A | B | C |
| 2 | XAH-2A | 2.50 | 7.50 | 5.90 | 10 | XAH-10A | 22.50 | 27.50 | 25.90 |
| 3 | XAH-3A | 5.00 | 10.00 | 8.40 | 11 | XAH-11A | 25.00 | 30.00 | 28.40 |
| 4 | XAH-4A | 7.50 | 12.50 | 10.90 | 12 | XAH-12A | 27.50 | 32.50 | 30.90 |
| 5 | XAH-5A | 10.00 | 15.00 | 13.40 | 13 | XAH-13A | 30.00 | 35.00 | 33.40 |
| 6 | XAH-6A | 12.50 | 17.50 | 15.90 | 14 | XAH-14A | 32.50 | 37.50 | 35.90 |
| 7 | XAH-7A | 15.00 | 20.00 | 18.40 | 15 | XAH-15A | 35.00 | 40.00 | 38.40 |
| 8 | XAH-8A | 17.50 | 22.50 | 20.90 | - | - | - | - | - |
| 9 | XAH-9A | 20.00 | 25.00 | 23.40 | 20 | XAH-20A | 47.50 | 52.50 | 50.90 |

GENERAL TOLERANCES (UNLESS SPECIFIED)

| | |
|--------------|---------------|
| .X: ± 0.25 | X° : ± 3.0° |
| .XX: ± 0.15 | .X° : ± 2.0° |
| .XXX: ± 0.01 | .XX° : ± 1.0° |
| FINISH: | |
| DRAWING NO: | |

ZHE JIANG DELI CONNECTORS CO., LTD

| | | | |
|--|----------------|--|-----------|
| PRODUCT NAME: DL25035 (XAH) -A | | TITLE: 2.50 mm Pitch Wire To Board Wafer | |
| DR: Yuan Jun Rong | DATE: 19/07/20 | PART NO: | |
| CHKD: Wu Hui | DATE: 19/07/20 | SCALE: N/A | PAGE: 1/1 |
| APPD: Ren An De | DATE: 19/07/20 | UNITS: mm | REV.: A |

| | | | |
|------|----------------------|------|------|
| REV. | REVISION DESCRIPTION | DATE | APPD |
| | | | |

NOTES

Available in 02 through 20 Circuits.
Mates with DL25018-Y Series Housing.
Material : Nylon UL94V-0.
0.60mm Square Pin.
Pin Material : Brass / Tin-Plated.

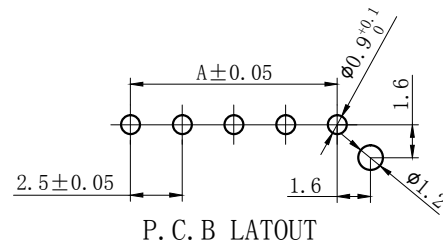
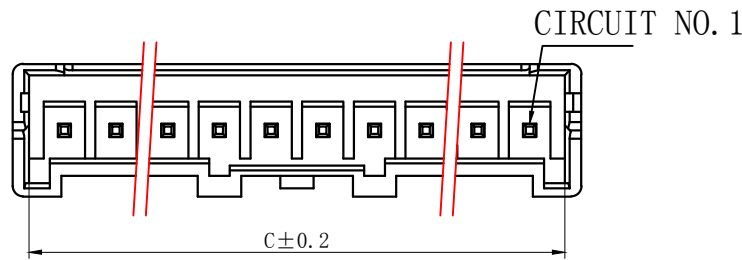
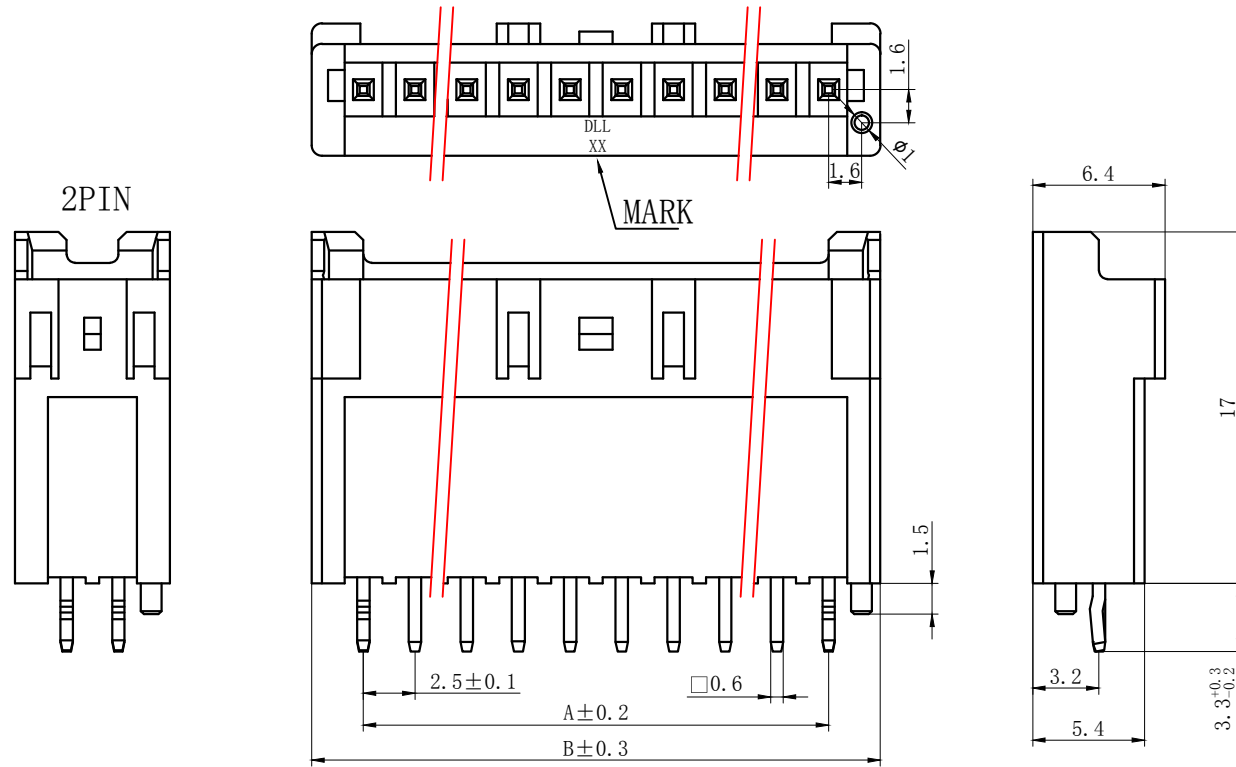

| Circuits | Product name | Dimension mm | | | Circuits | Product name | Dimension mm | | |
|----------|--------------|--------------|-------|-------|----------|--------------|--------------|-------|-------|
| | | A | B | C | | | A | B | C |
| 2 | XAH-2AS | 2.50 | 7.50 | 5.90 | 10 | XAH-10AS | 22.50 | 27.50 | 25.90 |
| 3 | XAH-3AS | 5.00 | 10.00 | 8.40 | 11 | XAH-11AS | 25.00 | 30.00 | 28.40 |
| 4 | XAH-4AS | 7.50 | 12.50 | 10.90 | 12 | XAH-12AS | 27.50 | 32.50 | 30.90 |
| 5 | XAH-5AS | 10.00 | 15.00 | 13.40 | 13 | XAH-13AS | 30.00 | 35.00 | 33.40 |
| 6 | XAH-6AS | 12.50 | 17.50 | 15.90 | 14 | XAH-14AS | 32.50 | 37.50 | 35.90 |
| 7 | XAH-7AS | 15.00 | 20.00 | 18.40 | 15 | XAH-15AS | 35.00 | 40.00 | 38.40 |
| 8 | XAH-8AS | 17.50 | 22.50 | 20.90 | - | - | - | - | - |
| 9 | XAH-9AS | 20.00 | 25.00 | 23.40 | 20 | XAH-20AS | 47.50 | 52.50 | 50.90 |

| | | | |
|---------------------------------------|--------------|------------------------------------|--|
| GENERAL TOLERANCES (UNLESS SPECIFIED) | | ZHE JIANG DELI CONNECTORS CO., LTD | |
| .X: ± 0.25 | X°: ± 3.0° | PRODUCT NAME: DL25035 (XAH)-AS | TITLE: 2.50 mm Pitch Wire To Board Wafer |
| .XX: ± 0.15 | .X°: ± 2.0° | DR: Yuan Jun Rong | DATE: 19/07/20 |
| .XXX: ± 0.01 | .XX°: ± 1.0° | CHKD: Wu Hui | DATE: 19/07/20 |
| FINISH: | | APPD: Ren An De | DATE: 19/07/20 |
| DRAWING NO: | | | PART NO: |
| | | | SCALE: N/A |
| | | | PAGE: 1/1 |
| | | | UNITS: mm |
| | | | REV.: A |

| REV. | REVISION DESCRIPTION | DATE | APPD |
|------|----------------------|------|------|
| | | | |

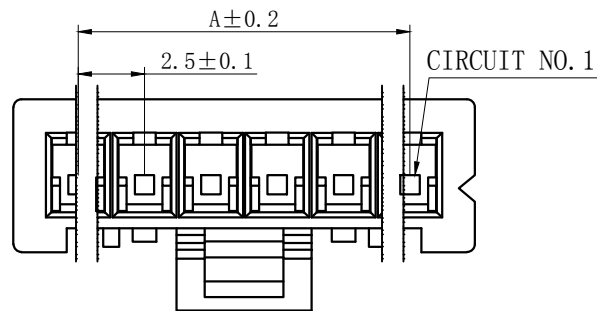
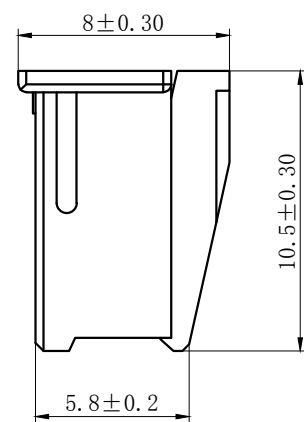
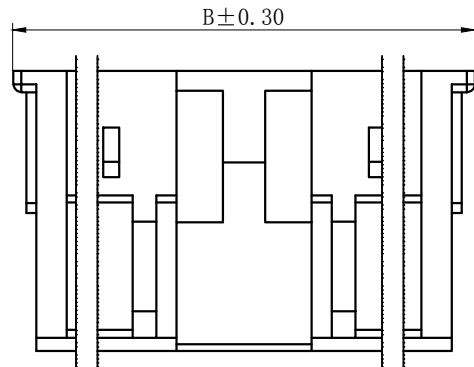
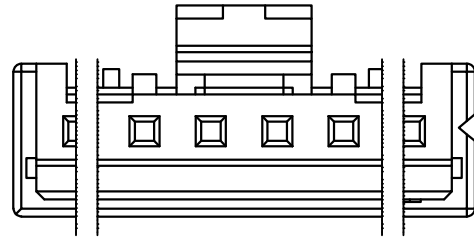

NOTES

Available in 02 through 20 Circuits.
 Match with DL25018 or DL25035 series housing
 Material : Nylon UL94V-0(2).
 Accepts DL25035-T Crimp Terminal.

| Circuits | Product name | Dimension mm | | Circuits | Product name | Dimension mm | |
|----------|--------------|--------------|-------|----------|--------------|--------------|-------|
| | | A | B | | | A | B |
| 2 | XAH-2Y | 2.50 | 7.30 | 12 | XAH-12Y | 27.50 | 32.30 |
| 3 | XAH-3Y | 5.00 | 9.80 | 13 | XAH-13Y | 30.00 | 34.80 |
| 4 | XAH-4Y | 7.50 | 12.30 | 14 | XAH-14Y | 32.50 | 37.30 |
| 5 | XAH-5Y | 10.00 | 14.80 | 15 | XAH-15Y | 35.00 | 39.80 |
| 6 | XAH-6Y | 12.50 | 17.30 | 16 | XAH-16Y | 37.50 | 42.30 |
| 7 | XAH-7Y | 15.00 | 19.80 | 17 | XAH-17Y | 40.00 | 44.80 |
| 8 | XAH-8Y | 17.50 | 22.30 | 18 | XAH-18Y | 42.50 | 47.30 |
| 9 | XAH-9Y | 20.00 | 24.80 | 19 | XAH-19Y | 45.00 | 47.30 |
| 10 | XAH-10Y | 22.50 | 27.30 | 20 | XAH-20Y | 47.50 | 52.30 |
| 11 | XAH-11Y | 25.00 | 29.80 | | | | |

| GENERAL TOLERANCES (UNLESS SPECIFIED) | | ZHE JIANG DELI CONNECTORS CO ., LTD | |
|--|---------------|--|---------------------------------|
| .X: ± 0.25 | X° : ± 3.0° | PRODUCT NAME: DL25035 (XAH) -Y | TITLE: 2.50 mm Pitch Housing |
| .XX: ± 0.15 | .X° : ± 2.0° | DR:Chen Quan Long | DATE:20/08/01 |
| .XXX: ± 0.01 | .XX° : ± 1.0° | CHKD: Wu Hui | DATE:20/08/01 |
| FINISH: _____ | | APPD:Ren An De | DATE:20/08/01 |
| DRAWING NO: | | | |
| | | | |

X-ON Electronics

Largest Supplier of Electrical and Electronic Components

Click to view similar products for [Headers & Wire Housings](#) category:

Click to view products by [DLL](#) manufacturer:

Other Similar products are found below :

[0015917161](#) [0022155065](#) [57102-F02-18ULF](#) [58102-G61-06LF](#) [582553-1](#) [01.001.5753.1](#) [0050291907](#) [02.125.8002.8](#) [609-3404](#) [61062-3](#)
[CSU011177004](#) [622-0430](#) [622-3653LF](#) [63453-116](#) [636-1030](#) [636-1427](#) [636-3427](#) [636-4007](#) [641938-9](#) [65495-038](#) [65692-001LF](#) [65781-018](#)
[65781-047](#) [65817-010LF](#) [65817-015LF](#) [67095-007LF](#) [67601157](#) [68631-112](#) [68645-018](#) [699319-000](#) [70.362.1628.0](#) [70-4210](#) [70-4226B](#) [70-](#)
[4853B](#) [71.350.2428.0](#) [733-134](#) [733-162](#) [760-3052](#) [MHR-64-VUAL](#) [80.063.4001.1](#) [800-90-001-10-001000](#) [801-43-002-10-013000](#)
[801-43-006-10-002000](#) [803-43-024-10-001000](#) [803-93-012-10-001000](#) [8-1437020-4](#) [819-22-004-30-001101](#) [820-22-006-30-001101](#)
[820-22-008-30-001101](#) [821-22-002-10-001101](#)