

**技术特性/Specifications:**

额定电压 Rated voltage: 250V AC, DC  
额定电流 Rated current: 3A AC, DC  
接触电阻 Contact resistance: 20m $\Omega$  max  
绝缘电阻 Insulation resistance: 1000M $\Omega$  min  
耐压 Withstand voltage: 1000V AC/minute  
环境温度 Ambient temperature: -40 $^{\circ}$ C~+105 $^{\circ}$ C  
适用线规 Wire range: AWG#28~#20

REV.	REVISION DESCRIPTION	DATE	APPD

### NOTES

Available in 02 Circuits.  
 Mates with DL25026-Y Series Housing.  
 Material : Nylon UL94V-0(2).  
 0.64mm Square Pin.  
 Pin Material : Brass / Tin-Plated.

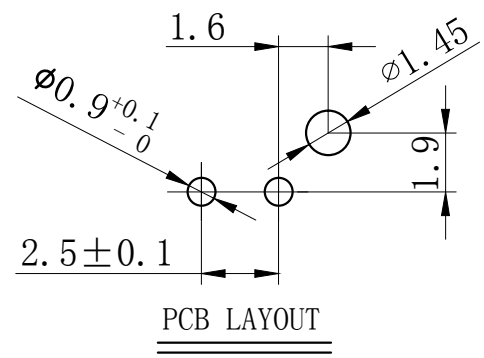
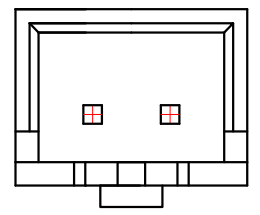
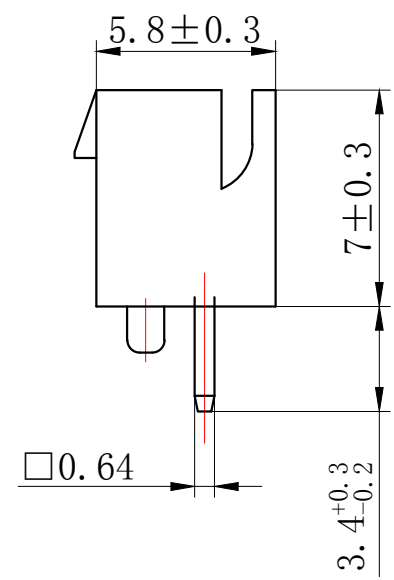
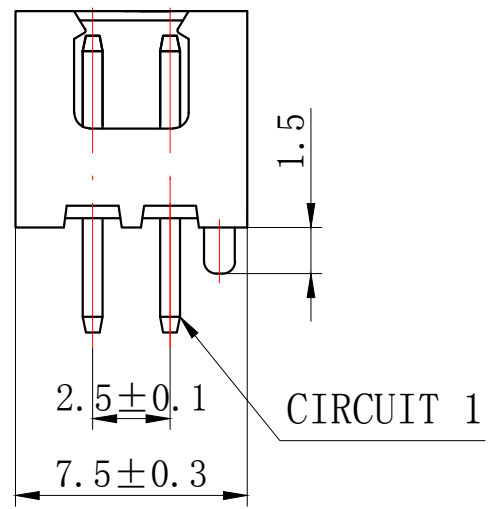
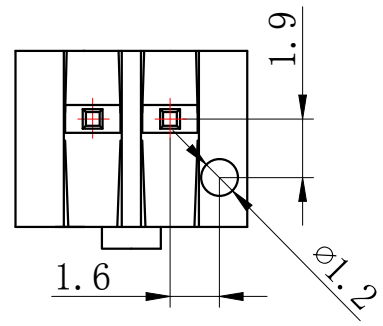

GENERAL TOLERANCES (UNLESS SPECIFIED)		ZHE JIANG DELI CONNECTORS CO., LTD	
.X: ±0.25	X°: ±3.0°	PRODUCT NAME:	TITLE: 2.50 mm Pitch Wire To Board Wafer
.XX: ±0.15	.X°: ±2.0°	DL25026 (XHDH)-2AS	
.XXX: ±0.01	.XX°: ±1.0°	DR: Chen Quan Long	DATE:19/08/01
FINISH:		CHKD: Wu Hui	DATE:19/08/01
DRAWING NO:		APPD: Ren An De	DATE:19/08/01
		SCALE: N/A	PAGE: 1/1
		UNITS: mm	REV.: A

REV.	REVISION DESCRIPTION	DATE	APPD

### NOTES

Available in 03 through 20 Circuits.  
 Mates with DL25026-Y Series Housing.  
 Material : Nylon UL94V-0(2).  
 0.64mm Square Pin.  
 Pin Material : Brass / Tin-Plated.

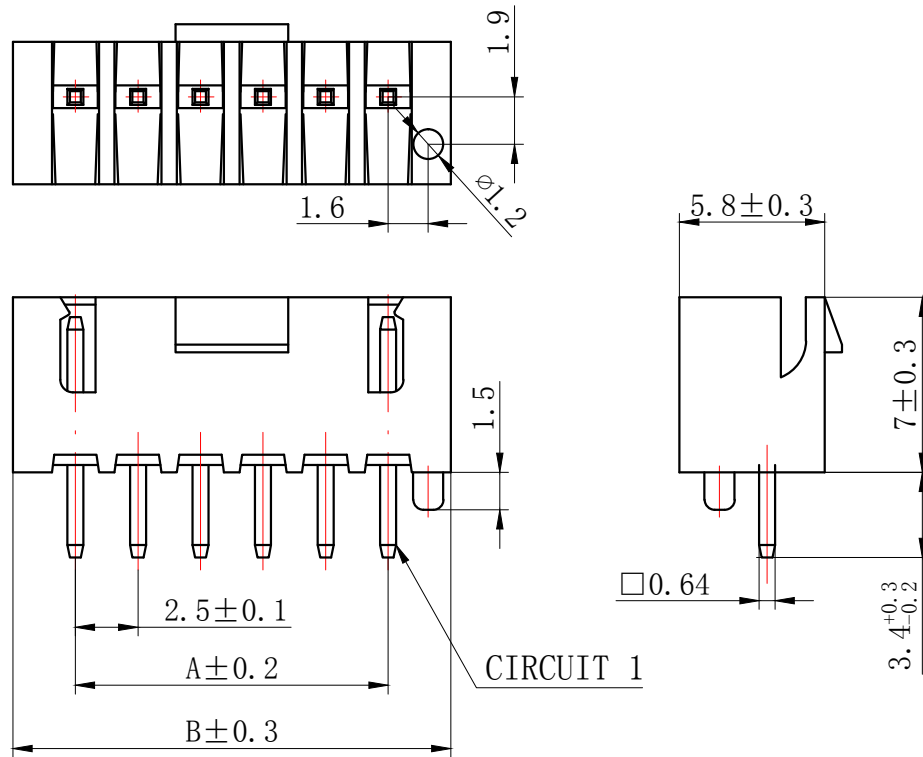
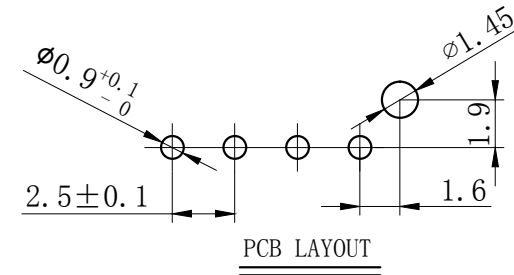

Circuits	Product name	Dimension mm		Circuits	Product name	Dimension mm	
		A	B			A	B
3	XHDH-3AS	5.00	10.00	10	XHDH-10AS	22.50	27.50
4	XHDH-4AS	7.50	12.50	11	XHDH-11AS	25.00	30.00
5	XHDH-5AS	10.00	15.00	12	XHDH-12AS	27.50	32.50
6	XHDH-6AS	12.50	17.50	13	XHDH-13AS	30.00	35.00
7	XHDH-7AS	15.00	20.00	14	XHDH-14AS	32.50	37.50
8	XHDH-8AS	17.50	22.50	-	-	-	-
9	XHDH-9AS	20.00	25.00	20	XHDH-20AS	47.5	52.5

GENERAL TOLERANCES (UNLESS SPECIFIED)		ZHE JIANG DELI CONNECTORS CO., LTD	
.X: ±0.25	X°: ±3.0°	PRODUCT NAME: DL25026 (XHDH)-AS	TITLE: 2.50 mm Pitch Wire To Board Wafer
.XX: ±0.15	.X°: ±2.0°	DR: Chen Quan Long	DATE: 19/08/01
.XXX: ±0.01	.XX°: ±1.0°	CHKD: Wu Hui	DATE: 19/08/01
FINISH:		APPD: Ren An De	DATE: 19/08/01
DRAWING NO:			
		PART NO:	SCALE: N/A
		UNITS: mm	PAGE: 1/1
		REV.: A	

REV.	REVISION DESCRIPTION	DATE	APPD

### NOTES

Available in 03 through 20 Circuits.  
 Mates with DL25026-Y Series Housing.  
 Material : Nylon UL94V-0(2).  
 0.64mm Square Pin.  
 Pin Material : Brass / Tin-Plated.

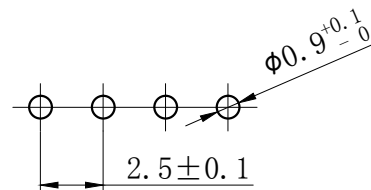
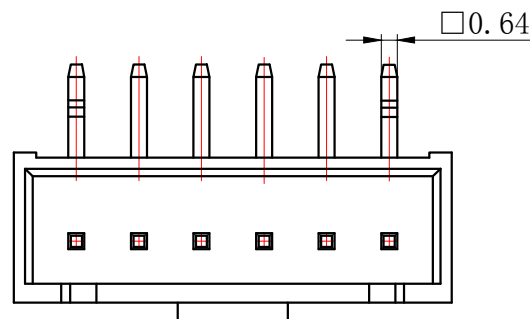
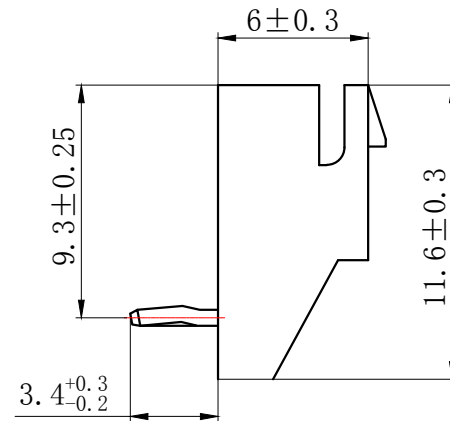
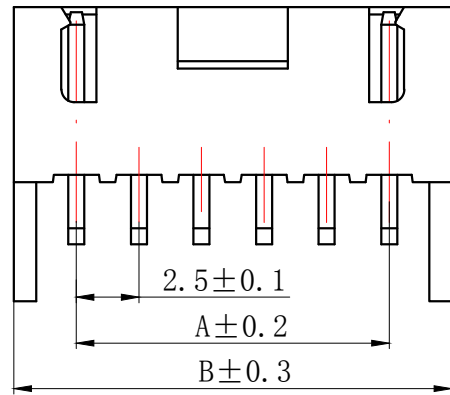
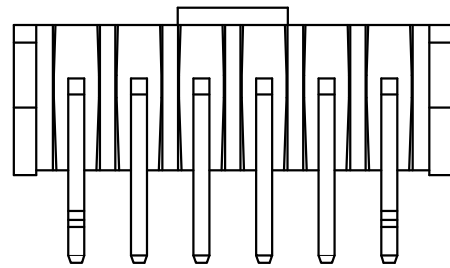

PCB LAYOUT

Circuits	Product name	Dimension mm		Circuits	Product name	Dimension mm	
		A	B			A	B
3	XHDH-3AWF	5.00	10.00	10	XHDH-10AWF	22.50	27.50
4	XHDH-4AWF	7.50	12.50	11	XHDH-11AWF	25.00	30.00
5	XHDH-5AWF	10.00	15.00	12	XHDH-12AWF	27.50	32.50
6	XHDH-6AWF	12.50	17.50	13	XHDH-13AWF	30.00	35.00
7	XHDH-7AWF	15.00	20.00	14	XHDH-14AWF	32.50	37.50
8	XHDH-8AWF	17.50	22.50	-	-	-	-
9	XHDH-9AWF	20.00	25.00	20	XHDH-20AWF	47.5	52.5

GENERAL TOLERANCES (UNLESS SPECIFIED)				ZHE JIANG DELI CONNECTORS CO., LTD			
.X: ±0.25	X°: ±3.0°	PRODUCT NAME: DL25026 (XHDH)-AWF		TITLE: 2.50 mm Pitch Wire To Board Wafer		PART NO:	
.XX: ±0.15	.X°: ±2.0°	DR: Chen Quan Long	DATE: 19/08/01	SCALE: N/A		PAGE: 1/1	
.XXX: ±0.01	.XX°: ±1.0°	CHKD: Wu Hui	DATE: 19/08/01	UNITS: mm		REV.: A	
FINISH:		APPD: Ren An De	DATE: 19/08/01				
DRAWING NO:							

REV.	REVISION DESCRIPTION	DATE	APPD

### NOTES

Available in 02 Circuits.  
 Match with DL25026 series housing  
 Material : Nylon UL94V-0(2).  
 Accepts DL25026-T Crimp Terminal.

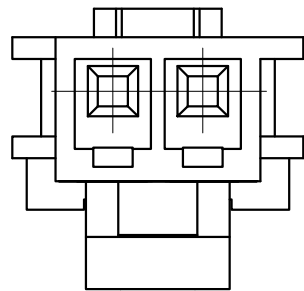
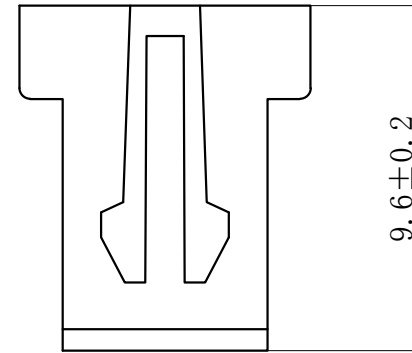
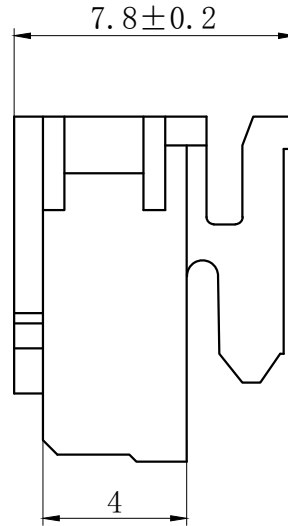
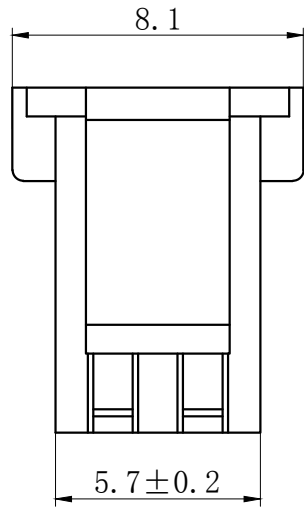
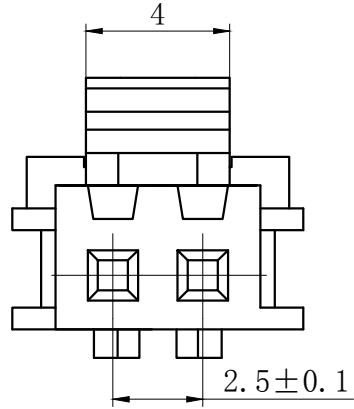

GENERAL TOLERANCES (UNLESS SPECIFIED)		ZHE JIANG DELI CONNECTORS CO., LTD	
.X: ± 0.25	X°: ± 3.0°	PRODUCT NAME: <b>DL25026 (XHDH)-2Y</b>	TITLE: 2.50 mm Pitch Housing
.XX: ± 0.15	.X°: ± 2.0°	DR: Chen Quan Long	DATE: 19/08/01
.XXX: ± 0.01	.XX°: ± 1.0°	CHKD: Wu Hui	DATE: 19/08/01
FINISH:		APPD: Ren An De	DATE: 19/08/01
DRAWING NO:			

A  
B  
C  
D  
E  
F

A  
B  
C  
D  
E  
F

1 2 3 4 5 6 7 8

1 2 3 4 5 6 7 8

REV.	REVISION DESCRIPTION	DATE	APPD

## NOTES

Available in 03 through 20 Circuits.

Match with DL25026 series housing

Material : Nylon UL94V-0(2).

Accepts DL25026-T Crimp Terminal.

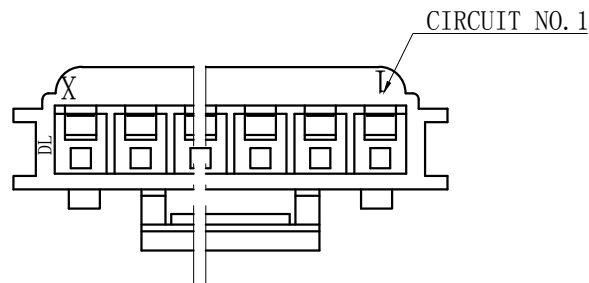
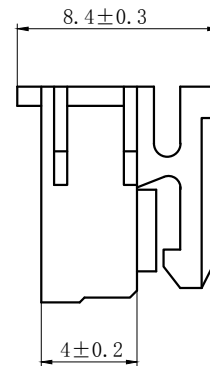
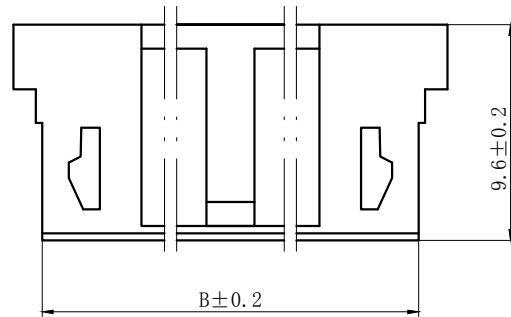
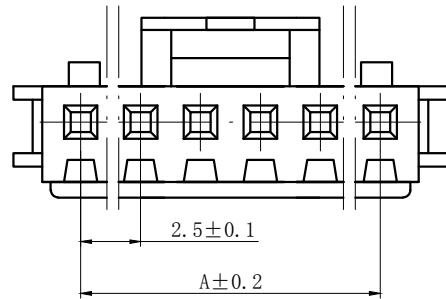

Circuits	Product name	Dimension mm		Circuits	Product name	Dimension mm	
		A	B			A	B
3	XHDH-3Y	5.00	8.20	10	XHDH-10Y	22.50	25.70
4	XHDH-4Y	7.50	10.70	11	XHDH-11Y	25.00	28.20
5	XHDH-5Y	10.00	13.20	12	XHDH-12Y	27.50	30.70
6	XHDH-6Y	12.50	15.70	13	XHDH-13Y	30.00	33.20
7	XHDH-7Y	15.00	18.20	14	XHDH-14Y	32.50	35.70
8	XHDH-8Y	17.50	20.70	-	-	-	-
9	XHDH-9Y	20.00	23.20	20	XHDH-20Y	47.50	50.70

GENERAL TOLERANCES  
(UNLESS SPECIFIED)

.X: ± 0.25	X° : ± 3.0°
.XX: ± 0.15	.X° : ± 2.0°
.XXX: ± 0.01	.XX° : ± 1.0°

FINISH: \_\_\_\_\_

DRAWING NO:



ZHE JIANG DELI CONNECTORS CO., LTD

PRODUCT NAME:  
DL25026 (XHDH)-Y

DR: Chen Quan Long DATE: 19/08/01

CHKD: Wu Hui DATE: 19/08/01

APPD: Ren An De DATE: 19/08/01

TITLE:  
2.50 mm Pitch Housing

PART NO:

SCALE: N/A PAGE: 1/1

UNITS: mm REV.: A

REV.	REVISION DESCRIPTION	DATE	APPD

## NOTES

Available in 02 through 20 Circuits.

Mates with DL25026-Y Series Housing.

Material : Nylon UL94V-0(2).

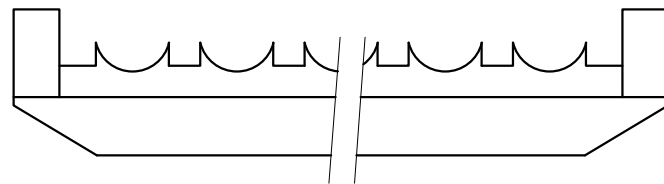
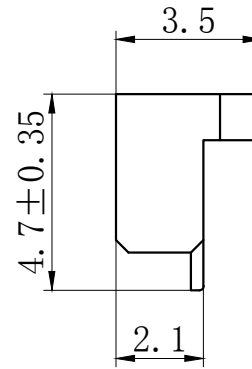
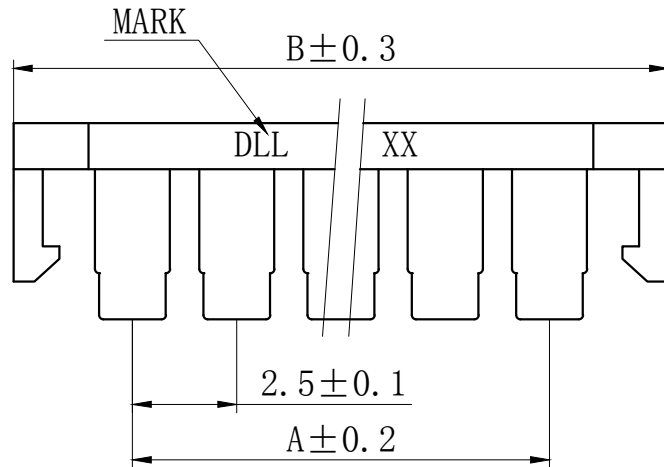
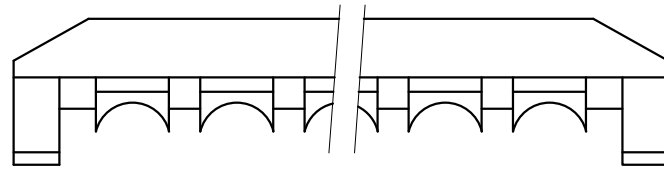

Circuits	Product name	Dimension mm		Circuits	Product name	Dimension mm	
		A	B			A	B
2	XHDH-2S	2.5	8.2	9	XHDH-9S	20.0	25.7
3	XHDH-3S	5.0	10.7	10	XHDH-10S	22.5	28.2
4	XHDH-4S	7.5	13.2	11	XHDH-11S	25.0	30.7
5	XHDH-5S	10.0	15.7	12	XHDH-12S	27.5	33.2
6	XHDH-6S	12.5	18.2	13	XHDH-13S	30.0	35.7
7	XHDH-7S	15.0	20.7	-	-	-	-
8	XHDH-8S	17.5	23.2	20	XHDH-20S	47.5	53.2

GENERAL TOLERANCES (UNLESS SPECIFIED)				ZHE JIANG DELI CONNECTORS CO., LTD			
.X: ±0.25	X°: ±3.0°	PRODUCT NAME: <b>DL25026 (XHDH)-S</b>		TITLE: 2.50 mm Pitch Retainer			
.XX: ±0.15	.X°: ±2.0°	DR: Chen Quan Long		DATE: 19/08/01			
.XXX: ±0.01	.XX°: ±1.0°	CHKD: Wu Hui		DATE: 19/08/01			
FINISH: _____		APPD: Ren An De		DATE: 19/08/01		PART NO:	
DRAWING NO:				SCALE: N/A		PAGE: 1/1	
				UNITS: mm		REV.: B	

REV.	REVISION DESCRIPTION	DATE	APPD

### NOTES

Available in 02 through 20 Circuits.  
 Match with DL25026-Y series housing  
 Material : Nylon UL94V-0(2).  
 Accepts DL25026-RT Crimp Terminal.

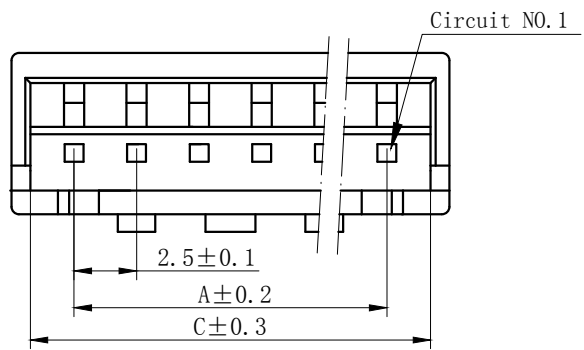
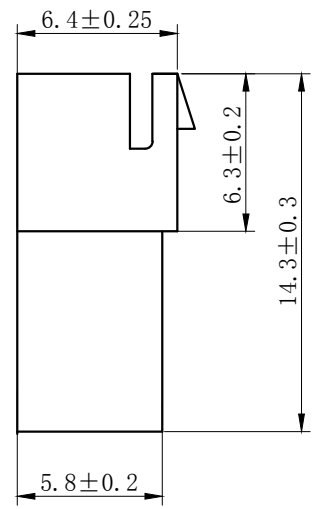
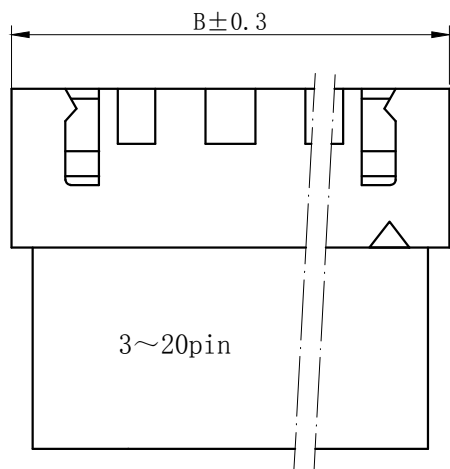
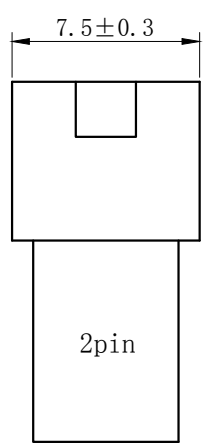
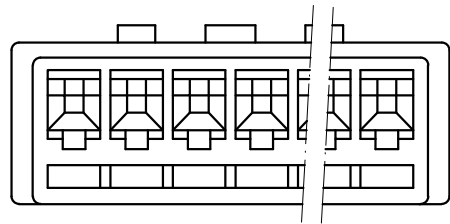

Circuits	Product name	Dimension mm			Circuits	Product name	Dimension mm		
		A	B	C			A	B	C
2	XHDH-2R	2.50	7.50	6.00	10	XHDH-10R	22.50	27.50	26.00
3	XHDH-3R	5.00	10.00	8.50	11	XHDH-11R	25.00	30.00	28.50
4	XHDH-4R	7.50	12.50	11.00	12	XHDH-12R	27.50	32.50	31.00
5	XHDH-5R	10.00	15.00	13.50	13	XHDH-13R	30.00	35.00	33.50
6	XHDH-6R	12.50	17.50	16.00	14	XHDH-14R	32.50	37.50	36.00
7	XHDH-7R	15.00	20.00	18.50	15	XHDH-15R	35.00	40.00	38.50
8	XHDH-8R	17.50	22.50	21.00	-	-	-	-	-
9	XHDH-9R	20.00	25.00	23.50	20	XHDH-20R	47.50	52.50	51.00

GENERAL TOLERANCES (UNLESS SPECIFIED)		ZHE JIANG DELI CONNECTORS CO., LTD			
.X: ± 0.25	X°: ± 3.0°	PRODUCT NAME: DL25026 (XHDH)-R		TITLE: 2.50 mm Pitch Wire To Wire Housing	
.XX: ± 0.15	.X°: ± 2.0°	DR: Chen Quan Long		DATE: 20/12/30	
.XXX: ± 0.01	.XX°: ± 1.0°	CHKD: Wu Hui		DATE: 20/12/30	
DRAWING NO:		APPD: Ren An De		DATE: 20/12/30	
FINISH:		SCALE: N/A		PAGE: 1/1	
		UNITS: mm		REV.: A	



REV.	REVISION DESCRIPTION	DATE	APPD

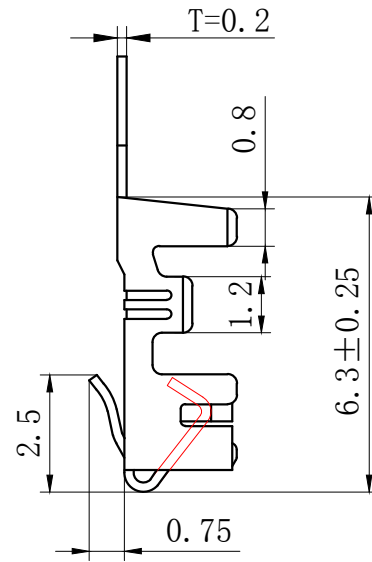
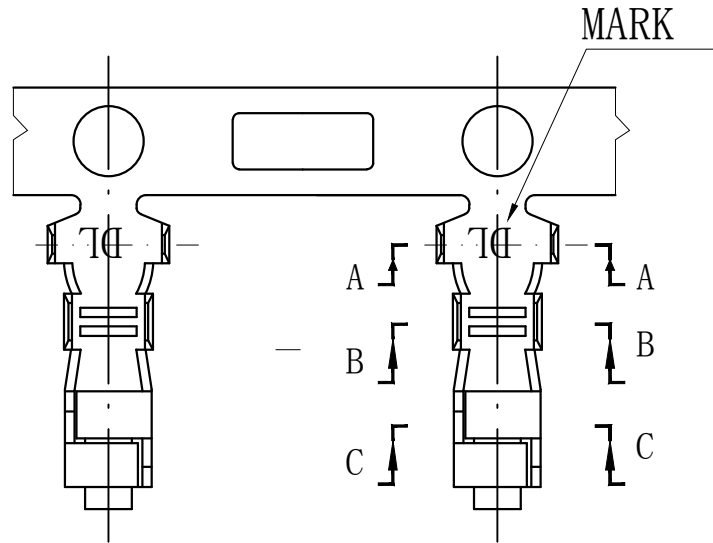

## NOTES

Used in DL25001-Y Series Housing.  
Accepts AWG #28~22 Wire Range.

0.08~ 0.33 mm<sup>2</sup> .

Insulation O.D.=1.2~1.9 mm.

Material : Phosphor Bronze .

Finish: Tin plated.

Thickness: 0.2 mm.

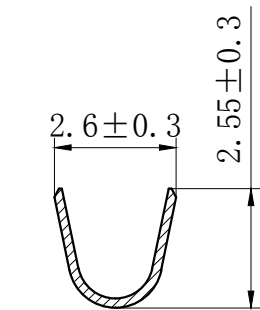



SECTION A-A

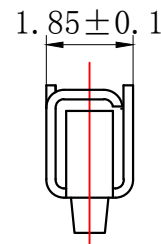

SECTION B-B



SECTION C-C

GENERAL TOLERANCES (UNLESS SPECIFIED)		ZHE JIANG DELI CONNECTORS CO., LTD	
.X: ± 0.25	X° : ± 3.0°	PRODUCT NAME: <b>DL25001 (TJC3)-T</b>	TITLE: 2.50 mm Pitch Crimp Terminal
.XX: ± 0.15	.X° : ± 2.0°	DR: Chen Quan Long	DATE: 19/08/01
.XXX: ± 0.01	.XX° : ± 1.0°	CHKD: Wu Hui	DATE: 19/08/01
FINISH: _____	 	APPD: Ren An De	DATE: 19/08/01
DRAWING NO:			

REV.	REVISION DESCRIPTION	DATE	APPD



### NOTES

Used in DL25001-Y Series Housing.  
 Accepts AWG #24~20 Wire Range.  
 Material : Phosphor Bronze .  
 Finish: Tin plated.  
 Thickness: 0.2 mm.

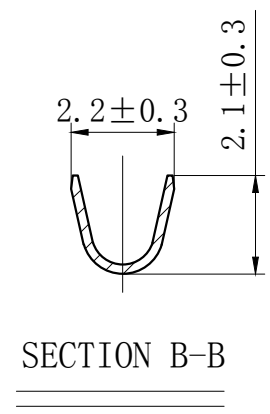

GENERAL TOLERANCES (UNLESS SPECIFIED)				ZHE JIANG DELI CONNECTORS CO., LTD			
.X: ± 0.25	X° : ± 3.0°	PRODUCT NAME: <b>DL25001(TJC3)-T-G</b>		TITLE: 2.50 mm Pitch Crimp Terminal		PART NO:	
.XX: ± 0.15	.X° : ± 2.0°	DR: Chen Quan Long	DATE: 19/08/01	SCALE: N/A		PAGE: 1/1	
.XXX: ± 0.01	.XX° : ± 1.0°	CHKD: Wu Hui	DATE: 19/08/01	UNITS: mm		REV.: A	
DRAWING NO:		APPD: Ren An De	DATE: 19/08/01				

REV.	REVISION DESCRIPTION	DATE	APPD

### NOTES

Used in DL25002-R Series Housing.  
Accepts AWG #28~22 Wire Range.

0.08~ 0.33 mm<sup>2</sup> .

Insulation O.D. =1.2~1.9 mm.

Material : Phosphor Bronze .

Finish: Tin plated.

Thickness: 0.2 mm.

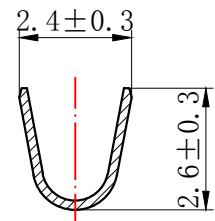
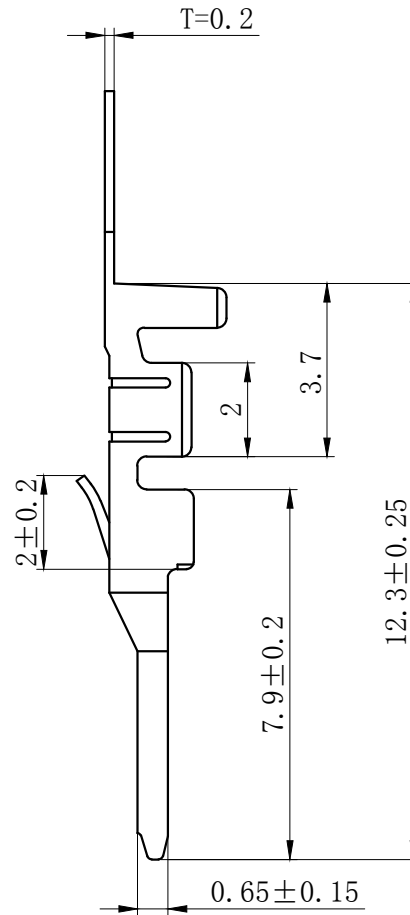
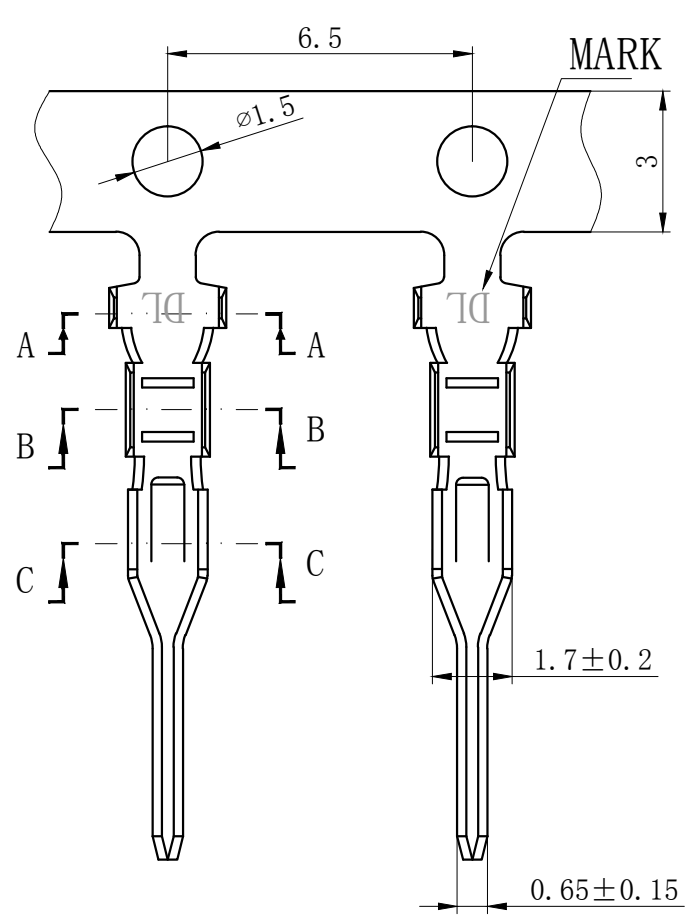

SECTION A-A

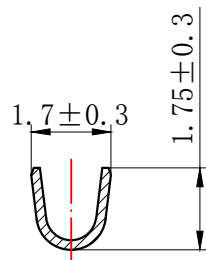

SECTION B-B

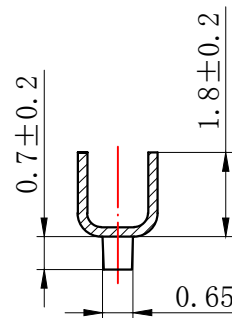

SECTION C-C

GENERAL TOLERANCES (UNLESS SPECIFIED)				ZHE JIANG DELI CONNECTORS CO., LTD			
.X: ± 0.25	X°: ± 3.0°	PRODUCT NAME: DL25002 (TJC3B)-RT		TITLE: 2.50 mm Pitch Wire To Wire Terminal		PART NO:	
.XX: ± 0.15	.X°: ± 2.0°	DR: Chen Quan Long	DATE: 20/12/30	SCALE: N/A		PAGE: 1/1	
.XXX: ± 0.01	.XX°: ± 1.0°	CHKD: Wu Hui	DATE: 20/12/30	UNITS: mm		REV.: A	
DRAWING NO:		APPD: Ren An De	DATE: 20/12/30				

## X-ON Electronics

Largest Supplier of Electrical and Electronic Components

*Click to view similar products for [Headers & Wire Housings](#) category:*

*Click to view products by [DLL](#) manufacturer:*

Other Similar products are found below :

[0015917161](#) [0022155065](#) [57102-F02-18ULF](#) [58102-G61-06LF](#) [582553-1](#) [01.001.5753.1](#) [0050291907](#) [02.125.8002.8](#) [609-3404](#) [61062-3](#)  
[CSU011177004](#) [622-0430](#) [622-3653LF](#) [63453-116](#) [636-1030](#) [636-1427](#) [636-3427](#) [636-4007](#) [641938-9](#) [65495-038](#) [65692-001LF](#) [65781-018](#)  
[65781-047](#) [65817-010LF](#) [65817-015LF](#) [67095-007LF](#) [67601157](#) [68631-112](#) [68645-018](#) [699319-000](#) [70.362.1628.0](#) [70-4210](#) [70-4226B](#) [70-](#)  
[4853B](#) [71.350.2428.0](#) [733-134](#) [733-162](#) [760-3052](#) [MHR-64-VUAL](#) [80.063.4001.1](#) [800-90-001-10-001000](#) [801-43-002-10-013000](#)  
[801-43-006-10-002000](#) [803-43-024-10-001000](#) [803-93-012-10-001000](#) [8-1437020-4](#) [819-22-004-30-001101](#) [820-22-006-30-001101](#)  
[820-22-008-30-001101](#) [821-22-002-10-001101](#)