

技术特性/Specifications:

额定电压 Rated voltage: 100V AC, DC
额定电流 Rated current: 1A AC, DC
接触电阻 Contact resistance: 20m Ω max
绝缘电阻 Insulation resistance: 500M Ω min
耐压 Withstand voltage: 500V AC/minute
环境温度 Ambient temperature: -40 $^{\circ}$ C~+105 $^{\circ}$ C
适用线规 Wire range: AWG#30~#26

1 2 3 4 5 6 7 8

| REV. | REVISION DESCRIPTION | DATE |
|------|----------------------|------|
| | | |

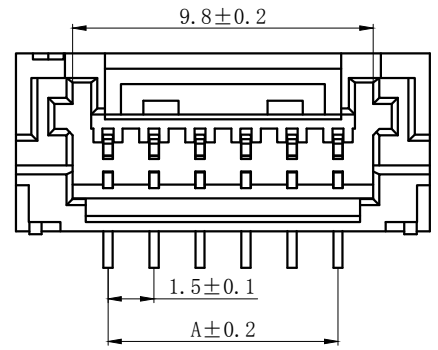
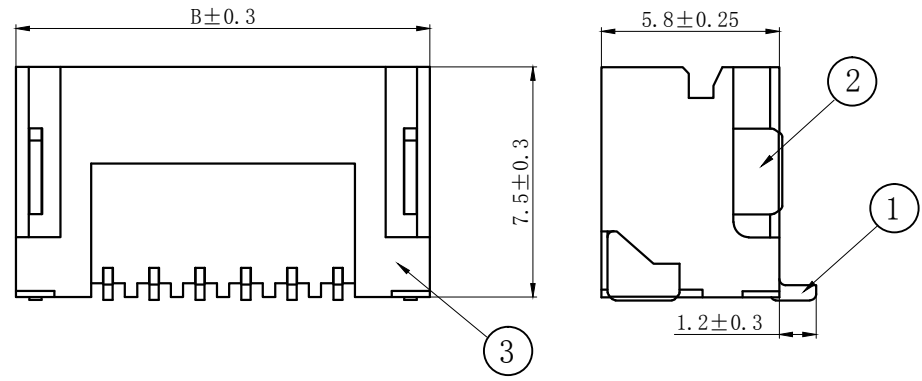

NOTES

Available in 02 through 15 Circuits.
 Mates with DL15005-Y Series Housing.
 Material : LCP UL94V-0.
 Pin Material : Phosphor bronze.
 Tin-plated .
 Welding Material : Brass.
 Tin-plated .

| | | | | | |
|----|----|-----|-----|----|---------|
| 3 | ③ | 基座 | LCP | 1 | UL94V-0 |
| 2 | ② | 焊片 | 黄铜 | 2 | 镀锡 |
| 1 | ① | 接触件 | 磷青铜 | N* | 镀锡 |
| 序号 | 图号 | 名称 | 材料 | 数量 | 附件 |

| Circuits | Type | Dimension mm | | | Circuits | Type | Dimension mm | | |
|----------|---------|--------------|-------|-------|----------|----------|--------------|-------|-------|
| | | A | B | C | | | A | B | C |
| 2 | ZHB-2AB | 1.50 | 7.50 | 3.80 | 10 | ZHB-10AB | 13.50 | 19.50 | 15.80 |
| 3 | ZHB-3AB | 3.00 | 9.00 | 5.30 | 11 | ZHB-11AB | 15.00 | 21.00 | 17.30 |
| 4 | ZHB-4AB | 4.50 | 10.50 | 6.80 | 12 | ZHB-12AB | 16.50 | 22.50 | 18.80 |
| 5 | ZHB-5AB | 6.00 | 12.00 | 8.30 | 13 | ZHB-13AB | 18.00 | 24.00 | 20.30 |
| 6 | ZHB-6AB | 7.50 | 13.50 | 9.80 | 14 | ZHB-14AB | 19.50 | 25.50 | 21.80 |
| 7 | ZHB-7AB | 9.00 | 15.00 | 11.30 | 15 | ZHB-15AB | 21.00 | 27.00 | 23.30 |
| 8 | ZHB-8AB | 10.50 | 16.50 | 12.80 | - | - | - | - | - |
| 9 | ZHB-9AB | 12.00 | 18.00 | 14.30 | - | - | - | - | - |

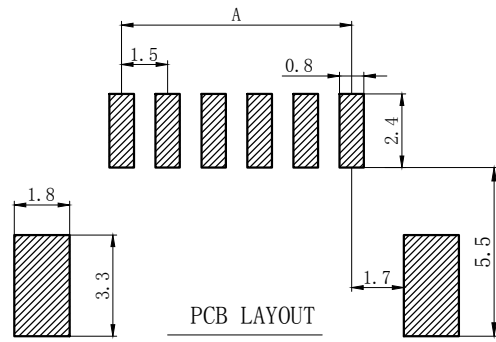

PCB LAYOUT

| | | | | | |
|---------------------------------------|--------------|------------------------------------|----------------|---|---------|
| GENERAL TOLERANCES (UNLESS SPECIFIED) | | ZHE JIANG DELI CONNECTORS CO., LTD | | | |
| .X: ± 0.25 | X°: ± 3.0° | PRODUCT NAME: | | TITLE: 1.5 mm Pitch Wire To Board Wafer | |
| .XX: ± 0.15 | .X°: ± 2.0° | DL15005 (ZHB)-AB | | PART NO: | |
| .XXX: ± 0.01 | .XX°: ± 1.0° | DR: Yuan Jun Rong | DATE: 21/03/06 | SCALE: N/A PAGE: 1/1 | |
| FINISH: | | CHKD: Wu Hui | DATE: 21/03/06 | UNITS: mm | REV.: A |
| DRAWING NO: | | APPD: Ren An De | DATE: 21/03/06 | | |

1 2 3 4 5 6 7 8

| | | | |
|------|----------------------|------|--|
| REV. | REVISION DESCRIPTION | DATE | |
| | | | |

NOTES

Available in 02 through 15 Circuits.
Mates with DL15005-Y Series Housing.
Material : LCP UL94V-0.
Pin Material : Phosphor bronze.
 Tin-plated .
Welding Material : Brass.
 Tin-plated .

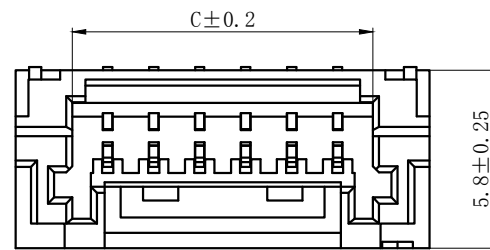
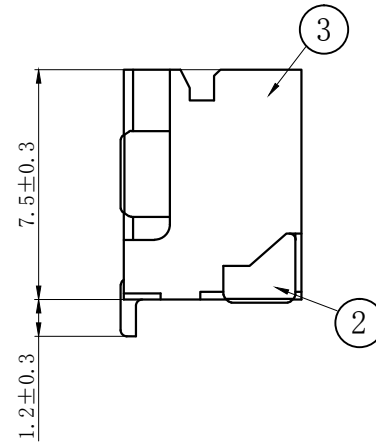
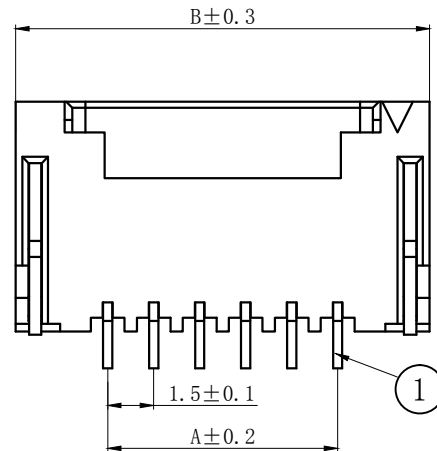

| | | | | | |
|----|----|-----|-----|----|---------|
| 3 | ③ | 基座 | LCP | 1 | UL94V-0 |
| 2 | ② | 焊片 | 黄铜 | 2 | 镀锡 |
| 1 | ① | 接触件 | 磷青铜 | N* | 镀锡 |
| 序号 | 图号 | 名称 | 材料 | 数量 | 附件 |

| Circuits | Type | Dimension mm | | | Circuits | Type | Dimension mm | | |
|----------|----------|--------------|-------|-------|----------|-----------|--------------|-------|-------|
| | | A | B | C | | | A | B | C |
| 2 | ZHB-2AWB | 1.50 | 7.50 | 3.80 | 10 | ZHB-10AWB | 13.50 | 19.50 | 15.80 |
| 3 | ZHB-3AWB | 3.00 | 9.00 | 5.30 | 11 | ZHB-11AWB | 15.00 | 21.00 | 17.30 |
| 4 | ZHB-4AWB | 4.50 | 10.50 | 6.80 | 12 | ZHB-12AWB | 16.50 | 22.50 | 18.80 |
| 5 | ZHB-5AWB | 6.00 | 12.00 | 8.30 | 13 | ZHB-13AWB | 18.00 | 24.00 | 20.30 |
| 6 | ZHB-6AWB | 7.50 | 13.50 | 9.80 | 14 | ZHB-14AWB | 19.50 | 25.50 | 21.80 |
| 7 | ZHB-7AWB | 9.00 | 15.00 | 11.30 | 15 | ZHB-15AWB | 21.00 | 27.00 | 23.30 |
| 8 | ZHB-8AWB | 10.50 | 16.50 | 12.80 | - | - | - | - | - |
| 9 | ZHB-9AWB | 12.00 | 18.00 | 14.30 | - | - | - | - | - |

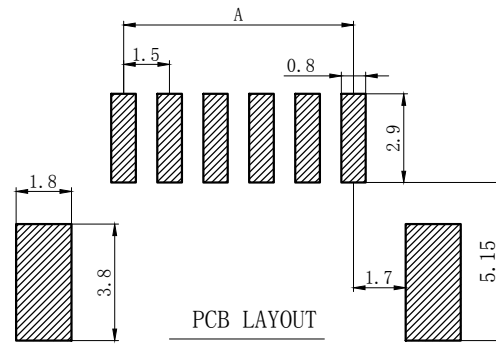

| GENERAL TOLERANCES (UNLESS SPECIFIED) | | ZHE JIANG DELI CONNECTORS CO., LTD | |
|---------------------------------------|---------------|------------------------------------|---|
| .X: ± 0.25 | .X°: ± 3.0° | PRODUCT NAME: | TITLE: 1.5 mm Pitch Wire To Board Wafer |
| .XX: ± 0.15 | .XX°: ± 2.0° | DL15005 (ZHB)-AWB | |
| .XXX: ± 0.01 | .XXX°: ± 1.0° | DR: Yuan Jun Rong | DATE: 21/03/06 |
| FINISH: | | CHKD: Wu Hui | DATE: 21/03/06 |
| DRAWING NO: | | APPD: Ren An De | DATE: 21/03/06 |
| | | SCALE: N/A | PAGE: 1/1 |
| | | UNITS: mm | REV.: A |

| REV. | REVISION DESCRIPTION | DATE | APPD |
|------|----------------------|------|------|
| | | | |

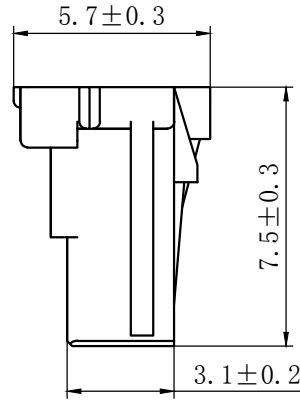
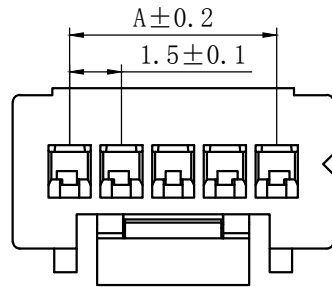
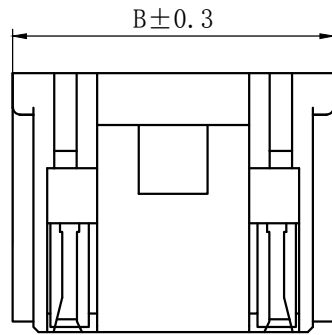
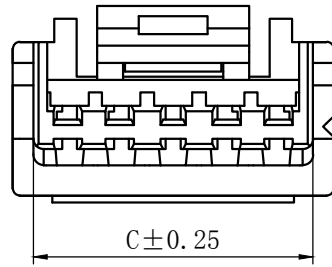

NOTES

Available in 02 through 16 Circuits.

Mates with DL15005 Series WAFER.

Material : Nylon UL94V-0(2).

Accepts DL15005-T Crimp Terminal.

| Circuits | Type | Dimension mm | | | Circuits | Type | Dimension mm | | |
|----------|--------|--------------|-------|-------|----------|---------|--------------|-------|-------|
| | | A | B | C | | | A | B | C |
| 2 | ZHB-2Y | 1.50 | 4.80 | 3.60 | 10 | ZHB-10Y | 13.50 | 16.80 | 15.60 |
| 3 | ZHB-3Y | 3.00 | 6.30 | 5.10 | 11 | ZHB-11Y | 15.00 | 18.30 | 17.10 |
| 4 | ZHB-4Y | 4.50 | 7.80 | 6.60 | 12 | ZHB-12Y | 16.50 | 19.80 | 18.60 |
| 5 | ZHB-5Y | 6.00 | 9.30 | 8.10 | 13 | ZHB-13Y | 18.00 | 21.30 | 20.10 |
| 6 | ZHB-6Y | 7.50 | 10.80 | 9.60 | 14 | ZHB-14Y | 19.50 | 22.80 | 21.60 |
| 7 | ZHB-7Y | 9.00 | 12.30 | 11.10 | 15 | ZHB-15Y | 21.00 | 24.30 | 23.10 |
| 8 | ZHB-8Y | 10.50 | 13.80 | 12.60 | 16 | ZHB-16Y | 22.50 | 25.80 | 24.60 |
| 9 | ZHB-9Y | 12.00 | 15.30 | 14.10 | — | — | — | — | — |

| GENERAL TOLERANCES (UNLESS SPECIFIED) | | ZHE JIANG DELI CONNECTORS CO ., LTD | |
|--|---------------|-------------------------------------|--|
| .X: ± 0.25 | X° : ± 3.0° | PRODUCT NAME: | TITLE: |
| .XX: ± 0.15 | .X° : ± 2.0° | DL15005 (ZHB)-Y | 1.50 mm Pitch Wire To Board Housing |
| .XXX: ± 0.01 | .XX° : ± 1.0° | DR:Yuan Jun Rong | DATE:21/06/01 |
| FINISH: | | CHKD: Wu Hui | DATE:21/06/01 |
| DRAWING NO: | | APPD:Ren An De | DATE:21/06/01 |
| | | | PART NO: |
| | | | SCALE: N/A |
| | | | PAGE: 1/1 |
| | | | UNITS: mm |
| | | | REV.: A |

| REV. | REVISION DESCRIPTION | DATE | APPD |
|------|----------------------|------|------|
| | | | |

NOTES

Used in DL15005-Y Series Housing.
 Accepts AWG #30~26 Wire Range.
 0.05~ 0.13 mm² .
 Insulation O.D.=0.76~1.0 mm.
 Material : Phosphor Bronze .
 Finish: Tin Plating
 Thickness: 0.15 mm.

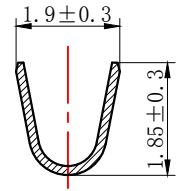
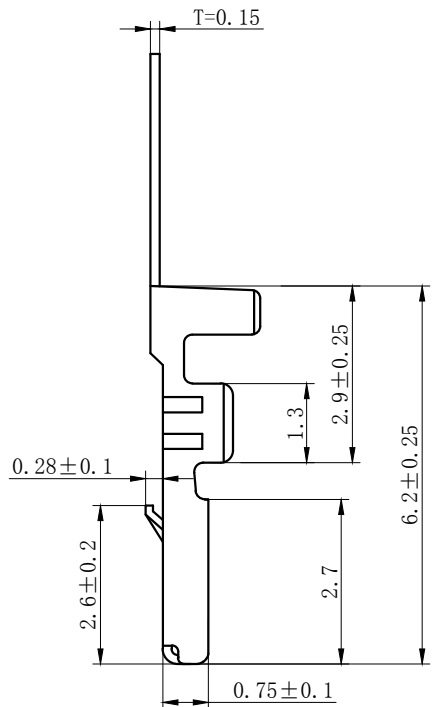
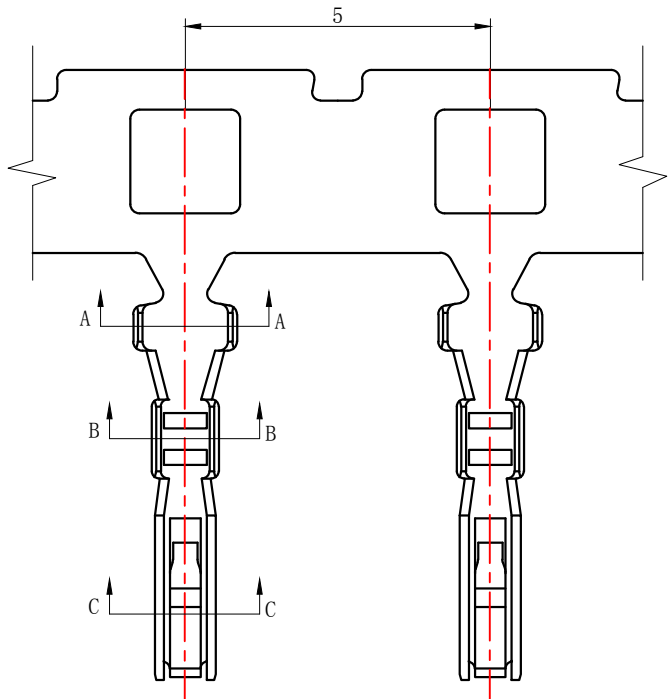

SECTION A-A

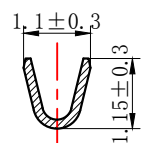

SECTION B-B

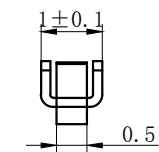

SECTION C-C

| | | | |
|--|---------------|--|--|
| GENERAL TOLERANCES (UNLESS SPECIFIED) | | ZHE JIANG DELI CONNECTORS CO .,LTD | |
| .X: ± 0.25 | X° : ± 3.0° | PRODUCT NAME: DL15005(ZHB)-T | TITLE: 1.5 mm Pitch Wire To Board Crimp Terminal |
| .XX: ± 0.15 | .X° : ± 2.0° | DR:Chen Quan Long | DATE:21/06/01 |
| .XXX: ± 0.01 | .XX° : ± 1.0° | CHKD: Wu Hui | DATE:21/06/01 |
| FINISH: _____ | | APPD:Ren An De | DATE:21/06/01 |
| DRAWING NO: | | SCALE: N/A | PAGE: 1/1 |
| | | UNITS: mm | REV.: A |

X-ON Electronics

Largest Supplier of Electrical and Electronic Components

Click to view similar products for [Headers & Wire Housings](#) category:

Click to view products by [DLL](#) manufacturer:

Other Similar products are found below :

[0015917161](#) [0022155065](#) [57102-F02-18ULF](#) [58102-G61-06LF](#) [582553-1](#) [01.001.5753.1](#) [0050291907](#) [02.125.8002.8](#) [609-3404](#) [61062-3](#)
[CSU011177004](#) [622-0430](#) [622-3653LF](#) [63453-116](#) [636-1030](#) [636-1427](#) [636-3427](#) [636-4007](#) [641938-9](#) [65495-038](#) [65692-001LF](#) [65781-018](#)
[65781-047](#) [65817-010LF](#) [65817-015LF](#) [67095-007LF](#) [67601157](#) [68631-112](#) [68645-018](#) [699319-000](#) [70.362.1628.0](#) [70-4210](#) [70-4226B](#) [70-](#)
[4853B](#) [71.350.2428.0](#) [733-134](#) [733-162](#) [760-3052](#) [MHR-64-VUAL](#) [80.063.4001.1](#) [800-90-001-10-001000](#) [801-43-002-10-013000](#)
[801-43-006-10-002000](#) [803-43-024-10-001000](#) [803-93-012-10-001000](#) [8-1437020-4](#) [819-22-004-30-001101](#) [820-22-006-30-001101](#)
[820-22-008-30-001101](#) [821-22-002-10-001101](#)