

**技术特性/Specifications:**

额定电压 Rated voltage: 100V AC, DC  
额定电流 Rated current: 1A AC, DC  
接触电阻 Contact resistance: 20m $\Omega$  max  
绝缘电阻 Insulation resistance: 500M $\Omega$  min  
耐压 Withstand voltage: 500V AC/minute  
环境温度 Ambient temperature: -40 $^{\circ}$ C~+105 $^{\circ}$ C  
适用线规 Wire range: AWG#30~#26

REV.	REVISION DESCRIPTION	DATE

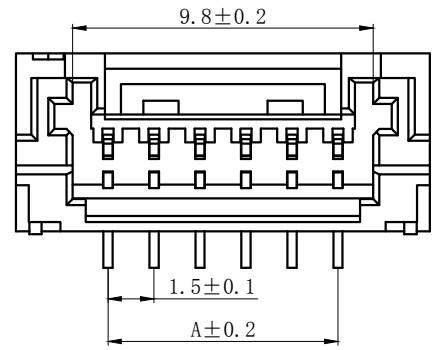
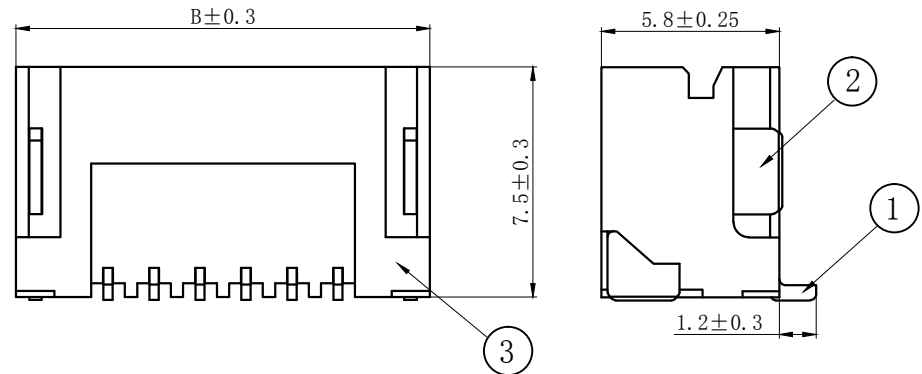

NOTES

Available in 02 through 15 Circuits.  
 Mates with DL15005-Y Series Housing.  
 Material : LCP UL94V-0.  
 Pin Material : Phosphor bronze.  
                                     Tin-plated .  
 Welding Material : Brass.  
   Tin-plated .

3	③	底座	LCP	1	UL94V-0
2	②	焊片	黄铜	2	镀锡
1	①	接触件	磷青铜	N*	镀锡
序号	图号	名称	材料	数量	附件

Circuits	Type	Dimension mm			Circuits	Type	Dimension mm		
		A	B	C			A	B	C
2	ZHB-2AB	1.50	7.50	3.80	10	ZHB-10AB	13.50	19.50	15.80
3	ZHB-3AB	3.00	9.00	5.30	11	ZHB-11AB	15.00	21.00	17.30
4	ZHB-4AB	4.50	10.50	6.80	12	ZHB-12AB	16.50	22.50	18.80
5	ZHB-5AB	6.00	12.00	8.30	13	ZHB-13AB	18.00	24.00	20.30
6	ZHB-6AB	7.50	13.50	9.80	14	ZHB-14AB	19.50	25.50	21.80
7	ZHB-7AB	9.00	15.00	11.30	15	ZHB-15AB	21.00	27.00	23.30
8	ZHB-8AB	10.50	16.50	12.80	-	-	-	-	-
9	ZHB-9AB	12.00	18.00	14.30	-	-	-	-	-

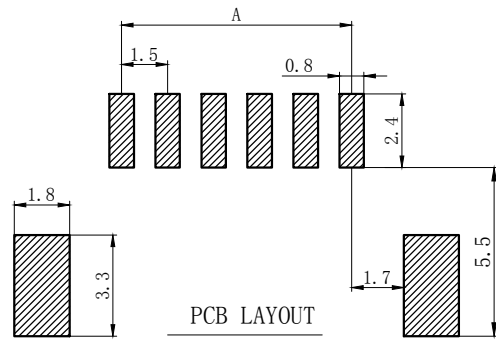

GENERAL TOLERANCES (UNLESS SPECIFIED)		ZHE JIANG DELI CONNECTORS CO., LTD			
.X: ± 0.25	X°: ± 3.0°	PRODUCT NAME:		TITLE: 1.5 mm Pitch Wire To Board Wafer	
.XX: ± 0.15	.X°: ± 2.0°	DL15005(ZHB)-AB		PART NO:	
.XXX: ± 0.01	.XX°: ± 1.0°	DR: Yuan Jun Rong	DATE: 21/03/06	SCALE: N/A PAGE: 1/1	
FINISH:		CHKD: Wu Hui	DATE: 21/03/06	UNITS: mm REV.: A	
DRAWING NO:		APPD: Ren An De	DATE: 21/03/06		

REV.	REVISION DESCRIPTION	DATE

A  
B  
C  
D  
E  
F

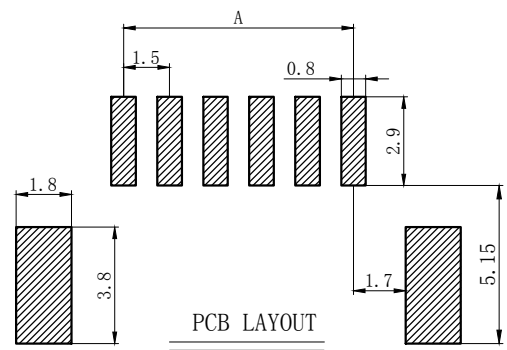
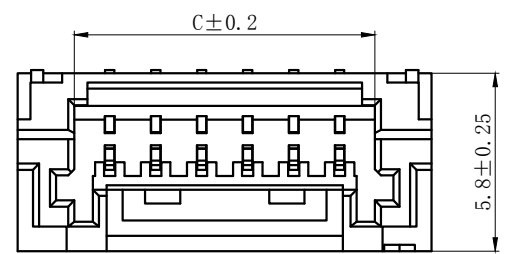
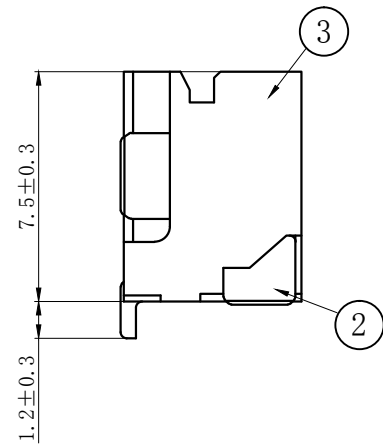
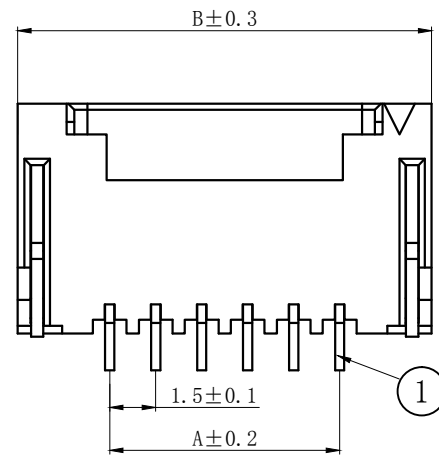

### NOTES

Available in 02 through 15 Circuits.  
 Mates with DL15005-Y Series Housing.  
 Material : LCP UL94V-0.  
 Pin Material : Phosphor bronze.  
 Tin-plated .  
 Welding Material : Brass.  
 Tin-plated .

3	③	基座	LCP	1	UL94V-0
2	②	焊片	黄铜	2	镀锡
1	①	接触件	磷青铜	N*	镀锡
序号	图号	名称	材料	数量	附件

Circuits	Type	Dimension mm			Circuits	Type	Dimension mm		
		A	B	C			A	B	C
2	ZHB-2AWB	1.50	7.50	3.80	10	ZHB-10AWB	13.50	19.50	15.80
3	ZHB-3AWB	3.00	9.00	5.30	11	ZHB-11AWB	15.00	21.00	17.30
4	ZHB-4AWB	4.50	10.50	6.80	12	ZHB-12AWB	16.50	22.50	18.80
5	ZHB-5AWB	6.00	12.00	8.30	13	ZHB-13AWB	18.00	24.00	20.30
6	ZHB-6AWB	7.50	13.50	9.80	14	ZHB-14AWB	19.50	25.50	21.80
7	ZHB-7AWB	9.00	15.00	11.30	15	ZHB-15AWB	21.00	27.00	23.30
8	ZHB-8AWB	10.50	16.50	12.80	-	-	-	-	-
9	ZHB-9AWB	12.00	18.00	14.30	-	-	-	-	-

GENERAL TOLERANCES (UNLESS SPECIFIED)		ZHE JIANG DELI CONNECTORS CO., LTD			
.X: ± 0.25	.X°: ± 3.0°	PRODUCT NAME: DL15005 (ZHB)-AWB		TITLE: 1.5 mm Pitch Wire To Board Wafer	
.XX: ± 0.15	.XX°: ± 2.0°	DR: Yuan Jun Rong	DATE: 21/03/06	PART NO:	
.XXX: ± 0.01	.XXX°: ± 1.0°	CHKD: Wu Hui	DATE: 21/03/06	SCALE: N/A	PAGE: 1/1
DRAWING NO:		APPD: Ren An De	DATE: 21/03/06	UNITS: mm	REV.: A

REV.	REVISION DESCRIPTION	DATE	APPD

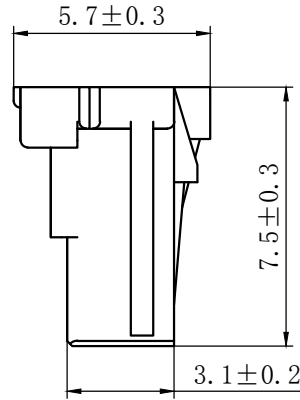
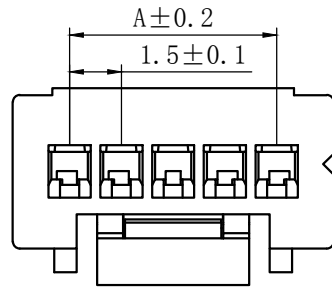
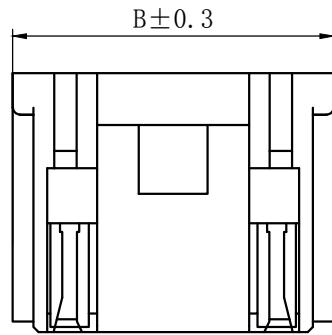
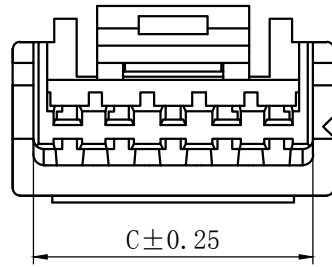

## NOTES

Available in 02 through 16 Circuits.

Mates with DL15005 Series WAFER.

Material : Nylon UL94V-0(2).

Accepts DL15005-T Crimp Terminal.

Circuits	Type	Dimension mm			Circuits	Type	Dimension mm		
		A	B	C			A	B	C
2	ZHB-2Y	1.50	4.80	3.60	10	ZHB-10Y	13.50	16.80	15.60
3	ZHB-3Y	3.00	6.30	5.10	11	ZHB-11Y	15.00	18.30	17.10
4	ZHB-4Y	4.50	7.80	6.60	12	ZHB-12Y	16.50	19.80	18.60
5	ZHB-5Y	6.00	9.30	8.10	13	ZHB-13Y	18.00	21.30	20.10
6	ZHB-6Y	7.50	10.80	9.60	14	ZHB-14Y	19.50	22.80	21.60
7	ZHB-7Y	9.00	12.30	11.10	15	ZHB-15Y	21.00	24.30	23.10
8	ZHB-8Y	10.50	13.80	12.60	16	ZHB-16Y	22.50	25.80	24.60
9	ZHB-9Y	12.00	15.30	14.10	—	—	—	—	—

GENERAL TOLERANCES (UNLESS SPECIFIED)		ZHE JIANG DELI CONNECTORS CO ., LTD			
.X: ± 0.25	X° : ± 3.0°	PRODUCT NAME:		TITLE:	
.XX: ± 0.15	.X° : ± 2.0°	DL15005 (ZHB)-Y		1.50 mm Pitch Wire To Board Housing	
.XXX: ± 0.01	.XX° : ± 1.0°	DR: Yuan Jun Rong	DATE: 21/06/01	PART NO:	
FINISH:		CHKD: Wu Hui	DATE: 21/06/01	SCALE: N/A	PAGE: 1/1
DRAWING NO:		APPD: Ren An De	DATE: 21/06/01	UNITS: mm	REV.: A

REV.	REVISION DESCRIPTION	DATE	APPD

# NOTES

Used in DL15005-Y Series Housing.  
 Accepts AWG #30~26 Wire Range.  
 0.05~ 0.13 mm<sup>2</sup> .  
 Insulation O.D.=0.76~1.0 mm.  
 Material : Phosphor Bronze .  
 Finish: Tin Plating  
 Thickness: 0.15 mm.

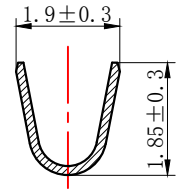
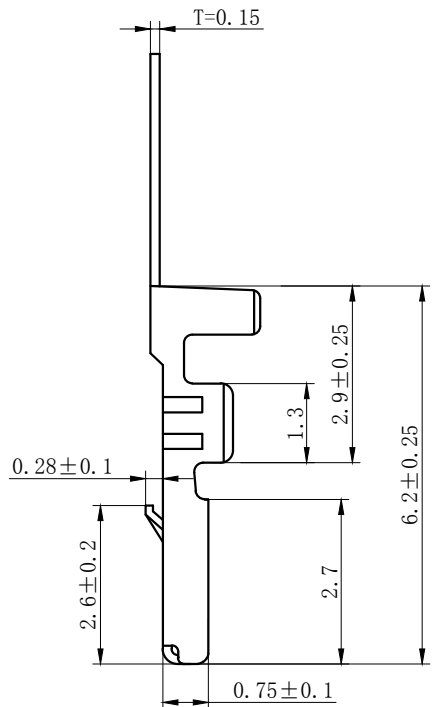
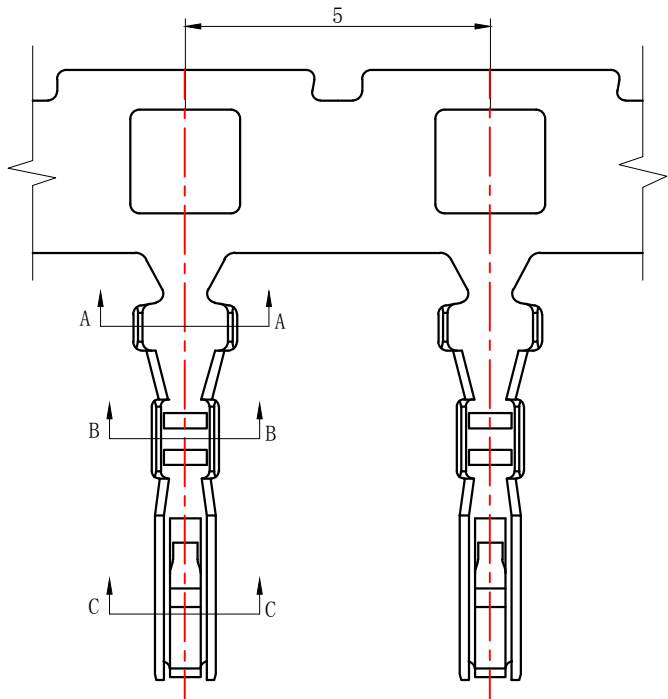

SECTION A-A

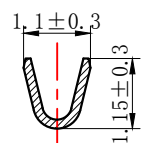

SECTION B-B

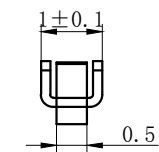

SECTION C-C

GENERAL TOLERANCES (UNLESS SPECIFIED)		ZHE JIANG DELI CONNECTORS CO., LTD	
.X: ± 0.25	X° : ± 3.0°	PRODUCT NAME: <b>DL15005(ZHB)-T</b>	TITLE: 1.5 mm Pitch Wire To Board Crimp Terminal
.XX: ± 0.15	.X° : ± 2.0°	DR:Chen Quan Long	DATE:21/06/01
.XXX: ± 0.01	.XX° : ± 1.0°	CHKD: Wu Hui	DATE:21/06/01
FINISH: _____		APPD:Ren An De	DATE:21/06/01
DRAWING NO:		SCALE: N/A	PAGE: 1/1
		UNITS: mm	REV.: A

## X-ON Electronics

Largest Supplier of Electrical and Electronic Components

*Click to view similar products for [Headers & Wire Housings](#) category:*

*Click to view products by [DLL](#) manufacturer:*

Other Similar products are found below :

[0015917161](#) [0022155065](#) [57102-F02-18ULF](#) [58102-G61-06LF](#) [582553-1](#) [01.001.5753.1](#) [0050291907](#) [02.125.8002.8](#) [609-3404](#) [61062-3](#)  
[CSU011177004](#) [622-0430](#) [622-3653LF](#) [63453-116](#) [636-1030](#) [636-1427](#) [636-3427](#) [636-4007](#) [641938-9](#) [65495-038](#) [65692-001LF](#) [65781-018](#)  
[65781-047](#) [65817-010LF](#) [65817-015LF](#) [67095-007LF](#) [67601157](#) [68631-112](#) [68645-018](#) [699319-000](#) [70.362.1628.0](#) [70-4210](#) [70-4226B](#) [70-](#)  
[4853B](#) [71.350.2428.0](#) [733-134](#) [733-162](#) [760-3052](#) [MHR-64-VUAL](#) [80.063.4001.1](#) [800-90-001-10-001000](#) [801-43-002-10-013000](#)  
[801-43-006-10-002000](#) [803-43-024-10-001000](#) [803-93-012-10-001000](#) [8-1437020-4](#) [819-22-004-30-001101](#) [820-22-006-30-001101](#)  
[820-22-008-30-001101](#) [821-22-002-10-001101](#)