

Surge arrester

2-Electrode arrester

Series/Type: DG401A

Customer:

Version/Date: Issue 02/2015-9-9

Surge arrester

2-Electrode arrester

DG401A

Features	Applications
<ul style="list-style-type: none"> ● Extremely small size ● Extremely fast response time ● Excellent SMD handling ● Stable performance over life ● Very low capacitance ● High insulation resistance ● RoHS-compatible ● UL-identification, No:E311500 	<ul style="list-style-type: none"> ● Splitter ● PCI Cards ● Morden ● Line cards

Electrical specifications

DC breakdown voltage ^{2) 3)} —Circuit current less than 2mA	400 ±20	V %
Impulse breakdown voltage ¹⁾ at 1kv/us -Typical values of distribution	≤900	V
Insulation resistance at DC 100V	≥1	GΩ
Capacitance at 1MHz ²⁾	≤1	Pf
Service life ²⁾		
10 operations 8/20us	1	KA
10 operations 50Hz	1	A
Weight	~1	g
Storage and operations temperature	-40...+90	°C
Climatic category (GB/T 9043, IEC61643-1)	40/90/21	
Marking,Red positive	Without	



Tel: +86-510-81707285

Fax: +86-510-81707277

www.jsdgame.com

DC breakdown voltage

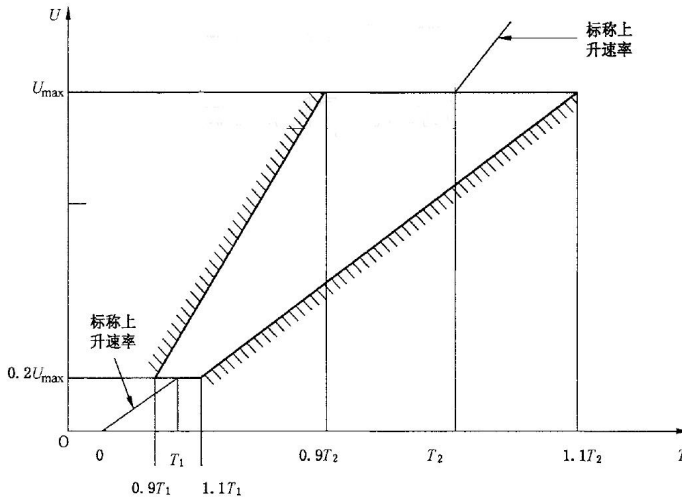

8/20us, Test wave

$T_1 = 1.25T = 8\mu s \pm 20\%$

$T_2 = 20\mu s \pm 20\%$

10/700us, Test Wave

$T_1 = 1.67T = 10\mu s \pm 20\%$

$T_2 = 700\mu s \pm 20\%$

10/1000us, Test Wave

$T_1 = 1.67T = 10\mu s \pm 20\%$

$T_2 = 1000\mu s \pm 20\%$

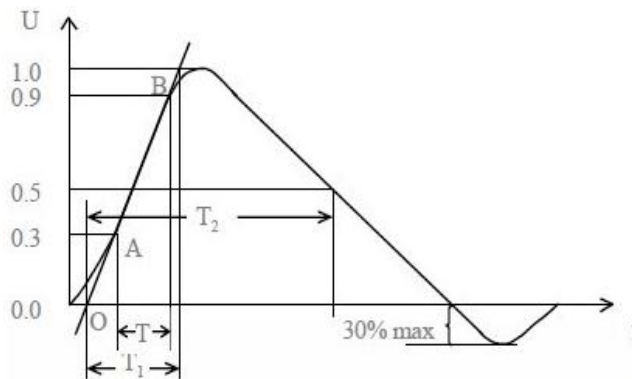

Recommended wave soldering profile

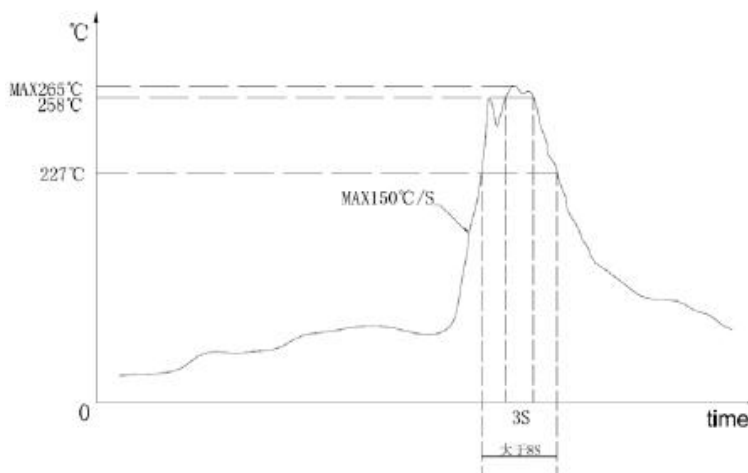

- 1) Sampling size in accordance to AQL(C=0)
- 2) DC spark-over voltage $\pm 30\%$ after load
- 3) Tests according to ITU-T Rec. K. 12 and IEC61643-1

Dimensions

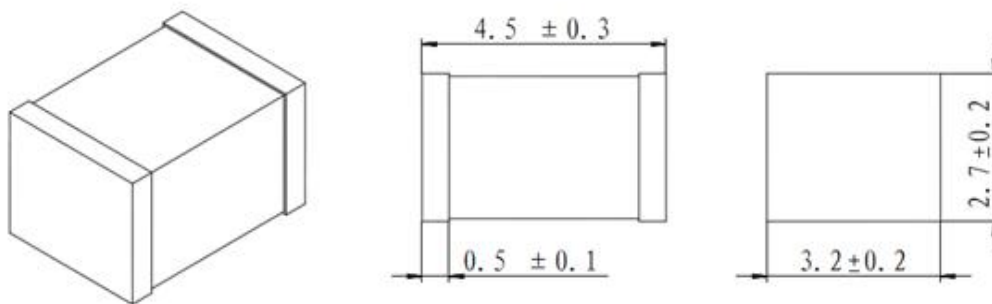

Wire Tin-plated

Packaging

One reel with 3000pcs

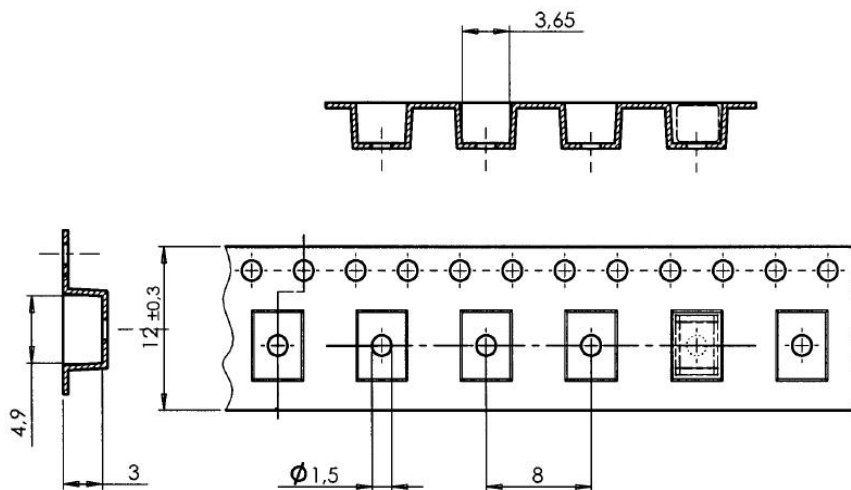

Cautions and warnings

- Surge arresters must not be operated directly in power supply networks
- Surge arresters may become hot in case of longer periods of current stress (danger of burning).
- If the contacts of the surge arrester are defective, current stress can lead to the formation of sparks and loud noises.
- Surge arresters may be used only within their specified values. In case of overload, the head contacts may fail or the component may be destroyed.
- Damaged surge arresters must not be re-used.

X-ON Electronics

Largest Supplier of Electrical and Electronic Components

Click to view similar products for [dongchen manufacturer](#):

Other Similar products are found below :

[BTA16](#) [BTB12](#) [DG3R420LFS](#) [P61089B](#) [BT137](#) [DG3R470L](#) [DG3R090M](#) [DG2R470L](#) [DG2R3000L](#) [DG2R090M](#) [DG2R350L](#) [DG2R1000L](#)
[DG301A](#) [DG3R420M](#) [DG2R2500L](#) [DG351A](#) [DG401A](#) [DG2R420M](#) [DG2R350S](#) [DG471S](#) [BTA20](#) [DG091A](#) [DG3R090L](#) [DP0640SB](#) [T810](#)
[DP3500SB](#) [DP3100SB](#) [DP0080SB](#) [DG3R230L](#) [DG2R1500L](#) [DG3R420L](#) [DG2R600L](#) [DG2R090L](#) [BTA12](#) [DG151S](#)