

linear dimension(Tolerances Standard GB/T 14486-2008)								—	∇	\perp
variable range	to 6	over 6 to 10	over 10 to 30	over 30 to 60	over 60 to 100	over 100 to 160	over 160 to	to 10	over 10 to 100	over 100 to
tolerance	±0.20	±0.30	±0.50	±0.70	±1.00	±1.30	±1.60	0.10	0.30	0.60

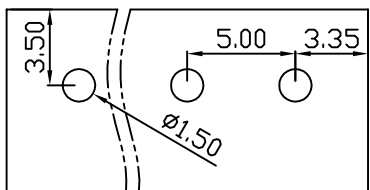

PCB Layout

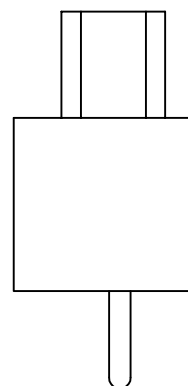
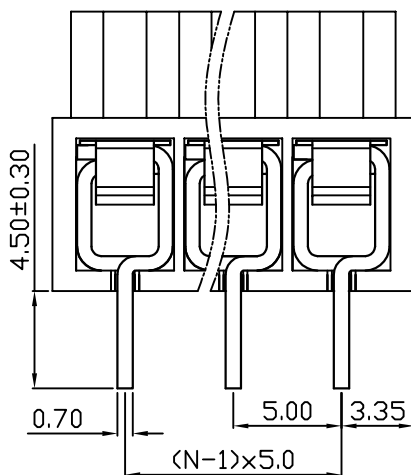
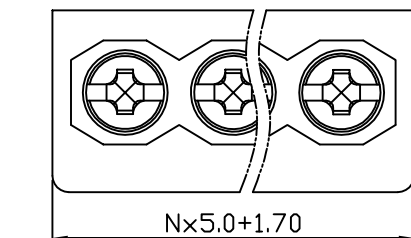
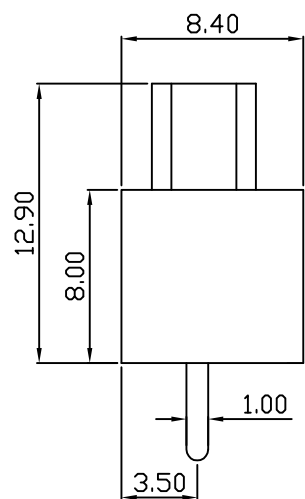

DB166 — 5.0 — XXP — C — S/P
 (Series No.) (Pitch) (Poles) Slotted/Phillips
 (Color):GN:(Green), BK:(Black), BU:(Blue), RD:(Red), GY:(Gray)
 OG:(Orange), WT:(White), YL:(Yellow), CR:(Clear)

APPD: J Ting Chen 2022.10.30
 CHKD: Duck Mao 2022.10.30
 DRFT: Steven Lu 2022.10.30

UL/CUL 技术参数		UL/CUL Technical Data		
等级	Use Group	B	C	D
额定电压	Rated Voltage [V]	300	-	300
额定电流	Rated Current [A]	15	-	10
接线范围	Wire Range	22-12		
单/多芯线	Solid/Stranded [AWG]			
耐电压	Withstanding Voltage	1600V/1Min		
IEC 技术参数		IEC Technical Data		
过电压类别	Overvoltage Category	III	III	II
污染等级	Contamination Class	3	2	2
额定电压	Rated Voltage [V]	250	400	630
额定电流	Rated Current [A]	22	22	22
额定冲击电压	Impulse withstand voltagea [KV]	4	4	4
导线截面积	Conductor cross section	2.5		
硬质/柔性导线	Solid/flexible [mm ²]			
材料		Material		
绝缘材料	Insulation Material	PA66		
阻燃等级	Imflamability	UL94V-0		
导体材料	Contact Material	铜合金 Copper alloy		
导体表面镀层	Contactive Coating	镀锡 Sn Plated		
一般参数		Other Data		
间距	Pitch [mm]	5.08		
极数	Poles [P]	02~24		
剥线长度	Stripping Length [mm]	6-7		
螺丝	Screw/扭矩 Torque(Max) [N.m]	M3/0.5		
工作温度	Operating temperatur [°C]	-40~+105		
引针尺寸	Pin Dimensions [mm]	0.70x1.00		
PCB板孔径	PCB Hole Diameter [mm]	1.50		

DORABO

宁波地博电气有限公司
 Ningbo Dorabo Electric CO., Ltd

NAME:

DB166-5.0-XXP-C-P

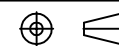

SIZE: A4

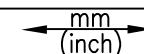

REV

T0-1

TYPE: CUSTOMER_DRAWING

SCALE: 1:1

SHEET

1/1

X-ON Electronics

Largest Supplier of Electrical and Electronic Components

Click to view similar products for [Fixed Terminal Blocks](#) category:

Click to view products by [DORABO](#) manufacturer:

Other Similar products are found below :

[MBE-1512](#) [MBE-1520](#) [MBE-154](#) [MBE-156](#) [MBES-156](#) [MH-2512](#) [MHE-132](#) [MHE-163](#) [MI-254 \(35\)](#) [MPT-275](#) [ELM10110G](#) [BA311TU](#)
[BA411SU](#) [MV-254-D](#) [MV-255](#) [MV-493](#) [MVE-252](#) [MVE-253](#) [MVEB-153](#) [1705142](#) [1-796689-8](#) [1841320000](#) [S451](#) [29.007](#) [29.116](#) [30.204](#)
[30.503](#) [30.756](#) [30.853](#) [9872-0-00-15-00-00-33-0](#) [996750](#) [1710052](#) [20020316-G071B01LF](#) [20020327-C061B01LF](#) [29590](#) [30.652](#) [30.710](#)
[30.754](#) [30.757](#) [32.058](#) [37.206](#) [37.208](#) [37.507](#) [37.558](#) [38331-5812](#) [38331-8018](#) [38540-1910](#) [39.002](#) [MBE-1517](#) [MBE-153](#)