

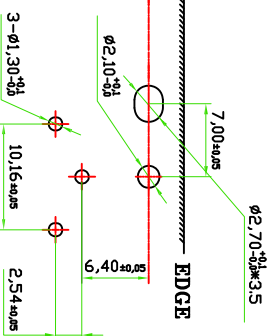

|             |             |                |            |           |
|-------------|-------------|----------------|------------|-----------|
| Product NO. |             | DOSIN-801-0212 |            |           |
| REV         | DESCRIPTION | DWN            | DATE       | APPROVEN  |
| A           | First Issue | JJM            | 2012/11/02 | John kine |

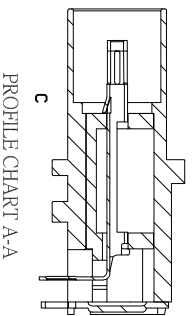
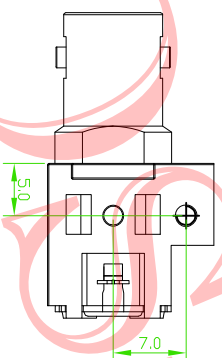
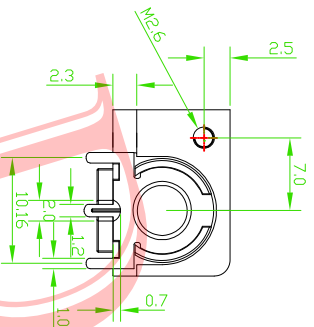
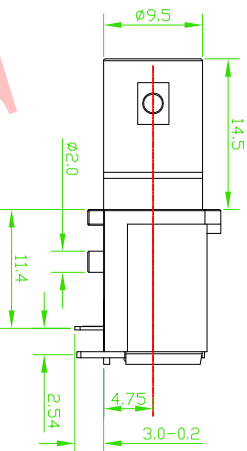
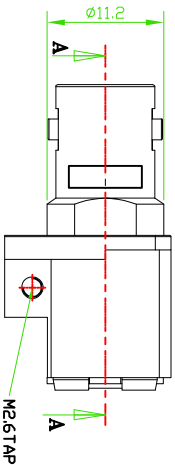
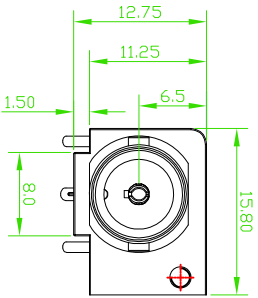

P.C.B LAYOUT

**Specifications**

Impedance: 75 Ohms  
 Frequency Range: DC~3G  
 VSWR: 1.3MAX  
 Working Voltage: 500V rms @ sea Level  
 Insulation Resistance: 5000 Ohms min  
 Temperature Range: -55°C T0 +155°C  
 Relative Temperature:  $\leq 95\%$  (40° C  $\pm 2^\circ$  C)  
 Drawings products are in line with ROHS standards

**NOTE:**

|           |             |            |           |                                  |                                                         |
|-----------|-------------|------------|-----------|----------------------------------|---------------------------------------------------------|
| DRAWN     | Zelin Zhang | 2012/11/10 | Tolerance | 0-6<br>6-30<br>30-120<br>Angular | $\pm 0.10$<br>$\pm 0.20$<br>$\pm 0.40$<br>$\pm 2^\circ$ |
| CHECKED   |             |            | View      |                                  |                                                         |
| APPROVALS | John Kine   | 12/04/2012 | UNIT      | MM                               | 1:1                                                     |

|           |             |                       |                |  |
|-----------|-------------|-----------------------|----------------|--|
| Name:     |             | BNC CONNECTOR         |                |  |
| SIZE      | Product NO. | CAD FILE              | DOSIN-801-0212 |  |
| Date/Time | 2012/11/02  | D/company drawings/BD | SHEET: 1 OF 1  |  |

**DOSIN** **Dosin Industrial(H.K)Co.Ltd**  
 东莞市德索五金电子有限公司  
**Dosin Hardware Electronics Co.,Ltd**  
 E-mail: dosin2005@163.com  
 dosin2005@dosin-china.com  
 Web: http://www.dosin.com  
 TEL: (0086) 769-81153906  
 FAX: (0086) 769-81875836

|    |             |          |        |     |  |  |
|----|-------------|----------|--------|-----|--|--|
| 4  | Cover       | BRASS    | TIN    | 1   |  |  |
| 3  | BODY        | ZINC     | NICKE  | 1   |  |  |
| 2  | PIN         | Brass    | GOLD   | 1   |  |  |
| 1  | Insulator   | PBT      | White  | 1   |  |  |
| NO | DESCRIPTION | MATERIAL | FINISH | QTY |  |  |

## X-ON Electronics

Largest Supplier of Electrical and Electronic Components

*Click to view similar products for [RF Connectors / Coaxial Connectors](#) category:*

*Click to view products by [dosinconn](#) manufacturer:*

Other Similar products are found below :

[8915-1511-000](#) [89674-0827](#) [6001-7071-019](#) [6002-7051-003](#) [6059674-1](#) [619550-1](#) [630059-000](#) [M39012/25-3026](#) [M39030/3-01N](#) [6501-1071-002](#) [6769](#) [7002-1541-010](#) [7002-1572-002](#) [7003-1542-011](#) [7004-1512-000](#) [7009-1511-004](#) [7029-1511-060](#) [7101-1541-010](#) [7101-1571-002](#) [7105-1521-002](#) [7203-1571-003](#) [7209-1511-011](#) [7210-1511-015](#) [7210-1511-040](#) [7242-1511-000](#) [73216-2241](#) [73404-2300](#) [7405-1521-005](#) [7405-1521-802](#) [7406-1521-005](#) [8527](#) [8547](#) [FS11V](#) [877931](#) [8808-1511-001](#) [9049-9513-000](#) [9074-9513-000](#) [910A205F](#) [PL40-36](#) [PL40-5](#) [PL71-9](#) [980-8666-005](#) [1200690078](#) [1-201144-1](#) [120919](#) [R107003010W](#) [R110A172100](#) [R112186000](#) [R113053000W](#) [R113081000](#)