

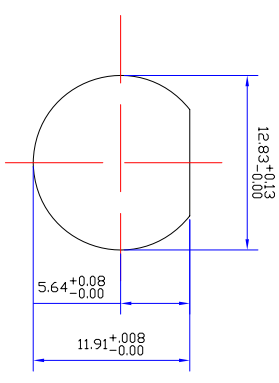

Product NO.		DOSIN-802-0016		
REV	DESCRIPTION	DWN	DATE	APPROVEN
A	First Issue	JJM	2012/11/02	John kine

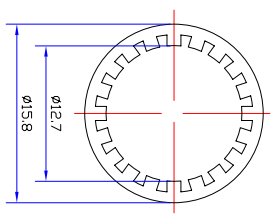
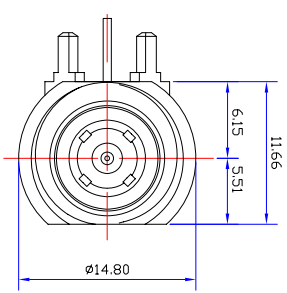
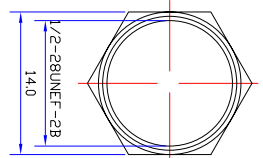
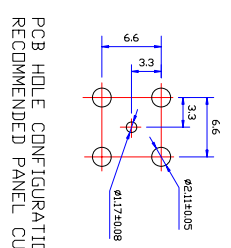
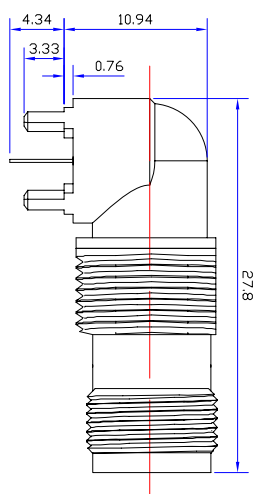
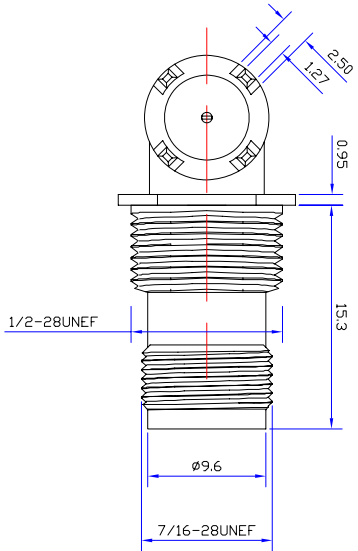

Specifications
 Frequency Range: DC~3G
 VSWR: 1.3MAX
 Working Voltage: 500V rms @ sea level
 Insulation Resistance: 5000 Ohms min
 Temperature Range: -55°C T0 +155°C
 Relative Temperature: ≤95% (40°C ±2°C)
 Drawings products are in line with ROHS standards

NOTE:

DRAWN	Zelin Zhang	2012/11/10
CHECKED		

Tolerance	0-6 6-30 30-120 Angular	±0.15 ±0.20 ±0.5 ±2°
-----------	----------------------------------	-------------------------------

Name: **TNC CONNECTOR DNN**

DOSIN Dosin Industrial(H.K)Co.Ltd
 东莞市德奈五金电子有限公司
 Dosin Hardware Electronics Co.,Ltd
 E-mail: dosin2005@163.com
 dosin2005@dosing.com
 dosin2005@dosing-china.com
 Web: http://www.dosing.com
 TEL: (0086)769-81153906
 FAX: (0086)769-81875836

3	BODY	ZINC	NICKEL	1
2	INSULATOR	POM	WHITE	1
1	PIN	BRASS	GOLD	1
NO	DESCRIPTION	MATERIAL	FINISH	QTY

APPROVALS	19/04/2012	SCALE	1:1
CHECKED		UNIT	MM
View		MM	

SIZE	Product NO.	CAD FILE	SHEET: 1 OF 1
A	DOSIN-802-0016	D/company drawings/BD	
Date/Time	2012/11/02		

X-ON Electronics

Largest Supplier of Electrical and Electronic Components

Click to view similar products for [RF Connectors](#) / [Coaxial Connectors](#) category:

Click to view products by [dosinconn](#) manufacturer:

Other Similar products are found below :

[R125315120](#) [8915-1511-000](#) [89674-0827](#) [5916-1103-603](#) [0106-001-000](#) [6-0001-3](#) [6001-7071-019](#) [6002-7051-003](#) [6002-7551-202](#) [6059674-1](#) [619550-1](#) [630059-000](#) [M39012/25-0021](#) [M39012/79-3008](#) [M39030/3-01N](#) [M39030/3-03N](#) [M3933/25-29N](#) [M3933/25-36N](#) [6500-7071-046](#) [6501-1071-002](#) [M83723/72W24576](#) [M83723/72W2457N](#) [6769](#) [CX050L2AQ](#) [7002-1541-010](#) [7003-1572-002](#) [7004-1512-000](#) [7009-1511-004](#) [7010-1511-000](#) [7029-1511-060](#) [7101-1541-010](#) [7101-1571-002](#) [7105-1521-002](#) [7145-1521-002](#) [7209-1511-011](#) [7210-1511-012](#) [7210-1511-015](#) [7210-1511-019](#) [7210-1511-040](#) [7225-1512-050](#) [7242-1511-000](#) [73137-5015](#) [73251-0111](#) [73251-0672](#) [73276-1501](#) [73366-0013](#) [73404-2300](#) [73413-6080](#) [734151610](#) [73415-5721](#)